

SECRET

2nd carbon

ANNEX A

SECRET

ORGANIZATIONAL HISTORY OF
CENTRAL INTELLIGENCE AGENCY,
1950-1953

Annexes

- A. President Truman's Letter, January 22, 1946
- B. Selected Organizational Charts of CIA and CIG, 1946-1953
- C. Directives of the National Intelligence Authority (NIA's), 1946-1947
- D. CIA Legislation of 1947, 1949, and 1951
- E. NSC Intelligence Directives and NSI Directives, 1947-1953
- F. List of OIC Projects, 1951-1953
- G. Missions and Functions of CIA Offices, 1950-1953
- H. List of ORR Reports, 1952-1953
- K. Descriptive List of ORR Estimates projects, 1950-1953
- L. List of OSI Projects, 1949-1953
- M. List of IAC Projects, 1950-1953
- N. Index to Text (Chapters I to K)

President Truman's Letter,

January 22, 1946

January 22, 1946

To the Secretary of State,
The Secretary of War, and
The Secretary of the Navy.

1. It is my desire, and I hereby direct, that all Federal foreign intelligence activities be planned, developed and coordinated so as to assure the most effective accomplishment of the intelligence mission related to the national security. I hereby designate you, together with another person to be named by me as my personal representative, as the National Intelligence Authority to accomplish this purpose.

2. Within the limits of available appropriations, you shall each from time to time assign persons and facilities from your respective Departments, which persons shall collectively form a Central Intelligence Group and shall, under the direction of a Director of Central Intelligence, assist the National Intelligence Authority. The Director of Central Intelligence shall be designated by me, shall be responsible to the National Intelligence Authority, and shall sit as a non-voting member thereof.

3. Subject to the existing law, and to the direction and control of the National Intelligence Authority, the Director of Central Intelligence shall:

- a. Accomplish the correlation and evaluation of intelligence relating to the national security, and the appropriate dissemination within the Government of the resulting strategic and national policy intelligence. In so doing, full use shall be made of the staff and facilities of the intelligence agencies of your Departments.
 - b. Plan for the coordination of such of the activities of the intelligence agencies of your Departments as relate to the national security and recommend to the National Intelligence Authority the establishment of such over-all policies and objectives as will assure the most effective accomplishment of the national intelligence mission.
 - c. Perform, for the benefit of said intelligence agencies, such services of common concern as the National Intelligence Authority determines can be more efficiently accomplished centrally.
 - d. Perform such other functions and duties related to intelligence affecting the national security as the President and the National Intelligence Authority may from time to time direct.
4. No police, law enforcement or internal security functions shall be exercised under this directive.
 5. Such intelligence received by the intelligence agencies of your Departments as may be designated by the National Intelligence Authority shall be freely available to the Director of

Central Intelligence for correlation, evaluation or dissemination. To the extent approved by the National Intelligence Authority, the operations of said intelligence agencies shall be open to inspection by the Director of Central Intelligence in connection with planning functions.

6. The existing intelligence agencies of your Departments shall continue to collect, evaluate, correlate and disseminate departmental intelligence.

7. The Director of Central Intelligence shall be advised by an Intelligence Advisory Board consisting of the heads (or their representatives) of the principal military and civilian intelligence agencies of the Government having functions related to national security, as determined by the National Intelligence Authority.

8. Within the scope of existing law and Presidential directives, other departments and agencies of the executive branch of the Federal Government shall furnish such intelligence information relating to the national security as is in their possession, and as the Director of Central Intelligence may from time to time request pursuant to regulations of the National Intelligence Authority.

9. Nothing herein shall be construed to authorize the making of investigations inside the continental limits of the United States and its possessions, except as provided by law and Presidential directives.

10. In the conduct of their activities the national Intelligence Authority and the Director of Central Intelligence shall

be responsible for fully protecting intelligence sources and
methods.

Sincerely yours,

/s/ Harry Truman

SECRET

2nd carbon

ANNEX B

SECRET

ANNEX B

SELECTED ORGANIZATIONAL CHARTS OF CIG AND CIA,

1946-1953

Contents

<u>General Organizational Charts, 1946-1953</u>	Tab 1
CIG "Tentative" Organization, July 22, 1946	
CIG Organization, November 22, 1946	
CIG Organization, July 1, 1947	
CIA Organization, October 15, 1947	
CIA Organization, January 1, 1949	
CIA Organization, July 1, 1950	
CIA Organization, October 1, 1950	
CIA Organization, December 1, 1950	
CIA Organization, January 19, 1951	
CIA Organization, March 20, 1953	
<u>Charts of ORE and Predecessors, 1946-1950</u>	Tab 2
Organization of Central Reports Staff, 1946	
Organization of Office of Research and Evaluation, July 22, 1946 (see "general" chart in Tab 1 above)	
Organization of Office of Reports and Estimates, as of November 22, 1946, July 1, 1947, October 15, 1947, January 1, 1949, July 1, 1950 (see "general" charts in Tab 1 above)	
Organization of ORE, October 19, 1949	
<u>Charts Showing Proposed Reorganizations of ORE, September-November 1950</u>	Tab 3
Proposed Assistant Director for Intelligence Production, September 27, 1950	
Proposed Assistant Director for Research and Reports, October 31, 1950	
Proposed Deputy Director for National Estimates, November 8, 1950	

*Copies of all known charts of the Agency as a whole, from its origins as CIG in 1946 to its development by 1953, are included in this compilation, in Tab 1. The charts on the individual offices (Tabs 2 to 11) are limited, however, to those illustrating major changes. Furthermore, the charts for the covert-operations offices are omitted entirely, except that their changing organization is usually shown in the "general" charts, in Tab 1. For the statements of missions and functions of the individual offices, which frequently accompanied the officially published charts, see Annex C, below, for the period 1950-1953.

SECRET

<u>Charts of the Office of National Estimates, 1950-1953</u>	Tab 4
ONE as of December 1, 1950	
ONE as of January 19, 1951	
ONE as of March 20, 1953	
<u>Charts of the Office of Research and Reports, 1950-1953</u>	Tab 5
ORR as of December 1, 1950	
ORR as of January 19, 1951	
ORR as of March 20, 1953	
<u>Charts of the Office of Current Intelligence, 1951-1953</u>	Tab 6
OCI as of 1951	
OCI as of March 20, 1953	
<u>Charts of the Office of Scientific Intelligence, 1949-1953</u>	Tab 7
(For Scientific Branch, CRE, November 22, 1946, July 1, 1947, and October 15, 1947, see general charts, Tab 1)	
OSI as of about January 29, 1949	
OSI as of February 7, 1949	
OSI as of February 9, 1950	
OSI as of July 1, 1950 (see general charts, Tab 1)	
OSI as of November 1, 1950	
OSI as of December 1, 1950	
OSI as of January 19, 1951	
OSI as of March 20, 1953	
OSI in relation to the Government's entire scientific-intelligence organization, December 1, 1950	
<u>Charts of the Office of Collection and Dissemination and Its Predecessors, 1946-1953</u>	Tab 8
Office of Collection, July 22, 1946	
Office of Dissemination, July 22, 1946	
Reference Branch and Center, CRE, November 22, 1946 (see under CRE, in general charts, Tab 1)	
Reference Center, CIA Executive, October 15, 1947 (see under Executive in general charts, Tab 1)	
OCD as of January 1, 1949, July 1, 1950 (see general charts, Tab 1)	
OCD as of December 1, 1950	
OCD as of January 19, 1951	
OCD as of May 27, 1951	
OCD in 1951	
OCD as of March 20, 1953	
<u>Charts of the Office of Operations, 1950-1953</u>	Tab 9
OO as of December 1, 1950	
OO as of January 19, 1951	
OO as of March 20, 1953	

Chart of the Office of Intelligence Coordination,
January 19, 1951

Tab 10

Charts of Administrative and Support Offices, 1950-1953

Tab 11

(For period 1946-1950, see under CIA Executive
in general charts, Tab 1)

Office of the Executive as of November 13, 1950

DD/A's group as of January 19, 1951, April 18, 1951,
and March 20, 1953

Assistant DD/A for Administration, December 1, 1950
Security Organization

Office of the Chief, Inspection and Security, 1950
Security Office (Assistant to Deputy for Security),
December 1, 1950

Assistant Deputy (Inspection and Security),
January 19, 1951

Assistant Deputy (Inspection and Security),
April 18, 1951

Assistant Deputy (Inspection and Security), 1951

Security Officer, CIA, March 20, 1952

Director of Security, March 20, 1953

Finance Organization

Finance Division as of December 1, 1950

Finance Office as of January 19, 1951

Comptroller's Office as of March 20, 1953

Personnel Organization

Personnel Division as of December 1, 1950

Personnel Office as of January 19, 1951

Personnel Office as of March 20, 1953

Procurement Organization

Procurement Division as of December 1, 1950

Procurement Office as of January 19, 1951

Logistics Office as of March 20, 1953

Administrative Services Offices

Administrative Services Division, December 1, 1950

Administrative Services Office, January 19, 1951

General Services Office as of March 20, 1953

Medical Organization

Medical Staff table of organization, September 21, 1950

Medical Division as of December 1, 1950

Medical Office as of January 19, 1951

Medical Office as of October 1952

Medical Office as of March 20, 1953

Training Office (under O/DCI)

Training Office as of July 1, 1951

OTR as of about June 1952

Office of Training as of March 20, 1953

Communications Office

O/Commo in DD/P Group, December 1, 1950 and
July 1, 1951

O/Commo under O/DCI, March 20, 1953

ORGANIZATION CHART - CIB 227/76
(Continued)

NATIONAL INTELLIGENCE AUTHORITY
SECRETARY OF STATE
SECRETARY OF THE NAVY
FEDERAL REPRESENTATIVE OF
THE PRESIDENT

CONFIDENTIAL

DIRECTOR OF CENTRAL INTELLIGENCE

Prepared to exercise the full direction and control of N.I.A., the National Intelligence Agency, as defined in the President's directive of 22 January 1949 and as amended by the N.I.A.

1. Acts as a non-voting member of the National Intelligence Authority.
2. Directs all activities of the Central Intelligence Group.
3. Coordinates, evaluates and disseminates intelligence and national policy intelligence within the government.
4. Plans for coordination of intelligence activities related to national security and for the execution of intelligence activities to accomplish national intelligence mission.
5. Performs special operations as directed by the President and the N.I.A.

Assists the Director in the discharge of his functions and acts for him in his absence.

DEPUTY DIRECTOR

SECRETARIAT

Performs personal secretarial services for the Director of Central Intelligence and acts as a temporary office of record.

INTERDEPARTMENTAL COORDINATING AND PLANNING STAFF

1. The Interdepartmental Coordinating and Planning Staff acts for the Director of Central Intelligence in the coordination of all interdepartmental activities and in the preparation of recommendations regarding the establishment of overall policies and plans to assure the most effective cooperation of the national intelligence mission.
2. In discharging these responsibilities this staff will maintain liaison with the various departments and individuals concerned. It will focus its activities on the coordination of the intelligence activities of the Central Intelligence Group, its various departments and individuals concerned, to assure that discharge its responsibilities.
3. The facilities of each activity are adequate to adequately discharge its responsibilities.
4. The facilities of the Central Intelligence Group are operated in accordance with the policies and procedures of the various departments and individuals concerned.
5. Raw information from all sources and activities is received by the Central Intelligence Group and, where appropriate, is disseminated to the various departments and individuals concerned.
6. The intelligence requirements of the State, War, Navy and other governmental departments and individuals concerned are adequately met.
7. Methods, procedures and controls are adequate within the Central Intelligence Group and the State, War, Navy and other governmental departments and individuals concerned to insure the prompt dissemination of strategic and national policy intelligence.

EXECUTIVE OFFICE

Functions as a staff for the Director of Central Intelligence in performing the normal office administrative and securing the activities of the Central Intelligence Group.

SECRETARIAL INTELLIGENCE SUPPORT

Performs secretarial services for the Director of Central Intelligence and acts as a temporary office of record.

OFFICE OF SPECIAL OPERATIONS

Asst. Director for Special Operations
1. The agency responsible for the performance of special operations assigned to the Director of Central Intelligence, by the N.I.A.

OFFICE OF COLLECTION

Asst. Director for Collection
1. Acts for the Director of Central Intelligence in the collection of foreign intelligence information required for the production of strategic and national policy intelligence and national security of the United States.
2. In close coordination with appropriate agencies of other governmental departments, describes the intelligence information required for the production of strategic and national policy intelligence and national security of the United States.

OFFICE OF RESEARCH AND EVALUATION

Asst. Director for Research and Evaluation
1. The agency of the Director of Central Intelligence responsible for the production of strategic and national policy intelligence and national security of the United States.
2. In close coordination with appropriate agencies of other governmental departments, describes the intelligence information required for the production of strategic and national policy intelligence and national security of the United States.

OFFICE OF DISTRIBUTION

Asst. Director for Distribution
The agency of the Director of Central Intelligence responsible for the dissemination of intelligence information to the various departments and individuals concerned by the Office of Research and Evaluation, Central Intelligence Group.

CONFIDENTIAL

22 JULY 1945

SECRET

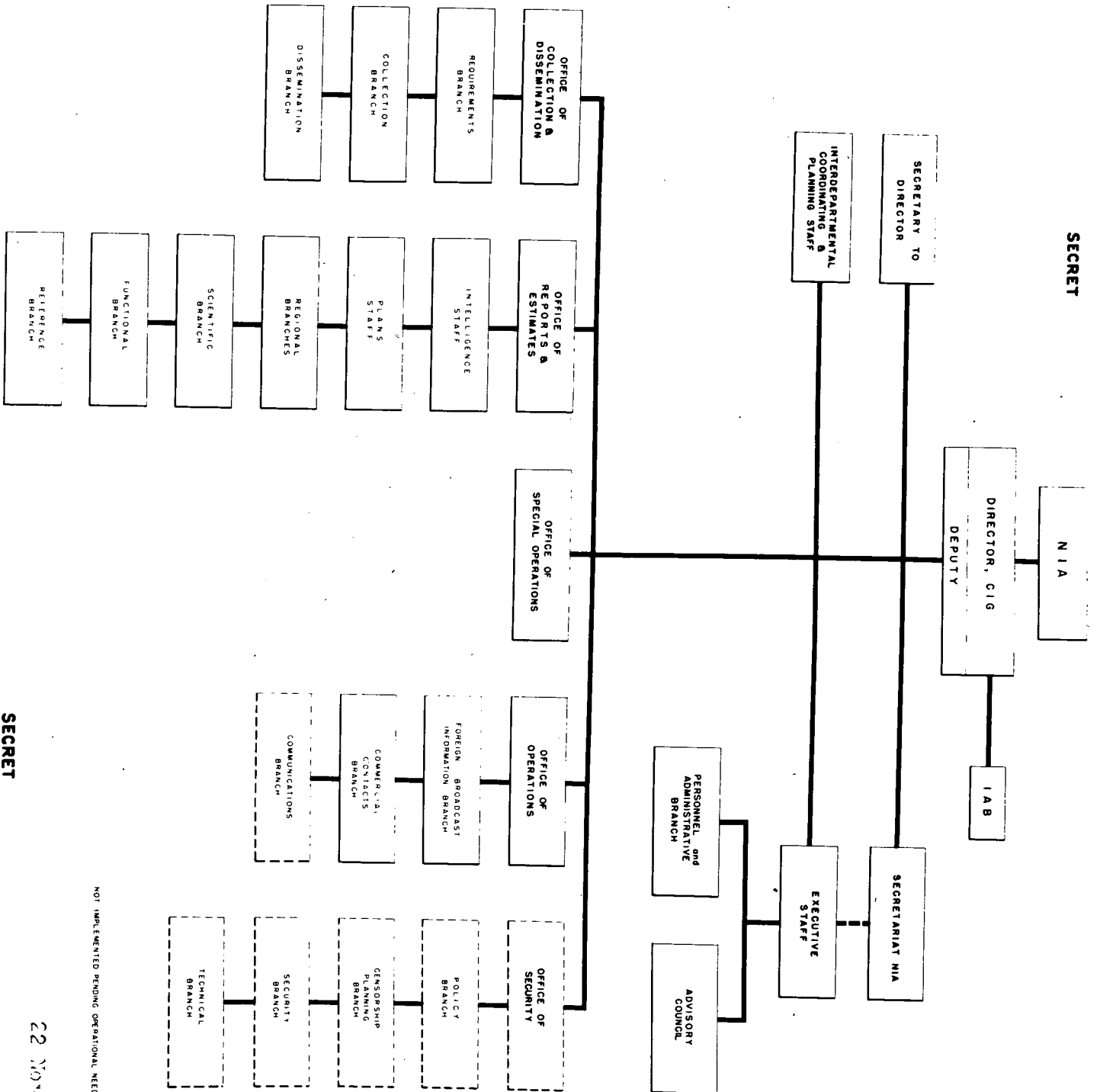

NOT IMPLEMENTED PENDING OPERATIONAL NEED

SECRET

22 Nov 1961

1946

SECRET

CIG Organization - 1 July 1947

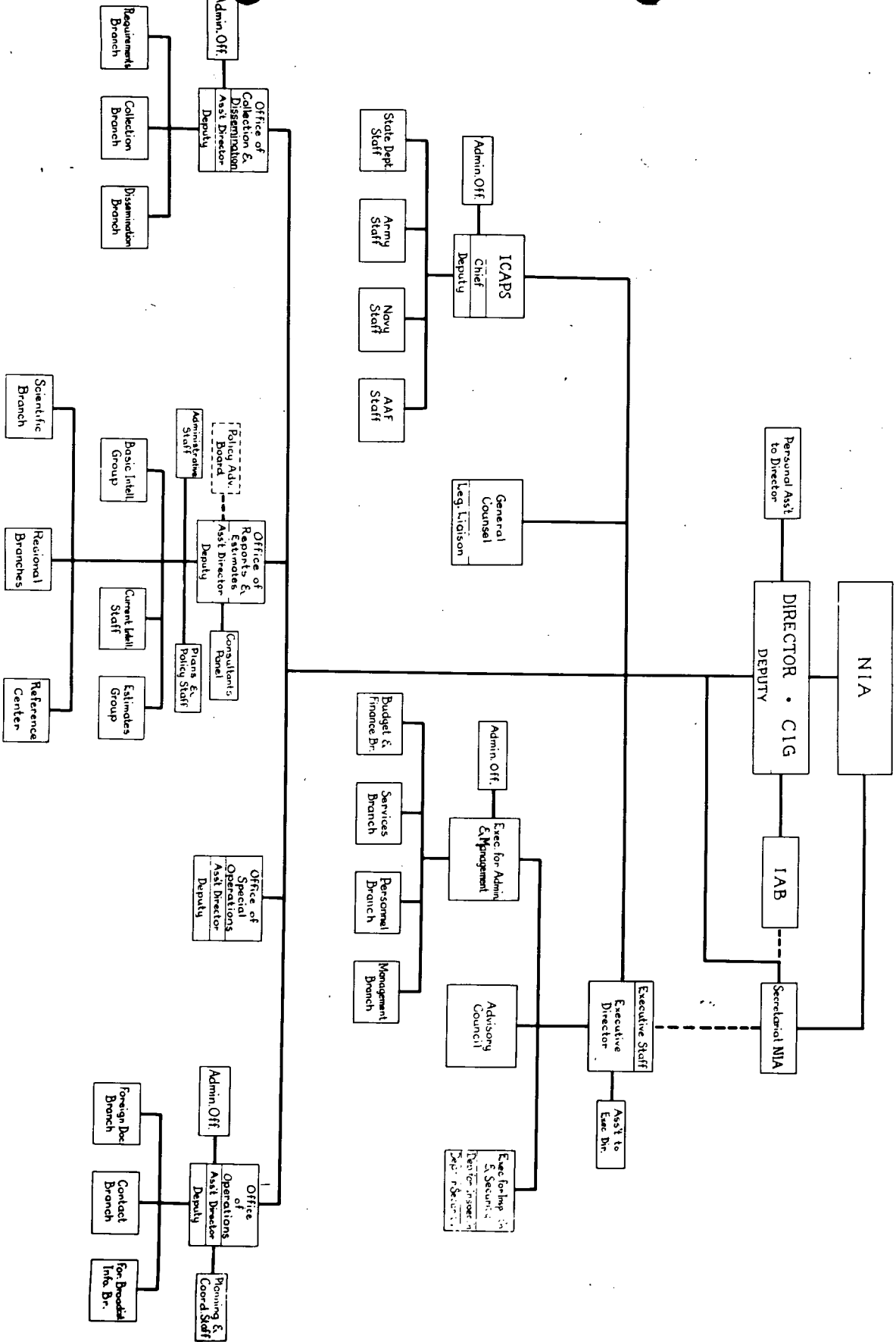

SECRET

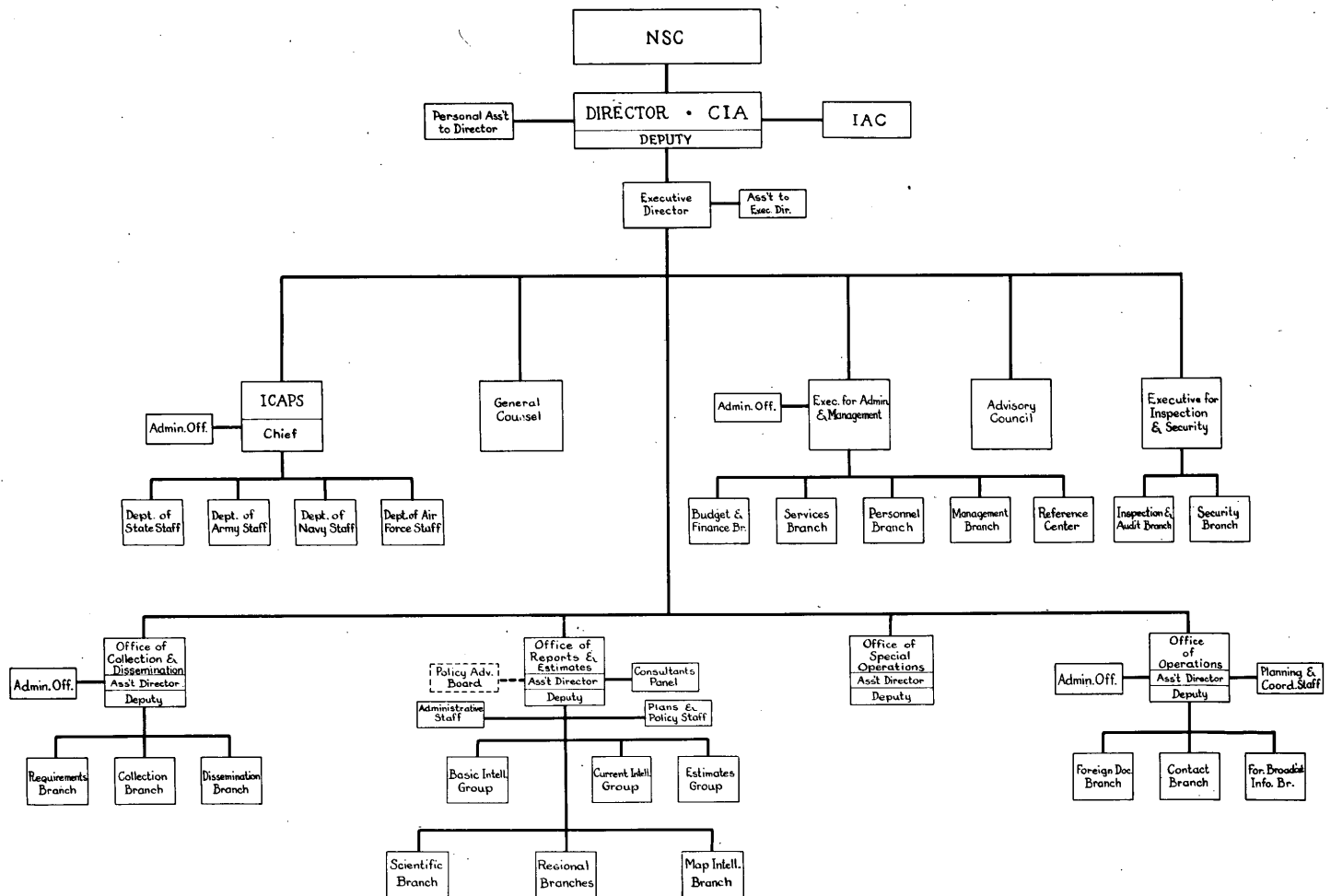

CIA Organization

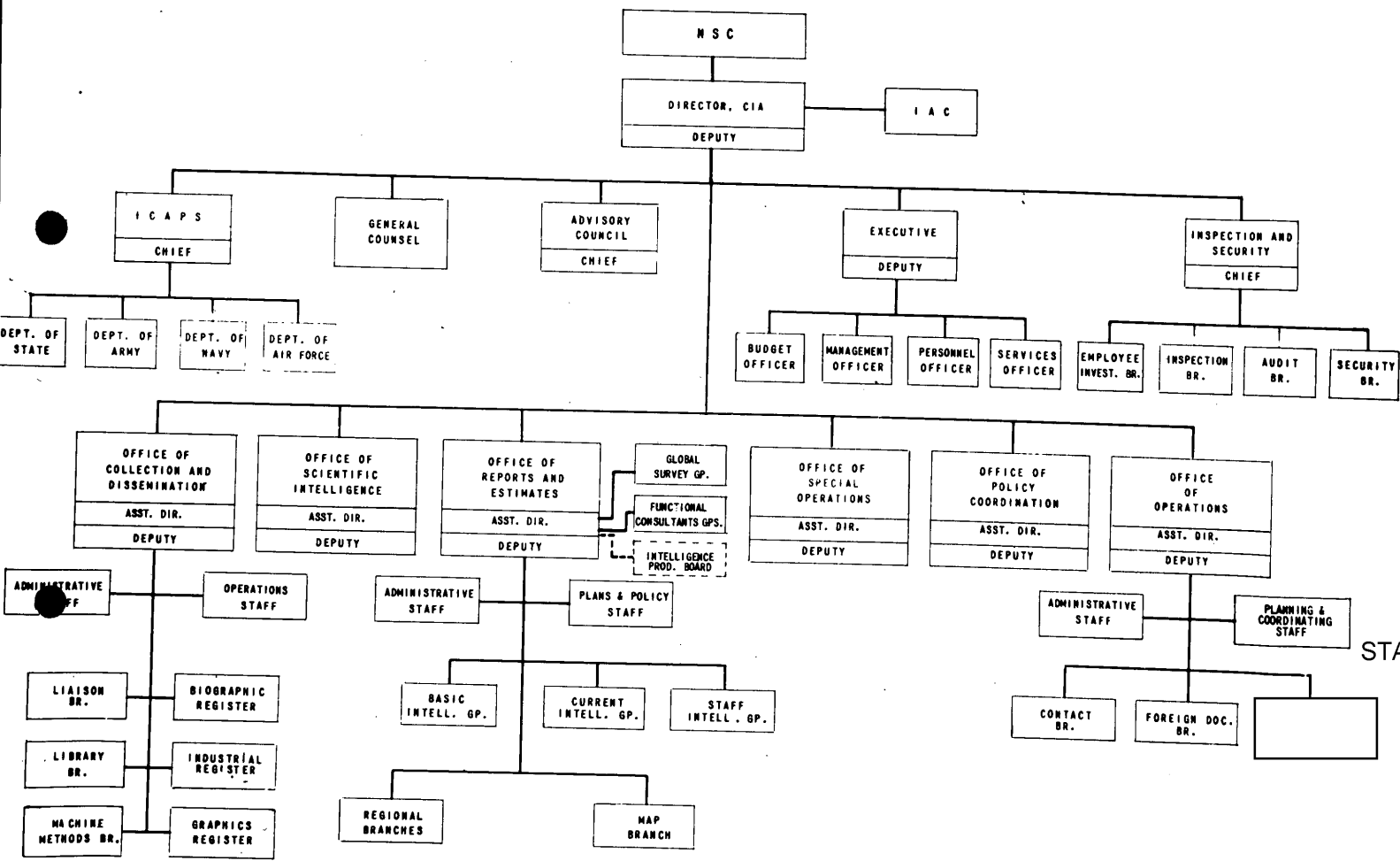

CENTRAL INTELLIGENCE AGENCY

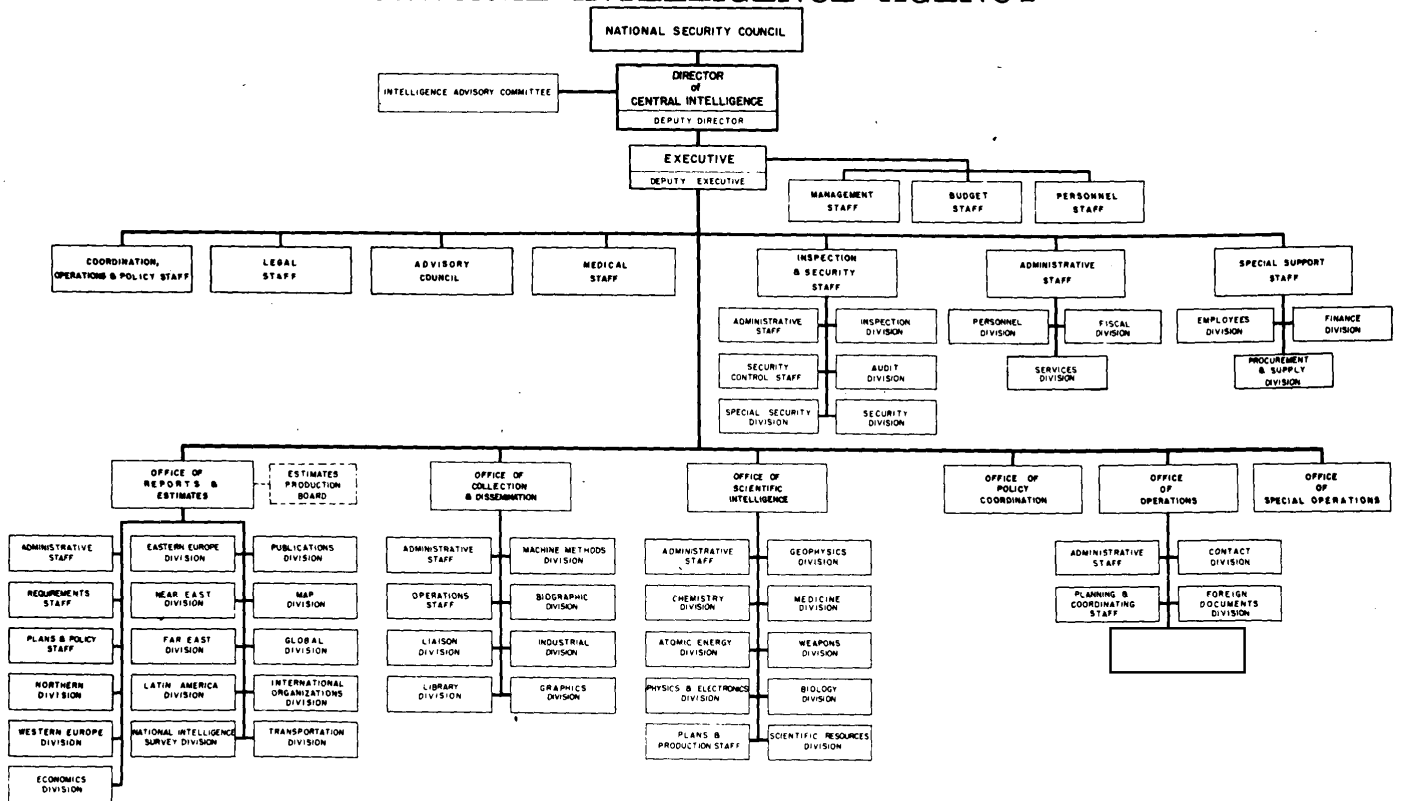

CENTRAL INTELLIGENCE AGENCY

SECRET

(Organization as of 1 October 1950)

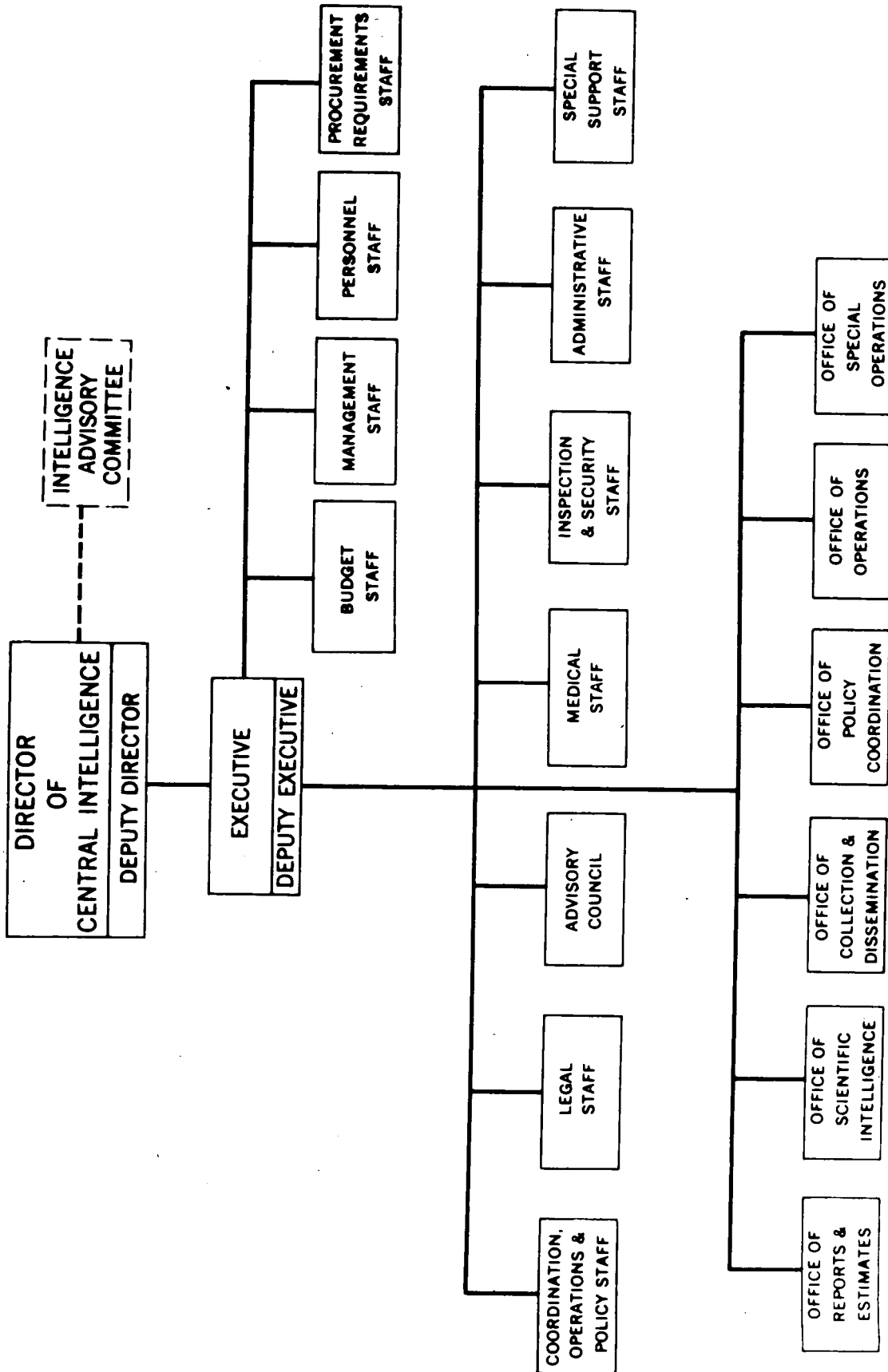

GR 1119 CIA. 12-51

SECRET
SECURITY INFORMATION

SECRET
CENTRAL INTELLIGENCE AGENCY

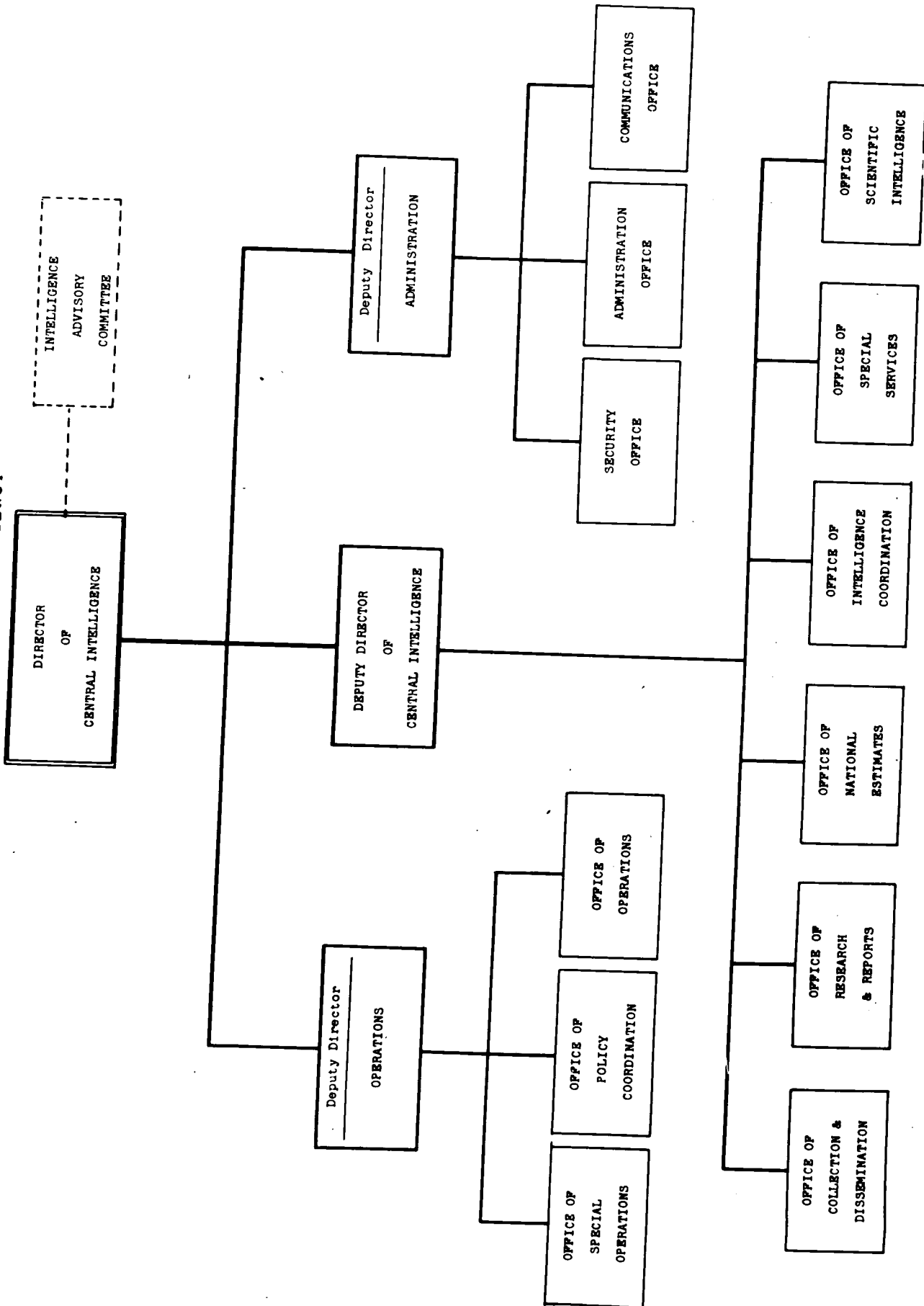

1 DECEMBER 1950

SECRET

CENTRAL INTELLIGENCE AGENCY

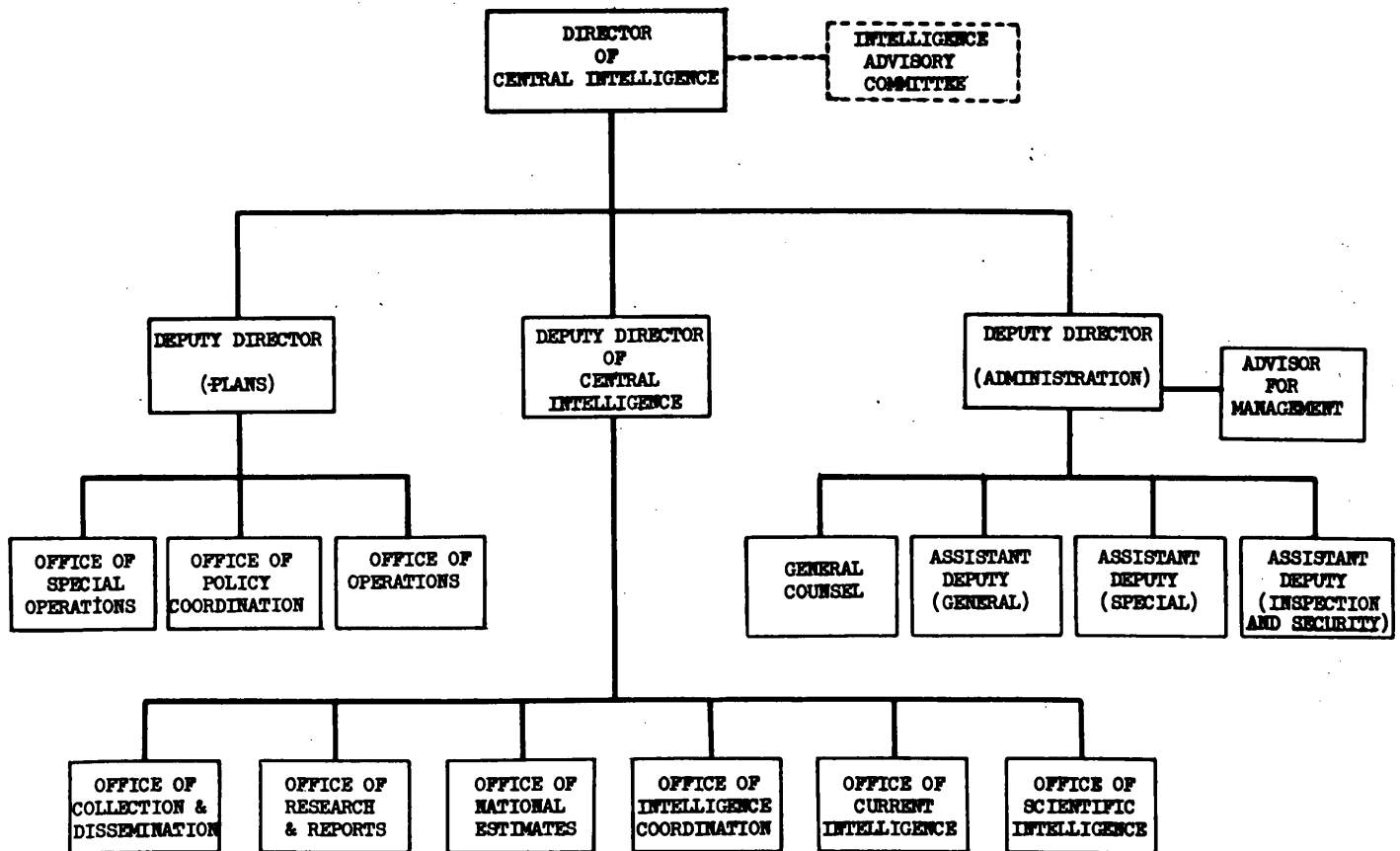

CENTRAL INTELLIGENCE AGENCY

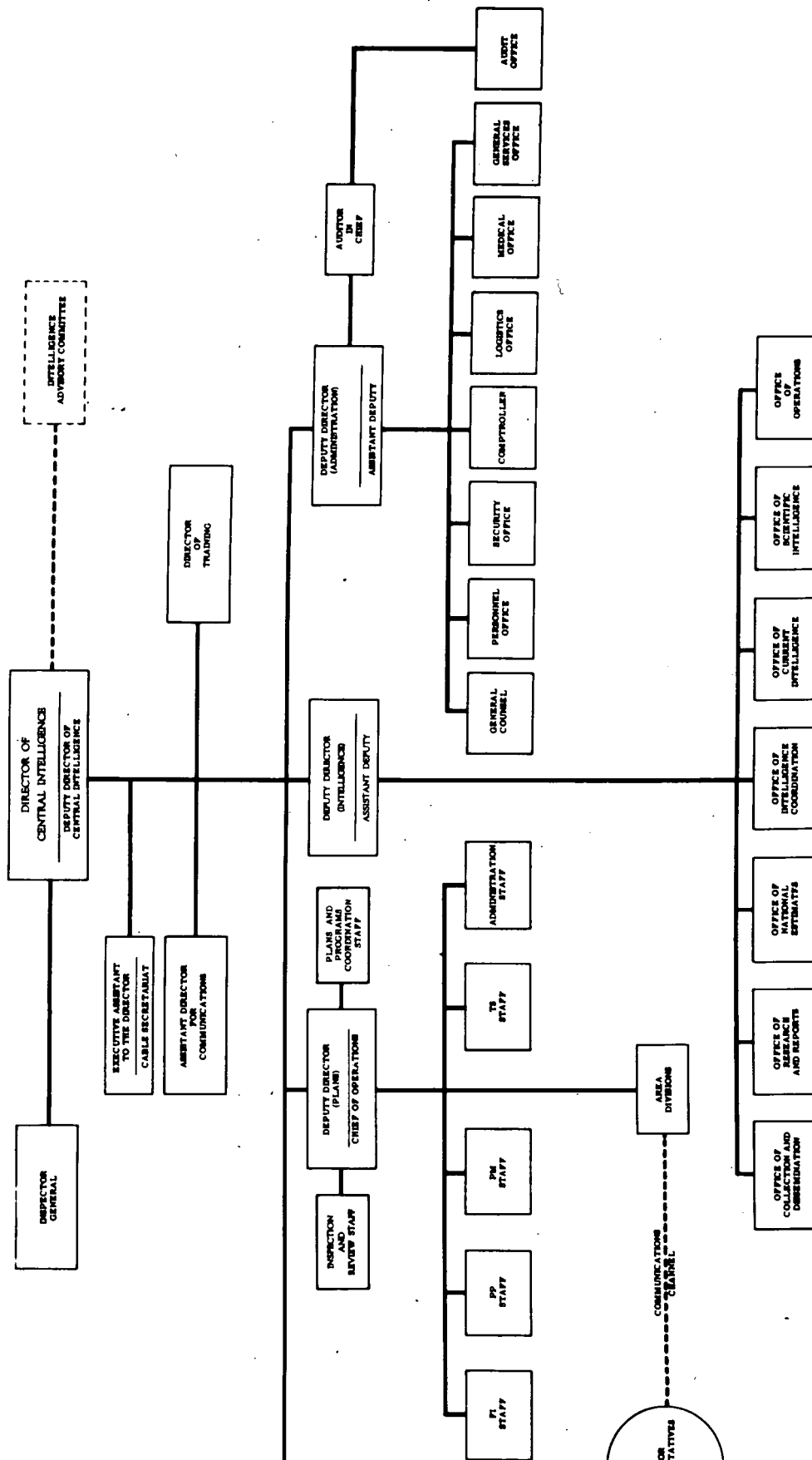

Approved For Release 2002/08/28 : CIA-RDP64-00654A000200070001-3

Approved For Release 2002/08/28 : CIA-RDP64-00654A000200070001-3

CONFIDENTIAL

CENTRAL REPORTS STAFF

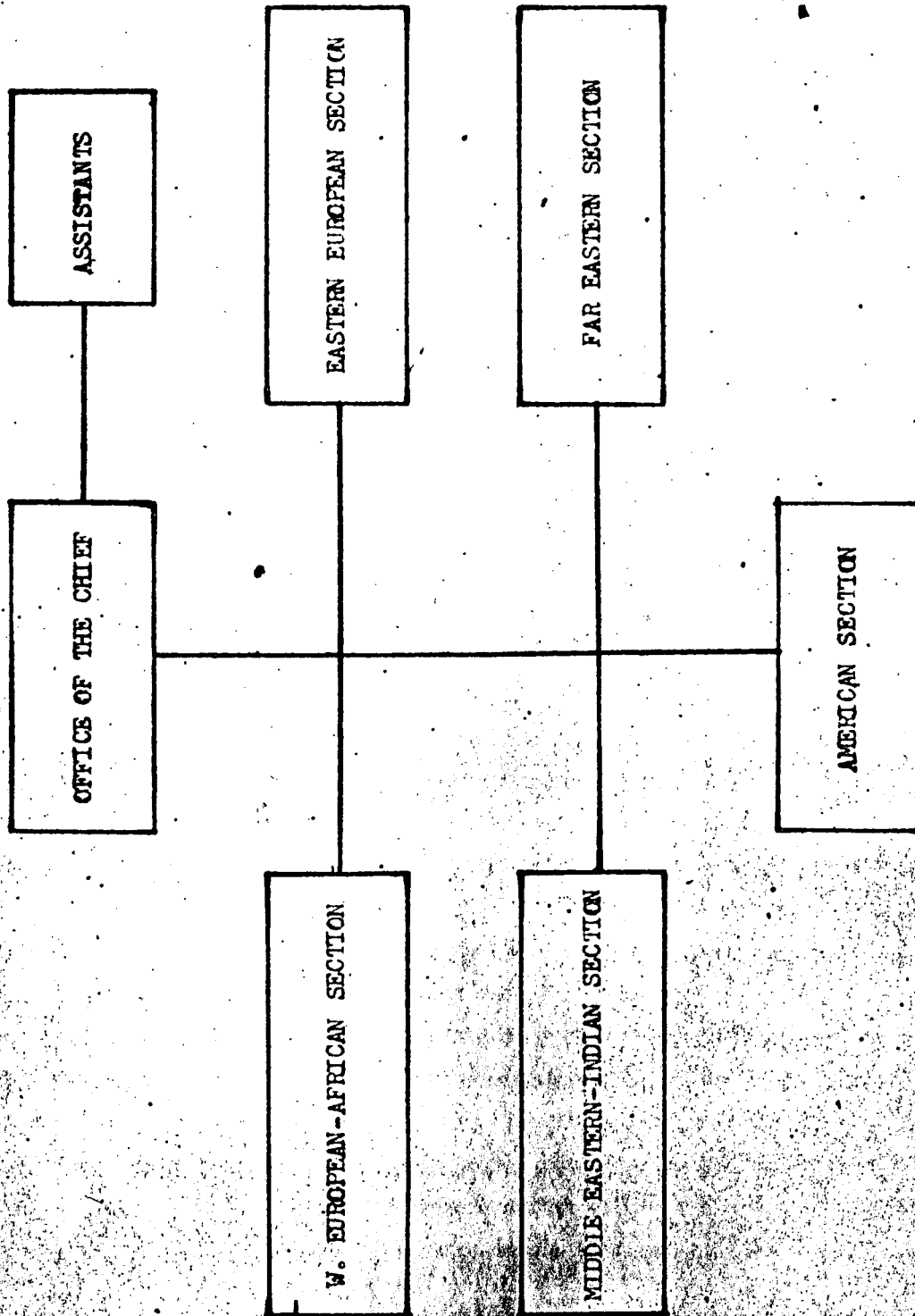

CONFIDENTIAL

SECRET

ORGANIZATION CHART FOR THE OFFICE OF REPORTS AND ESTIMATES

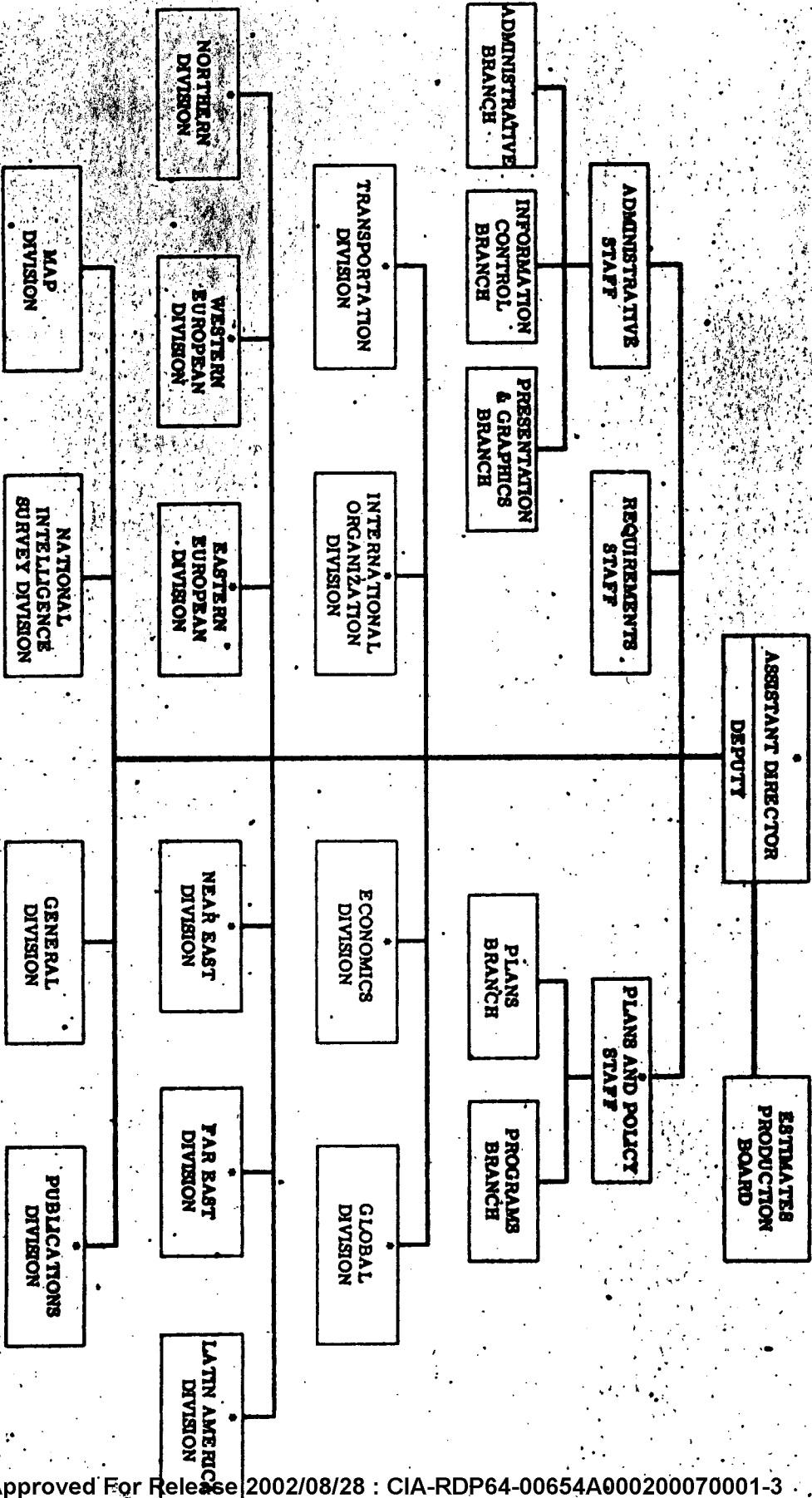

* Indicates membership on the Estimates Production Board.

Oct. 1949

16
 from ORR Reorganization - Jan 1951 folder in HQ files. This is attached to ORR Reorg. #6
 "M.I. 2" also in ORR Reorg. #6
 SECRET

ASSISTANT DIR
FOR
INTELLIGENCE PR
DEPUTY (CHIEF, PR

EXECUTIVE

NON-SOV
WEST DIV.

SOV-ORBIT
DIV.

NON-SOV
EAST DIV.

ESTIMATES
BRANCH

ESTIMATES
BRANCH

ESTIMATES
BRANCH

NORTH EUROPE
& CANADA BR.

POLITICAL
BRANCH

JAPAN/KOREA
BRANCH

WESTERN EU-
ROPE BR.

ECONOMIC
BRANCH

CHINA
BRANCH

NEAR EAST-
AFRICA BR.

SOCIOLOGICAL
BRANCH

S. E. ASIA
BRANCH

LATIN AMERI-
CA BRANCH.

PSYCHOLOGICAL
BRANCH

INDIA-PAKIS-
TANI/AFGHAN B.

SUPPORT
BRANCH

MILITARY
BRANCH

PACIFIC OCEAN
AREAS BR.

SUPPORT
BRANCH

SUPPORT
BRANCH

SECRET

RECTOR
 PRODUCTION
 (MOD. STAFF)

PRODUCTION STAFF



SCIENTIFIC
 DIVISION

INTERNAT'L
 FUNCTIONAL DIV.

INTELLIGENCE
 SUPPORT DIV.

BAC. WRF. BR.

INT'L ORG. B.		
UN	COMM'NTE	T&C

BASIC INTEL. BR.	
MIS	RESEARCH

CHEMICAL BR.

INT. ECONOMIC B.		
TRANS	TRADE FIN.	AG.

GEOGRAPHIC BR.		
INTEL	MAP	CARTO

MEDICAL BR.

INTERNAT'L PSY- CHOLOGICAL BR.		
-----------------------------------	--	--

REFERENCE BR.	
REGISTR.	LIBRARY

PHYS & ELECTR. B.

ATOMIC EN. BR.

GEOPHYSICAL B.

SCIENTIFIC RES. B.

WEAPONS
 BRANCH

NOTE: EACH REGIONAL BRANCH OF THE NON-SOV DIVISIONS WILL CONTAIN FOUR FUNCTIONAL SECTIONS: POLITICAL, ECONOMIC, PSYCHOLOGICAL & MILITARY. EACH FUNCTIONAL BRANCH OF THE SOV-ORIG DIV WILL CONTAIN TWO REGIONAL SECTIONS: USSR & SATELLITE, EXCEPT THE POLITICAL BRANCH WHICH WILL HAVE AN ADDITIONAL SECTION FOR INTERNATIONAL COMMUNISM

SECRET

ORE 27 SEP 50

16

SECRET

AD/R#R
DEPUTY

PRODUCTION STAFF

EXECUTIVE

PLANS
COORD

REQM
DIV.

SAC
DIV.

REPT
DIV.

ECONOMIC
DIVISION

SCIENTIFIC
DIVISION

PSYCHOLOGICAL
DIVISION

GEOGRAPHIC
DIVISION

OPERATIONAL
DIVISION

REFERENCE
DIVISION

SOV-CRB

BACWARFARE

SOV-CRB

EVALUATION

CHECKLIST

CIA USES

NON-SOY-WEST

CHEMICAL

NON-SOY-WEST

CARTOGRAPHY

MILITARY

FORG & LIA

NON-SOY-EAST

MEDICAL

NON-SOY-EAST

LIBRARY

INT. COMAN

BIOG. RECS

INT. FINANC

ATOMIL ENG

WARFARE

CONTENTIAN

INDUST G

TRANSITION

PHYS. REJECT

FUNCTIONAL

SPECL. PROJ

GRAPHIC RE

WARFARE

GEOPHYSICAL

GRAPHIC PRES

MACH RECS

SCIENTIFIC RE

WEAPONS

SECRET

31 OCTOBER 1964

Handwritten notes and signatures at the bottom right of the page.

PROPOSED REORGANIZATION OF CIA'S INTELLIGENCE OFFICES
November 8, 1950 *

DEPUTY DIRECTOR
FOR
NATIONAL
ESTIMATES

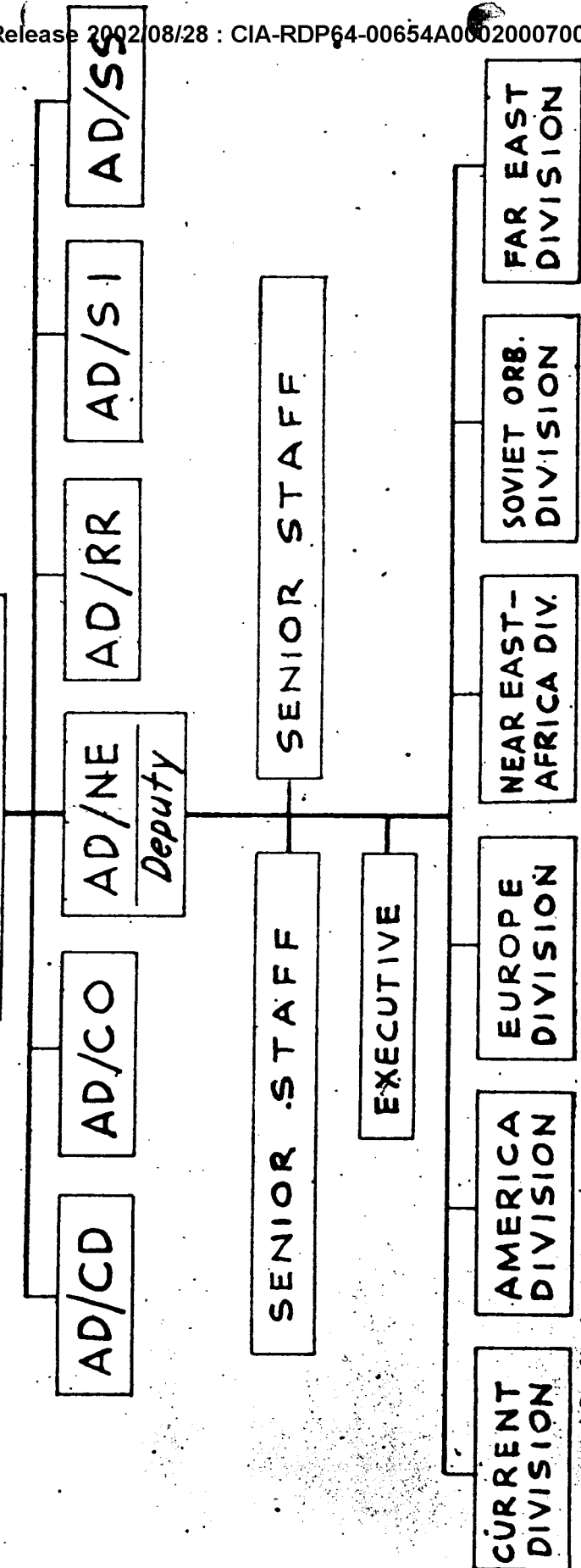

* Draft chart in DD/S file, "O&N-5"

TAB
ved For F

SECRET

OFFICE OF NATIONAL ESTIMATES

ASSISTANT DIRECTOR FOR
NATIONAL ESTIMATES

NATIONAL ESTIMATES
BOARD

NATIONAL
ESTIMATES
STAFF

INTELLIGENCE
SUPPORT
STAFF

SECRET

SECRET

OFFICE OF NATIONAL ESTIMATES

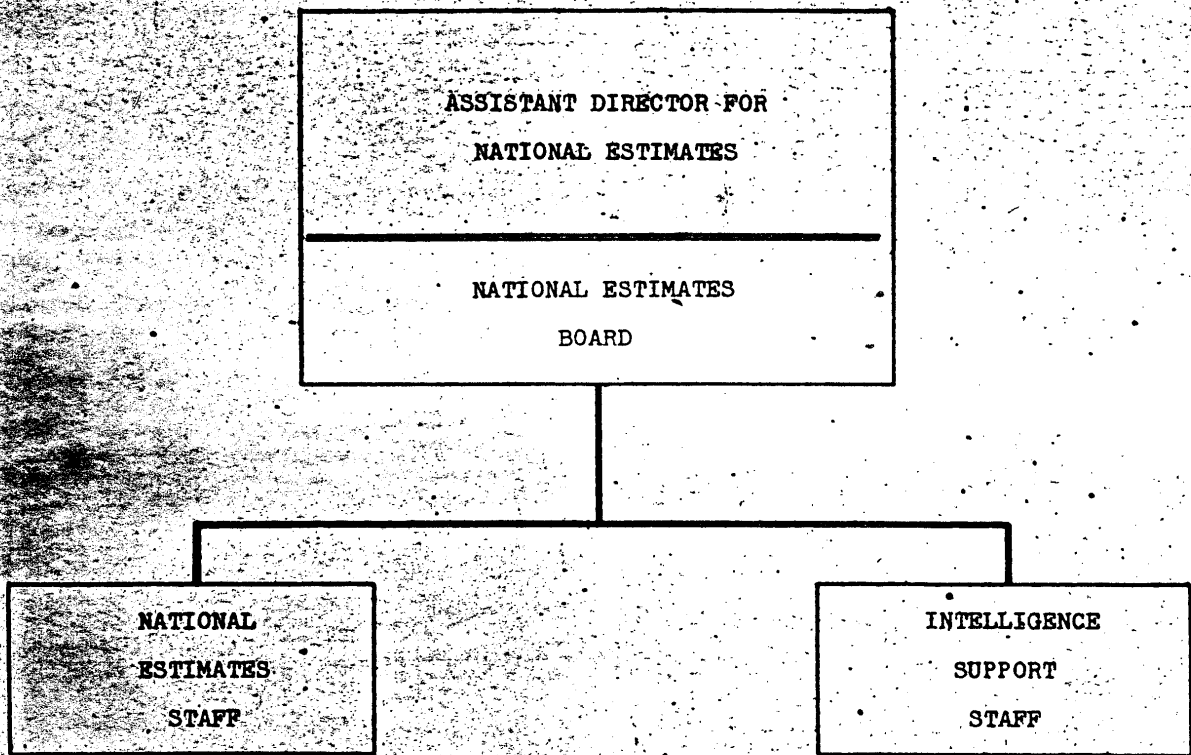

25X1

SECRET

19 January 1951

R 1-130
(Figure 4)

25 March 1953

SECRET
Security Information

OFFICE OF NATIONAL ESTIMATES

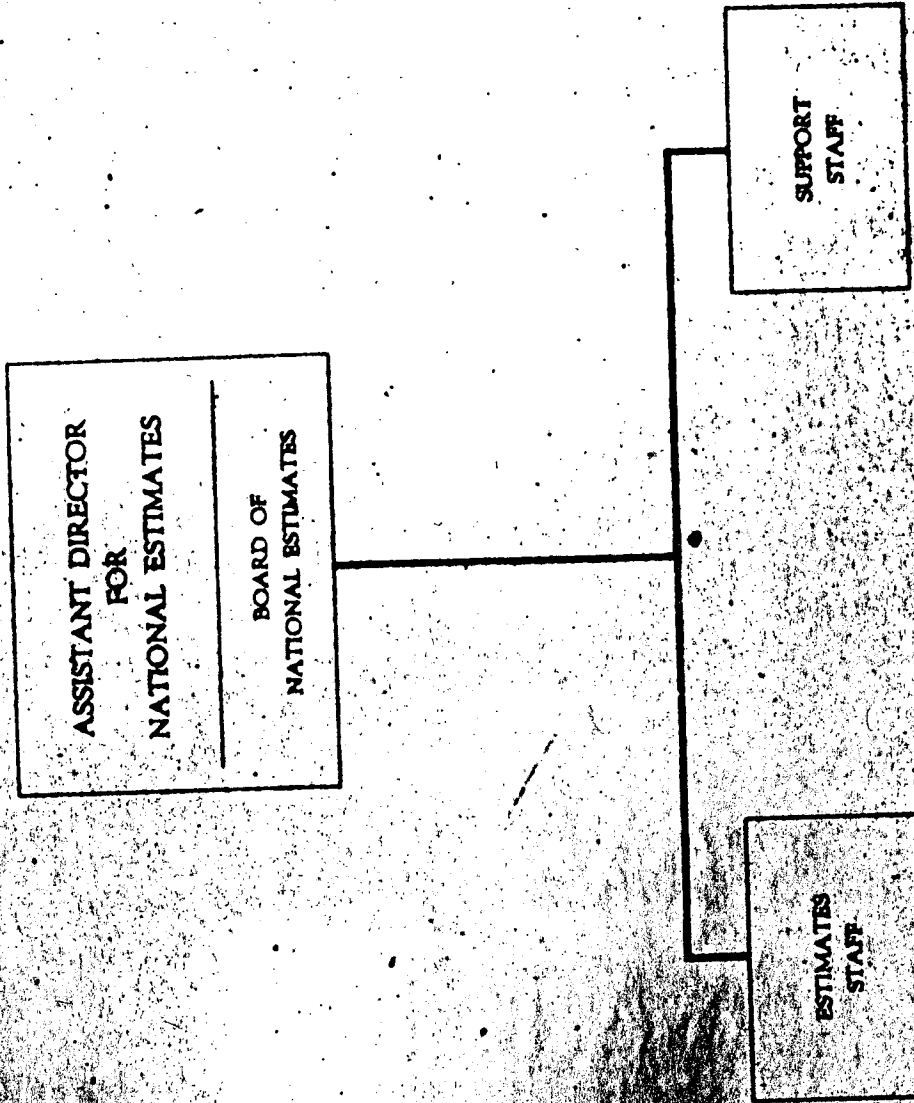

SECRET

Dec. 1, 1950 9

SECRET

OFFICE OF RESEARCH & REPORTS

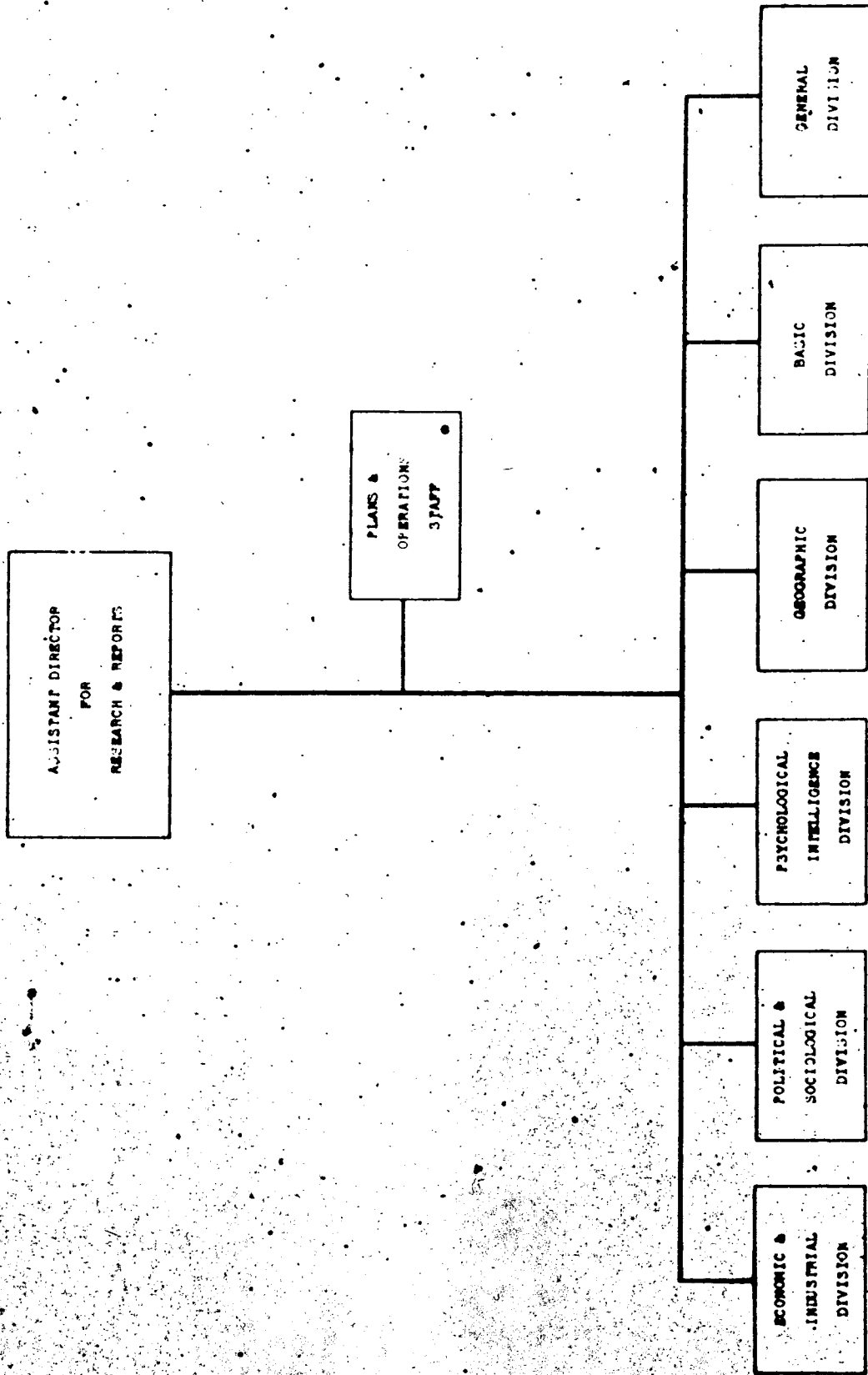

SECRET

SECRET

OFFICE OF RESEARCH & REPORTS

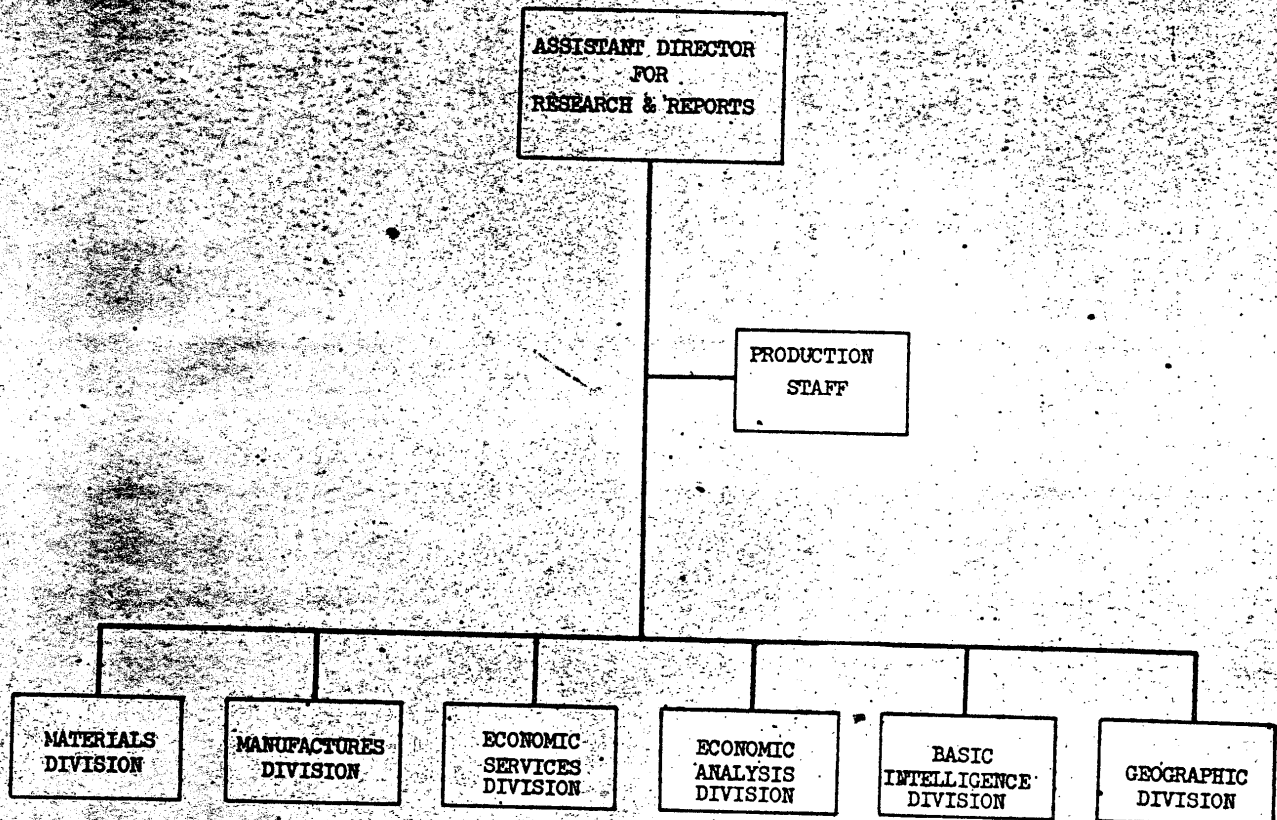

25X1

SECRET

19 January 1951

SECRET

Security Information

R 1-130
(Figure 3)
20 March 19

OFFICE OF RESEARCH AND REPORTS

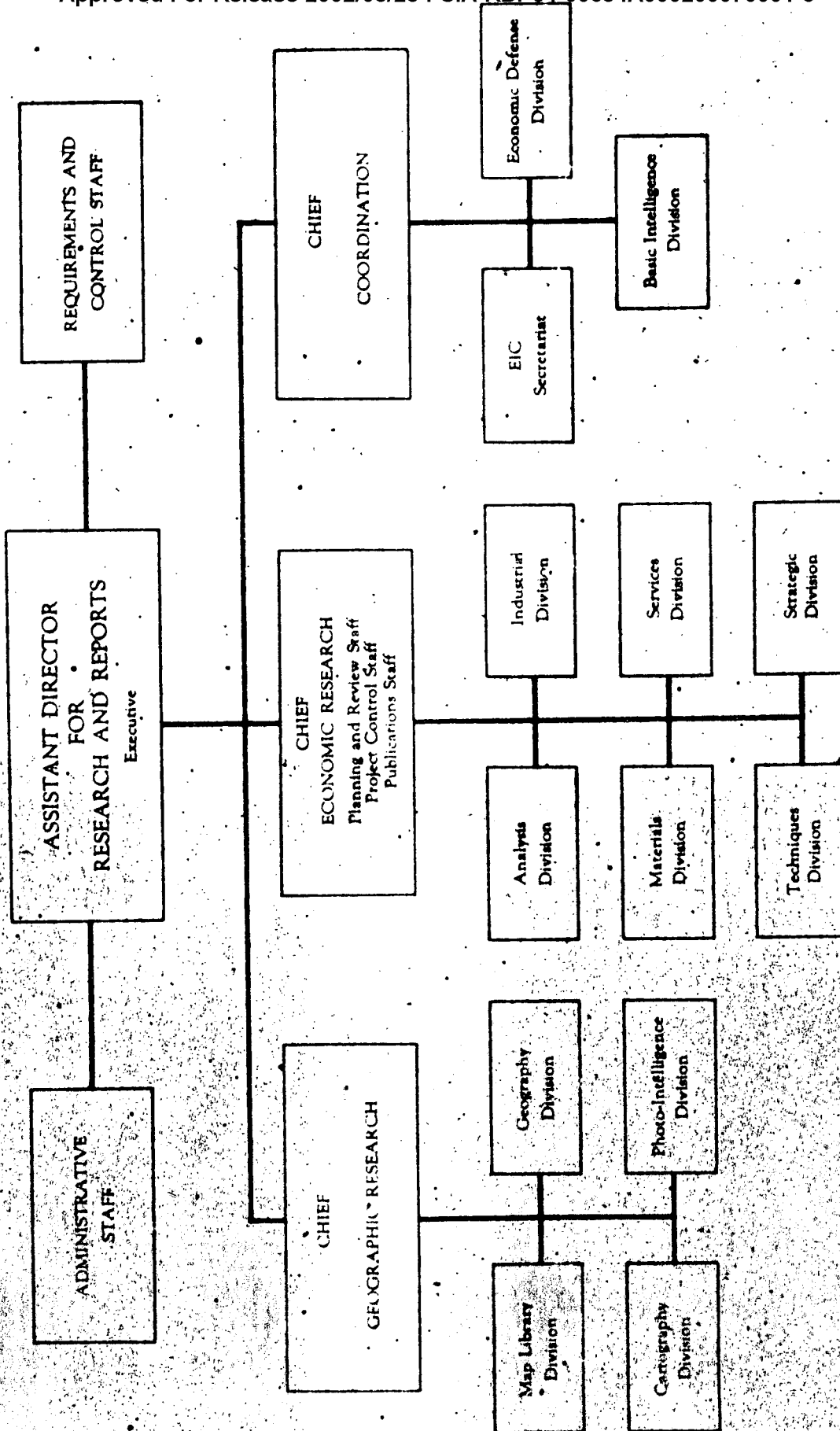

SECRET

SECURITY INFORMATION

1951

ORGANIZATION CHART, OFFICE OF CURRENT INTELLIGENCE

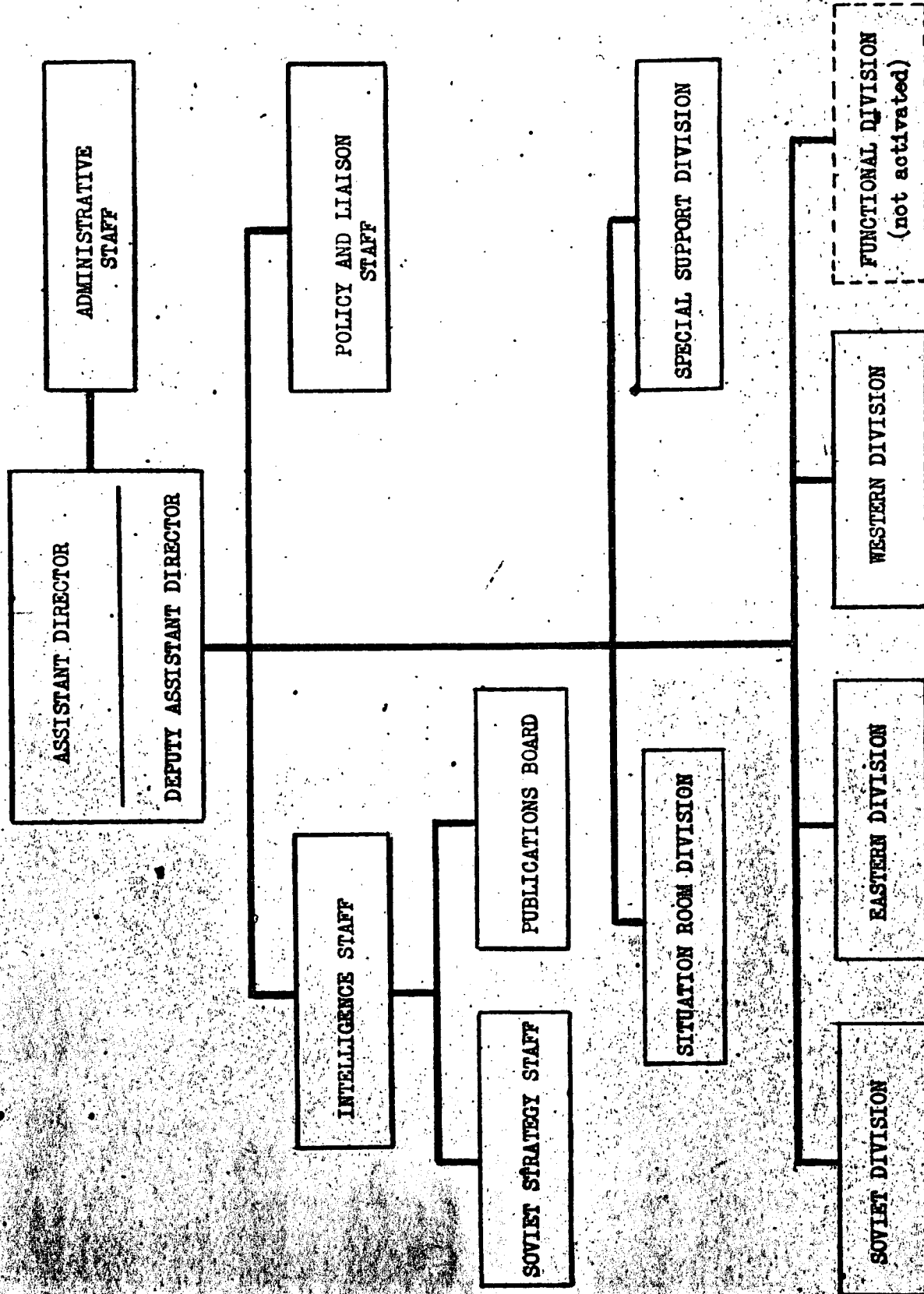

SECRET
Security Information

OFFICE OF CURRENT INTELLIGENCE

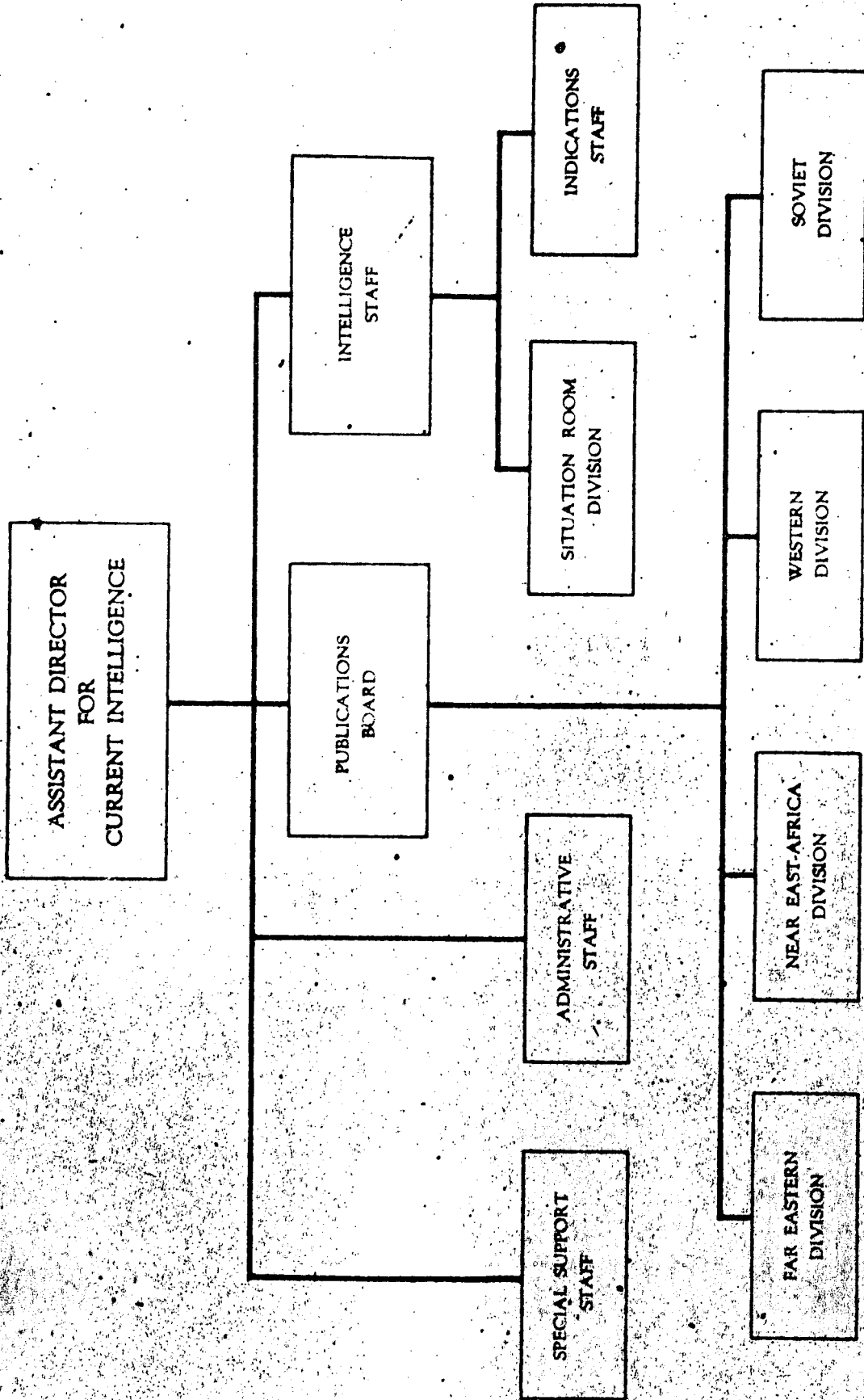

SECRET

*In a folder in SI, Miami and Junction
the chart was clipped to a
statement of [unclear] [unclear]
dated 26 January 1949.
cf. Nest of OIC, 1912, 13-2*

SECRET
SECURITY INFORMATION

ORGANIZATION OF OSI 1949

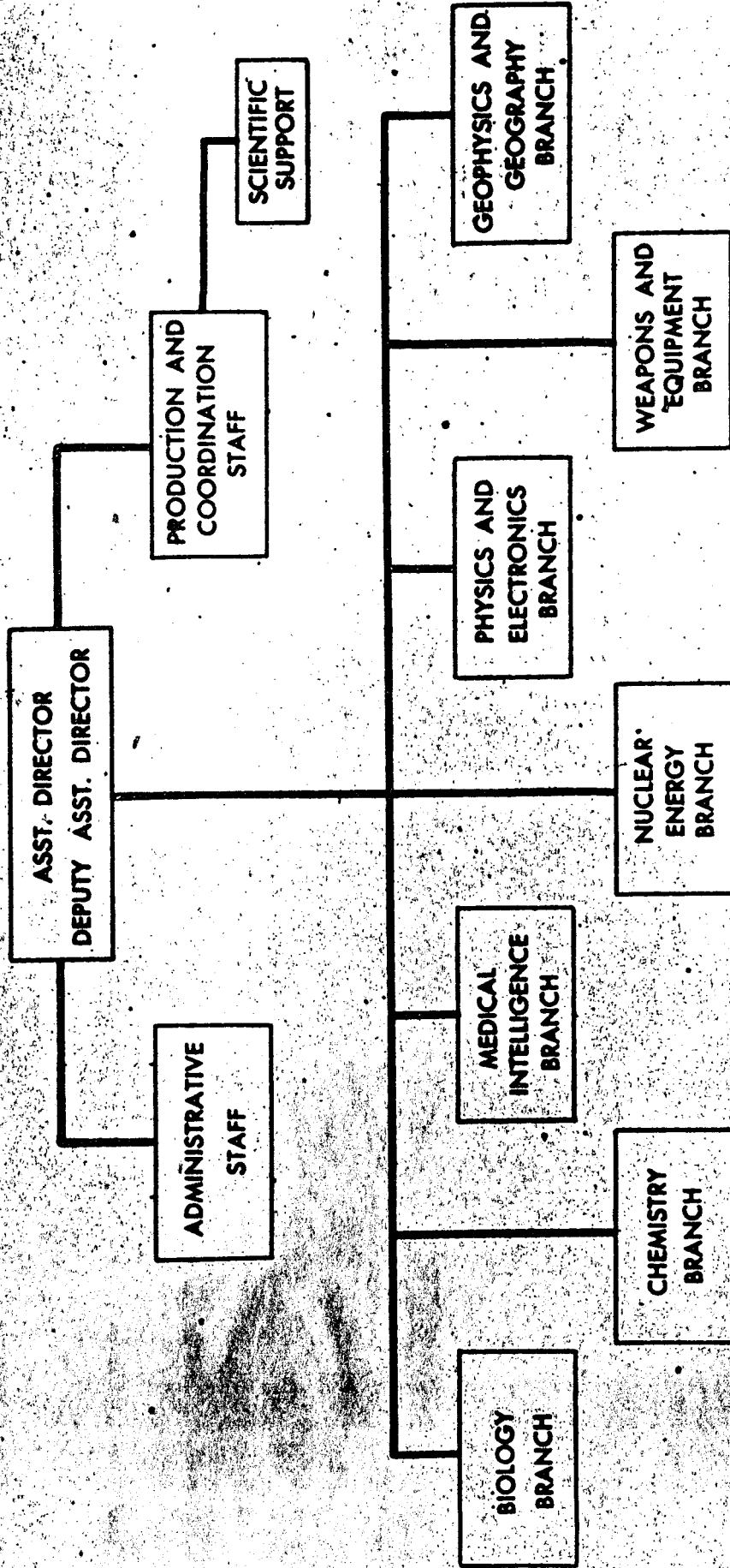

SECRET

Chart - Jan 29, 1949

SECRET

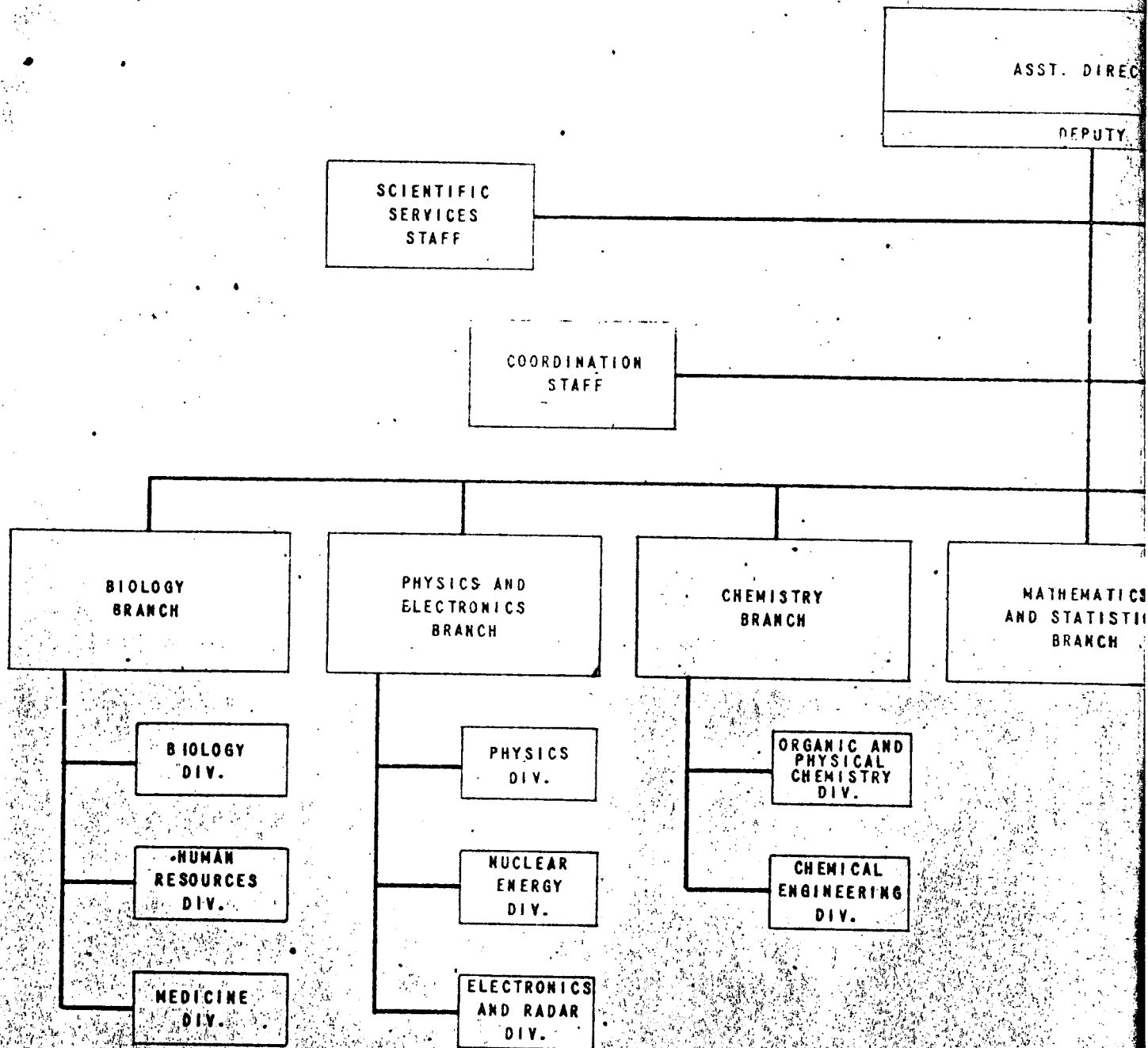

SECRET

SECRET

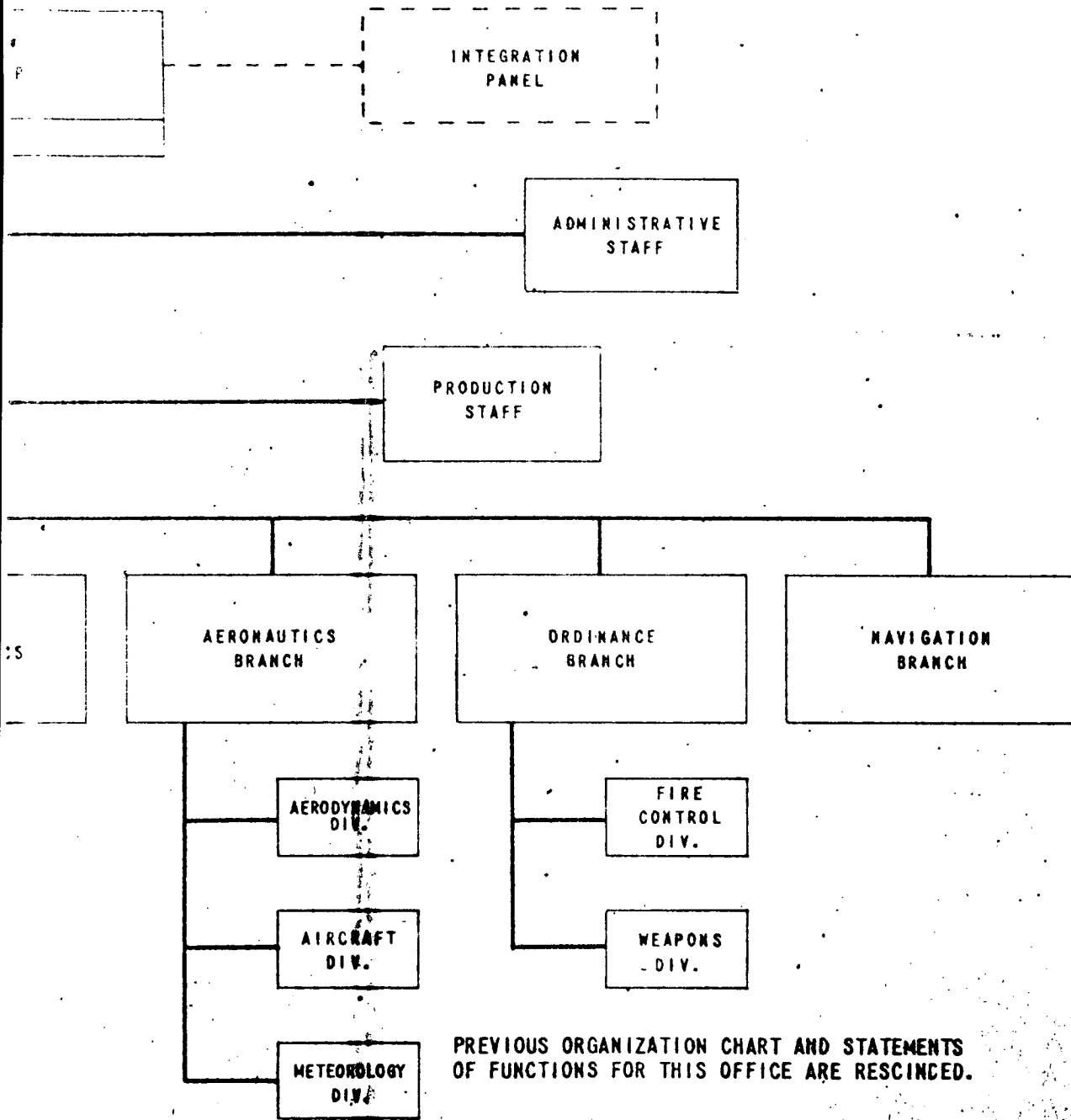

PREVIOUS ORGANIZATION CHART AND STATEMENTS OF FUNCTIONS FOR THIS OFFICE ARE RESCINDED.

APPROVED

[Redacted Signature]

REAR ADMIRAL, USN
DIRECTOR OF CENTRAL INTELLIGENCE

25X

SECRET

ORGANIZATION OF OSI

FEB. 9, 1950

(SEE ORIG.)

SECRET
SECURITY INFORMATION

ORGANIZATION OF OSI NOVEMBER 1, 1950

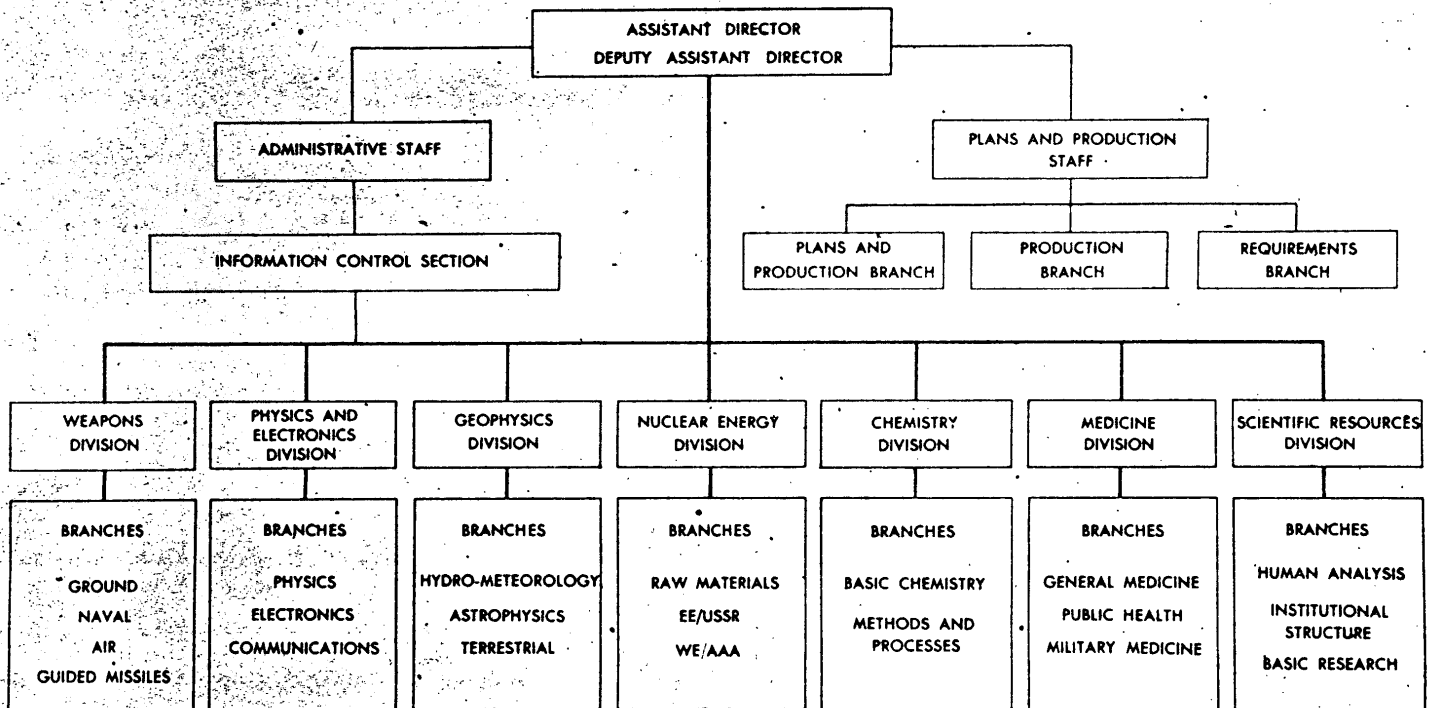

SECRET

OFFICE OF SCIENTIFIC INTELLIGENCE

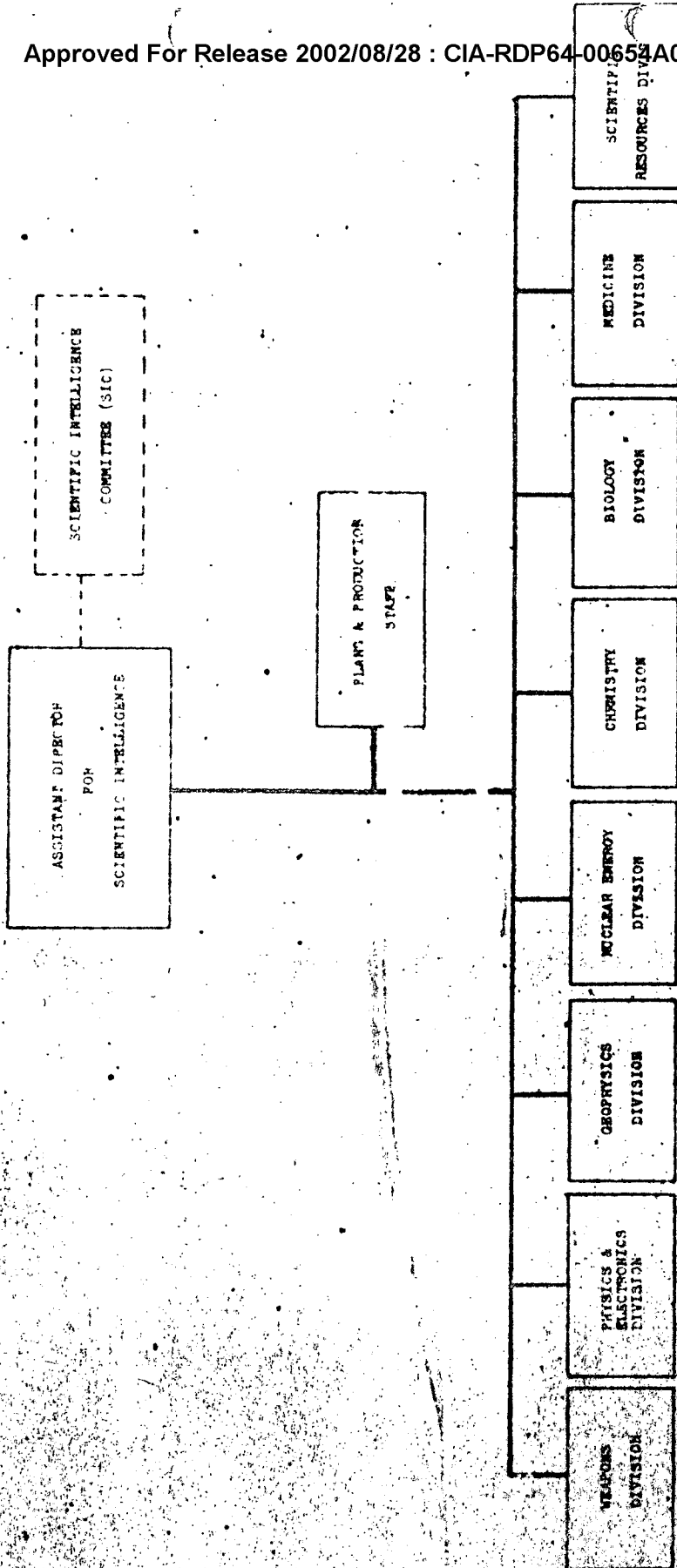

SECRET

Dec 1, 1950

SECRET

Page 9

OFFICE OF SCIENTIFIC INTELLIGENCE

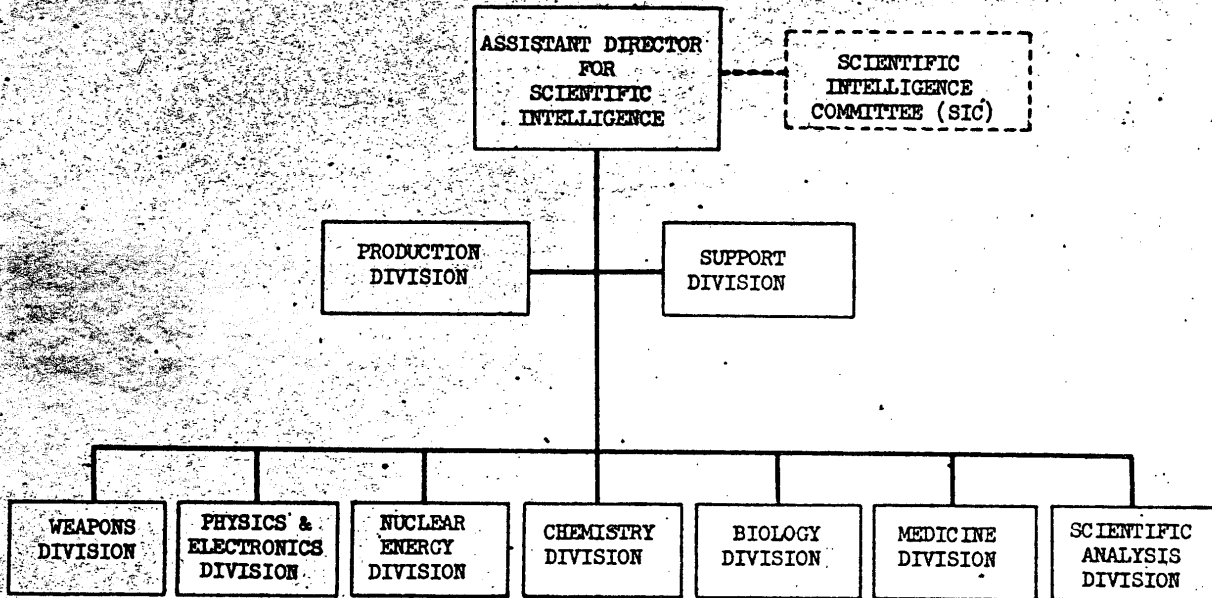

5X1



SECRET

19 January 1951

SECRET
Security Information

R 1-130
(Figure 6)
20 March 1953

OFFICE OF SCIENTIFIC INTELLIGENCE

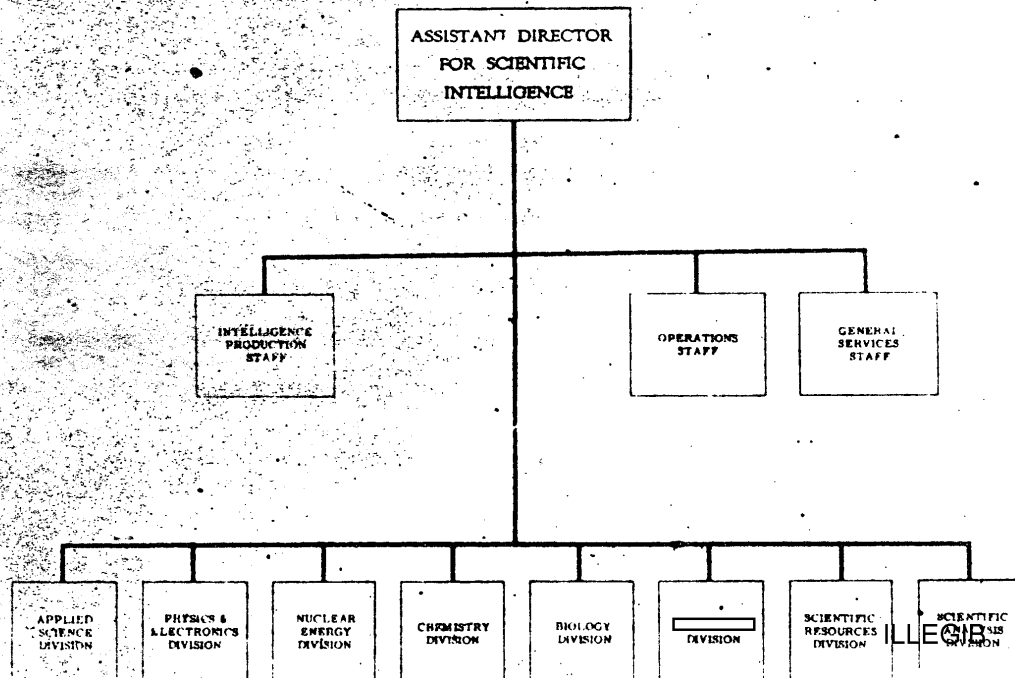

SECRET

ILLEGIB

Approved For Release 2002/08/28 : CIA-RDP64-00654A000200070001-3

Approved For Release 2002/08/28 : CIA-RDP64-00654A000200070001-3

Approved For Release 2002/08/28 : CIA-RDP64-00654A000200070001-3

Approved For Release 2002/08/28 : CIA-RDP64-00654A000200070001-3

TWO ORGANIZATIONAL CHARTS

1. OFFICE OF COLLECTION

2. OFFICE OF DISSEMINATION

BOTH DATED: 22 AUGUST 1946

(SEE ORIG. MANUSCRIPT)

SECRET

OFFICE OF COLLECTION & DISSEMINATION

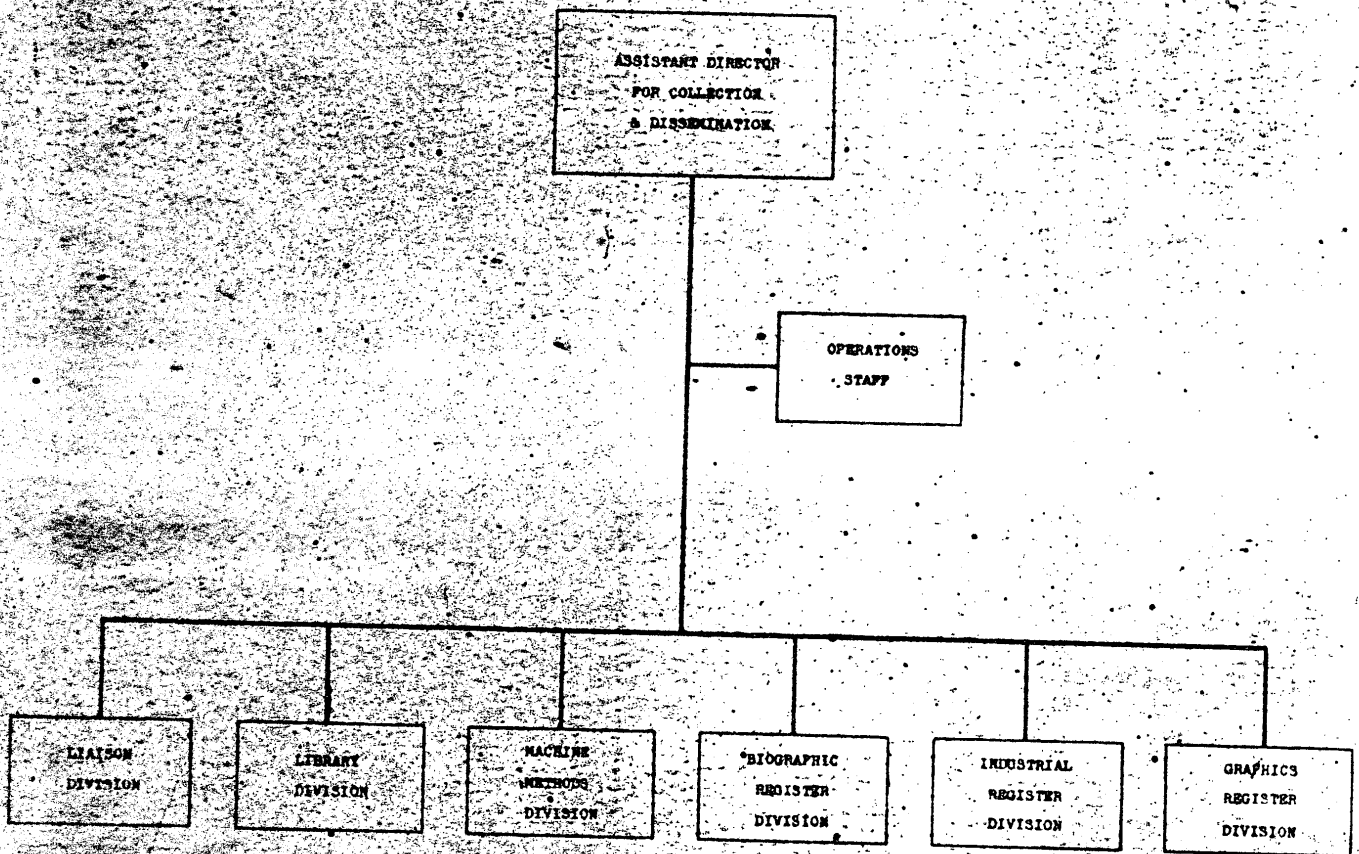

Dec. 1, 1950

ILLEGIB

Approved For Release 2002/08/28 : CIA-RDP64-00654A000200070001-3

Approved For Release 2002/08/28 : CIA-RDP64-00654A000200070001-3

SECRET

Page 12

OFFICE OF COLLECTION AND DISSEMINATION

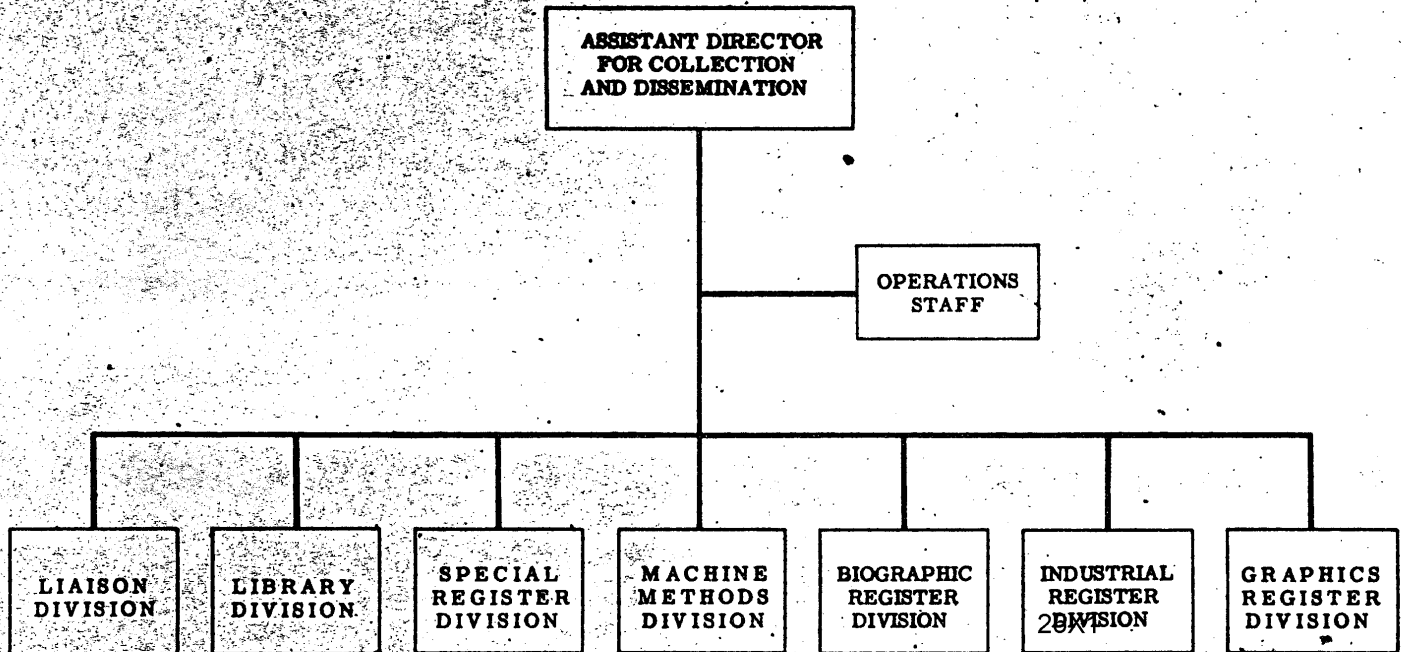

27 May 1951
Reissues: Page 12
Dated : 19 January 1951

SECRET

5X1

SECRET

OFFICE OF COLLECTION AND DISSEMINATION

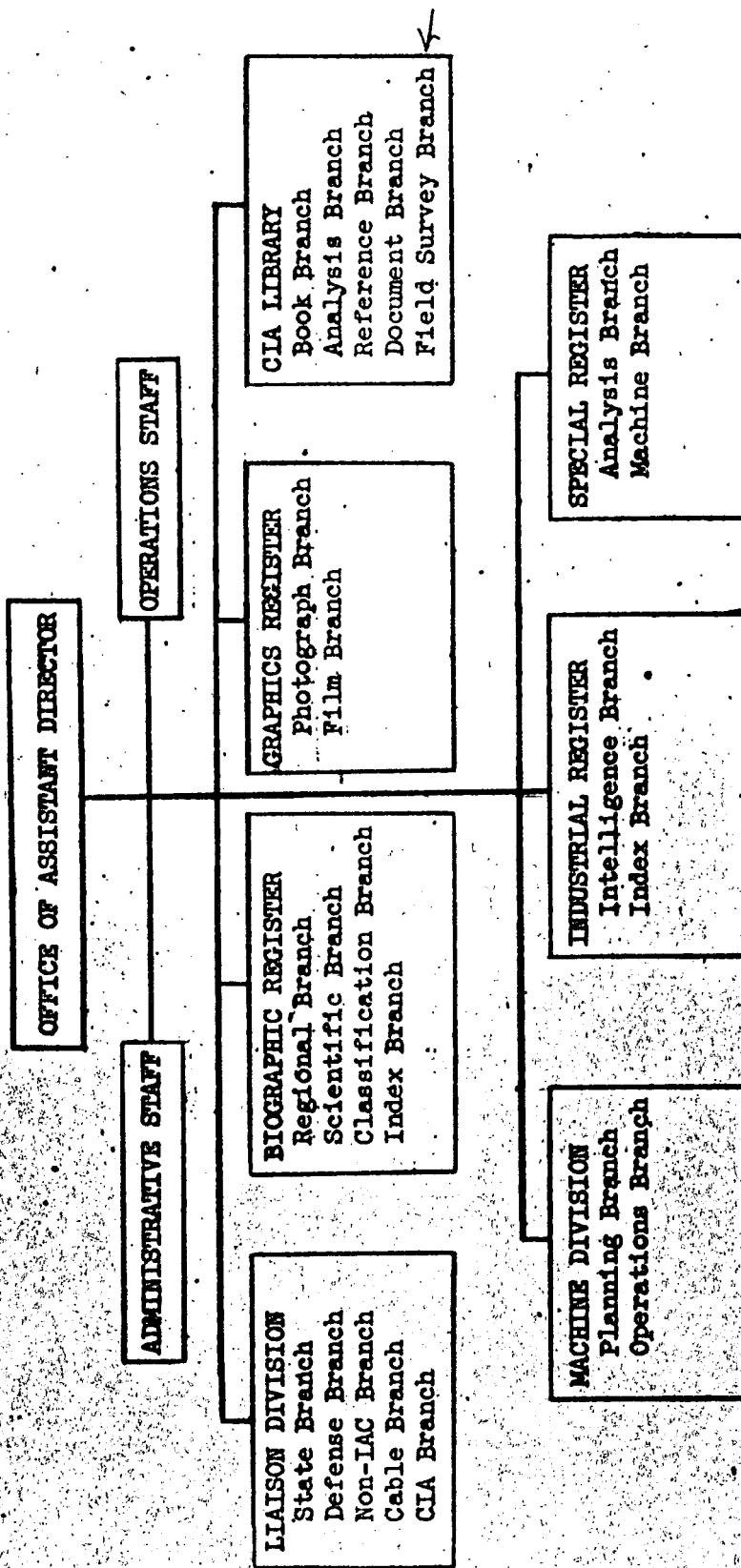

1951

SECRET

R 1-17
Figure 2
20 March 1953

SECRET
Security Information

OFFICE OF COLLECTION AND DISSEMINATION

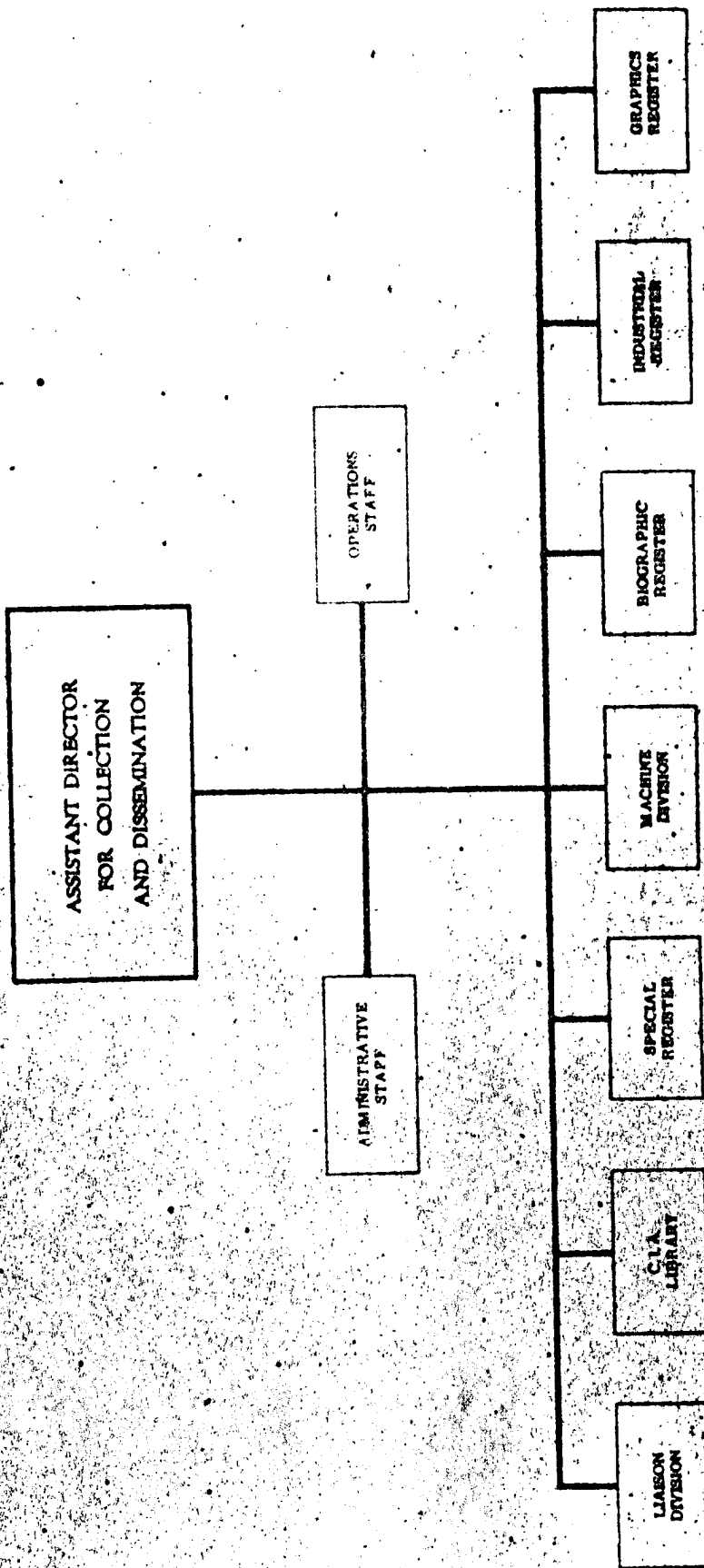

SECRET

Approved Release 2002/08/28 : CIA-RDP64-00654A000200070001-3

Approved For Release 2002/08/28 : CIA-RDP64-00654A000200070001-3

SECRET

OFFICE OF OPERATIONS

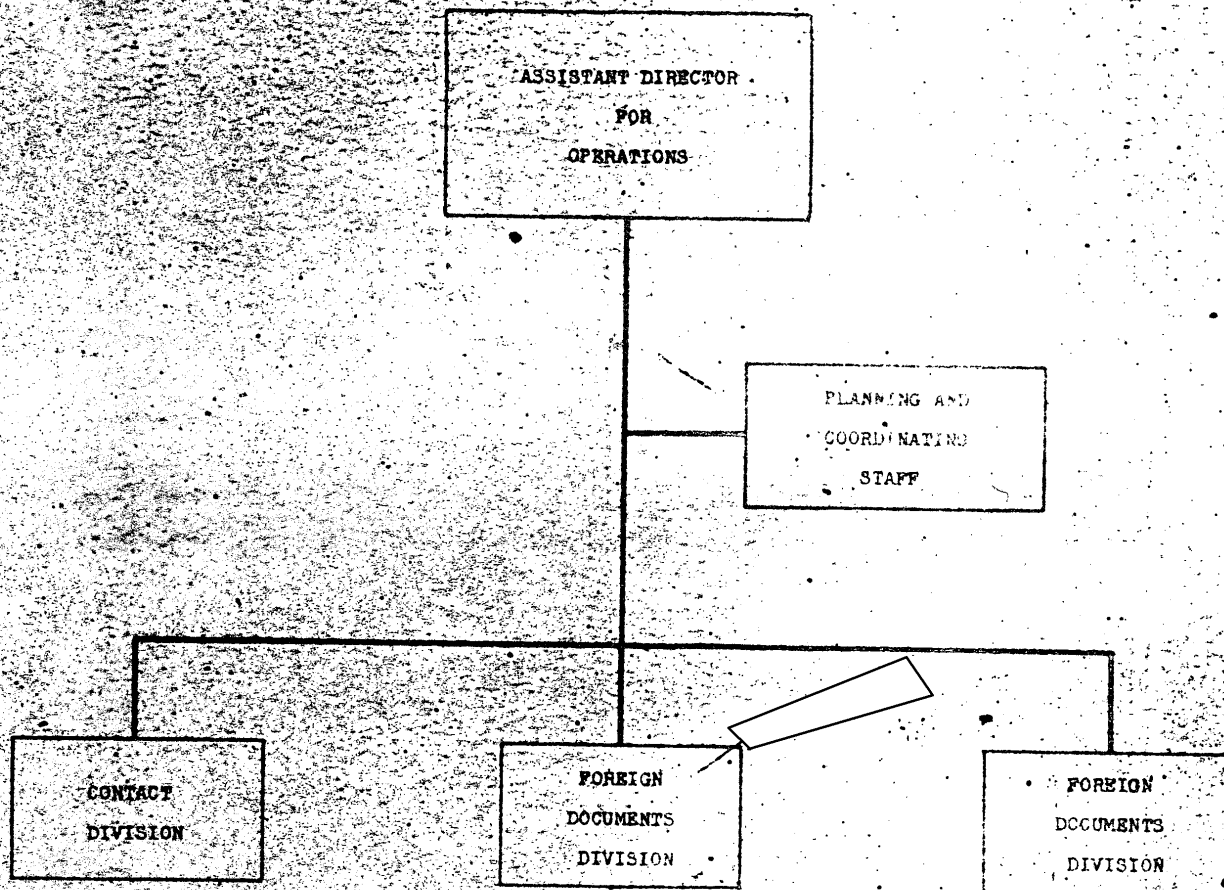

Dec 1, 1950 32

STAT

SECRET

OFFICE OF OPERATIONS

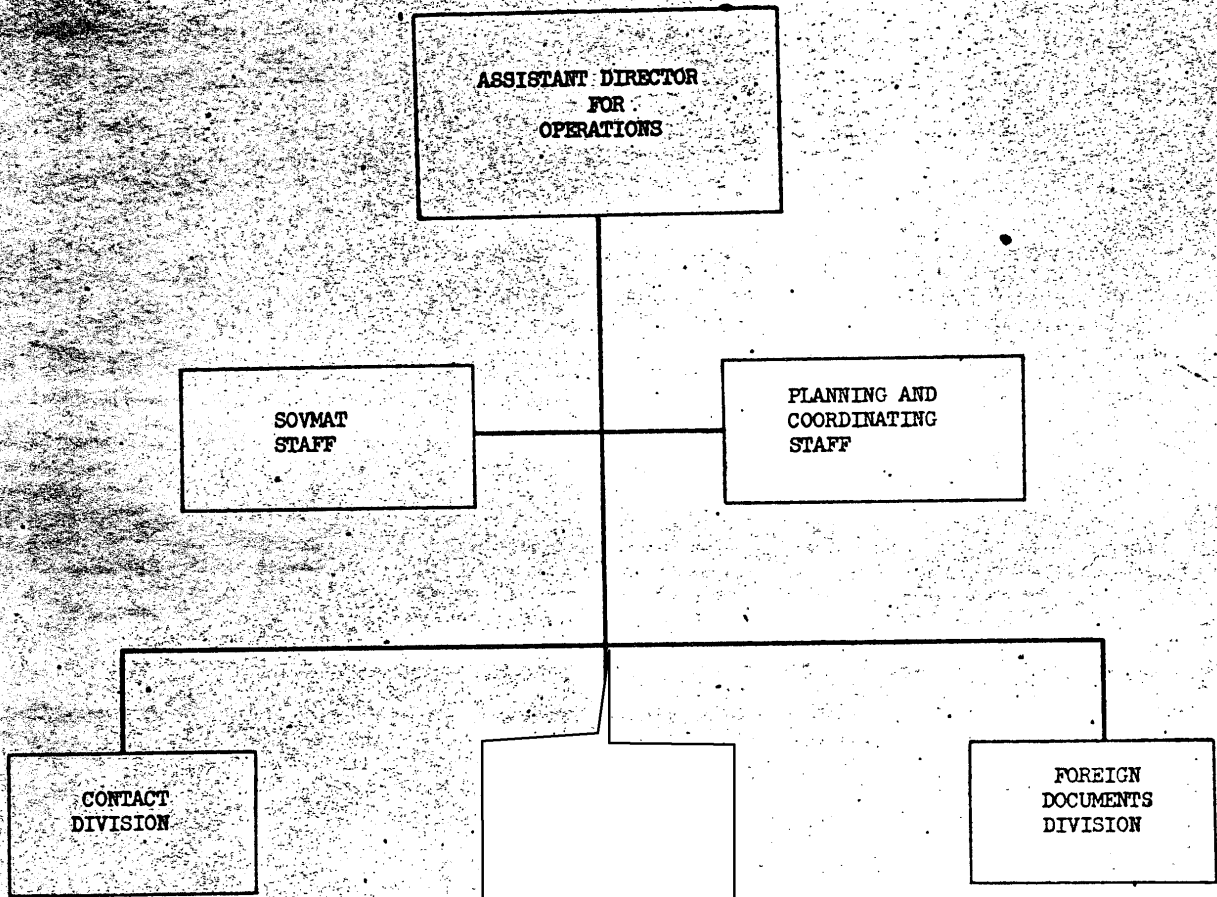

STAT

SECRET

SECRET
Security Information

R 1 100
Figure 7
20 March 1955

OFFICE OF OPERATIONS

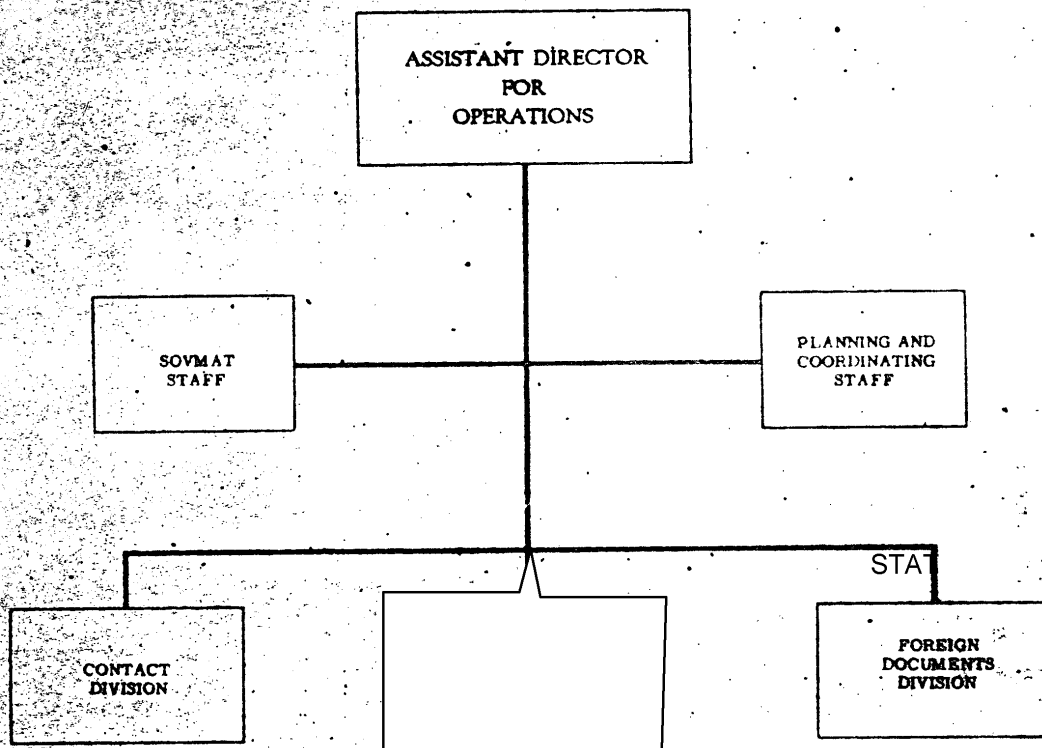

SECRET

Approved For Release 2002/08/28 : CIA-RDP64-00654A000200070001-3

Approved For Release 2002/08/28 : CIA-RDP64-00654A000200070001-3

OFFICE OF INTELLIGENCE COORDINATION

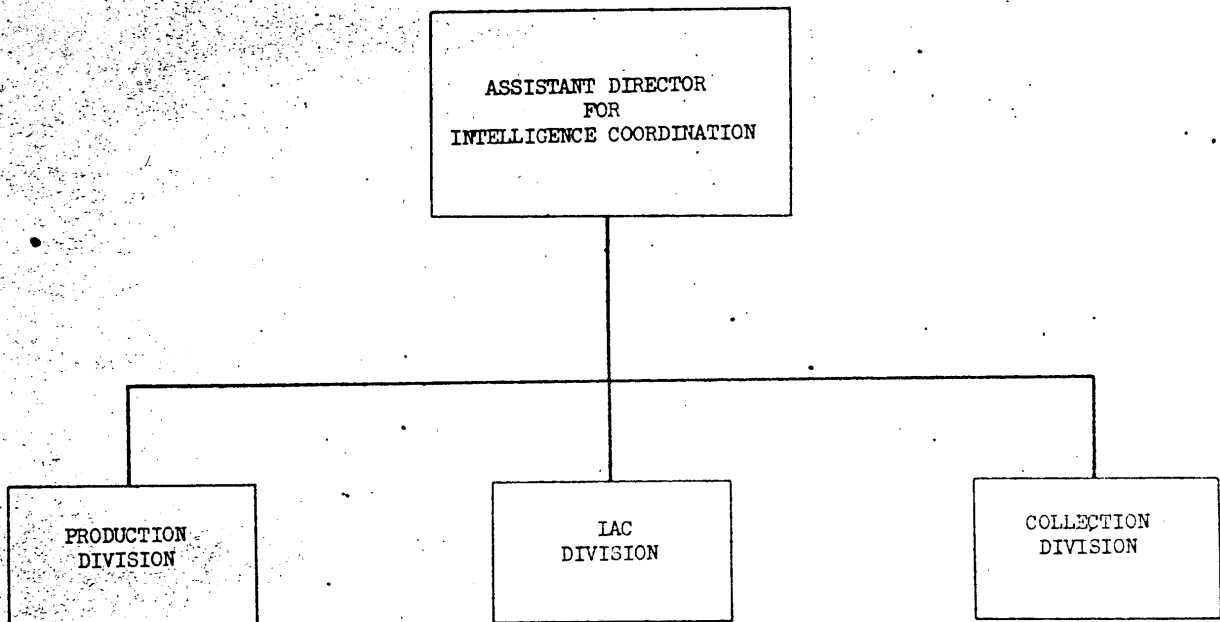

PRODUCTION
DIVISION

IAC
DIVISION

COLLECTION
DIVISION

CIA EXECUTIVE

13 NOV. 1950

(SEE ORIG. MANUSCRIPT)

SECRET

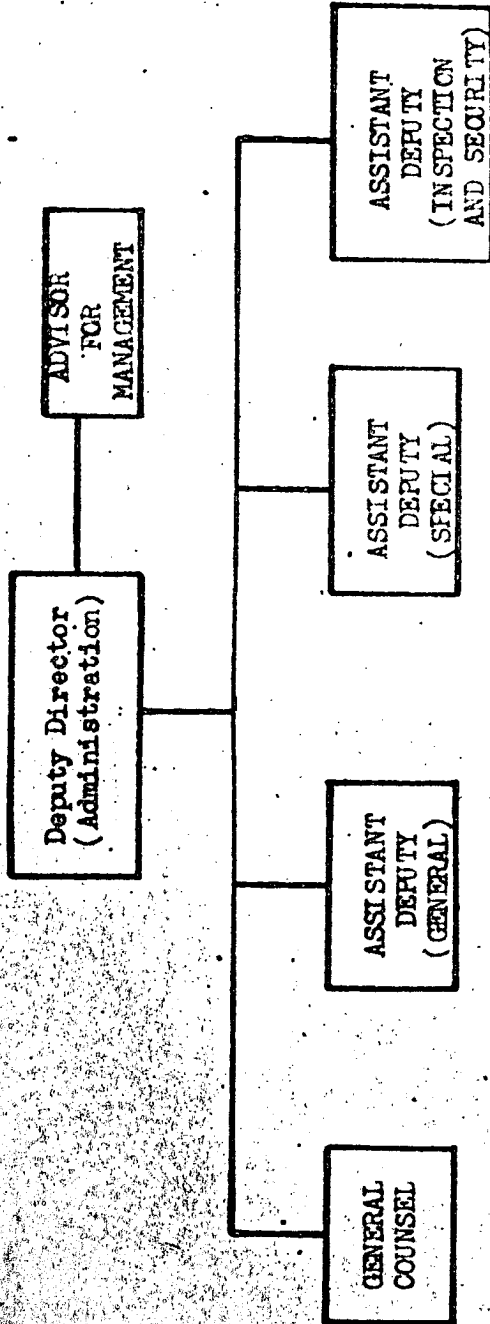

SECRET

SECRET

DEPUTY DIRECTOR (ADMINISTRATION)

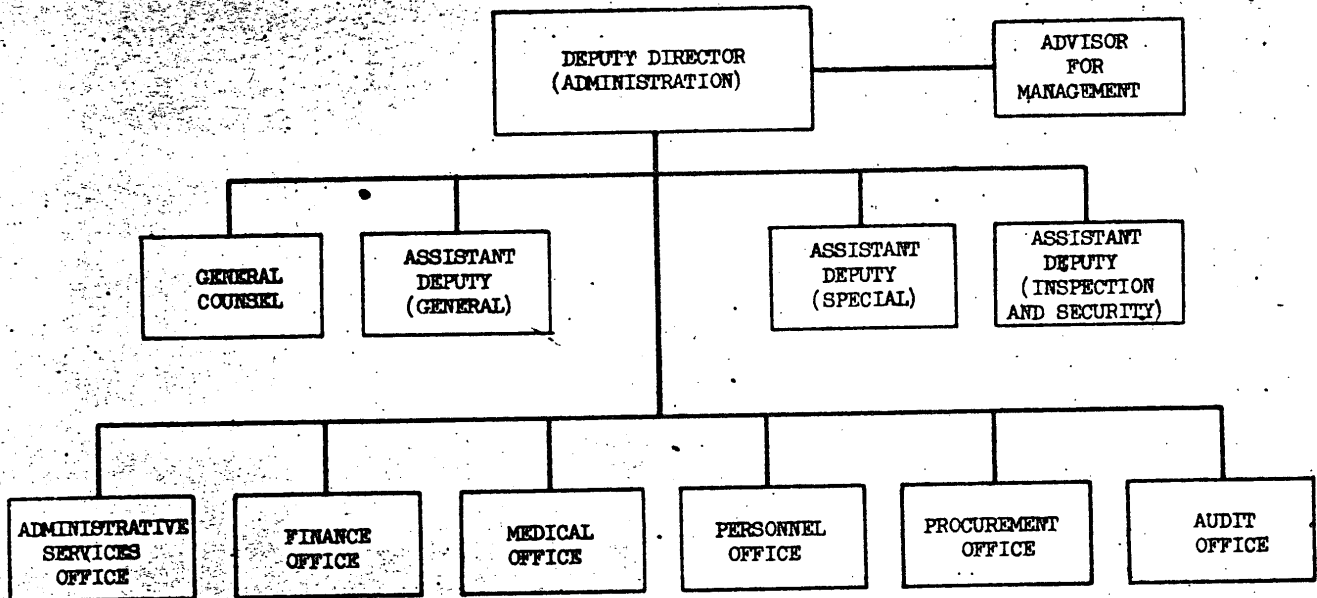

[Redacted] 25X1

Director of Central Intelligence 18 April 1951

Rescinds: Page 25

Dated: 19 January 1951

SECRET

25X1

[Redacted]

OFFICE OF THE
DEPUTY DIRECTOR (ADMINISTRATION)

20 MARCH 1953

(SEE ORIG. MANUSCRIPT)

SECRET

ADMINISTRATION OFFICE

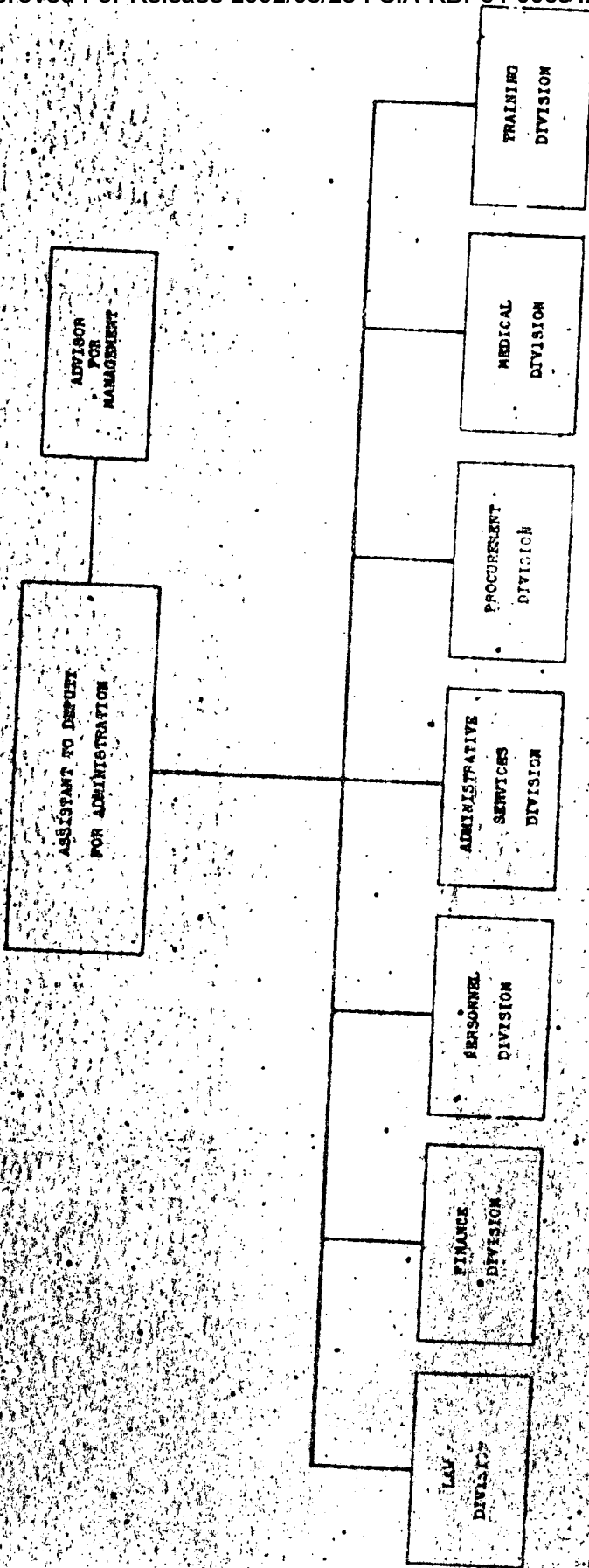

Dec 1, 1950 30

INSPECTION & SECURITY

1950

(SEE ORIG. MANUSCRIPT)

SECURITY OFFICE

ASSISTANT TO DEPUTY
FOR SECURITY

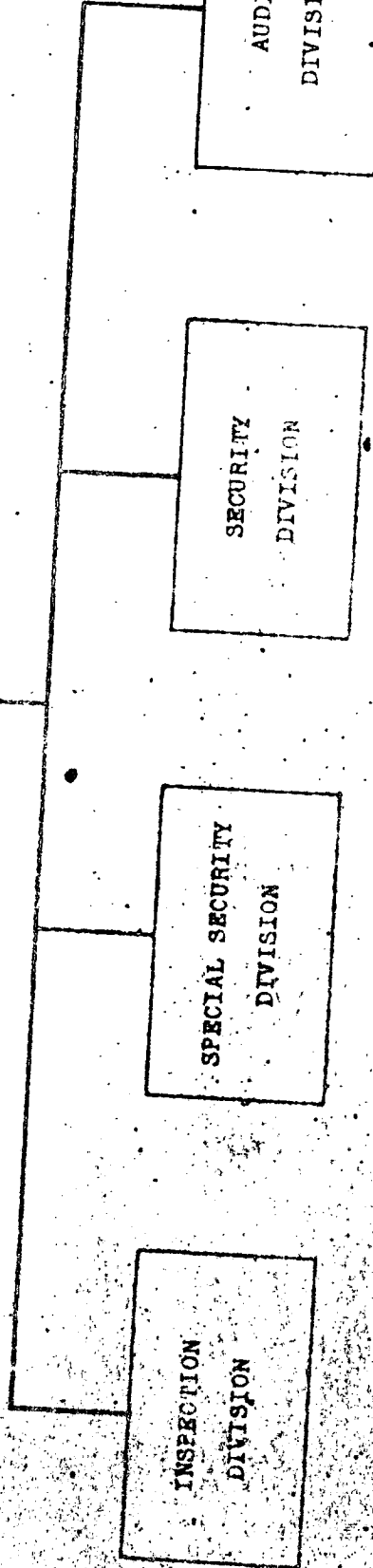

SECRET

Dec 1, 1950

ASSISTANT DEPUTY
(INSPECTION & SECURITY)

19 JAN 1951

(SEE ORIG. MANUSCRIPT)

SECRET

ASSISTANT DEPUTY (INSPECTION AND SECURITY)

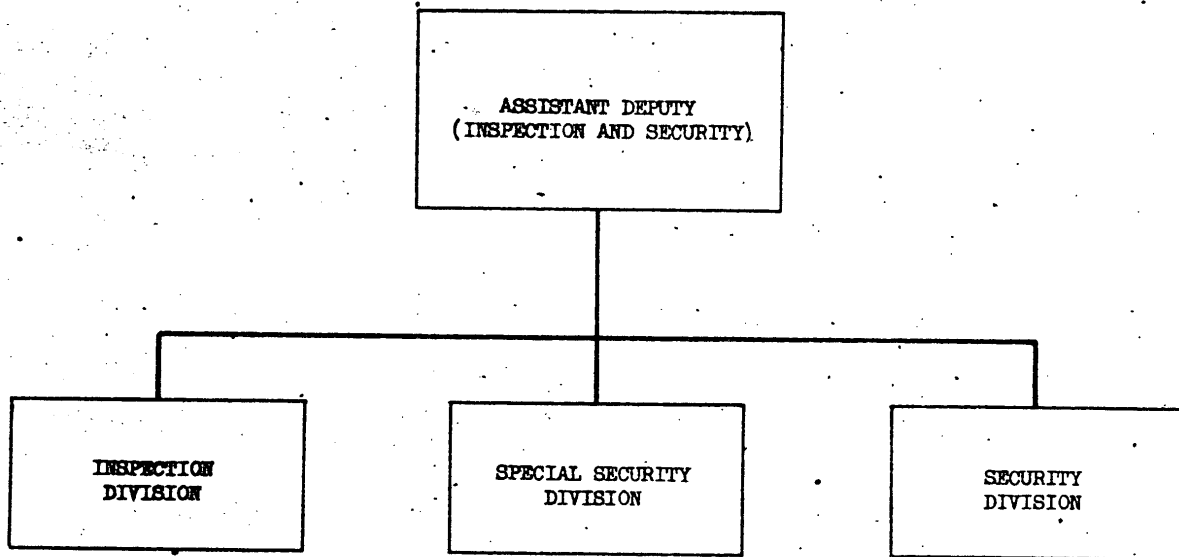

[Redacted]

25X1

Director of Central Intelligence

18 April 1951

Revisits: Page 28

Dated: 19 January 1951

SECRET

25X1

[Redacted]

ASSISTANT DEPUTY

(INSPECTION & SECURITY)

1951

(SEE ORIG. MANUSCRIPT)

TWO ORGANIZATIONAL CHARTS

1. SECURITY OFFICER CIA
20 MARCH 1952

2. SECURITY OFFICE
20 MARCH 1953

(SEE ORIG. MANUSCRIPT)

SECRET

FINANCE DIVISION

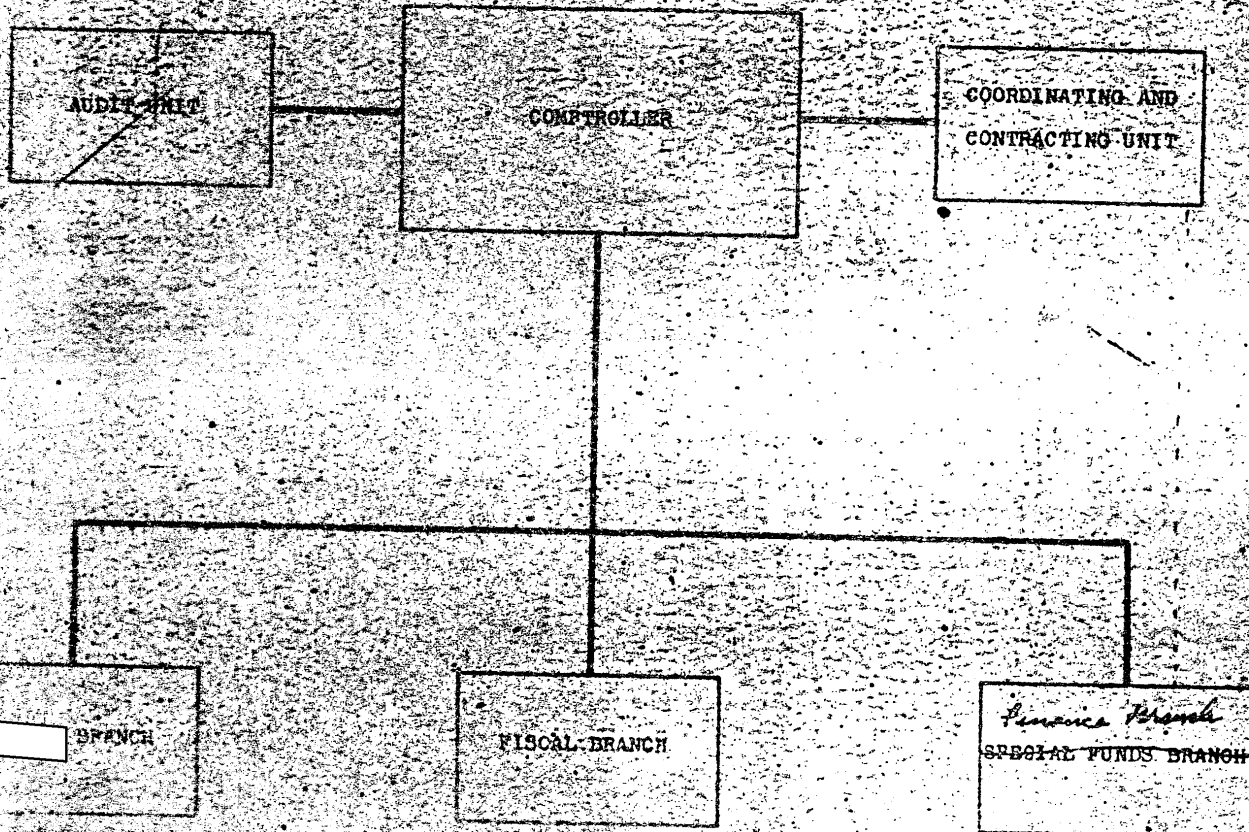

LEGIB

SECRET

FINANCE OFFICE

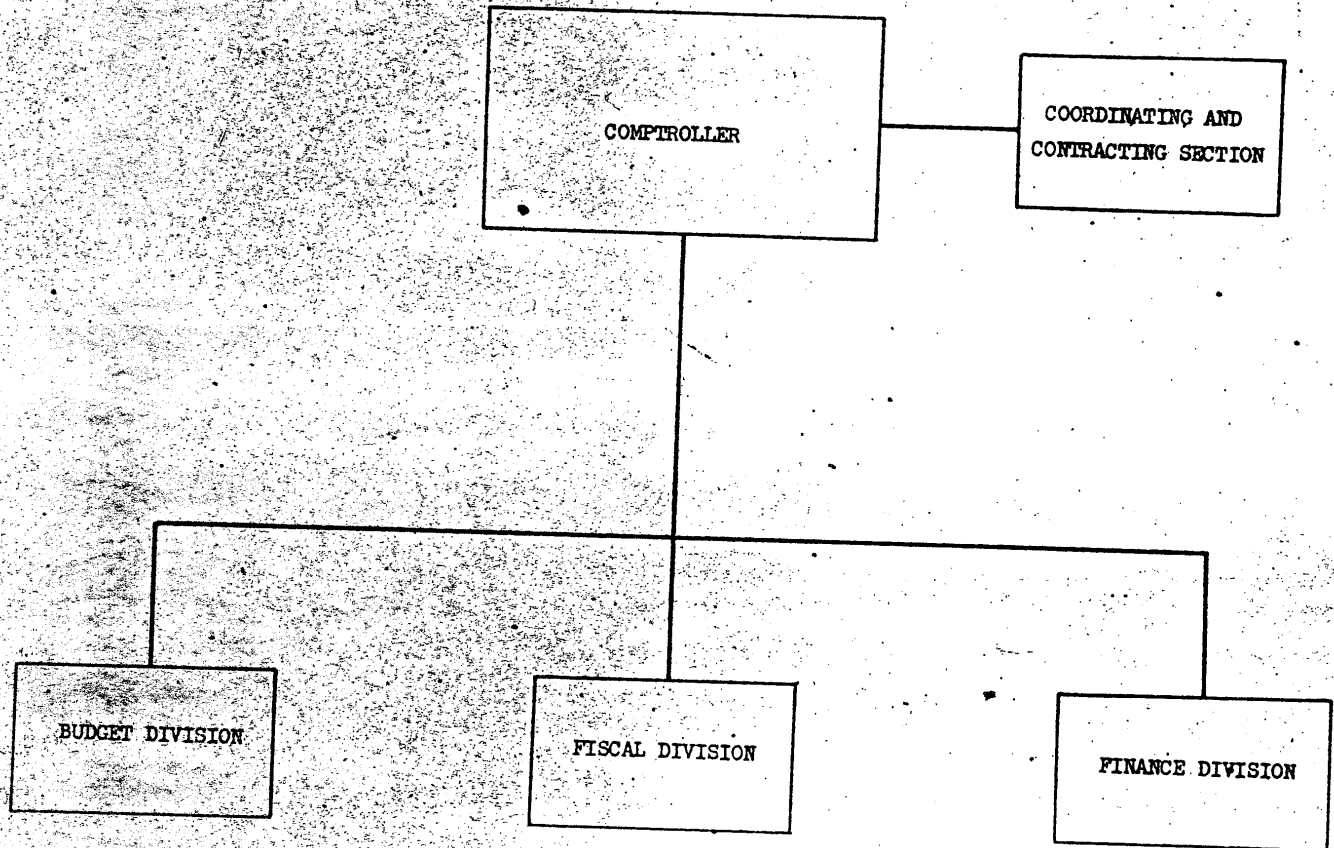

25X1

[Redacted box]

R 1-140
(Figure 4)
20 March 1952

SECRET
Security Information

COMPTROLLER

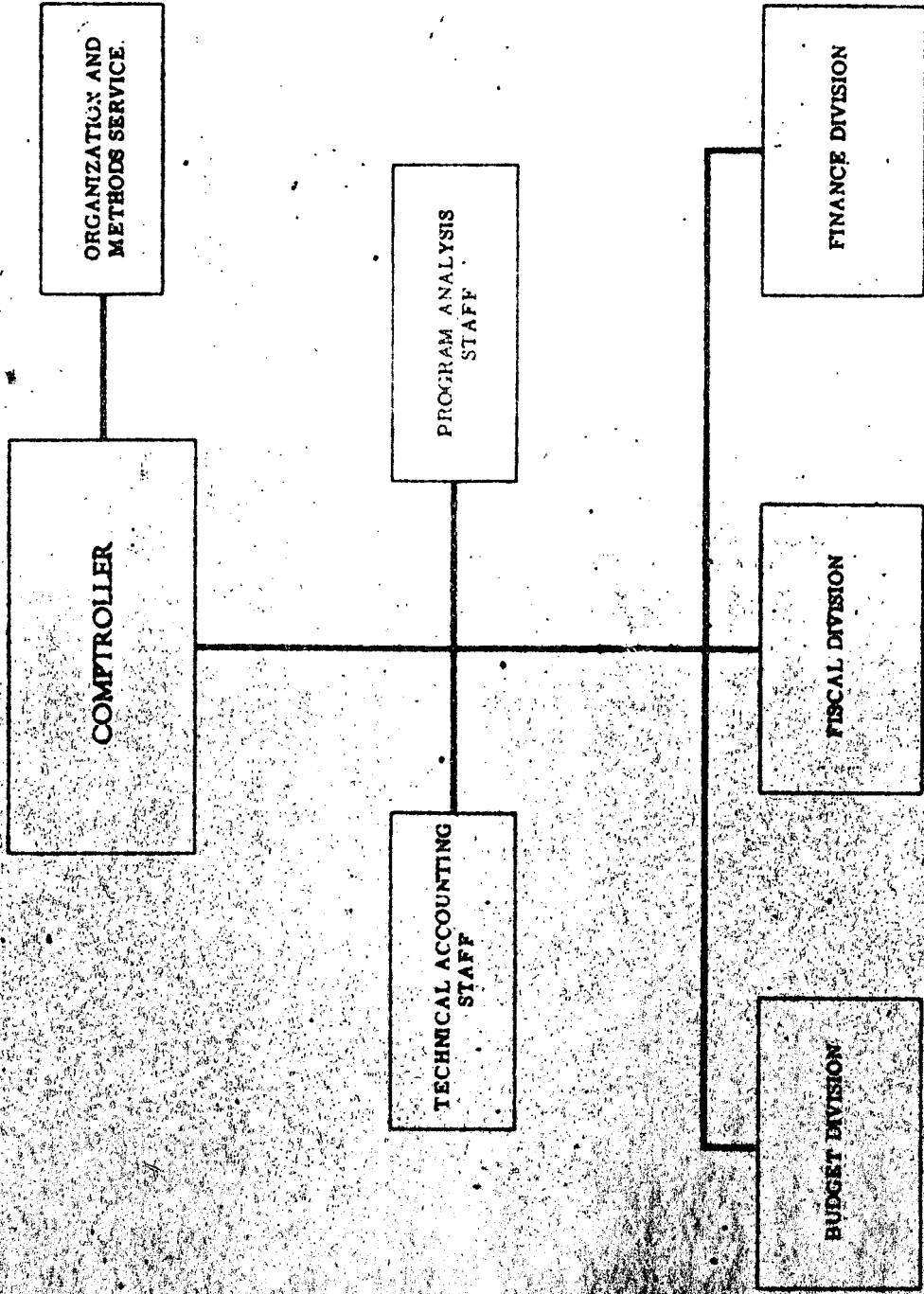

SECRET

PERSONNEL DIVISION

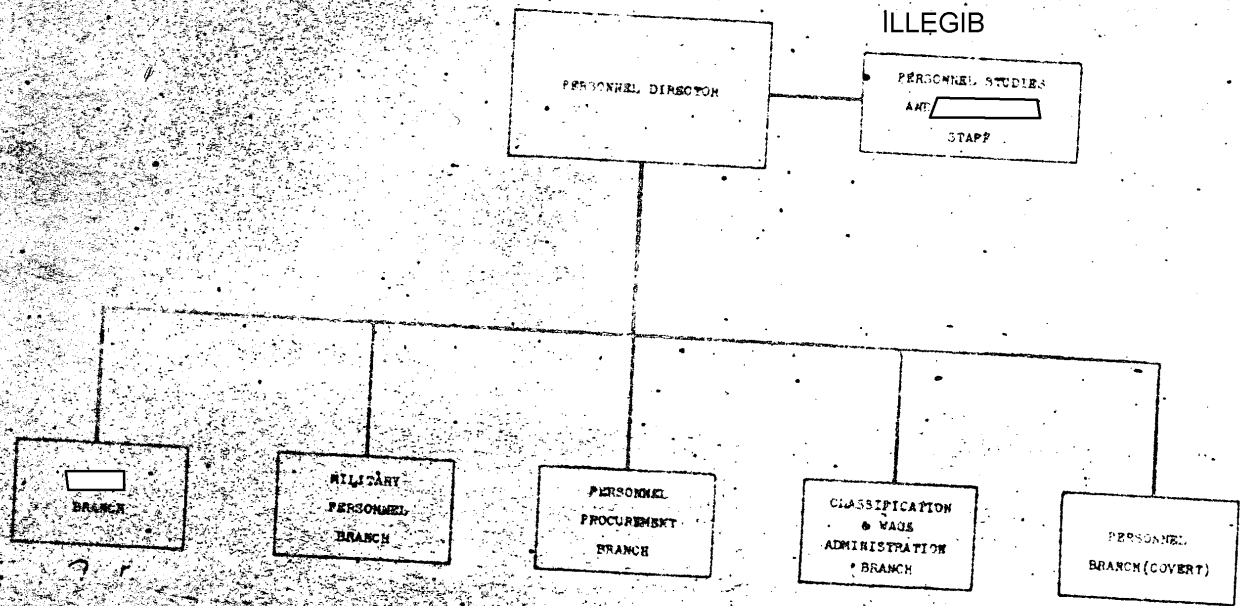

ILLEGIB

PERSONNEL DIRECTOR

PERSONNEL STUDIES
ANT
STAFF

ILLEGIB

BRANCH

MILITARY
PERSONNEL
BRANCH

PERSONNEL
PROCUREMENT
BRANCH

CLASSIFICATION
& WAGE
ADMINISTRATION
BRANCH

PERSONNEL
BRANCH (COVERT)

Dec 1, 1950

SECRET

Page 38

PERSONNEL OFFICE

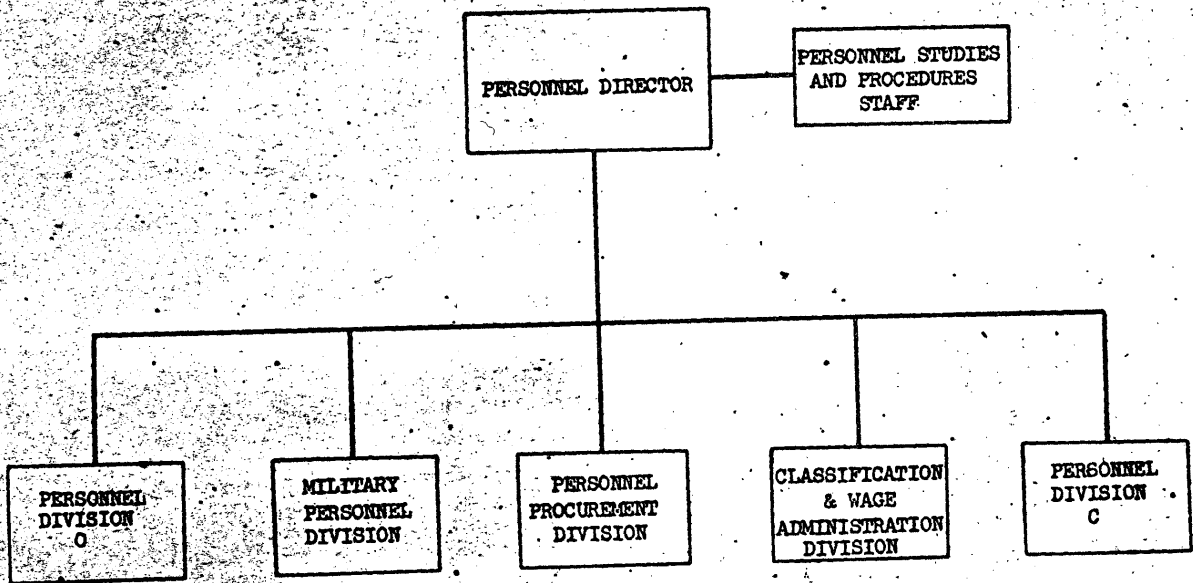

25X

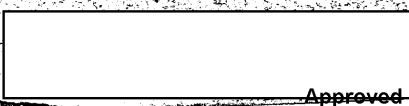

SECRET

19 January 1951

R 1-140
(Figure 2)

PERSONNEL OFFICE

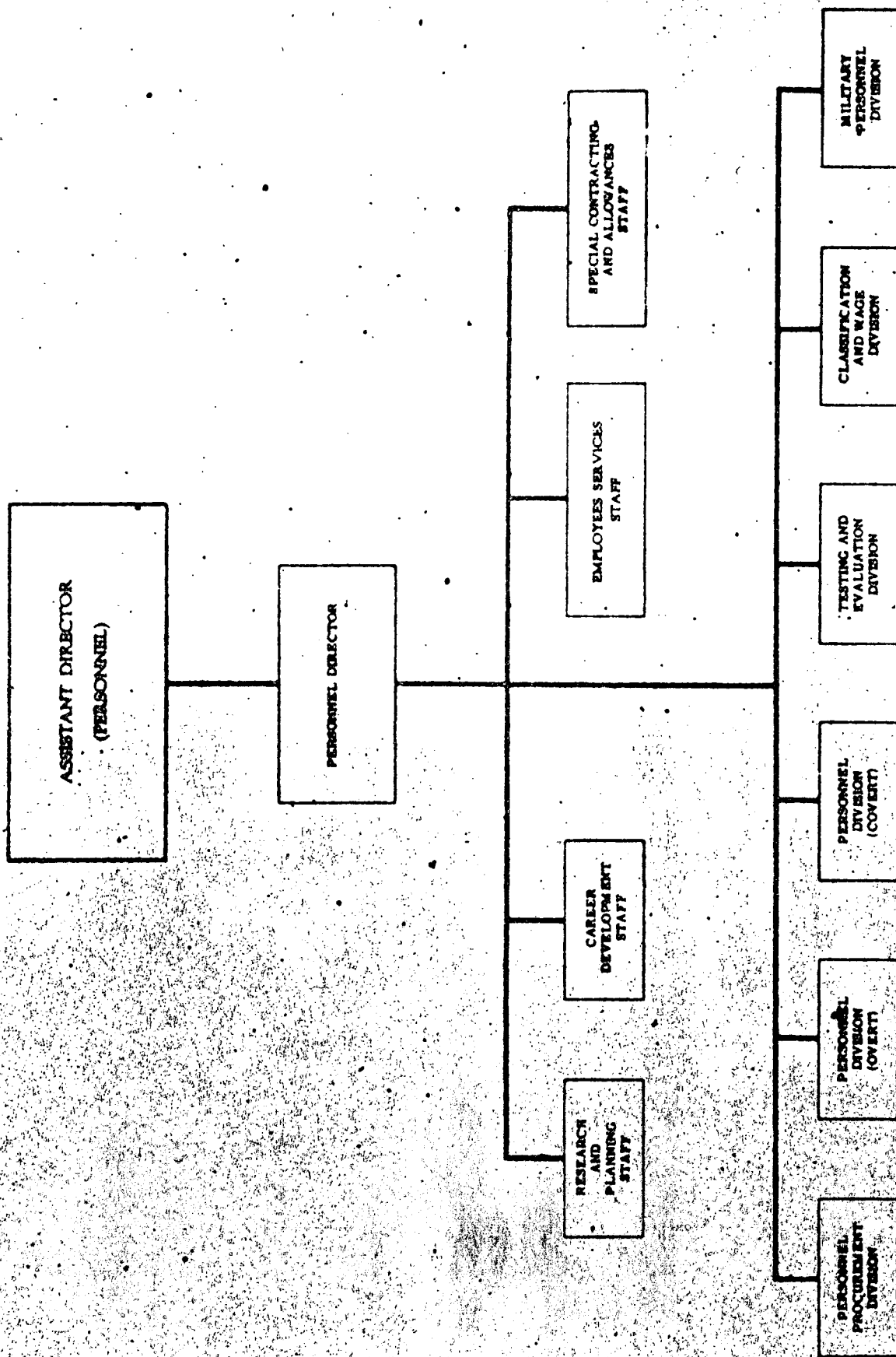

SECRET

PROCUREMENT DIVISION

CHIEF OF PROCUREMENT



REQUIREMENTS BRANCH

PROCUREMENT & CONTRACT BRANCH

SUPPLY BRANCH

SECRET

Dec 1, 1950

SECRET

PROCUREMENT OFFICE

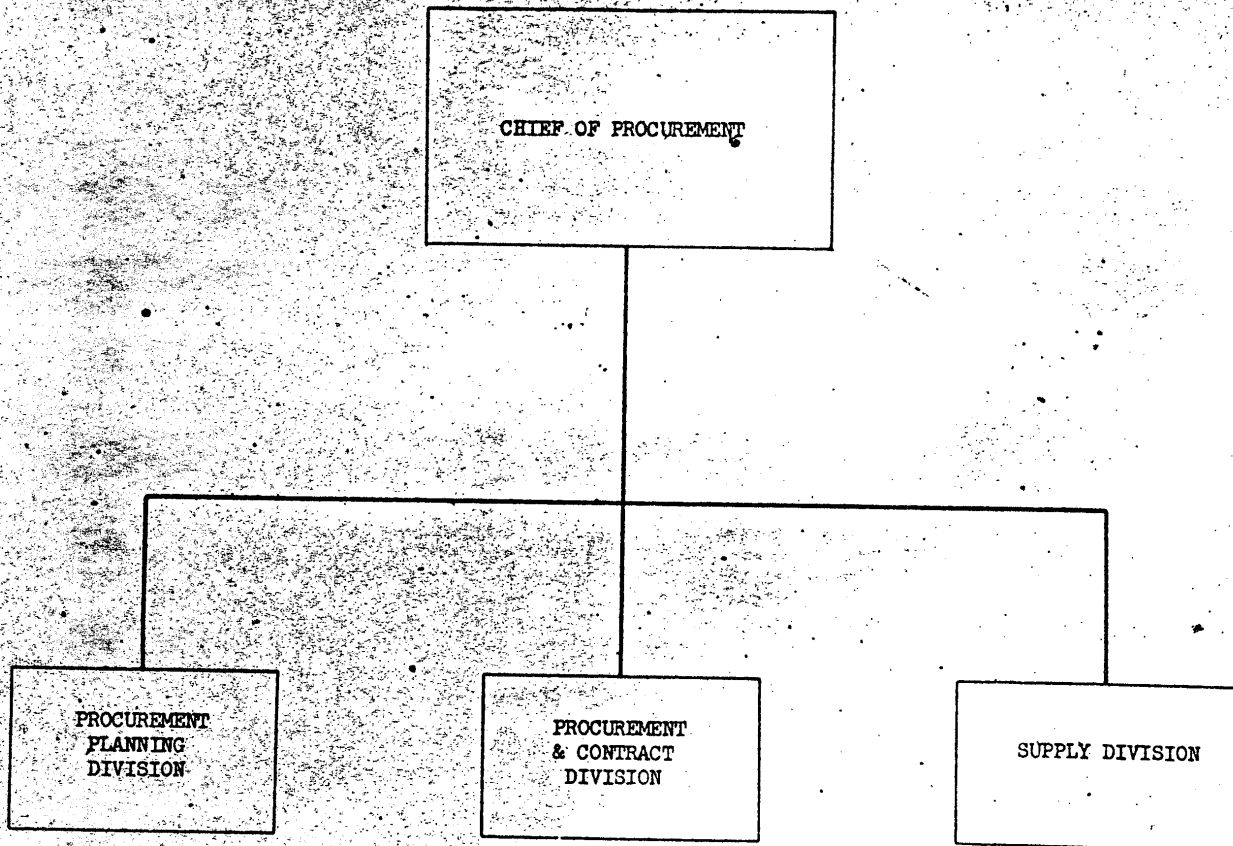

SECRET

25X1

R 1 140
(Figure 5)
20 March 1953

SECRET
Security Information
LOGISTICS OFFICE

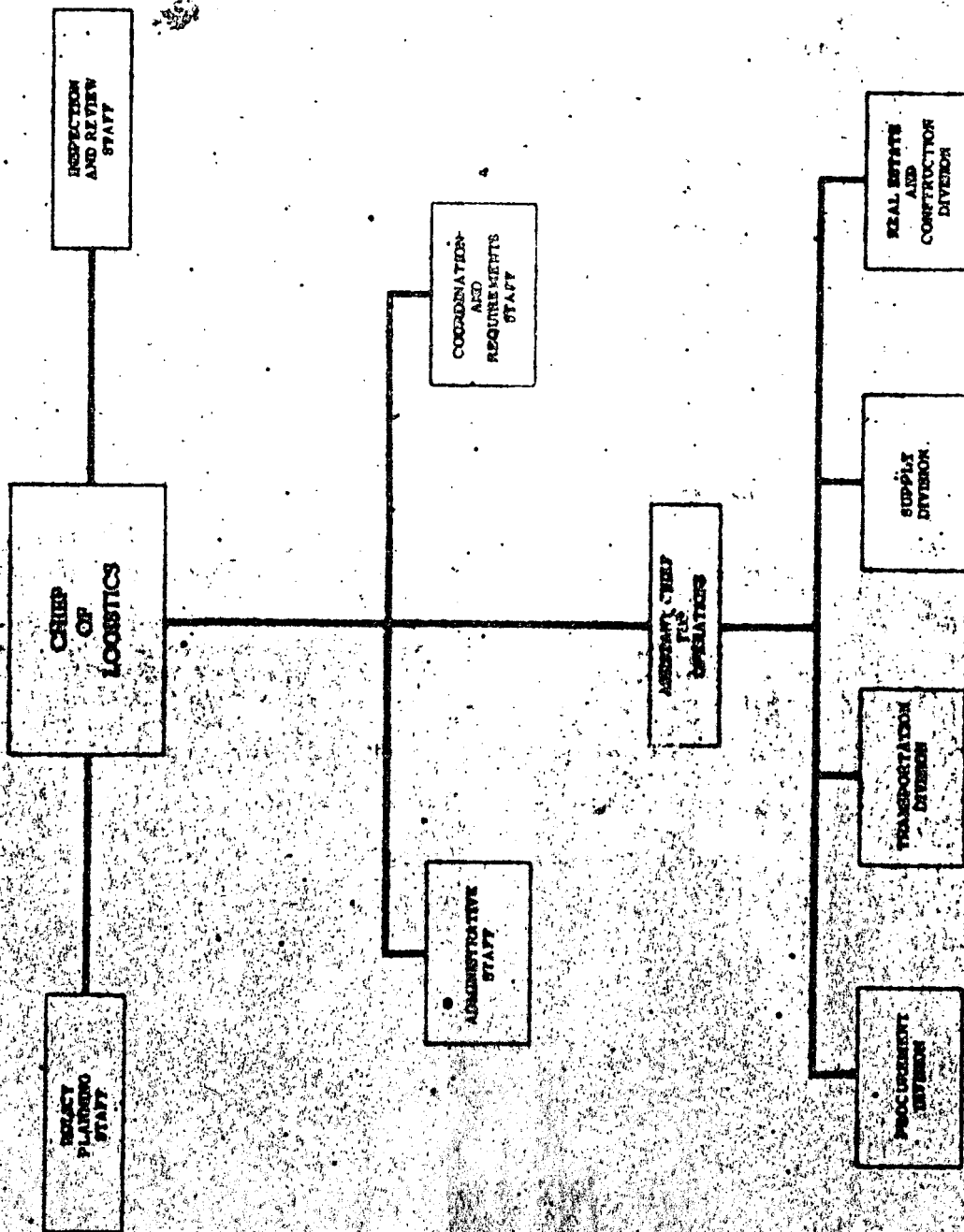

SECRET

SECRET

ADMINISTRATIVE SERVICES DIVISION

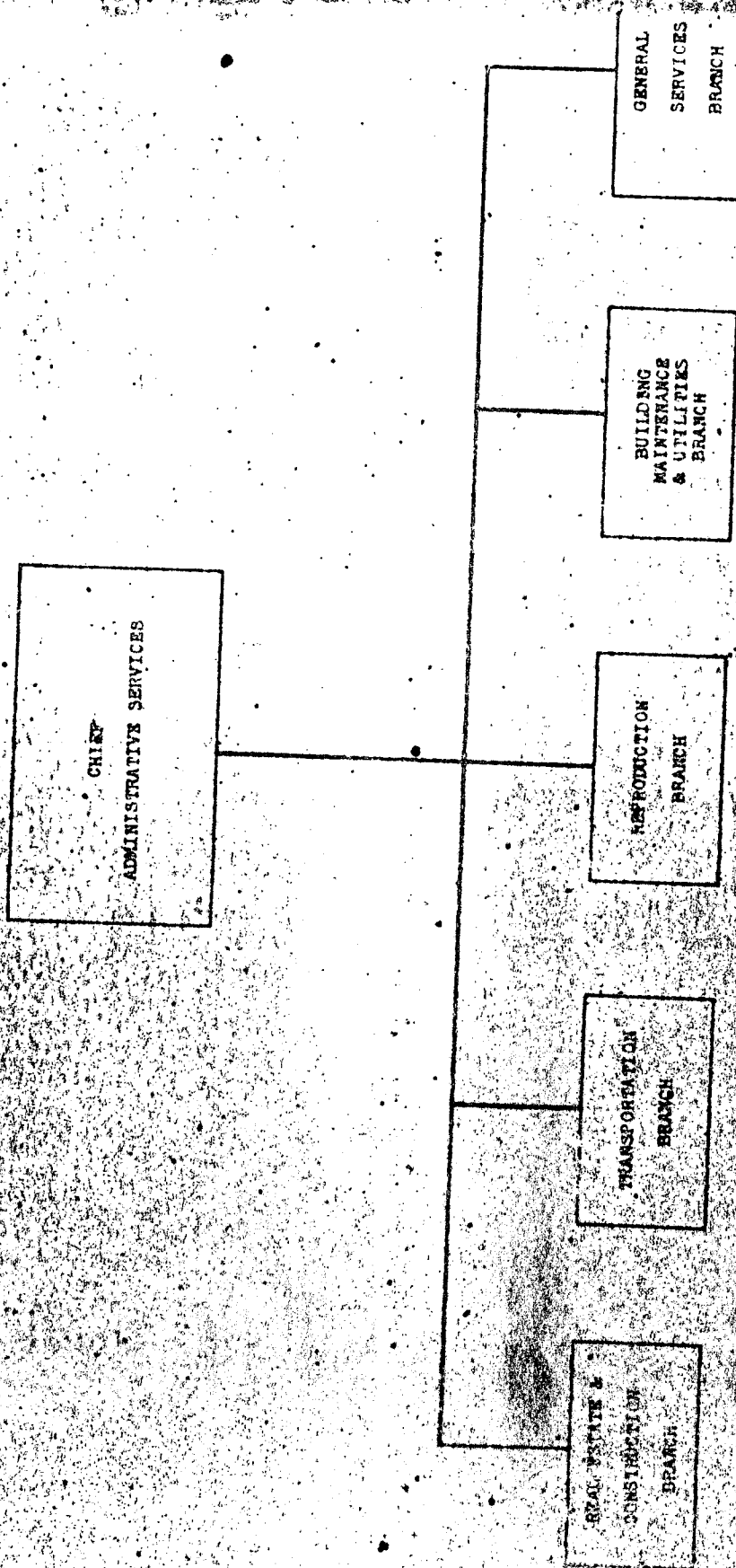

SECRET

Dec 1, 1950

SECRET

ADMINISTRATIVE SERVICES OFFICE

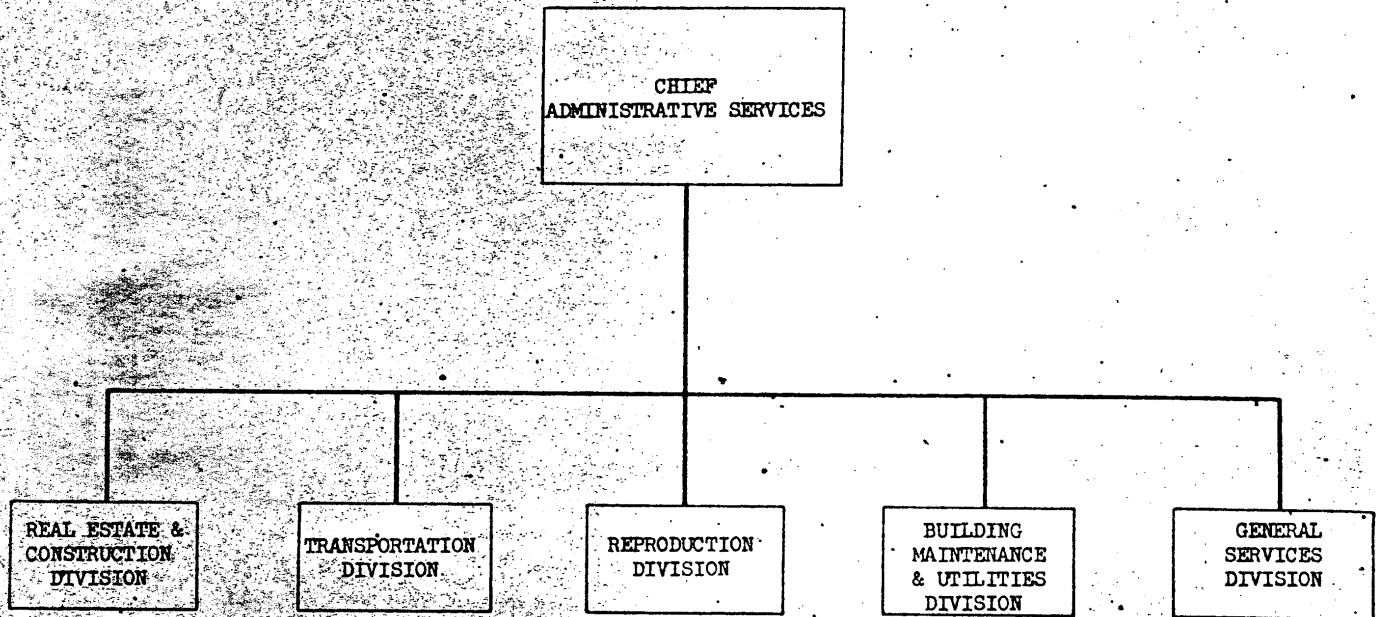

25X1



SECRET

19 January 1951

R 1 146
(Figure 1)
20 March 55

SECRET
Security Information

GENERAL SERVICES OFFICE

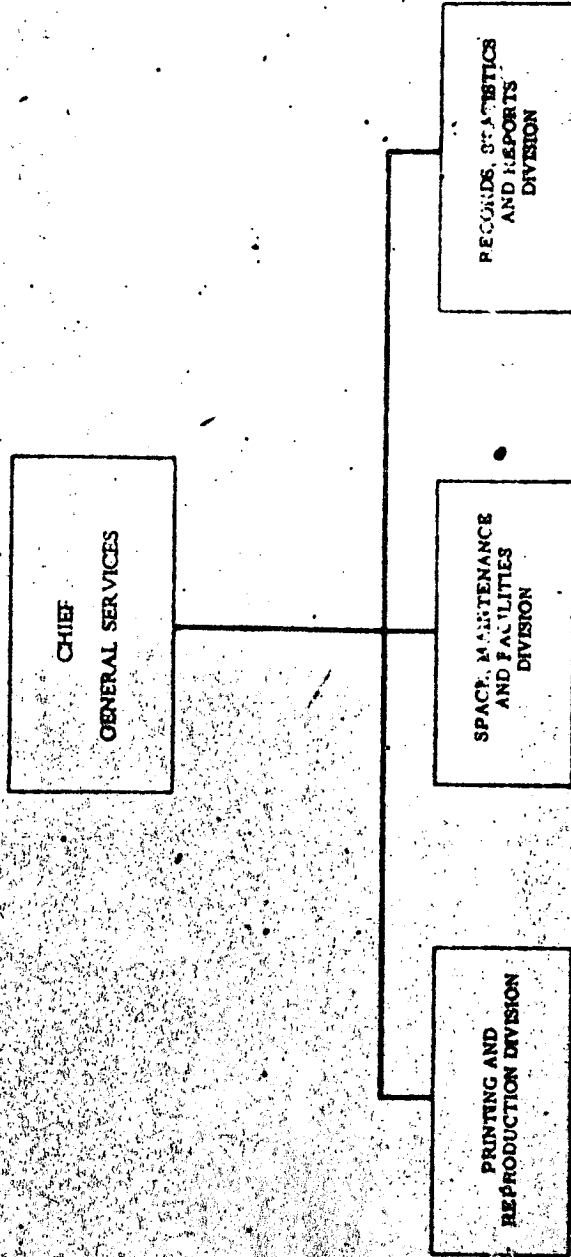

SECRET

TABLE OF ORGANIZATION

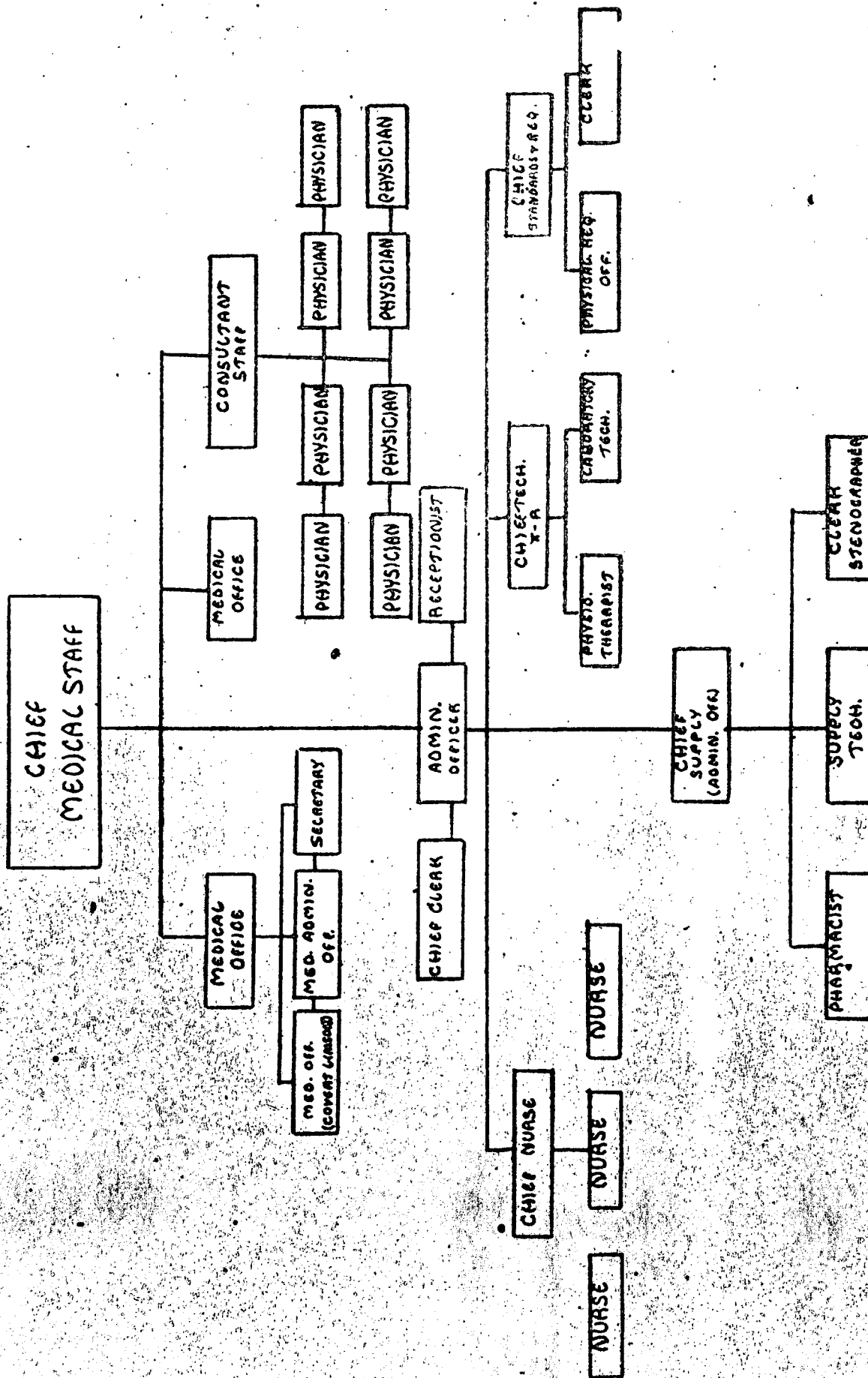

APPROVED SEPTEMBER 21, 1950

SECRET
MEDICAL DIVISION

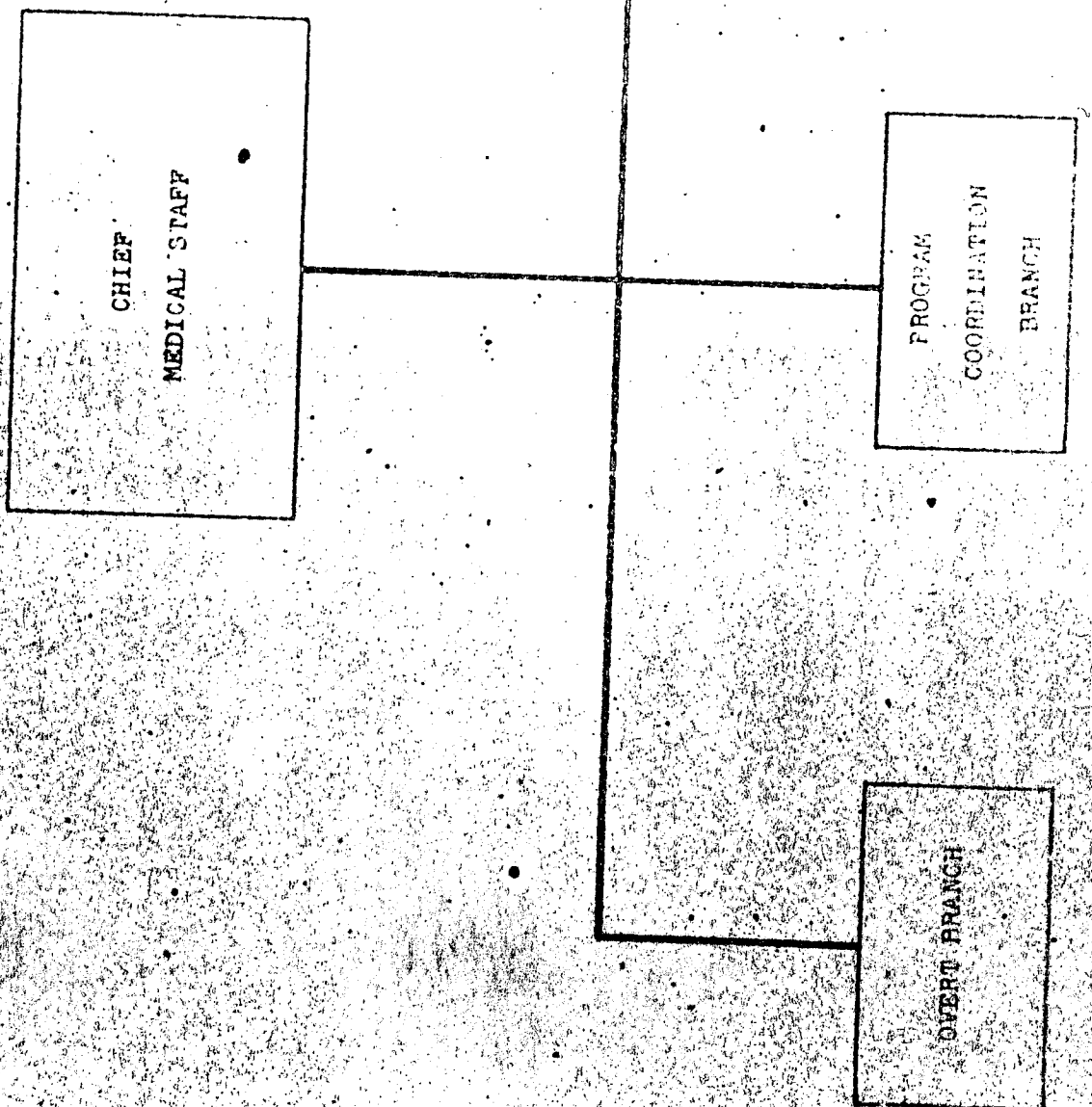

Dec 1, 1958

SECRET

SECRET

MEDICAL OFFICE

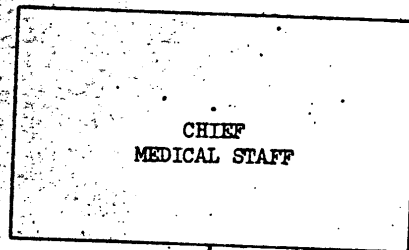

TECHNICAL SERVICES
DIVISION

PROGRAM
COORDINATION
DIVISION

SPECIAL SUPPORT
DIVISION



SECRET

5X1

SECRET

Security Information

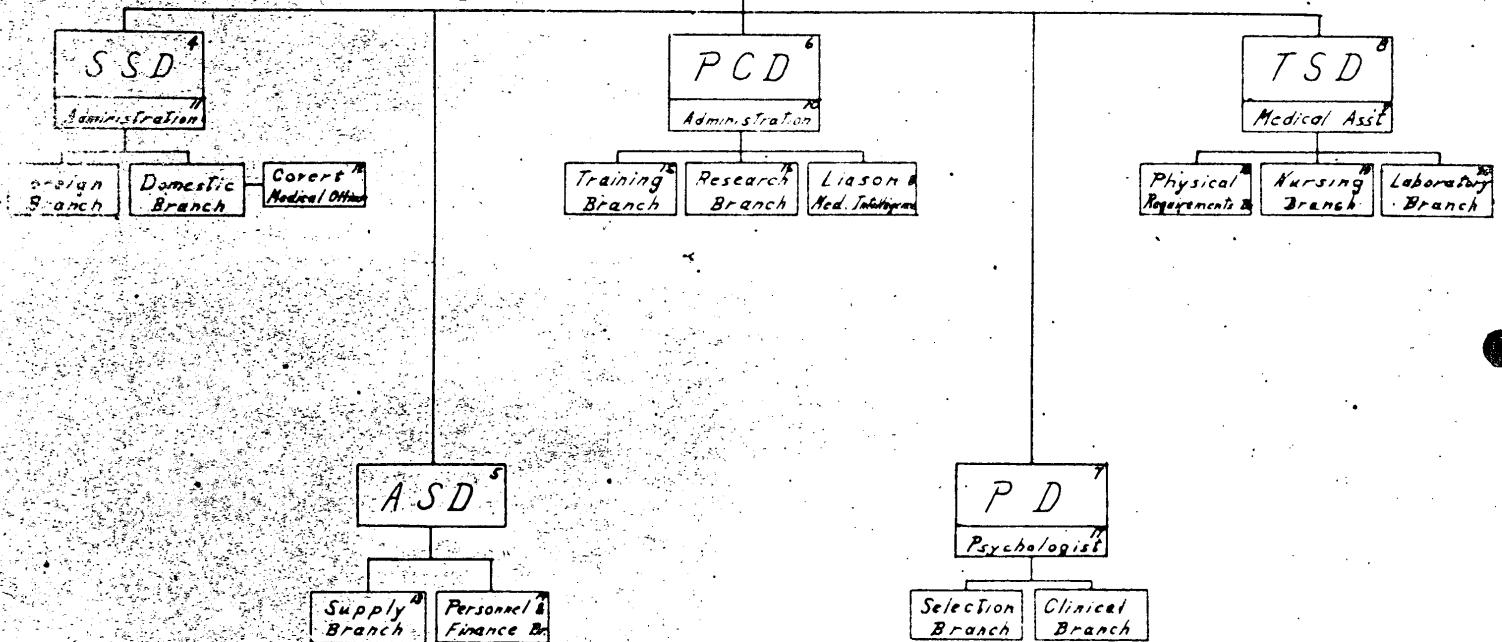
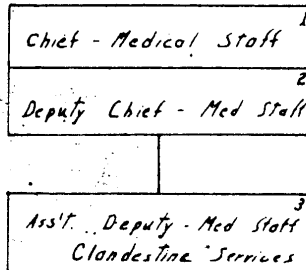

MEDICAL OFFICE

20 MARCH 1953

(SEE ORIG. MANUSCRIPT)

SECRET

Page 3B

TRAINING OFFICE

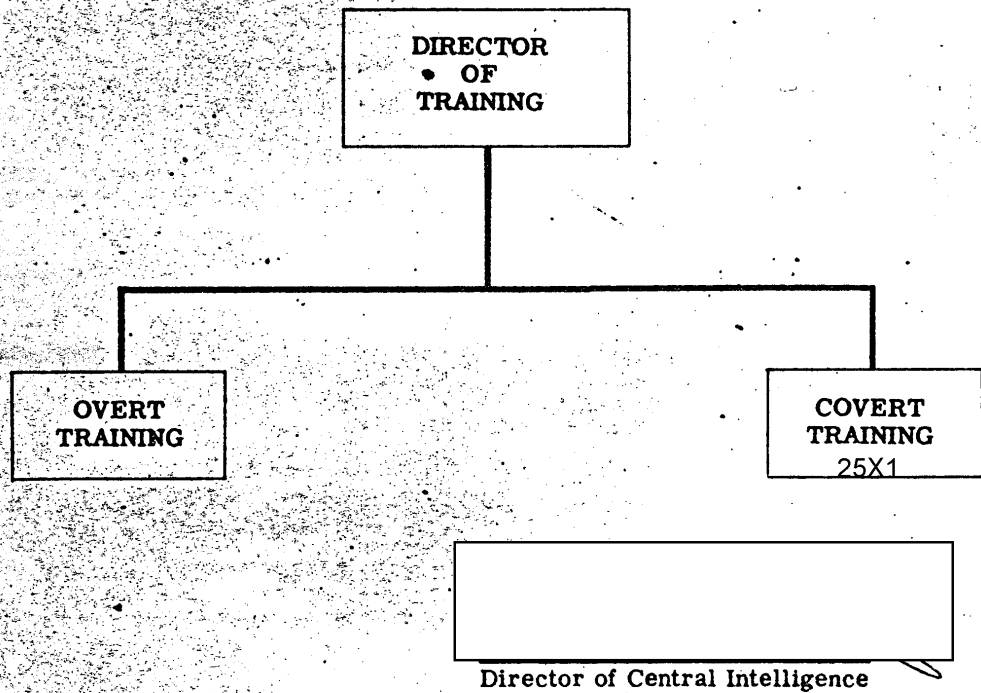

25X1

SECRET

1 July 1951

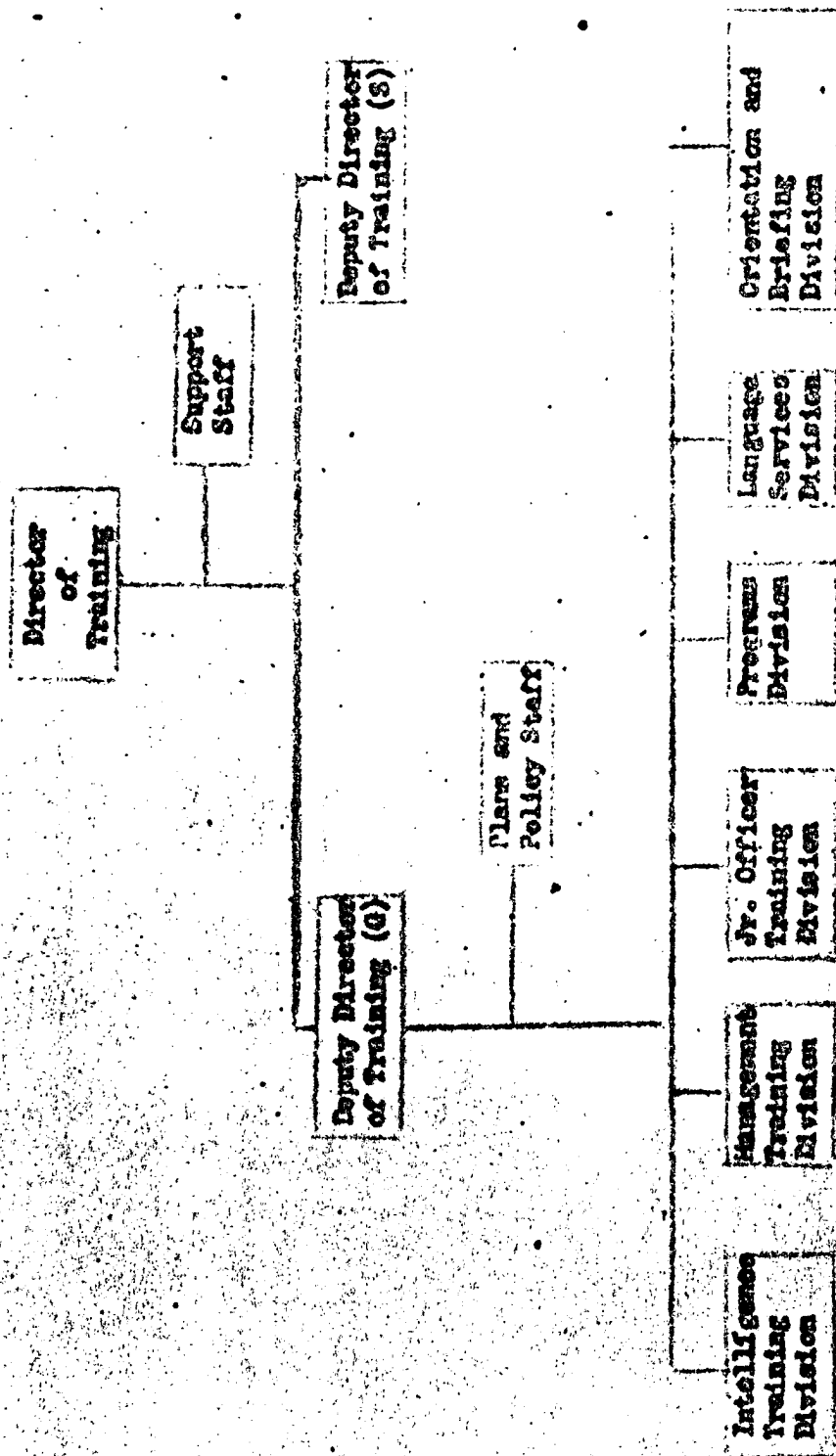

Organization of OTR as of about June 1952.

Above chart, undated, from OTR's History, January 1951 - June 1952 (SECRET), p. 49, in O/DCI/HS files.

OFFICE OF TRAINING

20 MARCH 1953

(SEE ORIG. MANUSCRIPT)

SECRET

Approved For Release 2002/08/28 : CIA-RDP64-00654A000200070001-3

COMMUNICATIONS OFFICE

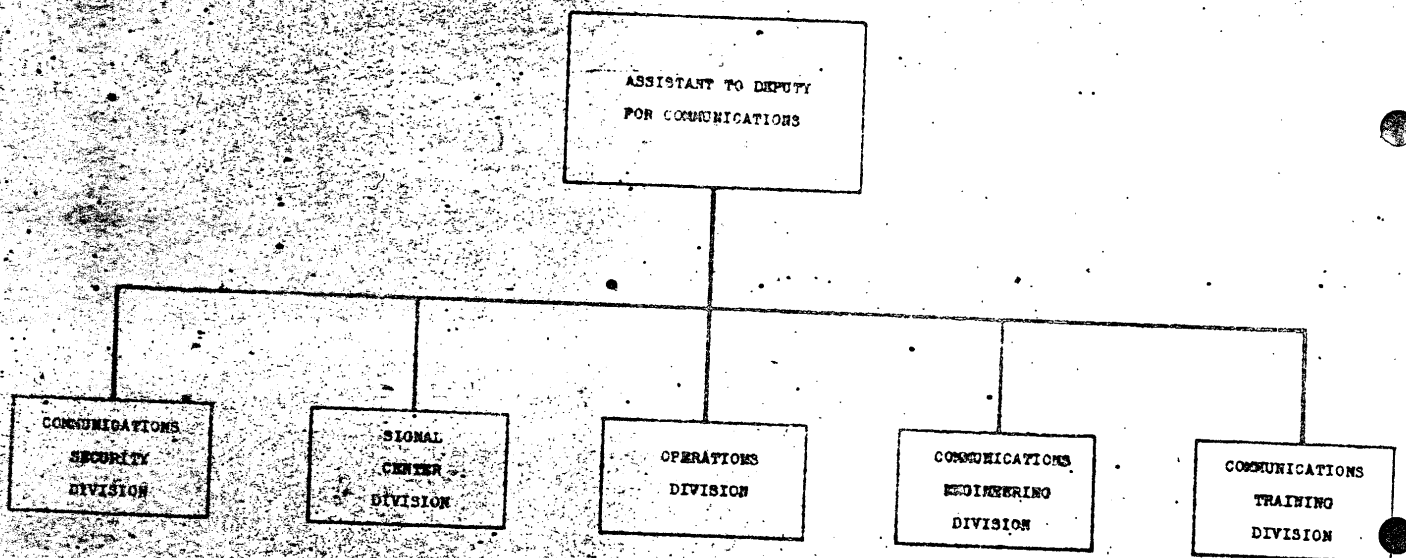

SECRET

Dec. 1, 1950 28

Approved For Release 2002/08/28 : CIA-RDP64-00654A000200070001-3

Security Information

SECRET

ASSISTANT DIRECTOR
OFFICE OF COMMUNICATIONS

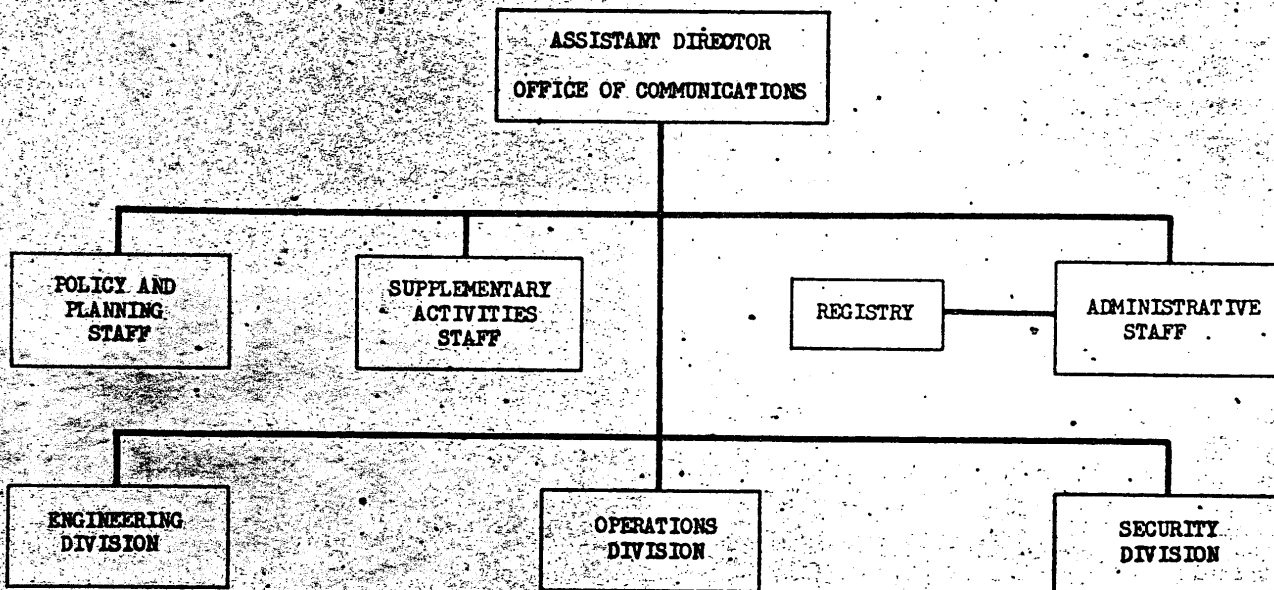

25X1

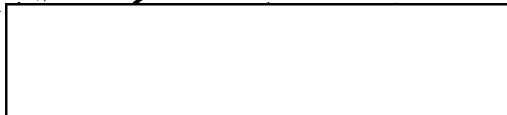

Director of Central Intelligence 1 July 1951

SECRET
Security Information

R 1-110
(Figure 3)

March 20, 1953

SECRET
Security Information

OFFICE OF COMMUNICATIONS

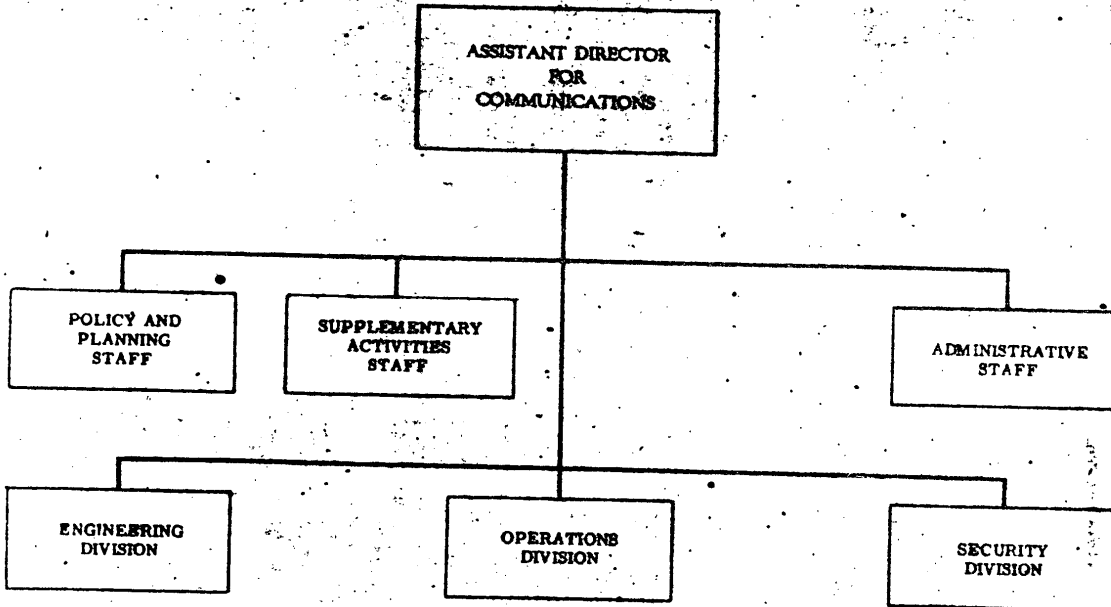

SECRET