

25X1  
25X1

~~SECRET~~



25X1  
25X1



August 24, 1956

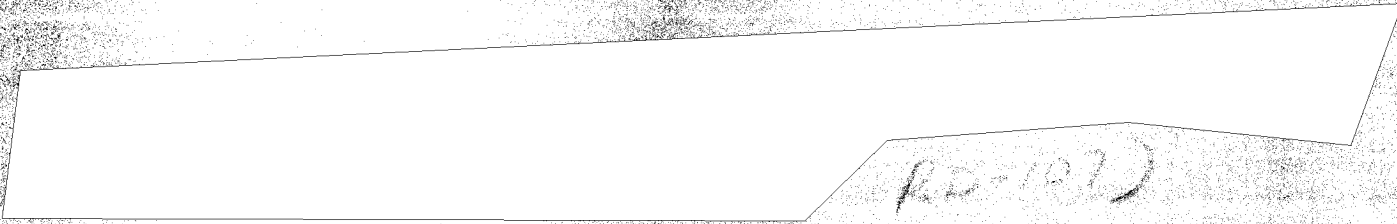

ILLEGIB

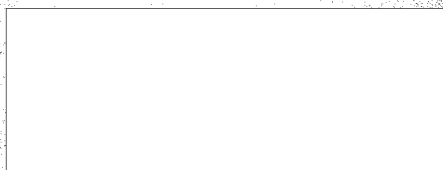

25X1

**Subject:** Submission of additional copies of Technical Proposal

**Reference:** Contract RD-107  
Task Order #4



25X1

Dear Sir:

In accordance with a recent request by [redacted] of your organization, three (3) copies of our original proposal for VLF Antenna Development, are herewith inclosed for your use.

25X1

Very truly yours,



25X1

Contract Administration

FG/jg  
Incl

DOC	43	REV DATE	1 APR 1960	BY	064540
ORIG COMP	256	OPI	56	TYPE	01
ORIG CLASS	S	PAGES	12	REV CLASS	C
JUST	22	NEXT REV	2010	AUTH:	NR 103

~~SECRET~~

CONFIDENTIAL

~~CONFIDENTIAL~~

~~SECRET~~

(PROPOSAL FOR VLF ANTENNA DEVELOPMENT)

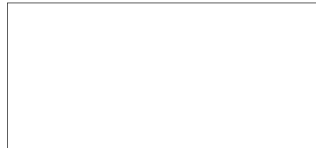

25X1

July, 1956

DOC	REV	DATE	1 APR 1980	BY	064540
ORIG COMP	256	UPI	56	TYPE	30
ORIG CLASS	7	VALUES	111	REV CLASS	C
JUST	2	NEXT REV	2010	AUTH:	HR 70-2



25X1

~~SECRET~~



~~CONFIDENTIAL~~

**CONFIDENTIAL****I. SUMMARY**

It is proposed to undertake an additional task on the Ferrite Antenna Development Program presently underway. The present program is described in a "Proposal for Ferrite Antenna Development" and designated by [redacted]

25X1

[redacted] dated January 1956. A continuation is described in "Proposal for Additional Ferrite Antenna Development, Phase C" designated by [redacted]

25X1

25X1

[redacted] dated May 1956. Briefly the work under these proposals is as follows:

25X1

Phase A: (1) Design, construction and delivery of twenty narrow band units, tunable over a calibrated spectrum of 50 to 250 mcps.

(2) Design, construction and delivery of ten wide band (50 to 250 mcps) units.

Phase B: Investigation of the feasibility of a broadband ferrite antenna covering the frequency spectrum 3 to 30 mcps.

Phase C: Investigation of the applicability of ferrite antennas to very low frequencies, nominally 300 to 300,000 cps.

The additional task described in this proposal is to run concurrently with Phases A and B and will be of approximately three months duration. The additional task is to design and fabricate an antenna system which will provide a bandwidth of 2 kilocycles and will operate at a center frequency of approximately 25 kilocycles. The operating temperature will be approximately 20 degrees Centigrade and the output impedance of the system will be 72 ohms. The complete antenna will be designed to be readily demountable for a man-pack transport.

**II. PROPOSED PROGRAM**

Several methods appear to offer a possible solution to the problem of designing a VLF antenna system which will operate at a frequency of approximately

**CONFIDENTIAL**

# CONFIDENTIAL

25 kilocycles and possess the properties of high sensitivity and broad bandwidth. One method consists of fabricating an antenna system containing approximately 20 separate demountable ferrite antennas, each having a bandwidth of 100 cps. Each antenna would be tuned to a slightly different frequency and the combination would give a total bandwidth of 2 kilocycles. Attached to the base of each antenna would be a low noise transistor preamplifier. After preamplification a summation of the twenty individual signals would be obtained by feeding the 20 preamplifiers into a summation amplifier. The transistor amplifiers will be explained in more detail in a latter portion of this proposal. Figure 1 illustrates how the overall system will be connected, and Figure 2 shows how the output from each antenna is combined to give a total bandwidth of 2 kilocycles.

Some problems requiring investigation in a system composed of 20 narrow band elements are as follows: (1) the construction of narrow band units having a Q of as high as 200 at 25 kilocycles is marginal with presently available ferrite materials so that it may be necessary to compromise on a Q of 100 and a 10 element antenna system, (2) the packaging of the antenna elements in such a manner as to minimize the effects of mutual coupling, and (3) the selection of transistor type and operating conditions to give a noise figure for the preamplifier of as close to zero db as possible.

# CONFIDENTIAL

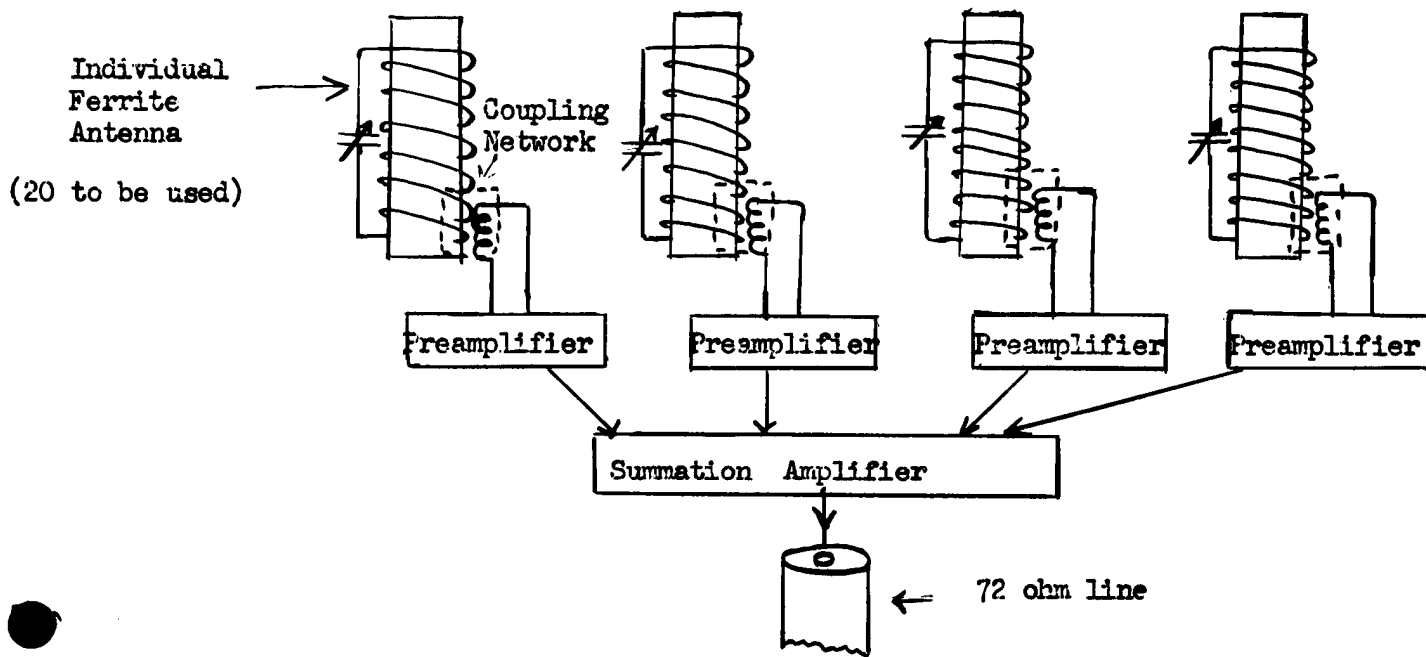

FIGURE 1

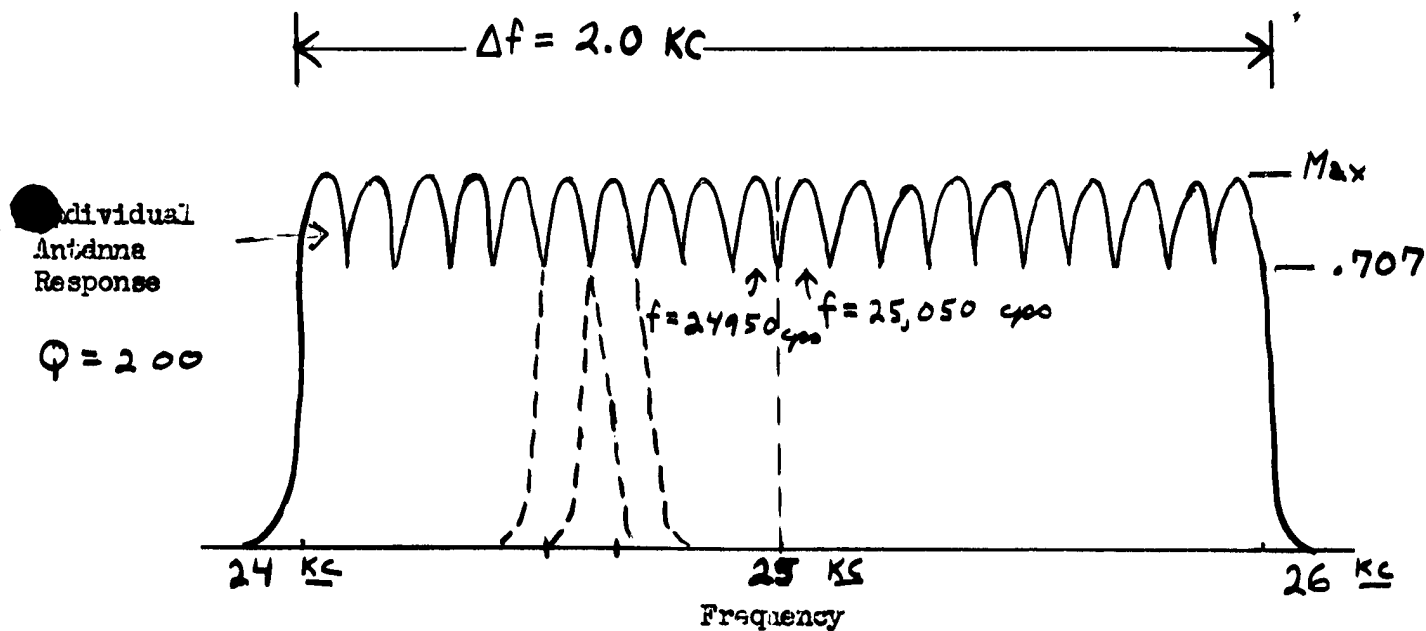

FIGURE 2

Other methods of designing a VLF antenna system will be considered. One very promising method consists of adding a number of relatively low Q ferrite antenna elements in series with one capacitor to resonate the total inductance to the desired center frequency of approximately 25 kilocycles. The series element method is illustrated in Figure 3.

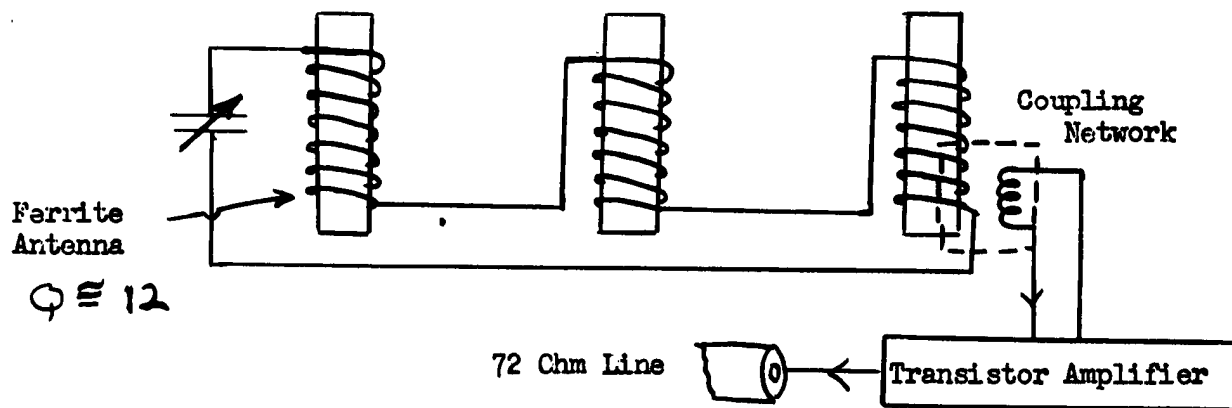

FIGURE 3

Previous work on ferrite loops by other workers<sup>(1)</sup> has indicated the desirability of maintaining a high length/diameter ratio in each element and adding additional ferrite material by connecting windings of spaced rods in series as in Figure 3. Since all elements contribute at all frequencies but the Q is much lower (Q of approximately 12) an analysis or experiment is required to determine whether the first or second method gives a greater effective height for the antenna system.

(1) H. Blok and J. J. Rietveld, "Inductive Aerials in Modern Broadcast Receivers", Philips Technical Review, Vol. 16, January 1955.

Still another method would involve an increase in the cross sectional area of the antenna. This could be accomplished by combining a group of smaller rods into one large bundle as illustrated in Figure 4.

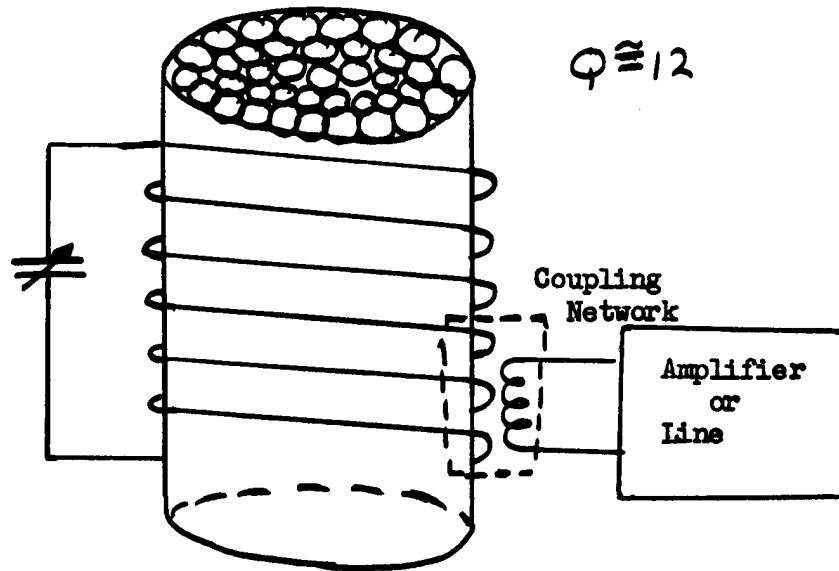

FIGURE 4

With the configuration of Figure 4 the pickup by the antenna would be greater due to a larger volume of ferrite material. The antenna would be a low Q system and coupled to a transistor preamplifier or possibly directly to a 72 ohm line by a suitable impedance transformation. The configuration of Figure 4 does not appear to make as efficient use of ferrite material as the arrangements shown in Figures 1 and 3.

The final design of the transistor circuitry will be dependent on the antenna configuration found most suitable. In view of this, several amplifier designs will be described. In the event that a number of separately tuned high-Q antennas are used, it will be necessary to have a preamplifier for each antenna. It has been found experimentally that a conventional grounded emitter

transistor amplifier stage having a collector voltage of 5 volts and an emitter current of 1 ma. (a commonly used operating point) yields a noise figure of 26 db. If the collector voltage is lowered to 1 volt and the emitter current to 100 microamps the noise figure is reduced to 3 db, which should provide a satisfactory pre-amplifier. A diagram of a low noise amplifier stage is shown below:

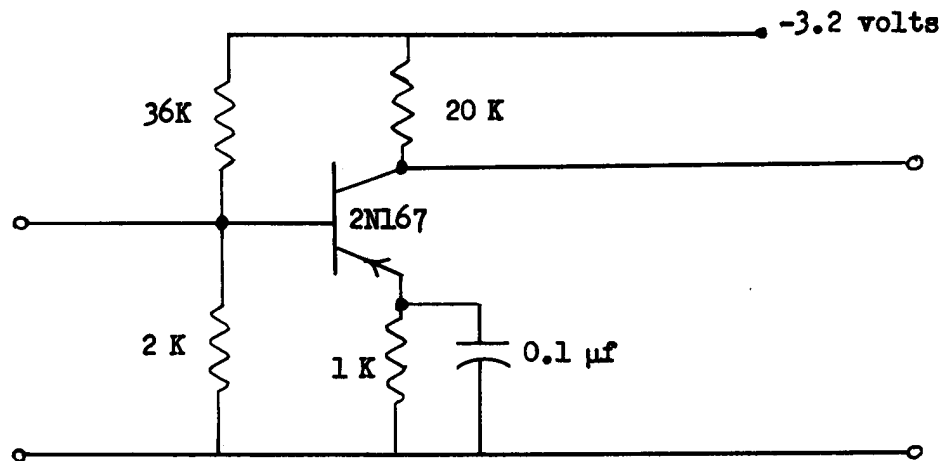

FIGURE 5

A brief discussion of the problem of summing multiple preamplifier outputs will be given. A vacuum tube is essentially a voltage amplifier and the input or grid circuit consumes negligible power at low frequencies. The transistor, however, is a current (and hence a power) amplification device and requires power to drive it. The low noise criterion necessitates a minimum number of stages, and thus impedance matching must be carefully observed to ensure maximum efficiency. The matching of the outputs of the preamplifiers to the input of the summation amplifier presents a difficult problem. If it is assumed that the outputs of 20 preamplifiers are connected in parallel for the purpose of signal addition



and that each amplifier has an output impedance of  $Z_o$ , then the combined output impedance is  $Z_o/20$ .

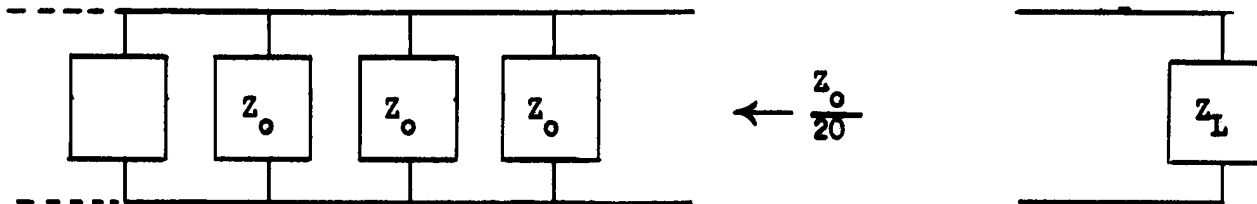

FIGURE 6

The load impedance  $Z_L$  must be low compared to  $Z_o/20$  or else a given amplifier will see as its load the combined impedance of the other 19 stages and little power will be transferred to the load. If  $Z_L$  is made small, however, poor efficiency results since the optimum or matched condition for any stage is  $Z_o = Z_L$ . A similar matching problem arises if the outputs of the preamplifiers are connected in series.

One proposed solution for this problem is as follows: Again assume that 20 stagger-tuned antennas are used. These antennas can be divided into five groups with four antennas in each group. The four antennas in each group are chosen so that they differ in frequency as much as possible. The groups could be: Group 1 - antennas 1, 6, 11, and 16; Group 2 - antennas 2, 7, 12 and 17; Group 3 - antennas 3, 8, 13, and 18; etc. If the four antennas in each group are connected in series, each antenna is essentially a short circuit for the other three antennas inasmuch as they are tuned to different frequencies. Thus the signal summation within the groups can be achieved with little power loss. With this system the summation amplifier need only add the signals from the five antenna groups and hence the matching problem is considerably reduced.

Following the summation amplifier would be as many transistor amplifier stages as are necessary to bring the signal power to the required level. The final stage would be a grounded collector stage (analogous to the vacuum tube cathode follower stage). This stage has a very low output impedance for matching the 72 ohm line.

The current drain for the combined amplifier (preamplifiers, summation amplifier, and additional amplifiers) would be very small - 2 to 5 ma. This should ensure long battery life.

A block diagram for the completed amplifier system follows:

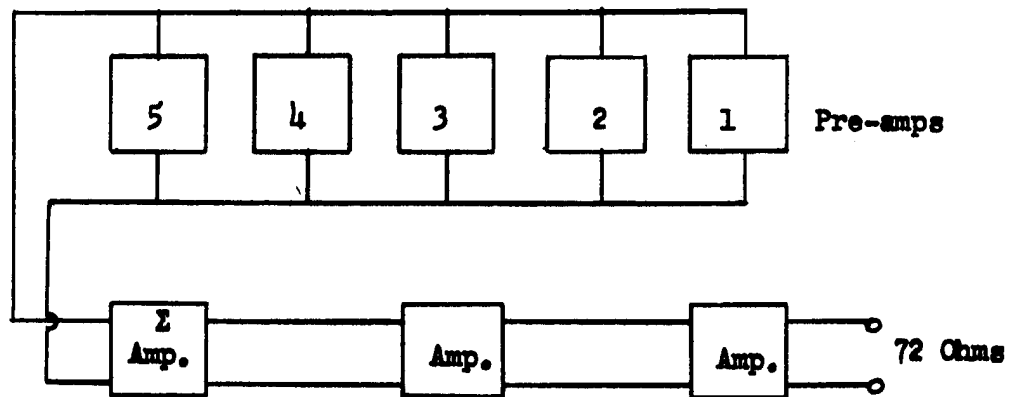

FIGURE 7

If the final antenna design contemplates a single low-Q unit, the transistor circuitry reduces to a single amplifier with the special properties of low noise and low output impedance. The low-noise amplifier stage described previously could be used as the first stage of this amplifier. A grounded collector would again be used for the output stage.

The following three-stage amplifier might be constructed for use in antenna testing. It incorporates a low-noise input stage and the low impedance output stage. This amplifier has a voltage gain of 45 db. which is reasonable considering that the voltage gain of the last stage is less than unity. A secondary winding of about 10 turns is used to match the antenna to the low impedance input of the transistor.

CONFIDENTIAL

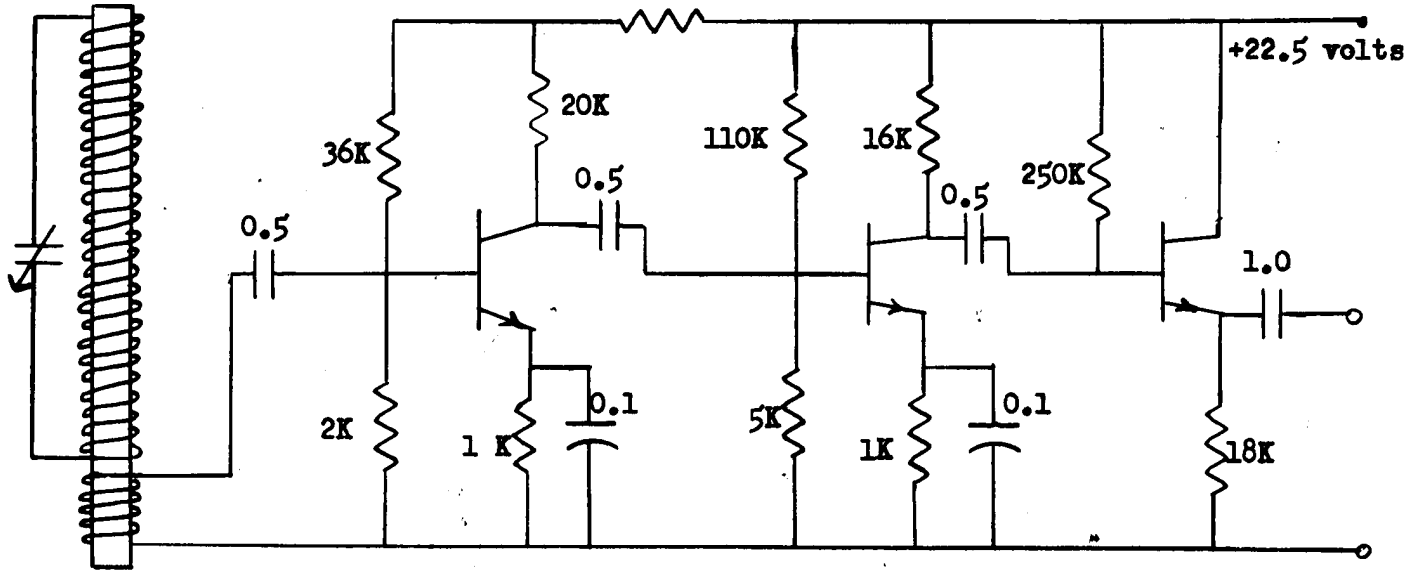

Figure 8

Proposed methods of testing the antenna will be discussed briefly. It is assumed that the antenna will couple principally to the magnetic field component of a VLF radiated wave. Therefore, a loop can be used to generate an induction field which will simulate far field conditions. It is likely that a large loop of perhaps 10 feet diameter will be necessary to generate the induction field for testing. The large diameter loop will allow the antenna under test to be placed at the center of the loop in known field conditions. If it is desired to compare the efficiency of various methods of obtaining a wide-band VLF antenna, the large calibrated loop should be particularly useful. If the frequency and time of operation of VLF stations can be determined it will also be desirable to set up the antenna and a suitable amplifier in an area sufficiently remote from 60 cycle harmonic fields.

CONFIDENTIAL

**CONFIDENTIAL**

III. MANPOWER REQUIREMENTS AND WORK SCHEDULES

It is anticipated that approximately 13 weeks will be required for the development of a suitable VLF antenna. Whether the final deliverable model can be completed within the 13 week period will depend upon the availability of suitable quantity of ferrite materials and/or availability of shop work. It is anticipated that two junior engineers working under the supervision of a senior engineer will carry out the basic testing of proposed materials and designs. A mechanical designer will work out the details of the demountable antenna for man-pack transport. Following manufacture and assembly of the final model, tests will be conducted to evaluate the performance and guide final adjustments.

- 10 -

**CONFIDENTIAL**