

CONFIDENTIAL



**TECHNICAL
PUBLICATION**

**NATIONAL PHOTOGRAPHIC
INTERPRETATION CENTER**

A REVIEW OF COLOR SCIENCE AND COLOR AERIAL RECONNAISSANCE

Declass Review by NIMA / DoD

CONFIDENTIAL

NPIC/R-03/72

JANUARY 1972

GROUP 1: EXCLUDED FROM
AUTOMATIC DOWNGRADING
AND DECLASSIFICATION

WARNING

This document contains information affecting the national defense of the United States, within the meaning of Title 18, sections 793 and 794, of the U.S. Code, as amended. Its transmission or revelation of its contents to or receipt by an unauthorized person is prohibited by law.

~~CONFIDENTIAL~~

TECHNICAL PUBLICATION

A REVIEW OF COLOR SCIENCE AND
COLOR AERIAL RECONNAISSANCE

January 1972

NATIONAL PHOTOGRAPHIC INTERPRETATION CENTER

~~CONFIDENTIAL~~

CONFIDENTIAL

TABLE OF CONTENTS

| | <u>Page</u> |
|-------------------------------------------------------------------------------------|-------------|
| 1.0 INTRODUCTION | 1 |
| 1.1 PURPOSE AND SCOPE | 1 |
| 1.2 FORMAT | 2 |
| 2.0 THE PHYSIOLOGICAL AND PSYCHOLOGICAL ASPECTS OF COLOR VISION | 3 |
| 2.1 THE ANATOMY AND FUNCTION OF THE VISUAL SYSTEM AS RELATED TO COLOR | 3 |
| 2.2 THE COLOR SENSITIVITY OF THE VISUAL SYSTEM | 9 |
| 2.2.1 Luminous Range | 9 |
| 2.2.2 Spectral Range | 11 |
| 2.2.3 Geometric Extent of the Color Zones | 13 |
| 2.3 COLOR PERCEPTUAL PHENOMENA | |
| 2.3.1 Area Effect | 16 |
| 2.3.2 Simultaneous Contrast and Edge Effects | 17 |
| 2.3.3 Spreading Effects | 19 |
| 2.3.4 After Images | 19 |
| 2.3.5 Color Constancy | 20 |
| 2.3.6 Irradiation | 21 |
| 2.3.6.1 Explanation of Irradiation | 21 |
| 2.3.6.2 Additional Complications of Mach Bands for Photointerpretation | 23 |
| 2.3.7 Adaptation | 24 |
| 2.4 DEPTH PERCEPTION AND COLOR | 25 |
| 2.4.1 Perceptual Cues of Depth | 25 |
| 2.4.1.1 Monocular Cues | 25 |
| 2.4.1.2 Binocular Cues | 26 |
| 2.4.2 Effect of Color on Cues | 28 |
| 2.4.3 Chromastereopsis | 28 |
| 2.4.4 The Pulfrich Phenomenon | 29 |
| 2.5 COLOR CAPABILITIES AND SKILLS | 29 |

CONFIDENTIAL

TABLE OF CONTENTS (Continued)

| | <u>Page</u> |
|----------------------------------------------------------------------------------------------------------------------|-------------|
| 2.5.1 Color Discrimination | 29 |
| 2.5.2 Color Memory | 30 |
| 2.5.3 Color Naming | 32 |
| 2.5.4 Color Matching (see also 3.4 COLORIMETRY) | 32 |
| 2.6 INDIVIDUAL DIFFERENCES IN COLOR PERCEPTION | 34 |
| 2.6.1 Defective Color Vision | 34 |
| 2.6.1.1 Types of Color Vision Defects | 35 |
| 2.6.1.2 Congenital versus Acquired Color-Vision Defects | 36 |
| 2.6.1.3 The Effects of Age on Color Perception | 36 |
| 2.6.2 Color-Vision Tests | 37 |
| 2.6.2.1 Pseudoisochromatic Chart Tests (PIC) | 37 |
| 2.6.2.2 The Farnsworth-Munsell 100-Hue Test (FMT) | 38 |
| 2.6.2.3 The Inter-Society Color Council Color Aptitude Test (ISCC-CAT) | 38 |
| 2.6.2.4 The Burnham-Clark-Munsell Color-Memory Test (BCMS) | 39 |
| 2.6.2.5 Campimeter Test | 40 |
| 2.6.2.6 Explanation of Test Battery Usage | 40 |
| 2.7 REFERENCES | 41 |
| 3.0 THE PHYSICS OF COLOR | 46 |
| 3.1 THE PHYSICAL ASPECTS OF COLOR | |
| 3.2 THE ADDITIVE AND SUBTRACTIVE CONCEPT OF COLOR REPRODUCTION | 53 |
| 3.2.1 The Additive Method of Color Reproduction | 54 |
| 3.2.2 The Subtractive Method of Color Reproduction | 54 |
| 3.3 COLOR SYSTEMS | 60 |
| 3.3.1 Munsell System | 60 |
| 3.3.2 CIE System | 62 |
| 3.3.3 Lovibond System | 65 |
| 3.3.4 Ostwald System | 65 |
| 3.3.5 DIN System | 67 |
| 3.3.6 Densitometric Munsell System | 69 |
| 3.3.7 ISCC-NBS System | 69 |
| 3.3.8 NuHue, Plochere, Ridgway, Maerz and Paul, Villalobos, Textile Color Card Association, and Methuin | 70 |

CONFIDENTIAL

TABLE OF CONTENTS (Continued)

| | <u>Page</u> |
|----------------------------------------------------------------------------------------------------------------|-------------|
| 3.4 COLORIMETRY--THE MEASUREMENT OF COLOR | 70 |
| 3.4.1 Instrumental Colorimetry | 73 |
| 3.4.1.1 Recording Spectrophotometer | 73 |
| 3.4.1.2 Tristimulus Colorimeter | 75 |
| 3.4.2 Visual Colorimetry | 75 |
| 3.4.3 Treatment of Colorimetric Data and Error Analysis | 77 |
| 3.4.4 Metamerism and Metameric Colors | 78 |
| 3.4.5 Color Differences and Tolerances | 81 |
| 3.4.6 Color Rendering and Color-Rendering Indices | 83 |
| 3.5 COLOR DENSITOMETRY | 83 |
| 3.5.1 Specular and Diffuse Density | 85 |
| 3.5.2 Analytical and Integral Densitometry | 85 |
| 3.6 REFERENCES | 89 |
| 4.0 COLOR AERIAL PHOTOGRAPHY | 94 |
| 4.1 COLOR-FILM THEORY | 94 |
| 4.2 PHOTOGRAPHIC PROPERTIES OF SELECTED AERIAL FILMS | 99 |
| 4.2.1 Color Films | 99 |
| 4.2.2 False-Color Films | 101 |
| 4.2.3 Spectrazonal or Multispectral Film and Techniques | 102 |
| 4.2.4 Additive Color Separations | 103 |
| 4.3 EFFECTS OF TARGET AND ACQUISITION PARAMETERS ON COLOR AERIAL PHOTOGRAPHY AND COLOR PERCEPTION | 103 |
| 4.3.1 Colorimetric Properties of Selected Natural and Man- Made Targets | 103 |
| 4.3.2 Effects of the Atmosphere and Sun Angle | 108 |
| 4.3.3 Effects of Lenses and Lens Aberrations | 114 |
| 4.3.4 Effects of Platform and Camera Vibration | 114 |
| 4.4 EFFECTS OF FILM AND PROCESSING PARAMETERS ON COLOR AERIAL PHOTOGRAPHY AND COLOR PERCEPTION | 114 |

CONFIDENTIAL

TABLE OF CONTENTS (Continued)

| | <u>Page</u> |
|--------------------------------------------------------------------------------------------------------------------------------|-------------|
| 4.4.1 Effects of Granularity | 114 |
| 4.4.2 Effects of Film Variance | 115 |
| 4.4.3 Effects of Processing Variance | 116 |
| 4.5 REFERENCES | 117 |
| 5.0 APPLIED ASPECTS OF COLOR AND COLOR PERCEPTION IN IMAGE INTERPRETATION | 121 |
| 5.1 INTERPRETATION OF COLOR FILMS | 121 |
| 5.1.1 Theoretical Advantages of Color Films | 122 |
| 5.1.2 Experimental Comparisons of Color Films With Black and White Films | 123 |
| 5.1.3 Operational Findings on Color Film and Color-Imaging Techniques | 123 |
| 5.1.3.1 Natural Color Films (see 4.2.1 Color Films) . . | 124 |
| 5.1.3.1.1 Advantages | 124 |
| 5.1.3.1.2 Disadvantages | 125 |
| 5.1.3.2 Color Infrared Film (Ektachrome Infrared 8443, See 4.2.2 False-Color Films) | 126 |
| 5.1.3.2.1 Advantages | 126 |
| 5.1.3.2.2 Disadvantages | 127 |
| 5.1.3.3 Additive Color Separation (See 4.4.2 Additive Color Separations) | 127 |
| 5.1.3.3.1 Advantages | 127 |
| 5.1.3.3.2 Disadvantages | 128 |
| 5.1.3.4 Spectrazonal or Multispectral Techniques (See 4.2.3 Spectrazonal or Multispectral Film and Techniques) | 129 |
| 5.1.3.4.1 Advantages | 129 |
| 5.1.3.4.2 Disadvantages | 129 |
| 5.1.3.5 Black and White Infrared (Kodak Infrared Aerographic Film, See 4.2.4 False-Color Films) | 130 |
| 5.1.3.5.1 Advantages | 130 |
| 5.1.3.5.2 Disadvantages | 130 |
| 5.1.4 Operational Findings on the Interpretation of Targets and Backgrounds on Color Films | 130 |
| 5.1.4.1 Tactical Targets | 131 |
| 5.1.4.2 Strategic Targets | 132 |
| 5.1.4.3 Cultural Objects | 133 |
| 5.1.4.4 Vegetation Types | 133 |

TABLE OF CONTENTS (Continued)

| | <u>Page</u> |
|------------------------------------------------------------------------------------|-------------|
| 5.1.4.5 Soils | 134 |
| 5.1.4.6 Water | 134 |
| 5.1.4.7 Geologic Features | 138 |
| 5.2 THE MENSURATION OF COLOR FILMS | 138 |
| 5.3 INTERPRETATION TECHNIQUES AND COLOR FILMS | 139 |
| 5.3.1 Stereoscopic Viewing | 139 |
| 5.3.2 Magnification | 139 |
| 5.3.3 Scanning Strategies | 140 |
| 5.3.4 Multisensor Viewing | 140 |
| 5.3.5 Change Detection | 140 |
| 5.3.6 Reporting Strategies | 141 |
| 5.4 ENHANCING THE INTERPRETATION OF COLOR FILMS | 143 |
| 5.4.1 Enhancement During Acquisition | 143 |
| 5.4.1.1 Haze Filters | 143 |
| 5.4.1.2 Antivignetting Filters | 143 |
| 5.4.1.3 Narrow-Band Filters | 144 |
| 5.4.2 Enhancement During Processing | 144 |
| 5.4.2.1 Color Separation Negatives | 144 |
| 5.4.2.2 Color Balance | 144 |
| 5.4.3 Enhancement During Interpretation | 144 |
| 5.4.3.1 Color Filters | 145 |
| 5.4.3.2 Colored Lights | 145 |
| 5.5 ILLUMINATION CONDITIONS AFFECTING THE PERCEPTION OF COLOR IMAGERY | 145 |
| 5.5.1 Illuminant Specifications for Light Tables | 145 |
| 5.5.1.1 Intensity | 145 |
| 5.5.1.2 Spectral Distribution | 146 |
| 5.5.2 Illuminant Specifications for Ambient Lighting | 146 |
| 5.6 REFERENCES | 147 |
| 6.0 GLOSSARY | 156 |
| 7.0 SUGGESTED READINGS | 162 |
| 7.1 GENERAL REFERENCES | 162 |

CONFIDENTIAL

TABLE OF CONTENTS (Continued)

| | <u>Page</u> |
|------------------------------------------------------------------|-------------|
| 7.2 ANATOMY AND PHYSIOLOGY OF COLOR VISION | 163 |
| 7.3 PSYCHOLOGICAL AND PSYCHOPHYSICAL ASPECTS OF COLOR VISION . . | 164 |
| 7.4 COLOR VISION TESTS | 165 |
| 7.5 PHYSICS OF COLOR | 166 |
| 7.6 COLOR SYSTEMS | 167 |
| 7.7 COLORIMETRY AND COLOR DENSITOMETRY | 168 |
| 7.8 COLOR AERIAL RECONNAISSANCE | 169 |
| 8.0 INDEX | 170 |

LIST OF FIGURES

| | |
|---------------------------------------------------------------------------------------------|----|
| FIGURE 2.1 HORIZONTAL SECTION OF THE EYE | 5 |
| FIGURE 2.2 THE STRUCTURE OF THE HUMAN RETINA | 7 |
| FIGURE 2.3 THE COURSE OF VISUAL STIMULI AND THE CORRESPONDING FIELDS OF VISION | 8 |
| FIGURE 2.4 DISTRIBUTION OF THE FOVEAL PHOTOCHROMATIC INTERVAL . . | 10 |
| FIGURE 2.5 BEZOLD-BRÜCKE PHENOMENON | 11 |
| FIGURE 2.6 PHOTOPIC LUMINOSITY FUNCTION (solid line) | 14 |
| FIGURE 2.7 THE GEOMETRIC COLOR ZONES OF THE EYE | 15 |
| FIGURE 2.8 SIMULTANEOUS COLOR CONTRAST | 18 |
| FIGURE 2.9 BRIGHTNESS CONTRAST | 18 |

CONFIDENTIAL

CONFIDENTIAL

LIST OF FIGURES (Continued)

| | <u>Page</u> |
|------------------------------------------------------------------------------------------------------------|-------------|
| FIGURE 2.10 ILLUSTRATION OF THE PHENOMENON OF MACH BANDS | 22 |
| FIGURE 2.11 ILLUSTRATION OF DEPTH PERCEPTION AND RETINAL DISPARITY | 27 |
| FIGURE 2.12 NUMBER OF JUST-PERCEPTIBLE STEPS BETWEEN NEUTRAL AND THE SPECTRUM COLORS | 31 |
| FIGURE 2.13 DIFFERENTIAL COLOR SENSITIVITY | 31 |
| FIGURE 3.1 THE ESSENTIAL ELEMENTS OF COLOR | 47 |
| FIGURE 3.2 THE ELECTROMAGNETIC SPECTRUM | 48 |
| FIGURE 3.3 THE SPECTRAL ENERGY DISTRIBUTION FOR A 40-WATT INCANDESCENT LAMP | 49 |
| FIGURE 3.4 THE SPECTRAL ENERGY DISTRIBUTION FOR A 40-WATT DAYLIGHT FLUORESCENT LAMP | 49 |
| FIGURE 3.5 THE SPECTRAL ENERGY DISTRIBUTION OF THE LIGHT REACHING THE OBSERVER'S EYE | 51 |
| FIGURE 3.6 THE COLOR STIMULUS EXPERIENCED BY THE OBSERVER | 52 |
| FIGURE 3.7 ADDITIVE COLOR PHOTOGRAPHY - TAKING THE PICTURE | 55 |
| FIGURE 3.8 ADDITIVE COLOR PHOTOGRAPHY - RECONSTRUCTING THE PICTURE | 56 |
| FIGURE 3.9 SPECTRAL TRANSMITTANCE CURVES FOR IDEALIZED CYAN, MAGENTA, AND YELLOW DYES | 57 |
| FIGURE 3.10 A COLOR REVERSAL PHOTOGRAPHIC PROCESS | 59 |
| FIGURE 3.11 THE CONCEPT OF THE MUNSELL COLOR SYSTEM | 61 |
| FIGURE 3.12 THE CIE COLOR SYSTEM | 63 |
| FIGURE 3.13 THE OSTWALD COLOR SYSTEM | 66 |
| FIGURE 3.14 THE LINES OF CONSTANT DIN-FARBTON AND DIN-SÄTTIGUNG PLOTTED ON A 1931 CIE DIAGRAM | 68 |

CONFIDENTIAL

CONFIDENTIAL

LIST OF FIGURES (Continued)

| | <u>Page</u> |
|------------------------------------------------------------------------------------------------------------------------------------------------------------------------------|-------------|
| FIGURE 3.15 THE ISCC-NBS HUE NAMES AND ABBREVIATIONS FOR A CONSTANT MUNSELL VALUE OF SIX | 71 |
| FIGURE 3.16 THE ISCC-NBS MODIFIERS FOR A PURPLE HUE | 72 |
| FIGURE 3.17 A SCHEMATIC DIAGRAM OF A SPECTROPHOTOMETER BEING USED TO MEASURE THE SPECTRAL TRANSMITTANCE OF A SAMPLE | 74 |
| FIGURE 3.18 A SCHEMATIC DIAGRAM OF A TRISTIMULUS COLORIMETER . . | 76 |
| FIGURE 3.19 THE SPECTRAL REFLECTANCE CURVES FOR A METAMERIC PAIR OF COLORS | 79 |
| FIGURE 3.20 THE SPECTRAL ENERGY DISTRIBUTIONS FOR THE CIE STANDARD SOURCES A AND C | 79 |
| FIGURE 3.21 THE SHIFT IN THE CIE CHROMATICITY COORDINATES OF A PAIR OF METAMERIC COLORS PRODUCED BY CHANGING FROM CIE STANDARD SOURCE C TO CIE STANDARD SOURCE A . . . | 80 |
| FIGURE 3.22 THE STANDARD DEVIATIONS OF COLOR MATCHES BY OBSERVER PGN, ENLARGED TEN TIMES ON THE 1931 CIE x, y CHROMATICITY DIAGRAM | 82 |
| FIGURE 3.23 A SCHEMATIC DIAGRAM OF A TYPICAL COLOR DENSITOMETER . | 84 |
| FIGURE 4.1 THE CONFIGURATION OF A TYPICAL COLOR FILM | 95 |
| FIGURE 4.2 THE FORMATION AND DEVELOPMENT OF A COLORED IMAGE IN A COLOR-REVERSAL PHOTOGRAPHIC PROCESS | 97 |
| FIGURE 4.3 CIE CHROMATICITY COORDINATES FOR SELECTED NATURAL AND MAN-MADE TARGETS | 104 |
| FIGURE 4.4 IMAGE DISTORTION CAUSED BY A TURBULENT ATMOSPHERE . . | 109 |
| FIGURE 4.5 LIGHT LOSSES CAUSED BY BOTH ABSORPTION AND SCATTERING IN THE ATMOSPHERE | 111 |
| FIGURE 4.6 DIAGRAM OF THE SUN ANGLE OR SOLAR ALTITUDE AND THE RELATIVE POSITIONS OF THE EARTH, CAMERA PLATFORM, AND THE SUN | 112 |

CONFIDENTIAL

CONFIDENTIAL

LIST OF FIGURES (Continued)

| | <u>Page</u> |
|------------------------------------------------------------------------------------|-------------|
| FIGURE 4.7 VARIATION OF TARGET ILLUMINANCE AS A FUNCTION OF SUN ANGLE | 113 |

LIST OF TABLES

| | |
|-------------------------------------------------------------------------------------------------------------------------------------------------------------------------------|-----|
| TABLE 2.1 WAVELENGTH REGIONS AND HUE NAMES | 12 |
| TABLE 4.1 THE PHOTOGRAPHIC CHARACTERISTICS OF SELECTED AERIAL COLOR FILMS | 100 |
| TABLE 4.2 THE CIE CHROMATICITY COORDINATES, LIGHTNESSES, DOMINANT WAVELENGTHS AND EXCITATION PURITIES FOR THE COLORS OF SELECTED NATURAL AND CULTURAL TARGETS | 105 |
| TABLE 4.3 THE MUNSELL AND ISCC-NBC DESIGNATIONS FOR THE COLORS OF SELECTED NATURAL AND CULTURAL TARGETS | 107 |
| TABLE 5.1 ACCURACY OF CROP IDENTIFICATION ON TRUE COLOR FILM | 135 |
| TABLE 5.2 SOILS OF THE LAC BEVIN BASIN AND THEIR MUNSELL VALUES | 142 |

CONFIDENTIAL

~~CONFIDENTIAL~~

1.0 INTRODUCTION

1.1 PURPOSE AND SCOPE

This review attempts to explain in simple, understandable language the current state of the art of color science and color photography as it relates to high-altitude aerial reconnaissance, and the Center's activities. The review provides the Center with a reference (a) for use by the Center personnel in learning and understanding basic color concepts and technologies (it is not intended to be a textbook or a handbook), (b) to show how color will affect the Center, and (c) to show how color will be used by the Center. For maximum usefulness to the Center, several criteria were used to guide and limit the compilation and writing of the review:

- (1) The material included in the review should be relevant and applicable to the Center's activities and needs. The Center's activity is broad and many technical disciplines are represented. Thus the review is broad in scope, covering the psychology, physiology, and physics of color; color photography; and applied aspects of color imagery and interpretation*. Materials within these broad categories, that were unrelated to the Center's activities are not included. Thus, the reader should not expect to find a complete and comprehensive review.
- (2) The language (terms and concepts) of the review should be nontheoretical and easy to understand so that a wide range of Center personnel can read and understand the material included. For those who wish or need to know technical detail and theory, a number of excellent references in all technical areas are suggested in the report.
- (3) The material should be presented in a straightforward, concise manner so that extraneous words and concepts would not have to be read.
- (4) The material presented should be as up-to-date as possible and based on sound empirical or operationally proven evidence.

* The classified information in this topic area is included in the report entitled "A Review of Color Science and Color Aerial Reconnaissance: An Addendum".

~~CONFIDENTIAL~~

CONFIDENTIAL

- (5) The material should be easily accessed. (To satisfy this criteria, numbered headings are used extensively and an index is included.) It should be noted that, as a result, the review is not an integrated whole, rather many sections stand alone. Cross-referencing between sections is used to help the reader gain a fuller understanding of the material, in the review, pertaining to a particular topic area.

To help satisfy these criteria the writers first performed a comprehensive literature review. Then, individuals working or researching in certain color-related fields were contacted to gather state of the art information. Every attempt has been made to avoid the use of unnecessary technical jargon, lengthy explanations, theoretical considerations, and yet, to give the reader an understanding of the basic terminologies and concepts used in color science and aerial photography.

1.2 FORMAT

This review begins with the physiology and psychology of color vision, which is followed by the physics of color. Color aerial photography is discussed, and the body of the review ends with the applied aspects of color imagery and its interpretation. At the end of each major section is a partial list of references that are considered the most relevant and useful for the review.

Within each section, the format of the sections varies to suit the material presented. In general, the format is continuous and explanatory, but in the last section dealing with applied aspects much of the information was disjointed and, thus, is presented in a more discrete fashion.

To help the reader, a glossary and an index are included, and, within the body of the review, the glossary-defined words are capitalized and underlined. Important words, defined in the text are also capitalized. In addition, a suggested reading list has been included for the reader to find more detailed and theoretical discussions. This reading list is categorized by topic and level of technical difficulty.

CONFIDENTIAL

CONFIDENTIAL

2.0 THE PHYSIOLOGICAL AND PSYCHOLOGICAL ASPECTS OF COLOR VISION

The influx of color imagery into the Center's operation will have at least one fundamental effect; eventually everyone will look at it (as transparencies or prints). The interpreters, printers, photogrammetrists, and audiences of briefings will be seeing color imagery. However, these people may not perceive color in the same way. Where some people see red, others may see orange. An interpreter viewing color imagery through a stereoscope will see colors differently than when he views without the scope. These are but a few examples of many problems which can be anticipated. The importance of these problems to the Center's activities and tasks is difficult to anticipate.

2.1 THE ANATOMY AND FUNCTION OF THE VISUAL SYSTEM AS RELATED TO COLOR

A complete explanation of the physiological basis of color perception cannot be given by the present state of the art. Certain facts are known as to the necessary constituent elements, but how they interact to achieve color vision can be explained only by theories that are partially contradictory.

The purpose of the eye is to focus light rays onto the retina (the light sensitive layer of the eye) and to convert these rays from light energy into electrical-like impulses for transmission by the nervous system. The characteristics of the scene can then be passed up to the interpretative centers of the brain. Further, these characteristics must be coded in some way as to their spatial relationships, color, shades, contrast, etc. To do this, the eyes must be able to move, to focus, and to adapt to fluctuating illumination levels, as a coordinated pair.

The ability of the eyes to move and point specifically at an object is a part of the basis for the relatively high resolution ability of the visual system, because good acuity as well as good color discrimination is concentrated in the central part of the visual field. Very rapid and precise movements of the eyes in mutual coordination are made possible by a set of three pairs of muscles attached to the outside of each eyeball. These muscles move the eye in all directions.

Another set of muscles controls the lids, which in turn protect and lubricate the exposed surfaces of the eye. An added function of lid closure is as a part of the light adaptation process, i.e., the partial or

CONFIDENTIAL

CONFIDENTIAL

complete closure of the lids is one way to regulate the amount of light entering the eye, e.g., squinting in the presence of bright lights.

The external shape of the eyeball is best described as that of two intersecting spheres - a small transparent one in the front and a large opaque one in the rear (see Figure 2.1). The front sphere, the CORNEA, holds a continually changing transparent fluid called the AQUEOUS HUMOR. The wall of the larger sphere has three specific layers: a tough light-proof outer protective coat, the SCLERA; a highly vascularized* nutrient layer, the CHOROID; and an innermost layer of complex and delicate nervous tissue called the RETINA. Within this sphere is a transparent gel, the VITREOUS HUMOR. Separating the two spheres is a curtain-like structure, the IRIS, with a slightly decentered** opening called the PUPIL. The size of this opening is continually changing due to the effects of illumination-level changes and other stimulus conditions. This control of the light level is also a part of the adaptation process of the eye. Directly in back of the iris and in the rear chamber is a small flexible transparent structure (the LENS). Its purpose is to vary the focal length of the eye to form a clear or focused image on the retina as the gaze is shifted to objects at different viewing distances. Muscular action by a structure surrounding the lens, the CILIARY BODY, exerts a force on the lens causing it to change shape and, hence, to alter its focal power. The alteration, known as the ACCOMODATION process (or focusing), is very important to the maintenance of clear imagery in the eye. Focusing ability declines with age--most people become far-sighted with age. These transparent structures, the cornea, the aqueous humor, the lens, and the vitreous humor, comprise the focusing apparatus of the eye. Most of the focusing power of the eye is attributable to the cornea. The lens varies in shape and, hence, optical or focusing power, to permit the position of the image formed by the optics of the eye to fall on the retina.

The innermost layer of the eye, the retina, is composed of nervous and supporting connective tissue, and it is structurally and functionally a forward extension of the brain. It spreads laterally over the entire inner surface at the back of the eyeball. However, its detail discrimination ability and color sensation are clustered in the MACULAR area, a depression in the retina, (see Figure 2.1) situated at the extreme rear of the eye. Further, these abilities are strongest at the apex of the macula known as the FOVEA CENTRALIS. The optical quality of the image formed is also better at this point than anywhere else on the retinal

* The choroid may also be thought of as an extremely dense mass of tiny blood vessels.

** This decentration is a partial basis for a little known illusion (see Chromastereopsis, Section 2.4.3) that may have a bearing on the photointerpretation task.

CONFIDENTIAL

CONFIDENTIAL

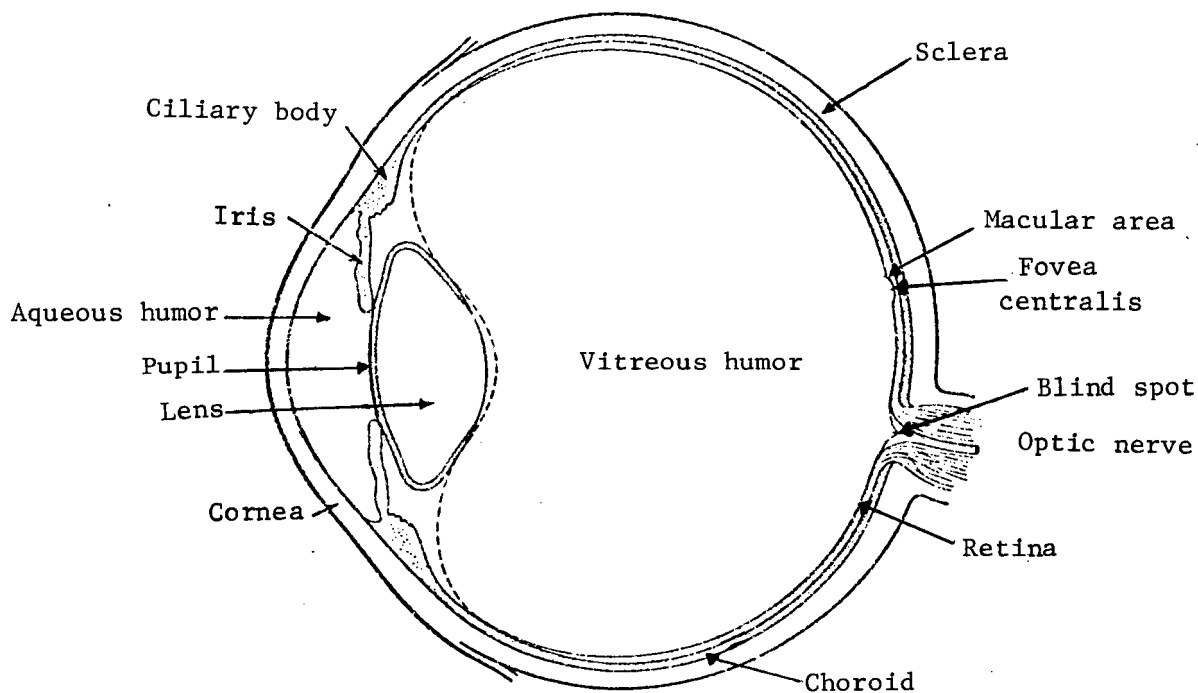

FIGURE 2.1 HORIZONTAL SECTION OF THE EYE

CONFIDENTIAL

CONFIDENTIAL

surface. The periphery of the retina does not have good discrimination for either detail or color. Its greater sensitivity to light, than that of the central retina, is achieved by adding weak signals from a wide area. Primarily, the peripheral retina is an aid in locating objects and in minimizing orientation, both of which must be understood as a part of the total visual process.

The radial or in-depth arrangement of the retina with its 10 well-defined microscopic layers, must be considered. The functional structure is "turned inside out", because the light must pass through the entire retinal structure before striking the light-sensitive or photo-receptive layer of the retina made up of the RODS and CONES (see Figure 2.2). In the rods and cones the light energy is absorbed and initiates chemical changes. The resulting "coded" electrical impulses flow along nerve fibers toward the center of the eye, traveling across a series of three types of nerve cells. The junctions between these nerve cells are known as SYNAPSES. At this stage, indeed even before it has left the eye, the signal is in the initial stages of interpretative processing by the brain.

The prevailing opinion as to the character of the cones and their geometric arrangement is that there are three separate types of cones, each maximally sensitive to a wavelength in the red, green, or blue spectral region. The cones are situated side by side, possibly randomly and possibly clustered to a certain extent, but all at the same depth. The mechanism for the separation of the light energies into color is not well known, other than that it is a function of the cones. The function of the rods has nothing to do with discrimination of colors.

The innermost layer of the retina, the GANGLION FIBER (see Figure 2.2) layer, converges from all lateral directions of the retina to a central exit point, the OPTIC DISC or BLIND SPOT. Here, all of the impulses leave the eye in a flexible cable-like structure, the OPTIC NERVE. The area of the optic nerve exit, since it has no rods or cones (the light receptors), is a true blind spot. The individual is unaware of this, because of two filling-in processes; one, a "mental" process and the other an overlapping by the corresponding image from the other eye. It is possible, however, that with prolonged staring with one eye (with the other eye covered or not being used for some reason) an object could be "lost" because its ocular image was focused on the blind spot.

After leaving the eye, the optic nerves from the two eyes converge in an "X" shaped intersection, (see Figure 2.3) where half of the fibers within the nerve cross to the opposite side and half do not. The bundles of nerve fibers after this crossing are the OPTIC TRACTS. Thus, the fibers from the nasal side of the retina of each eye join with the temporal fibers from the retina of the other eye. All of the fibers from one side of the visual field go to one side of the brain. The individual

CONFIDENTIAL

CONFIDENTIAL

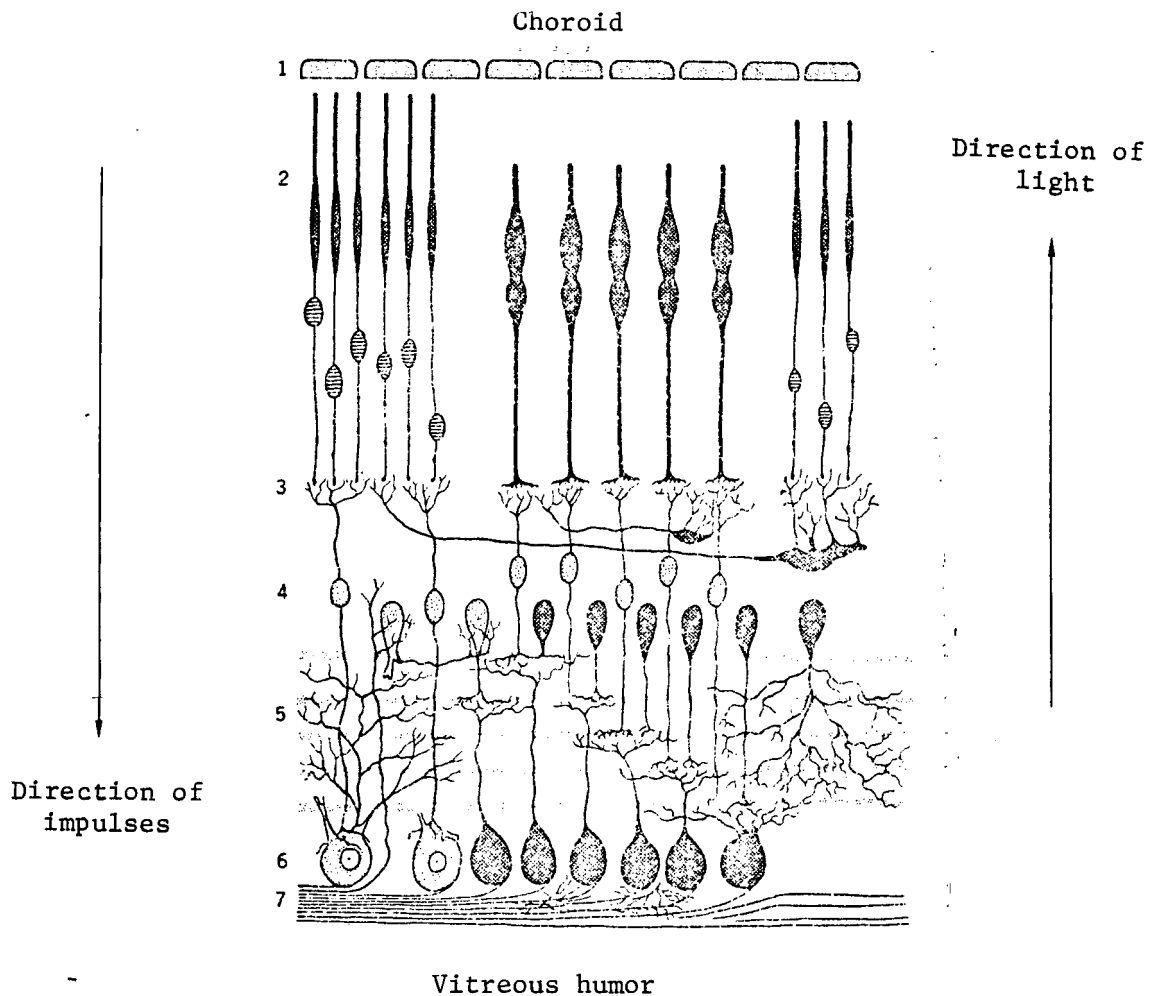
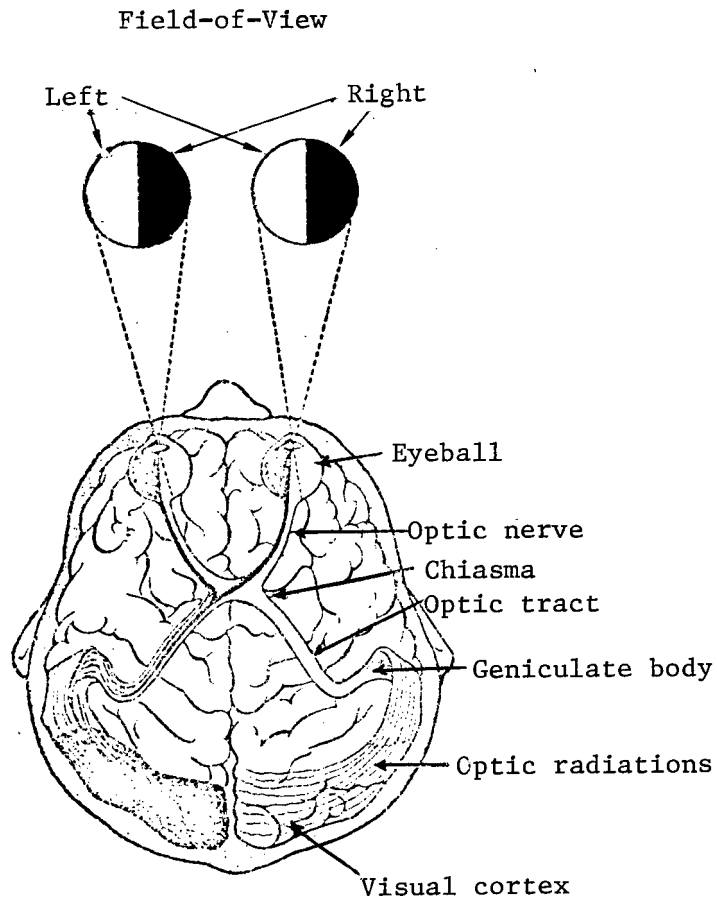

FIGURE 2.2 THE STRUCTURE OF THE HUMAN RETINA. 1, Pigment layer; 2, Rod and cone layer; 3, Synapses; 4, Bipolar cells; 5, Synapses; 6, Ganglion cells; 7, Optic nerve fibers. After Cady, F. E., and Dates, H. B., Illuminating Engineering, New York; John Wiley & Sons, Inc. 1928 (2nd Ed.), p. 233.

CONFIDENTIAL



TOP VIEW OF HEAD

FIGURE 2.3 THE COURSE OF VISUAL STIMULI AND THE CORRESPONDING FIELDS OF VISION.

CONFIDENTIAL

fibers contained in the optic tract at this point are the ganglion cell layer fibers from the eyeball. Some now branch off to the SUPERIOR COLLICULUS, but the majority go on to the region of the LATERAL GENICULATE BODY, a region of numerous synapses that constitute the first switching gap after the eye. From the LATERAL GENICULATE, new nerve fibers, the OPTIC RADIATIONS, carry derivatives of the original signals from the retinal layer to the VISUAL CORTEX of the brain, at which point there is presumably some form of spatial analogue of the viewer's world.

2.2 THE COLOR SENSITIVITY OF THE VISUAL SYSTEM

In a very strict physical sense, color does not exist. Color is an interpretation of the observer's visual impressions of an object or light source primarily related to the combinations of wavelengths of light energy being transmitted (as in a color image), reflected, or generated. As it happens, most people have similar interpretations, and, thus, color interpretations can be thought of as a common experience. People whose color discriminations and descriptions indicate the existence of very similar color vision are called COLOR NORMAL. The range of light intensities and colors that the color-normal eye is sensitive to are described below.

2.2.1 Luminous Range

Although detection of the presence of light is possible at brightnesses as low as 10^{-6} cd/m²*, this is too dim for recognizing hue differences between (or within the area of) light sources. Such discriminations of hue difference do not begin until light intensities exceed 10^{-3} cd/m².

The first hue to be discriminated with an increase of intensity is red. (It also disappears last when luminance is decreased.) As luminance is increased, more colors gradually become distinguishable from each other, but not at the same time, i.e., light levels. Thus, there are two thresholds; the lower is the detection of the source as a light, and the higher is the identification of the source as a hue. The difference between the two thresholds is known as the PHOTOCHROMATIC INTERVAL. However, there is a separate value for each color. The graphical distribution of these values is shown in Figure 2.4.

* Candelas per square meter.

CONFIDENTIAL

CONFIDENTIAL

FIGURE 2.4 DISTRIBUTION OF THE FOVEAL PHOTOCHROMATIC INTERVAL.

If the luminance continues to be raised, color eventually loses its purity or saturation, i.e., begins to wash out. Well below the level of this wash-out effect, a phenomenon known as the BEZOLD-BRÜCKE EFFECT occurs. This is a perceived hue change (without an accompanying change in physical wavelength) with increasing luminance. The graph of this effect is shown in Figure 2.5. Note that the red-yellows and the green-yellows become yellower, and the red-blues and the green-blues become bluer. However, certain hues tend to remain constant or INVARIANT. In some instances, these are given as three distinct wavelengths and in others as four (Committee on Colorimetry, 1953). The former grouping is 478, 505, and 573 nanometers while the latter has been given as 474, 494 (complement), 506, and 571 nanometers. These are similar to but slightly different from the psychological primary hues (see below). They are also similar to and possibly related to the stable or INVARIABLE HUES, a phenomena related to the unchanging perception of a single hue as it falls on different parts of the retina (see 2.2.3 Geometric Extent of the Color Zones).

CONFIDENTIAL

CONFIDENTIAL

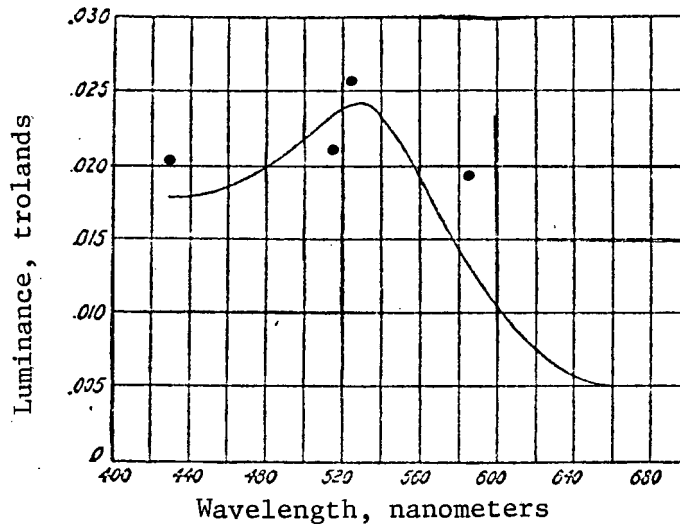
FIGURE 2.5 BEZOLD-BRÜCKE PHENOMENON.

2.2.2 Spectral Range

The normal eye is sensitive to colors of wavelengths ranging from about 380 to 770 nanometers. However, at the extreme ends of this range the sensitivity to light energy is extremely low, i.e., the visual thresholds are very high. Consequently, the range is usually given as a working figure of 400-700 nanometers. This range of visual sensitivities makes up the VISUAL SPECTRUM, a very small part of the total electromagnetic spectrum (see 3.1 THE PHYSICAL ASPECTS OF COLOR).

It is within this range that colors are seen and reliably, i.e., repeatedly with consistent results interpreted by humans with normal color vision. According to LeGrand (1968), 250 hues can be distinguished in side by side comparisons within the spectrum. Halsey and Chapanis (1951) find that this figure shrinks to about 11 if there is no reference or comparison chip immediately and simultaneously adjacent. Alternatively, if saturation and brightness are also allowed to vary, the number of distinguishable colors may reach into the millions.

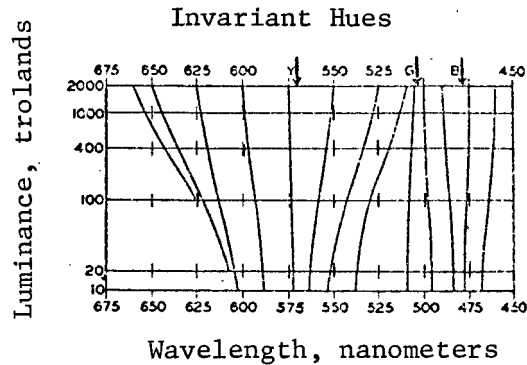
Table 2.1 is a breakdown of wavelengths by prevailing or popular names. These names can be further reduced to those of the psychological primaries, which Evans (1948) notes as blue, green, yellow, and red. These primaries have also been called the UNITARY (Judd, 1963) or UNIQUE HUES in that they seem to have no other contaminating colors. Combinations of these hues then can be used verbally to describe intermediate hues as in Table 2.1. Unfortunately, these names lack the precision (freedom from ambiguity) needed for other than verbal descriptions. Ingling (1971)*, for example, notes that the blue primary is between 470 and 480 nanometers;

* personal conversation

CONFIDENTIAL

CONFIDENTIAL

TABLE 2.1 WAVELENGTH REGIONS AND HUE NAMES
(Burnham, et al., 1963)

| Approximate Wavelength Region in nanometers | Names |
|---------------------------------------------------|-----------------|
| 380-470 | Reddish Blue |
| 470-475 | Blue |
| 475-480 | Greenish Blue |
| 480-485 | Blue-Green |
| 485-495 | Bluish Green |
| 495-535 | Green |
| 535-555 | Yellowish Green |
| 555-565 | Green-Yellow |
| 565-575 | Greenish Yellow |
| 575-580 | Yellow |
| 580-585 | Reddish Yellow |
| 585-595 | Yellow-Red |
| 595-770 | Yellowish Red |

CONFIDENTIAL

~~CONFIDENTIAL~~

green is an ambiguous in that 75-80 percent of the color-normal population sets unique green at 510 nanometers and the others use 525 nanometers as a reference. Unique yellow is very sharp and consistent at 580 nanometers. No one wavelength is consistently identified as red.

The eye is not equally sensitive to all wavelengths, and people do vary in their sensitivity. Consequently, a statistical composite curve (the solid line in Figure 2.6) known as the PHOTOPIC or LUMINOSITY CURVE of the standard observer has been prepared. This shows the statistically smoothed consensus of human visual sensitivity as a function of wavelength during daylight or in a well-lighted room. It approximates, but is unlikely to match, the visual sensitivity of any single individual.

The dashed line in Figure 2.6 represents the composite sensitivity for vision at night, the SCOTOPIC CURVE. Under dim light conditions, people are sensitive to colors as shown by the scotopic curve. However, the colors are not perceived as such, only as shades of gray. Only under light adapted conditions, i.e., the photopic curve, will colors be perceived. The brightness boundary line between these two stages is about 0.1 millilambert. Anyone who works with color imagery or prints and must see colors clearly to judge color fidelity, balance, or to name colors, must work in a well-lighted area and become light adapted before judging or naming colors.

2.2.3 Geometric Extent of the Color Zones

The sensitivity of the retina for colors progressively decreases from the macula to the periphery. Essentially, a point is reached at which the sensation of color disappears and there is only an awareness of light or no light. Figure 2.7 is a plot of this information on a polar-coordinate diagram. The irregular boundary lines connecting all of the points (within which there is color perception - outside of which there is none) for a particular color is the ISOPTER for that color. The isopter is a statistical concept--a guide and not an exact measurement for any single person. Such isopters are illustrated in Figure 2.7 for the more important principal colors. Thus, green has the smallest zone, followed by red, yellow, and blue, respectively. However, people may have varying individual diagrams, e.g., different sequences of loss or interlacing of the isopters.

The color zones as measured by the isopters vary in size and shape for each individual depending on:

- (1) State of light or dark adaptation of the retina - maximum zone size will be the light-adapted state. Thus, those judging colors must be light-adapted.

~~CONFIDENTIAL~~

CONFIDENTIAL

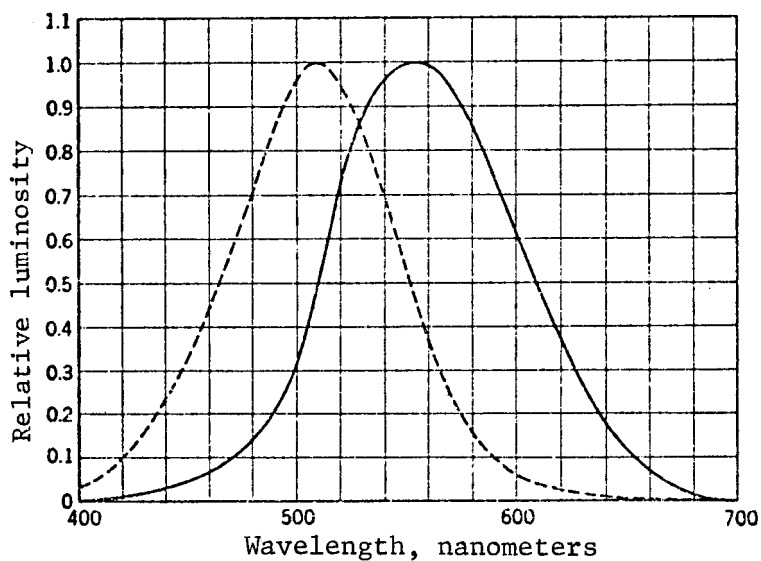

FIGURE 2.6 PHOTOPIC LUMINOSITY FUNCTION (solid line). Scotopic curve is included for comparison. From Judd, D. B., Color in Business Science and Industry, New York: John Wiley & Sons, Inc., 1952, Fig. 2, p 9.

CONFIDENTIAL

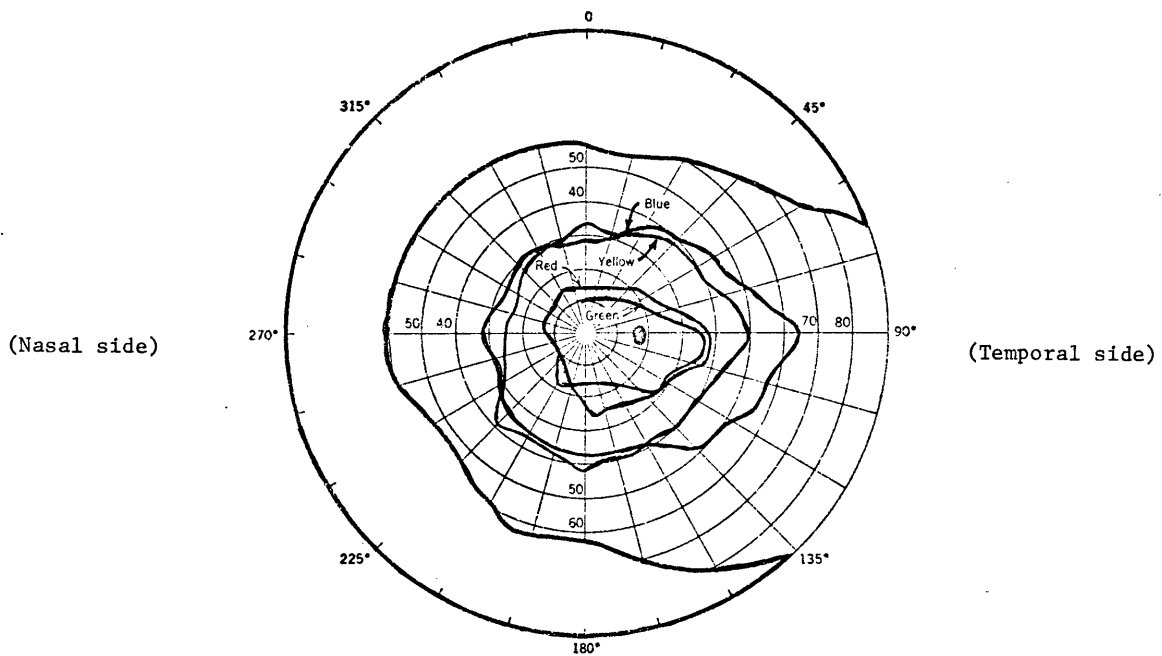

FIGURE 2.7 THE GEOMETRIC COLOR ZONES OF THE EYE.
(Committee on Colorimetry, 1953).

NOTE: The concentric circles represent the number of degrees outward (i.e., eccentricity) and the radial lines represent the direction of this outwardness (the meridians), also measured in degrees.

CONFIDENTIAL

15

CONFIDENTIAL

NPIC/R-03/72

CONFIDENTIAL

- (2) Light intensity - zone sizes will increase with light-source intensity as long as the source is below discomfort glare levels. Thus, light levels should be relatively high for viewing color imagery or prints.

As can be seen in Figure 2.7, color perception changes as the point of stimulation increases in angular eccentricity from the fovea. The hue usually changes. However, with some wavelengths (known as the stable or INVARIABLE HUES) there is a loss in saturation. There are four such hues and Zoethout (1947) records them as being 574, 495, and 471 nanometers, and a nonspectral purplish-red.

The foregoing means that precise color interpretation (matching, identifying, discrimination, etc.) must be done with central vision. However, our eyes are continually moving and, consequently, some color sensitivity is needed in the peripheral area immediately surrounding the central retina.

Further, peripheral vision is important to the interpreter during scanning. Clearly from the above data, certain colors will be more conspicuous in peripheral vision than others. It would appear that, if lightness and saturation were comparable, predominantly green colors would be the least conspicuous in peripheral vision.

2.3 COLOR PERCEPTUAL PHENOMENA

In viewing a color print or transparency, one may not perceive colors accurately. This is due to a number of perceptual phenomena related to color. Interpreters and others at the Center, dealing with color imagery, should realize the existence of the phenomena, so that some compensations can be made. How serious the effects of these phenomena will be on specific tasks is very difficult to determine without further experimentation and study. These phenomena will most likely occur, but may not seriously affect the work of an individual.

2.3.1 Area Effect

Variations in the retinal area covered by a colored object can cause a change in the perceived color. This is called an "area effect". In general, as the area of an object increases from 0 to about 20 degrees

CONFIDENTIAL

CONFIDENTIAL

on the retina, the saturation and brightness of its color increases, then with further increases in area it becomes progressively less saturated (Burnham, et al. 1963). Thus, large objects on an image which are in fact the same color as smaller ones may appear more or less saturated.

2.3.2 Simultaneous Contrast and Edge Effects

Simultaneous color contrast involves an unrealistic perception of a color due to the influence of a nearby or surrounding color (called the "inducing" color or field). For example, in Figure 2.8, the inner areas of the two squares are printed with the same ink, but they appear different in lightness, due to the different surrounding fields. The same phenomenon occurring with shades of gray (see Figure 2.9), is more properly known as Brightness Contrast. How colors affect one another is very complex, since hue, saturation, and brightness may all be involved. In general, the eye tends to accentuate the differences between colors. If, for example, two colors (or two groups) differ only in brightness, the difference appears exaggerated, i.e., the brighter of the two will appear brighter than in reality and the darker will appear darker. The same holds true for saturation differences when the hues are nearly the same. Hues affect one another in complex ways, but, in general, adjacent hues appear more different in hue than if viewed separately. If the two hues are nearly COMPLEMENTARY they will generally appear more saturated.

These color contrast effects are most prominent when:

- (1) The inducing field is large and the induced area is small
- (2) The inducing field is adjacent to or surrounds the induced area (maximum effect is at the edge of adjacent fields)
- (3) The inducing field is highly saturated
- (4) The brightness contrast is either absent or reduced.

The effects are reduced by:

- (1) The presence of well-defined borders
- (2) The presence of texture
- (3) The recognition of the induced area as a known object.

CONFIDENTIAL

CONFIDENTIAL

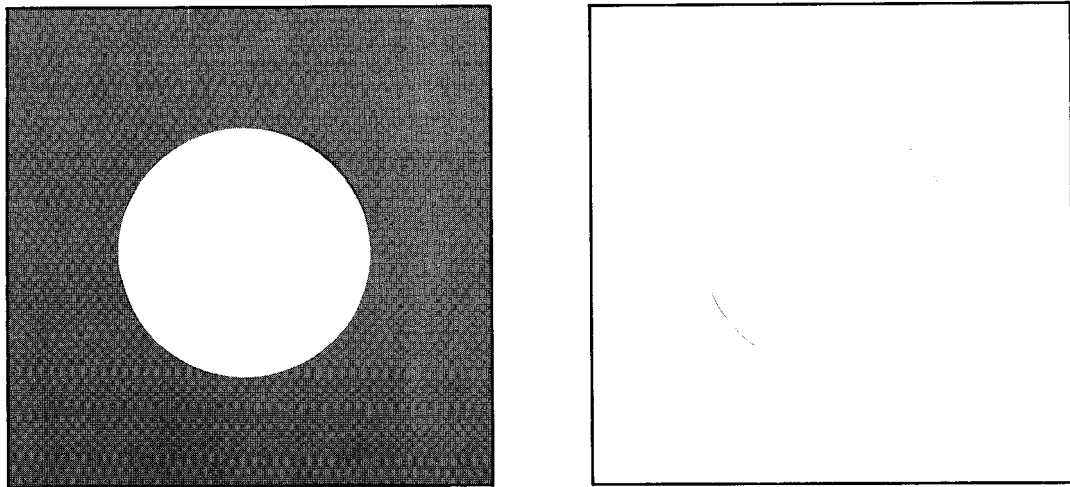

FIGURE 2.8 SIMULTANEOUS COLOR CONTRAST

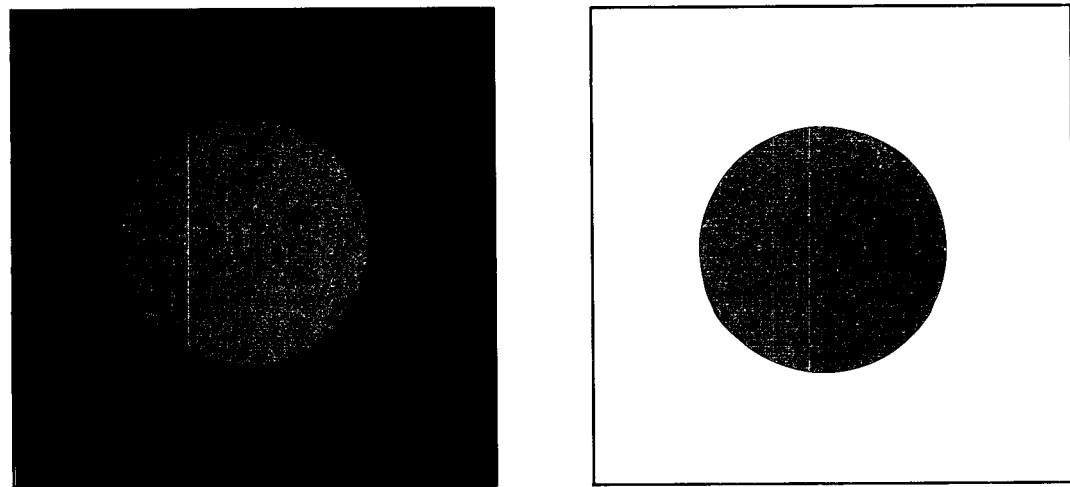

FIGURE 2.9 BRIGHTNESS CONTRAST

CONFIDENTIAL

CONFIDENTIAL

To eliminate these effects, when it is necessary to determine the precise color of an area embedded in other colors, that area should be brightly illuminated with a standard white light and viewed through an aperture in a neutral gray background. A reference color, if used, would need the same background and illumination.

Another important relationship is that sharp contours or edges (as in a well-focused image) increase the apparent saturation and brightness of the colors. Fuzzy edges (as in out-of-focus images) tend to reduce apparent saturation and brightness. These phenomena are known as edge effects.

2.3.3 Spreading Effects

Burnham, et al. (1963) notes that with certain "complicated" object situations, made up of patterns of small, spatially close areas, colors are unrealistically perceived in ways contrary to the principles of Simultaneous Color Contrast. These perceptual phenomena are known as Spreading Effects or as Assimilation where adjacent colors appear more alike than different, as if one color is "spreading" onto the other. For example, areas surrounded by black lines appear darker than when not surrounded, or when surrounded by white lines.

2.3.4 After Images

Exposure of the retina to any visual scene or stimulus (colored or non-colored) is followed by effects known as AFTER IMAGES. After images are visual responses that occur after direct visual stimulation and appear as the preceding "true" visual experience decays, i.e., it is a continuance of the visual scene, but without continuing stimulus. After images are called positive if the colors or shades of gray duplicate the preceding visual experience, and negative if the colors or shades of gray are COMPLEMENTS of the preceding visual experience.

The classic demonstration of a negative after image is to view an isolated color picture of an object for a prolonged period of time under good lighting conditions, and then suddenly change the gaze to a well-lit, untextured white surface. What appears is a fairly clear and well-defined apparition-like image in the shape of the original object, but with reversed luminosity and chromaticity, i.e., points in the after image that are now bright have been dark and vice versa, and the colors are complementary. The duration of the phenomenon is variable and may last for up to two minutes.

CONFIDENTIAL

CONFIDENTIAL

One of the problems with an after image is that, while decaying, it will usually follow the direction of gaze, being superimposed on and altering the detail, texture and color of the scene currently being viewed. The resultant color is an approximate mix of the color of the real images currently being fixated and the color of the superimposed after-image. Thus, if an interpreter stared at a colored target for a period of time and then changed his gaze to another scene, the after image would be superimposed on the next scene and interferes with its perception. Fortunately, after-image decay is rapid and the problem is seldom of any consequence.

It is important, however, to minimize the consequences of after images. Ideally, any viewing should be done under good ambient lighting conditions, prolonged staring should be minimized, and potential glare sources in the peripheral field-of-view shielded.

2.3.5 Color Constancy

Color constancy is a tendency to perceive colors as approximately the same colors despite varying illumination and viewing conditions. The most common example is perceiving snow white in both sunlight and shadow even though the light reflected from the two areas is quite different. Another simple example is the apple usually perceived as red whether in sunlight, skylight, or indoor illumination.

A more relevant but different example is the situation in which an interpreter reports U. S. military vehicles on color film as olive-drab, but in fact the film colors may have a blue tinge due to color imbalance. The explanation is that the interpreter "knows" the color, and the vehicles evoke a color name in his memory which then affects his perception.

These examples show that known and familiar objects can appear approximately the same known color under different levels and types of illumination and viewing conditions. To minimize the effects of color constancy when the precise color must be determined, color-reference samples should be used alongside the unknown color sample in question for immediate, simultaneous, and continuing comparison; and careful analytical attitude toward color viewing should be maintained.

Color constancy, however, is generally not a hinderance to photo-interpretation. It is an aid to detection and identification, because it provides perceptual continuity to objects and scenes.

CONFIDENTIAL

CONFIDENTIAL

2.3.6 Irradiation

Areas or objects of color, which are brighter, i.e., more intense than their surround, seem to spread or irradiate onto that surround. This is true whether the color is a light source or transparency. The phenomenon leads to a very slight enlarging of a light source or area in a viewed scene. Conversely, a dark object embedded in a bright surround will appear to contract or be smaller.

Irradiation can be a problem in photointerpretation work since the photographic density on different exposures of the same scene can vary and result in one scene being brighter than the others. Targets or areas may appear slightly larger on the brighter exposure.

2.3.6.1 Explanation of Irradiation

First, irradiation is due to the focusing position of the eye with respect to the visual spectrum. In white light, the eye is usually focused for the midpoint of the spectrum, represented by yellow, making the ends of the spectrum (blue and red) slightly blurred.

This blur is interpreted as a spread. Thus, in white light, with normal focus for yellow, the observer will see more spread in blue and red than in yellow. In some instances, e.g., for the near-sighted, the focus is not for yellow, but tends toward red, changing the amount of blue (or spreading) for the different colors. Here, the spreading in the blue is greater than the normal spread when focusing in the yellow. This effect, as in chromasteropsis (see Section 2.4.3) is a result of the lateral chromatic aberration of the eye.

Second, spreading is due to what is known as a Mach band phenomenon. Figure 2.10 is a graph of the emittance or reflectance of light from two objects (A and B) at their borders with a surround of darker luminosity. The left side of the abscissa of both A and B represent a base line, i.e., minimal light from a dark object where the right side represents the higher light output from a more luminous area. This could also be taken to be a more luminous object against a darker surround. The true physical transition represented by the vertical line in both cases does not apply to the luminosity distribution when the base line is spread out. Here, the slope of that spread is representative of the sharpness of the border. That slope is presented by the solid lines in both A and B. When there is a significant change in slope, the eye perceptually tends to emphasize the change, represented by the dotted line in each case. The more abrupt the change in the true slope (as in

CONFIDENTIAL

CONFIDENTIAL

REF ID: A66072

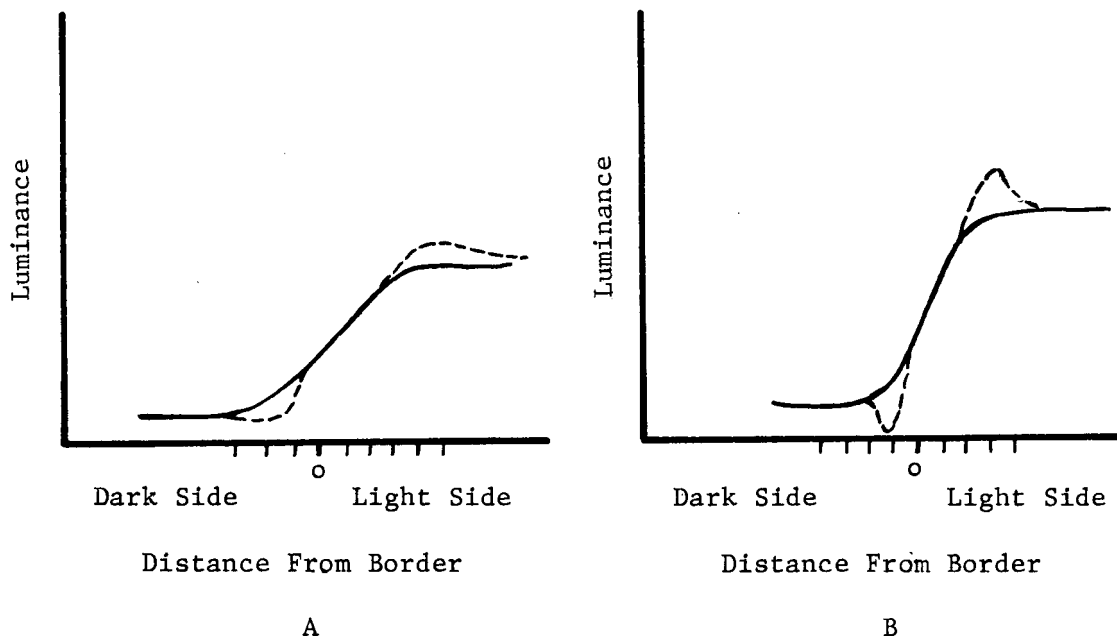

FIGURE 2.10 ILLUSTRATION OF THE PHENOMENON OF MACH BANDS
 (The ordinate in both A and B represents luminance, and the abscissa is distance to the left and right of the zero point representing as closely as possible the actual physical boundary of the border. The solid lines are the true luminous distribution, and the dotted lines represent the perceived luminous distribution, which differs from true at the change in slope. The physical appearance of this difference is called the Mach Band.)

CONFIDENTIAL

B), the more noticeable is the perceptually added emphasis which makes sharp borders appear to be sharper, and fuzzy borders fuzzier.

The two lines or bands of emphasis (two for every border) in terms of an image are seen as two "halos" (Mach bands), one dark and the other light, completely surrounding the border (and hence any object) with the dark being on the dark side of the distribution and the light being on the light side. In reality, the bands are often extremely difficult to see.

When an observer is asked to judge size, or the position of a border, he does not indicate the midpoint between the bands--corresponding to the true physical transition point. Instead, he tends to make a selection closer to the dark band. In this way, dark objects shrink and bright objects expand.

2.3.6.2 Additional Complications of Mach Bands for Photointerpretation

Color seems to have an effect on the appearance of Mach bands. However, the effect is due to brightness differences rather than chromatic differences. If two colors with both differences in luminosity and border sharpness are placed side by side, careful observation discloses, in place of the expected bright clear border, a bright line or band of the brighter color on its side of the boundary line. A similar effect will be seen with the darker color on the darker side.

The perception of these bands differs markedly under microscopic and macroscopic illumination according to Charman and Watrasiewicz (1964). Instead of a simple pair, under microscopic examination, they find a multiple band structure with at least one bright and two dark bands on the dark side, and a bright band on the high-intensity side. The bands become more pronounced as the condenser-lens aperture is cut down in size. They further note that this subjective enhancement may aid in detection and recognition of small detail. Unfortunately, it will increase the variation in accuracy of size measurement, and there is a possibility that the subjective fringes will be mistaken for fine detail surrounding larger objects.

Clearly, the presence of color and the variation in the Mach-band effect under microscopic examination, create additional complications for consistency of results in photointerpretation and mensuration.

CONFIDENTIAL

MFC/R-03/72

2.3.7 Adaptation

Adaptation is the process by which the eye makes the necessary adjustments in its photoreceptive system to correctly and continuously perceive objects or scenes under changing light characteristics. Adjusting from a dark to a more lighted environment is called LIGHT ADAPTATION, and the reverse is called DARK ADAPTATION. In most instances, light adaptation is adequate within a minute, particularly if the criterion is not overly demanding. A slightly better level for working purposes is achieved in 2-3 minutes with a very slight additional improvement between 10 and 15 minutes.

Starting from a daylight environment, the initial stages of dark adaptation are also very fast. It is reduced about a log level, e.g., from 1000 to 100 millilamberts, in a few seconds. After that, depending on the individual, it can be another 5-10 minutes until the PHOTOPIC visual system is adapted out and the SCOTOPIC takes over at about 0.1 millilambert. Darkroom conditions using safelight illumination are still in the low photopic range (not in the scotopic range, as might be expected), having a range of between 0.5 and 1.5 millilamberts. When using some extremely sensitive materials, darkroom conditions may have to go even lower, which would then be into the scotopic region of human vision. The eye can continue to dark adapt down into this region, but to reach a "zero" level can often take over an hour.

Recognition of color is functional only at luminances in excess of 0.1 millilambert. It will be optimal at between 10 and 100 millilamberts if it can be assumed that the observer has a 2-millimeter pupil size.

CHROMATIC or COLOR ADAPTATION is the ability of the eye to adjust its spectral sensitivity. Although the mechanism of color adaptation is unknown, it is involuntary and is a part of the process of light and dark adaptation. Thus, as the light in the visual scene gets dimmer, color gradually disappears, changing the world into a series of grays. As the light is increased, a brightness is reached at which the spectral sensitivity of the retina can optimally perceive colors. Failure to allow adequate time for light and dark adaptation to occur can lead to false color perceptions.

The important aspect of color adaptation is adaptation to a single color. If the eyes fixate on a single color (such as a target on color imagery) for a few seconds, the retina will adapt to the color, i.e., become less sensitive to it. When the eyes fixate on another color (another target) that color is not seen correctly. However, in a few seconds the retina will adapt to the new color. When viewing complex color scenes, however, this problem may not occur, since there are continual eye movements.

CONFIDENTIAL

CONFIDENTIAL

For critical color judgements and discriminations, the eyes must be allowed to adjust to each new situation before judgements or decisions are made, and abrupt changes in illumination must be avoided.

2.4 DEPTH PERCEPTION AND COLOR

One of the keystones upon which the art and science of photo-interpretation has been built is the ability to recognize and measure depth, height, or distance on film. This complex ability is based on many cues. Such cues are well-known and apply to black and white as well as color film. At times, the addition of color may vary the effect of the cue, even to the extent of altering the total perception. When viewing imagery and trying to form a judgment as to height (or depth), one is usually unaware of the cues being used i.e., they operate at a subconscious level.

2.4.1 Perceptual Cues of Depth

Cues are of two types, one-eyed or MONOCULAR and two-eyed or BINOCULAR. There are more monocular cues and they generally apply at greater viewing distances than do the binocular cues. Monocular cues are available when using both eyes; binocular cues vanish when only one eye is used. In photointerpretation of photographs in matched stereoscopic pairs (each picture of the pair taken from a different location in space), the binocular cue of stereopsis (see below) can become the single most-powerful cue to depth perception.

2.4.1.1 Monocular Cues

The important monocular cues are:

- (1) Relative Size - The detection of distance (or depth) depends on the size of the image formed on the retina of the eye: objects with larger images, other aspects being equal, appear to be closer.
- (2) Interposition - Overlapping objects are interpreted as being nearer than the overlapped objects.

CONFIDENTIAL

CONFIDENTIAL

REF ID: A66037

- (3) Linear Perspective - The perception of distance due to the smaller angular size that objects seem to have when they are distant as compared to when those same objects are near, i.e., closer to the observer, and provided that there is an opportunity for simultaneous comparison in the one scene. As a practical matter, the objects may be different, needing only to be similar in real size. The usual example of this phenomenon is of something parallel (the same size) appearing to converge in the distance, e.g., railroad tracks or telephone poles.
- (4) Aerial Perspective - The failure to discriminate the surface details of an object means that the object is too far away to be seen clearly. As more and more details are lost, the farther away the object appears, providing other objects in the scene are clear.

2.4.1.2 Binocular Cues

The important binocular cues are:

- (1) Convergence - At close working distances, awareness that the eyes are turned in rather than parallel is interpreted as the relative nearness of an object.
- (2) Stereopsis - The two eyes see the same object from a slightly different aspect, which means that the brain must fuse the two views into a single image. The image difference due to having different points of view is known as retinal disparity and is illustrated in Figure 2.11 when imagery appears closer to the observer, note that the center portions are pointing inward. The brain interprets the inward portion as being closer to the viewer. When imagery is receding from the observer, note that the center portions are pointing outward. The brain interprets the outward portion as being farther away from the viewer. Thus views A together with B, or D together with E can also be thought of as stereo pairs of C.

CONFIDENTIAL

CONFIDENTIAL

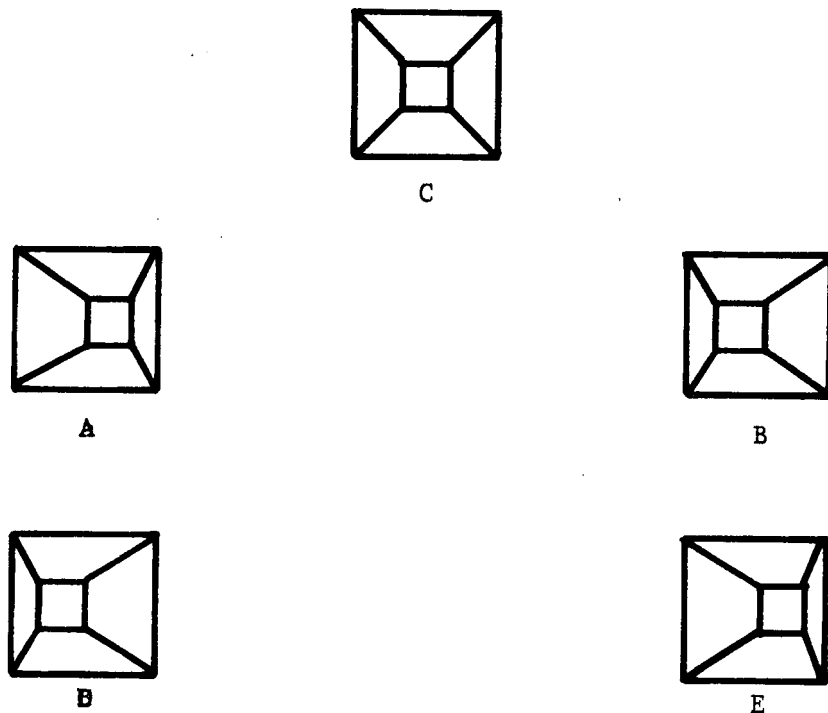

FIGURE 2.11 ILLUSTRATION OF DEPTH PERCEPTION AND RETINAL DISPARITY

In this diagram, C could be interpreted as either a view of a sawed-off pyramid pointing toward the observer or the inside of a box. If this were a real three dimensional object or specially prepared stereo pair (anaglyphs) representing the slightly different view as seen from the different points in space occupied by the two eyes; the left eye, in the first instance would be processing image "A" while the right would be occupied with image "B". In the second instance, where the total perception was that of the interior of a box, the left eye would be seeing image "D" and the right, image "E".

CONFIDENTIAL

CONFIDENTIAL

REF ID: A66075

2.4.2 Effect of Color on Cues

In general, color does not greatly affect depth perception cues. However, some colors themselves appear closer than others. This has been called a psychological awareness of depth. There is no agreement as to which colors appear closer than others (although red has been stated most often). Which color appears closer probably varies among people and may also vary according to luminance. This is an illusory, i.e., misleading, addition of depth to the color image. In a binocular mode where one expects depth from stereopsis, two problems may occur: (1) depths may be exaggerated, and (2) objects or areas may appear to have depth solely due to their color.

2.4.3 Chromastereopsis

Chromastereopsis is a binocular illusion of depth, due to color, different than the psychological awareness mentioned above. It can occur when viewing two or more small, highly saturated colored areas or targets against a homogeneous background, where the targets are of widely separated wavelengths but close together in space. On complex imagery where textured backgrounds are most common the illusion may not occur. However, on imagery where backgrounds are homogeneous, e.g., water, desert, or on high-altitude photography where the background details and colors blend together forming near homogeneity, the illusion is more likely to occur.

Observers usually see reds as closer, and blues and greens farther away. However, some people see the reverse, and reversal of direction can occur during observation.

This illusion is quite complex and is believed to be caused by the combined effects of the color dispersion characteristics of the eye's optical system, as well as the fact that the foveas and pupils are not centered on the optical axis of the eye.

The most practical solutions to this illusion are alertness on the part of the interpreter and inspection of a suspected illusion by another interpreter.

CONFIDENTIAL

CONFIDENTIAL

2.4.4 The Pulfrich Phenomenon

The Pulfrich phenomenon is an illusion of depth that can occur with paired stereoscopic images either in black and white or color, when one of the pair is brighter than the other due to density differences, or due to a split light-table where one of the pair is given more rear lighting than the other side. In this phenomenon, the darker of the two retinal images is perceived as farther away. Thus, one of the two views is perceived as farther away than the other, and depth may be exaggerated or stretched causing interpretation and measurement errors. Further research is required on the Pulfrich phenomenon to determine the effects of the stereoscopic depth illusion in color photographs. This is particularly so because the Center is using split light-tables where one eye can obtain more illumination than the other.

2.5 COLOR CAPABILITIES AND SKILLS

With the advent of color imagery at the Center, it is important to understand the color capabilities, skills, and limitations of the average individual. Certainly, anyone at the Center who will be working with color imagery (and making judgments and decisions about the imagery) must possess good color skills to fully and accurately exploit the imagery. The most important skill is color discrimination, i.e., being able to perceive differences between colors that are very similar. Also, being able to accurately identify the name or designation of a color, and communicating that color name will be a critical skill throughout the operational units of the Center. The capability of average individuals in these skills is discussed below.

2.5.1 Color Discrimination

Color discrimination is defined as the ability to report (or respond to) differences among colors, i.e., differences in hue, saturation, or lightness. This ability is very important in photointerpretation of color imagery and mensuration. Color differences are the primary cues that may lend an advantage to color imagery, particularly for target and change detection, and for determining edges.

Since colors can vary in hue, saturation, and lightness, normal discrimination ability can be expressed in terms of these dimensions as well as total color-discrimination ability. In the following discussion, it must be remembered that discrimination ability varies with both the

CONFIDENTIAL

CONFIDENTIAL

type and the level of the illumination, and with the size of the color field (degrades rapidly below 1/2 to 1 degree). It also varies among people.

Discrimination of lightness differences at everyday light levels (1 to 1000 foot lamberts) is approximately constant over the spectrum of 400 to 700 nanometers (Burnham, et al., 1963). At lower light levels this is not true, but low light levels should not be used with color imagery. Just-perceptible-lightness differences are generally less than .05.

Discrimination of saturation differences may be expressed as the number of discernible steps from neutral gray. Note in Figure 2.12, that the least number of steps occur around 570 nanometers (yellow-green), whereas larger numbers of steps are discernible at the extremes of the spectrum (reds, blues, and some greens).

Discrimination of wavelength differences can be expressed as the number of nanometers of wavelength that must be added to or subtracted from a given wavelength to allow the observer to perceive a difference or change. Figure 2.13 shows that over most of the spectrum 1 to 2 nanometers are required, but at the extremes of the spectrum 2 to 6 nanometers are required.

Discrimination among all colors (including hue, lightness, and saturation) can be expressed in terms of the number of different colors that can be seen by the normal eye. Theoretical estimates range in the millions. Practically no existing displays (including color films) record all these colors. The normal human visual system's capability to discriminate among color exceeds the capacity of existing displays to present them.

2.5.2 Color Memory

Although our visual system can discriminate among millions of colors, our memory of colors is very unreliable. Color memory may be defined as an observer's judgment as to the color of an object without the use of a physical reference standard, e.g., Munsell Color Chips.

Until an individual has had some experience with an object or scene, color memory is unreliable, i.e., color matches or color naming will be highly variable with or without the object being present. However, once experience has been gained, the factor which is dominant in the object's color will tend to be exaggerated in memory recall. For example, bright objects will tend to be remembered as brighter than they actually

CONFIDENTIAL

CONFIDENTIAL

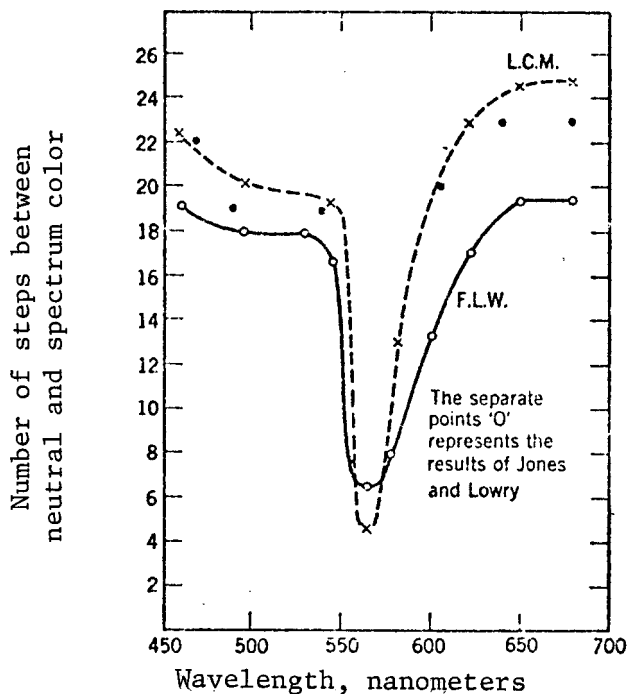

FIGURE 2.12 NUMBER OF JUST-PERCEPTIBLE STEPS BETWEEN NEUTRAL (color temperature 4800 K) AND THE SPECTRUM COLORS. (Wright, 1947).

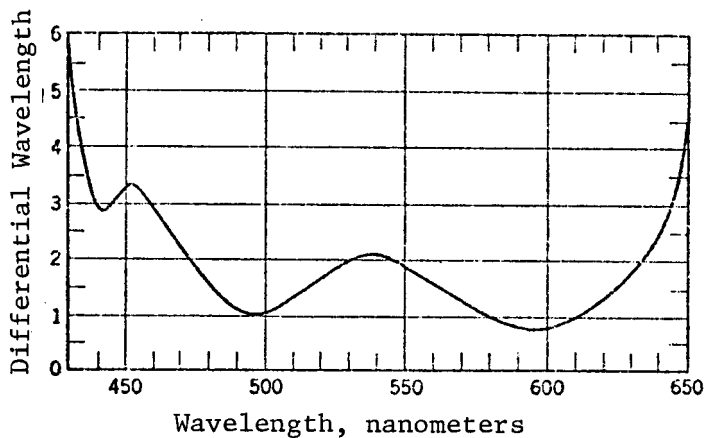

FIGURE 2.13 DIFFERENTIAL COLOR SENSITIVITY. From LeGrand, (translated by R. W. G. Hunt, J. W. T. Walsh, and F. R. W. Hunt, New York: John Wiley and Sons, Inc., 1967).

CONFIDENTIAL

CONFIDENTIAL

were and dark objects as darker. Saturations will be increased, e.g., a pink will be more red on memory recall. Hue shifts will also emphasize a predominating color. In most instances, perceptions will be consistent with what the individual observer has found to be pleasing for a given object, as well as what the object might normally be expected to look like. Over time, color-memory reliability decreases, but with training and practice, reliability can be increased (Hanes and Rhoades, 1959).

2.5.3 Color Naming

Color naming, or identification, is identifying a color without the availability of a closely matching reference color. This ability is mostly dependent upon color memory and, as a result, limits the number of reliable identifiable colors. If a memory scale is learned, as many as 14-15 hues can be named. Otherwise, it might be as few as 10 (Halsey and Chapanis, 1951; Hanes and Rhoades, 1959). If brightness and saturation are allowed to vary along with hue, the number of colors named can be increased. It is possible to train people to reliably name colors (up to 40-50 perhaps), but training time is extensive and periodic practice is required (Hanes and Rhoades, 1959). Such an ability is rarely needed, however, since references are available with colors already named, e.g., ISCC-NBS color system.

2.5.4 Color Matching (see also 3.4 COLORIMETRY)

The ability to match colors is one of the most demanding of the color abilities. Essentially, it requires the observer to find a perceptually perfect or near-perfect color match from a set of colors, to match a test color. At the Center, color matches are most likely to be limited to positive transparencies, glossy prints, and matte proofs (or paper). Usually, the purpose of matching is to determine if two colors are the same, or to determine the name or reference number of a color through colored reference samples.

For optimal and precise color matching, there are several requirements:

- (1) The illuminant should be the same (both type and intensity level) for both color samples. The use of different illuminants or intensity levels causes colors to be perceived differently and, thus, cause matching errors.

CONFIDENTIAL

~~CONFIDENTIAL~~

- (2) The colors being matched should be on the same (or nearly the same) type of material. The surface of a color affects the perception of that color. A matte red surface looks different than a glossy red surface, and both look different from a red area on a transparency. Yet all these reds could be identical.
- (3) The size of the observer's field-of-view for both colors should be the same. Two apertures in a neutral gray field, one for each color, would solve this requirement.
- (4) The viewing angle should be the same for both colors.
- (5) The two colors should be surrounded by a neutral gray field (see 2.3.2 Simultaneous Contrast and Edge Effects, and 2.3.3 Spreading Effects).
- (6) The observer must, of course, have normal color vision. However, even within the normal range there is sufficient variation to cause differences and disagreements among "normal" individuals. Thus, perfect color matches are probably impossible, and it is "estimated that a perfect match by a perfect 'average' observer would probably be unsatisfactory for something like 90 percent of all observers" (Evans, 1948, p 196). Individuals whose color vision is defective, e.g., dichromats (red-green or yellow-blue color weak) and monochromats (almost totally color blind) would make matches even more unacceptable to normal observers. However, observers with defective color vision may be satisfied with matches made by a normal observer, because they cannot detect differences. Yet, unless that match is perfect, it may be made unacceptable to other normal observers. Thus, two observers may agree on a match, yet both may have normal color vision, or one may be color defective. The significance of this problem is that all individuals involved should be color-vision tested, and disagreements among normal observers can be expected.

~~CONFIDENTIAL~~

CONFIDENTIAL

How stringent these requirements must be followed, depends on the precision required in matching colors. In addition, with training and practice, observers may be able to adapt to variations in these requirements, e.g., texture differences or differences in intensity levels.

2.6 INDIVIDUAL DIFFERENCES IN COLOR PERCEPTION

Under conditions of adequate lighting, virtually everyone can discriminate colors to some degree. Those extremely rare individuals that cannot do so (although they can still detect light and brightness differences) are truly color blind. A large group of people (often up to 10 percent of any population sample) are color weak, i.e., they will see colors, but identify or match some of them differently, depending on their individual defect. Various possible defects are described in 2.6.1.1.

All people may be classified as either color normals or color defectives. Very few people, however, have this information about themselves, and most people believe they have normal color vision. An adequate description or classification can be made only on the basis of a carefully performed, objective test. Theoretically, a test can be made fine enough to show differences between color normals. However, such differences would be insignificant in terms of the practicalities of most color-vision problems, except perhaps obtaining agreements on color matching (see 2.5.4 Color Matching). Therefore, classification is usually limited to normals and the various types of defectives. Quantification of the defect is usually a pass-fail type of labelling. Further subdividing can be done, although in the context of the practical problem, it is troublesome and expensive, particularly when it is considered that the usual classification problem is simply separating defective from normals.

2.6.1 Defective Color Vision

Although most people have normal color vision, a significant minority, ranging from 8 to 10 percent of the population (less than 10% of these are female), have one of several color defective conditions. Awareness of and knowledge of some of the details of the phenomenon are important to anyone involved with color, primarily because of the reliance placed on the detection of small color differences.

Not all color defectives are color blind. Also, there are a large variety of types and many degrees of severity among color defectives. Basically, there are two problems with color defectives: (1) a failure to

CONFIDENTIAL

~~CONFIDENTIAL~~

detect normal color differences, and (2) confusion in communicating colors to other people. Obviously, these problems are critical at the Center.

2.6.1.1 Types of Color Vision Defects

A person with normal color vision is called a TRICHROMAT, because he can match any pure spectral color with a mixture of three primary colors (red, blue, and green).^{*} His description can be found in Sections 2.2 Color Sensitivity of the Visual System, and 2.5 Color Capabilities and Skills. However, not all trichromats have the same sensitivity to color, and thus, there is a range of normal color vision. Outside this normal range, fall the individuals known as color defectives. The three relevant categories of color defectives are MONOCHROMATS, ANOMALOUS TRICHROMATS, and DICHROMATS. Monochromats are totally color blind and see only brightness differences. Usually there is also a reduction in visual acuity and other eye problems.

Anomalous trichromats resemble the normal trichromats in that they use the three primary colors (red, blue, and green) to match colors and they can perceive all colors. However, the amounts of the primary colors needed to make the match will differ from that of the normal trichromat. The two most common of the anomalous trichromats are known as DEUTERANOMALS (4.9 percent of males, 0.39 percent of females) and PROTANOMALS (1.0 percent of males, 0.02 percent of females). The former needs more green to make his matches agree with normals. The latter usually requires more red. Both have difficulty in making distinctions between reds and greens.

With good lighting and adaptation, anomalous trichromats seem to see the same colors as normal individuals, but they differ in color matches and, perhaps, color naming. How important this defect is to color-image interpretation will depend on how critical color identification becomes to the interpretation task. The performance of any Center interpreters with this type of defect who will be judging, matching, and naming colors will be somewhat affected.

Dichromats are people that are partially color blind. The two principal types are PROTANOPEs (1.0 percent of males, 0.02 percent of females), and DEUTERANOPEs (1.1 percent of males, 0.01 percent of females).

* Theoretically any color can be matched by a proportional mixture of red, green, and blue. All individuals with normal color vision would mix these in the same approximate way to match a particular color. Anyone who has marked differences in these proportions is color defective. For example, if an individual uses more green than usual for a color, his eyes must be weak in green.

~~CONFIDENTIAL~~

CONFIDENTIAL

The former is less sensitive, or "blind" to the extreme red end of the spectrum and see reds and bluish-greens as gray. The latter have a similar difficulty (although usually not as severe) with greens, and see greens and bluish-reds as gray. Their common problem, along with the anomalous trichromats, is the detection of red-green differences.

The TRITANOPES (0.002 percent of males, 0.001 percent of females) are individuals that are weak in blues and see purplish-blue and greenish-yellows as gray. For reasonably large areas of sample colors, this type of defect is much rarer than either protanopia or deuteranopia. However, for central (foveal) fixation at extremely small viewing angles (less than 1/2 degree), it is considered universal and called SMALL-FIELD TRITANOPIA. Thus, anyone staring at a very small area will experience a loss of blue. This is not ordinarily noticed, since the fixation of the eye continually wanders.

The dichromat will often fail to detect a difference between samples matched by normal trichromats. In fact, he will usually agree with such matches. Also, he will have difficulty discriminating between certain colors. Clearly, for the interpretation of color imagery (detection of color differences) and the judging, naming, and matching of colors, dichromats could have difficulties, and may cause errors.

2.6.1.2 Congenital versus Acquired Color-Vision Defects

Most authorities usually think of color defective vision as a condition that began before birth and will continue throughout one's life-time, with no hope of a cure. These are congenital color-vision defects. So-called training programs for correction can do little more than teach an increased reliance on brightness perception and memorization of some test patterns used in examination of color vision.

Various acquired forms of color blindness, fortunately, do not occur too frequently. They are usually symptoms of conditions affecting the eyes, i.e., the defect in color vision is secondary to some other main effect elsewhere in the body. In some instances, acquired damage is permanent, while in others, it can be cured.

2.6.1.3 The Effects of Age on Color Perception

Color perception begins to alter around the age of 25 to 30 years, but the change is very slow and does not become pronounced until after the age of 60. The actual change is a slight attenuation at the

CONFIDENTIAL

CONFIDENTIAL

lower end of the spectrum (blue region) due to scattering resulting from an extremely slow progressive sclerosing (hardening) of the lens of the eye. The amount of this effect and the age of onset are extremely variable. To the individual, the change is a visual world which is slightly, but continually becoming progressively more yellow.

2.6.2 Color-Vision Tests

Some color-vision tests may have immediate application to the Center. While these tests seem to be the most appropriate, they are a substitute for a test or series of tests that should be specially developed for the Center. The tests discussed may be optimal as a starting program, but their effectiveness cannot be evaluated until (1) studies on how color affects the task of Center personnel, and (2) validation studies on work performance of personnel that have taken the tests, have been completed. An additional possible shortcoming of the tests is that they all emphasize reflected light, whereas photointerpreters, photogrammetrists and others, use transmitted light for viewing color imagery.

2.6.2.1 Pseudoisochromatic Chart Tests (PIC)

These include Stilling, Ishihara, Dvorine, and American Optical's Hardy-Rand-Rittler, as well as several other less readily available versions. These are test charts, usually viewed by reflected light (although some occupational vision desk-top tester devices use transilluminated targets). The purpose is to screen out and, to a certain extent, classify color defects. PIC tests are not used for evaluation of higher color skills such as matching. No one test has been found consistently best (Lewis and Ashby, 1967), although the Ishihara and American Optical's Hardy-Rand-Rittler are most popular.

Test plates are constructed of a large variety of sizes of dots, or circles, the value, hue, chroma, and areas of which are arranged so that the viewer or testee will see (from a normal reading distance of 14 in.) a figure, letter, or shape if he is a normal trichromat. However, the color defective will see only a confusion of dots. In other plates, the situation is exactly reversed. A third type of plate is devised so that the color normal will see one type of figure and the color defective will see another. A large variety of plates is available so that some classification of color defectives is possible.

CONFIDENTIAL

CONFIDENTIAL

2.6.2.2 The Farnsworth-Munsell 100-Hue Test (FMT)

This is a color-discrimination test that divides people into three groups: low, normal, and superior color aptitude, on the basis of their color-discrimination ability. It will also detect, screen out, and approximately classify all types of color defectives.

The apparatus comprises four wooden panels or racks and 85 round plastic caps of color samples (with black borders) equally spaced in Munsell hue and of about equal value and chroma. The task for the testee is to arrange all of the discs in sequence according to his perception of their hue. He is given two minutes to complete each of the four racks, although no provision is made for analysis of time in scoring. Farnsworth recommended a minimum of two tests per individual, and usually took the average of the two as the score (Farnsworth, 1957).

The scoring is a measure of the number and way the discs are transposed out of the correct sequence. A unique property of the test is the method of graphing the score. A specially prepared polar coordinate plot is available from the test suppliers. The circumference represents the sequence of hues represented by the 85 color samples. The radius to any point on the circumference represents the correctness of the response. The sum of all radii represent the total score, which is inversely related to color aptitude (the lower score shows high aptitude).

Thus, if all points on the plot are connected, a small tight circle would be a low score, and the testee, a good color discriminator and a normal trichromat. A large circle would be the higher score of a poor color discriminator, but a normal trichromat. Any localized projections from the circle would increase the score and indicate the colors that the testee had difficulty with, with respect to both perception and discrimination.

Thus, the test can also be used to corroborate evidence of color defects from other tests.

2.6.2.3 The Inter-Society Color Council Color Aptitude Test (ISCC-CAT)

This is a test of color matching of square chips seen by reflected light and takes approximately an hour to administer. It was developed to select people in industry known as "shaders" who are on production or quality

CONFIDENTIAL

control jobs, and, thus, are responsible for the color uniformity of a given product. They are expected, as part of their job qualifications, to have superior color aptitudes.

The test is made up of two identical sets of 48 chips. One set is permanently mounted on an easel, inclined at a 45 degree angle, in front of the person being tested. Of the 48, only 40 are used for scoring. The mounting arrangement is such that there are four rows, each corresponding to one of the hues (blue, red, green, and yellow), and chips within these rows are randomly arranged on the basis of saturation. The graduations in the steps are about 0.2 Munsell Chroma (saturation) steps.

The second set of 48 chips is identical to the first and randomized in a preset standardized order. The person being tested pushes out each new chip when he is ready to make a match placing it on the easel below the chip which he feels is the closest match. Only one match is possible at a time since each chip must be returned to the rear of the dispenser in order to get a new one.

The total test score is the sum of individual match scores, which in turn is a measure of the closeness of the match. Time is usually not controlled. However, if it were, standard scores under such time limitations would have to be developed.

There is no prerequisite for color normality to take this test, and some color defectives have done well because they have learned to rely on cues of brightness and color saturation for "color" discrimination. However, a color defective will usually be revealed by a relative poorer score on one of the rows of a single hue.

2.6.2.4 The Burnham-Clark-Munsell Color-Memory Test (BCMS)

This is a test of short-term color memory. Although not commercially available, Burnham (Garra and Briggs, 1970) has indicated that the experimental materials could be made available. On the basis of the analysis by Burnham, Hanes, and Bartelson (1963) it appears to be better than the only other color-memory test available, the Woods Color Aptitude test.

Procedurally, the testee looks for five seconds at one of 20 variously colored test chips mounted in a wheel and then covers it for five seconds. At this point, with only the memory of the test chip as a reference, he selects the best possible match from one of 43 comparison chips.

CONFIDENTIAL

2.6.2.5 Campimeter Test

All of the foregoing tests are measures of the color aptitude of central vision. Peripheral vision is also used, particularly during screening and scanning of imagery. Therefore, it is suggested that the color detection and discrimination properties of a photointerpreter's peripheral vision be tested. A plot of the geometric color zones of the eye (see Section 2.2.3) can be made using either a campimeter or a perimeter. The campimeter is preferable since it emphasizes the central portion of the retina where the sensitivity to color is maximum.

However, no standards are available to classify people into categories of good to poor peripheral color vision.

2.6.2.6 Explanation of Test Battery Usage

The foregoing represents a tentative battery of available tests. The first two tests would be used for initial classification. The PIC would select color defectives out of the total population and the FMT would classify the color discrimination ability of the color normals into three groups (low, normal, and superior) and substantiate PIC findings on color normality.

Finer measures of color discrimination would be obtained by the ISCC-CAT that is designed to measure small differences in superior color discriminators, and that could be used to measure changes in color ability as a result of training and/or color experience.

Furthermore, measures of color memory and peripheral color sensitivity could also be taken. These specifically could be done with the BCM color-memory test and the campimeter, although both should have further development work.

CONFIDENTIAL

~~CONFIDENTIAL~~

2.7 REFERENCES

- Bartleson, C. J., "Memory Color of Familiar Objects", *Journal of the Optical Society of America*, 50(1), pp. 73-77 (1960).
- Boynton, R. M., Schaefer, W., and Neun, M. E., "Hue Wavelength Relation Measured by Color-Naming Method for Three Retinal Locations", *Science*, 146, pp. 666-668 (1964).
- Brown, W.R.J., "The Influence of Luminance Level on Visual Sensitivity to Color Differences", *Journal of the Optical Society of America*, 41(10), pp. 684-688 (1951).
- Brown, W.R.J., "The Effect of Field Size and Chromatic Surroundings on Color Discrimination", *Journal of the Optical Society of America*, 42(11), pp. 837-844 (1952).
- Burnham, R. W., Hanes, R. M., and Bartleson, C. J., Color: A Guide to Basic Facts and Concepts, John Wiley and Sons, New York (1963).
- Cavonius, C. R., "Human Visual Acuity Measured With Colored Stimuli", Final Report, AR-65/8-Cr, Human Sciences Research Incorporated, McLean, Virginia (1965).
- Cavonius, C. R., "The Effect of Wavelength on Visual Acuity", ERF-RR-1/67/Cr, Eye Research Foundation, Bethesda, Maryland (1967), AD 646575.
- Chapanis, A., and Halsey, R. M., "Absolute Judgements of Spectrum Colors", *The Journal of Psychology*, 42, pp. 99-103 (1956).
- Charman, W. N., and Watrasiewicz, B. M., "Mach Effect Associated With Microscope Images", *Journal of the Optical Society of America*, 54(6), pp. 791-795 (1964).
- Committee on Colorimetry - Optical Society of America, The Science of Color, Thomas Y. Crowell Company, New York (1953).
- DeValois, R. L., and Jacobs, G. H., "Primate Color Vision", *Science*, 62, pp. 533-540 (1968).
- Dwyer, W. O., and Lit, A., "Effect of Luminance-Matched Wavelength on Depth Discrimination of Scotopic and Photopic Levels of Target Illumination", *Journal of the Optical Society of America*, 60(1), pp. 127 (1970).

~~CONFIDENTIAL~~

CONFIDENTIAL

- Diamond, A. L., "Simultaneous Brightness Contrast and the Pulfrich Phenomenon", Journal of the Optical Society of America, 48(12), pp. 887-890 (1968).
- Dimmick, F. L., "Methodology in Test Preparation", Journal of the Optical Society of America, 3(6), pp. 308-315 (1943).
- Emsley, H. H., Visual Optics, Hatton Press Limited, London, England (1950).
- Evans, R. M., An Introduction to Color, John Wiley and Sons, New York, New York (1948).
- Farnsworth, D., The Farnsworth-Munsell 100-Hue Test for the Examination of Color Discrimination Manual, Munsell Color Company, Baltimore, Maryland, Rev. Ed. (1957).
- Fry, G. A., Bridgeman, C. S., Ellerbrock, V. J., and Allen, M. J., "Means for Measuring and Compensating Chromastereopsis With Special Reference to the Use of the M-1 Height Finder", Report to the National Defense Research Committee (1943).
- Garra, A. A., and Briggs, S. J., "Image Interpretation - State of the Art Review", The Boeing Company, Aerospace Group, Seattle, Washington (1970).
- Graham, C. H., Vision and Visual Perception, John Wiley and Sons, New York, New York (1965).
- Halsey, R. M., "Identification of Signal Lights. I. Blue, Green, White, and Purple", Journal of the Optical Society of America, 49(1), pp. 45-56 (1959).
- Halsey, R. M., and Chapanis, A., "On the Number of Absolutely Identifiable Spectral Hues", Journal of the Optical Society of America, 41(12), pp. 1057-1058 (1951).
- Hanes, R. M., and Rhoades, M. V., "Color Identification as a Function of Extended Practice", Journal of the Optical Society of America, 49(11), pp. 1060-1064 (1959).
- Hilz, R., and Cavonius, C. R., "Wavelength Discrimination Measured With Square Wave Gratings", Journal of the Optical Society of America, 60(2), pp. 273-277 (1970).

CONFIDENTIAL

CONFIDENTIAL

- Hoffman, C. S., "Comparison of Monocular and Binocular Color Matching", Journal of the Optical Society of America, 52(1), pp. 75-80 (1962).
- Jameson, D., and Hurvick, L. M., "Perceived Color and Its Dependence on Focal, Surrounding, and Preceding Stimulus Variables", Journal of the Optical Society of America, 49(9), pp. 980-998 (1959).
- Judd, D. B., "Color Blindness and the Detection of Camouflage", Science 97, pp. 544-546 (1943).
- Judd, D. B., "Facts of Color Blindness", Journal of the Optical Society of America, 33(6), pp. 294-307 (1943).
- Judd, D. B., and Wyszecki, G., Color in Business, Science and Industry, Second Edition, John Wiley and Sons, New York (1963).
- Kishto, B. N., "The Color Stereoscopic Effect", Vision Research, 5, pp. 313-329 (1965).
- Lakowski, R., "Psychological Variables in Colour Vision Testing", Paper #52, read at the First Institute Congress on Colour, 9-13 June 1969, Stockholm, Sweden, AD 695343.
- LeGrande, Y., Light, Color and Vision, 2nd Edition, Chapman and Hall Ltd., London, England (1968).
- Lewis, M. F., and Ashby, F. K., "Diagnostic Tests of Color Defective Vision Annotated Bibliography, 1956-66", AM 67-8, Federal Aviation Administration, Office of Aviation Medicine, Washington, D. C. (1967).
- Lit, A., Dwyer, W. O., and Morandi, A. J., "Effect of Background Wavelength on Stereoscopic Acuity at Scotopic and Photopic Illumination Levels", Journal of American Academy of Optometry, 45(3), pp.195-203 (1968).
- MacAdam, D. L., "Small-Field Chromaticity Discrimination", Journal of the Optical Society of America, 49(12), pp. 1143-1146 (1959).
- MacAdam, D. L., "Visual Sensitivities to Color Differences in Daylight", Journal of the Optical Society of America, 32(5), pp. 247-274 (1942).

CONFIDENTIAL

CONFIDENTIAL

REF ID: A67207

Mockovack, W. P., and Chason, L. R., "The Effects of Sound on Color Intensity Perception", A paper delivered at the 14th Annual Human Factors Convention (1970).

Murray, Elsie, "Evaluation of Color Vision Tests", Journal of the Optical Society of America, 33(6), pp. 316-334 (1943).

Newhall, S. M., Burnham, R. W., and Clark, J. R., "Comparison of Successive With Simultaneous Color Matching", Journal of the Optical Society of America, 47(1), pp. 43-56 (1957).

Pennington, J., "The Effect of Wavelength on Stereoacuity", Journal of American Academy of Optometry, 47(4), pp. 288-294 (1970).

Ratliff, F., Mach Bands, Holden-Day, San Francisco (1965).

Ruddock, K. H., "The Effect of Age Upon Color Vision - I Response in the Receptor System of the Human Eye", Vision Research 5, pp. 37-45 (1965).

Ruddock, K. H., "The Effect of Age Upon Color Vision - II Changes With Age in Light Transmission of the Ocular Media", Vision Research, 5, pp. 47-58 (1965).

Singer, J. R., "Electronic Analog of the Human Recognition System", Journal of the Optical Society of America, 51(1), pp. 61-69 (1961).

Scolfield, F., "Color Specifications for Transparent Materials", in Symposium on Color, Spring Meeting of the American Society for Testing Materials, Washington, D. C. (1941).

Troland, L. T., Psycho-Physiology, Volume II, D. Van Nostrand, New York, New York (1930).

Vos, J. J., "Some New Aspects of Color Stereoscopia", Journal of the Optical Society of America, 50(8), pp. 785-790 (1960).

Von Bekeasy, G., "Apparent Image Rotation in Stereoscopic Vision", Perception and Psychophysics, 8(5b), pp. 343-347 (1970).

Von Helmholtz, H., Physiological Optics, trans. & ed. by J.P.C. Southall, Dover, New York (1962).

CONFIDENTIAL

CONFIDENTIAL

Wolff, E., The Anatomy of the Eye and Orbit, Third Edition, Blakiston, Philadelphia, Pennsylvania (1948).

Wright, W. D., Researches on Normal and Defective Colour Vision, C. V. Mosby, St. Louis, Missouri (1947).

Wyszecki, G. and Stiles W. S., Color Science: Concepts and Methods, Quantitative Data and Formulas, John Wiley and Sons, New York (1967).

Zoethout, W. D., Physiological Optics, The Professional Press, Inc., Chicago, Illinois (1947).

CONFIDENTIAL

CONFIDENTIAL

3.0 THE PHYSICS OF COLOR

3.1 THE PHYSICAL ASPECTS OF COLOR

"For the Rays (of light) to speak properly are not coloured. In them there is nothing else than a certain Power and Disposition to stir up a sensation of this or that colour."*

Newton recognized that color is a complex phenomenon with many different physical and psychological aspects. Figure 3.1 is one way of illustrating this psychophysical nature of color. The observer represents the psychological aspects of color. The light source and object represent those aspects of color that are characterized by mass, length, and time -- the dimensions of the physical world. Understanding this dual psychophysical nature of color is important to the reader, because these elementary concepts are the foundations for the following discussion of color, color perception, and color measurement**.

A light source converts various forms of energy, e.g., chemical, electrical, mechanical, into LIGHT, a form of energy to which the eye is visually sensitive. The propagation of light, i.e., energy, away from a source is quite analogous to the outward movement of small periodic waves from the point at which a pebble, i.e., energy source, strikes the surface of a pool of still water. The passage of light or transport of energy through space is described by what are called ELECTROMAGNETIC WAVES. The WAVELENGTH denotes the distance after which the electromagnetic wave repeats, i.e., the distance between corresponding points on adjacent waves. The eye is sensitive to only those wavelengths from slightly less than 400 nanometers to slightly greater than 700 nanometers (nanometer = 10^{-9} meters). Thus, light is a very small part of the electromagnetic spectrum illustrated in Figure 3.2.

Light sources are characterized in terms of the relative energy emitted at each wavelength. A graph showing the energy emitted by a source as a function of wavelength is a SPECTRAL ENERGY DISTRIBUTION CURVE. The curve for a typical 40-watt incandescent lamp is shown in Figure 3.3, and that for a typical 40-watt fluorescent lamp in Figure 3.4.

* Newton, OPTICKS - from Billmeyer and Saltzman (1966)

** A more detailed treatment of these topics can be found in the following texts: Evans, 1948; Wyszecki and Stiles, 1967; Billmeyer and Saltzman, 1966; Burnham, Hanes, and Bartleson, 1963; Judd and Wyszecki, 1963; Hunt, 1967.

CONFIDENTIAL

CONFIDENTIAL

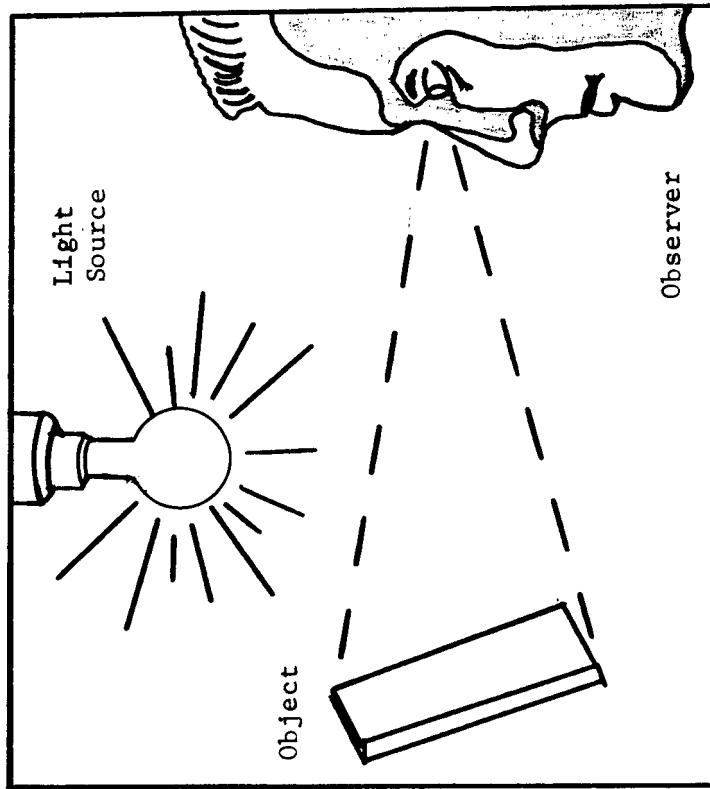

FIGURE 3.1 THE ESSENTIAL ELEMENTS OF COLOR (Billmeyer and Saltzman, 1966)

CONFIDENTIAL

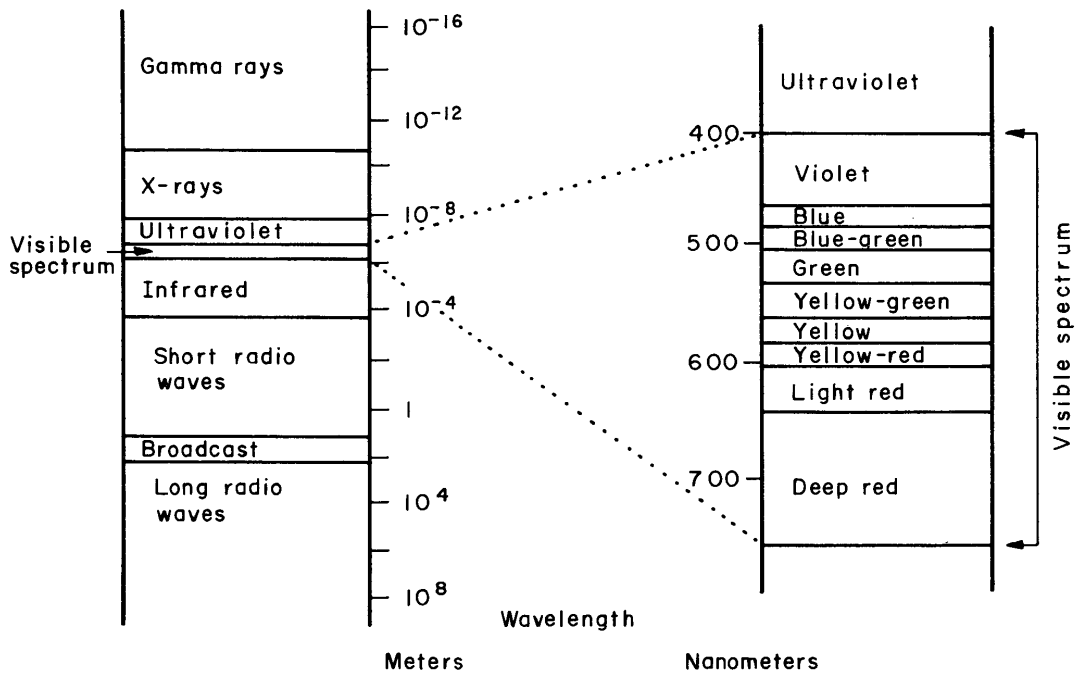

FIGURE 3.2 THE ELECTROMAGNETIC SPECTRUM

CONFIDENTIAL

CONFIDENTIAL

CONFIDENTIAL

49

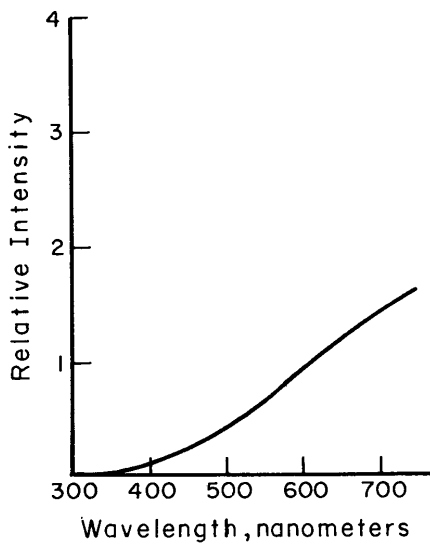

FIGURE 3.3 THE SPECTRAL ENERGY DISTRIBUTION FOR A 40-WATT INCANDESCENT LAMP

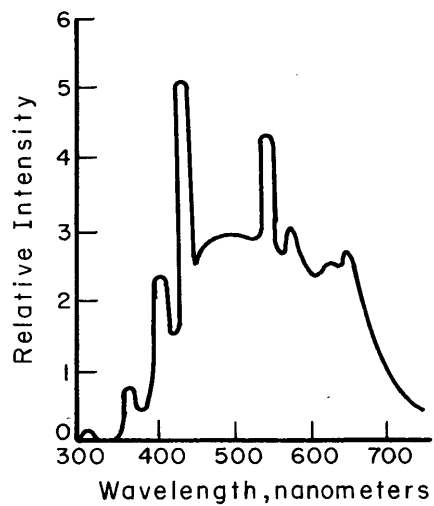

FIGURE 3.4 THE SPECTRAL ENERGY DISTRIBUTION FOR A 40-WATT DAYLIGHT FLUORESCENT LAMP

CONFIDENTIAL

NPIC/R-03/72

CONFIDENTIAL

Four things happen to the light that reaches an object. A fraction of the incident light is ABSORBED and dissipated within the object. Another fraction of the incident light is SCATTERED and does not reach the eye of the observer. The incident light that is neither absorbed nor scattered by the object is in part REFLECTED from the object and in part TRANSMITTED by it. The ratio of reflected to transmitted light depends on the nature of the object. A piece of white paper reflects most of the incident light, whereas a piece of clear glass transmits most of the incident light.

Objects in general do not reflect or transmit all wavelengths of incident light equally. At a given wavelength the ratio of light incident to light reflected or transmitted by the object is, called respectively, the SPECTRAL REFLECTANCE or SPECTRAL TRANSMITTANCE of the object. A graph in which the spectral reflectance (transmittance) is plotted for each wavelength throughout the spectrum is a SPECTRAL REFLECTANCE (TRANSMITTANCE) CURVE for that object.

Because light sources emit different amounts of light at each wavelength and objects reflect or transmit different amounts of light at each wavelength, the spectral composition of the light reaching the observer is a combination of the spectral energy distribution of the source and the spectral reflectance (transmittance) of the object. On the basis of logic and experimental evidence, the spectral composition of the light reaching the observer is known to be the same as the product formed by multiplying, wavelength by wavelength, the spectral distribution curve of the light source by the spectral reflectance (transmittance) curve for the object. An example of this point-by-point multiplication and the spectral energy distribution of the light reaching the observer are shown in Figure 3.5.

As discussed in Section 2.0, the observer's eye is not equally sensitive to all wavelengths of light. For normal room-lighting and image-viewing conditions, the standardized visual sensitivity or spectral response of the eye is given as the photopic curve (shown in Figure 2.6 and the middle of Figure 3.6). As is shown in Figure 3.6, the COLOR STIMULUS the observer receives is the combined product of the spectral energy distribution of the light and the spectral response characteristics of the eye. The eye transforms this color stimulus into nerve impulses that are sent to the brain. The observer perceives a color or experiences the sensation of color when this message is processed by the brain.

The physical aspects of color are concerned primarily with controlling and measuring the color stimulus that the observer receives and not with the nature of the color sensations that this color stimulus produces in the observer's brain. Although there are several exceptions,

CONFIDENTIAL

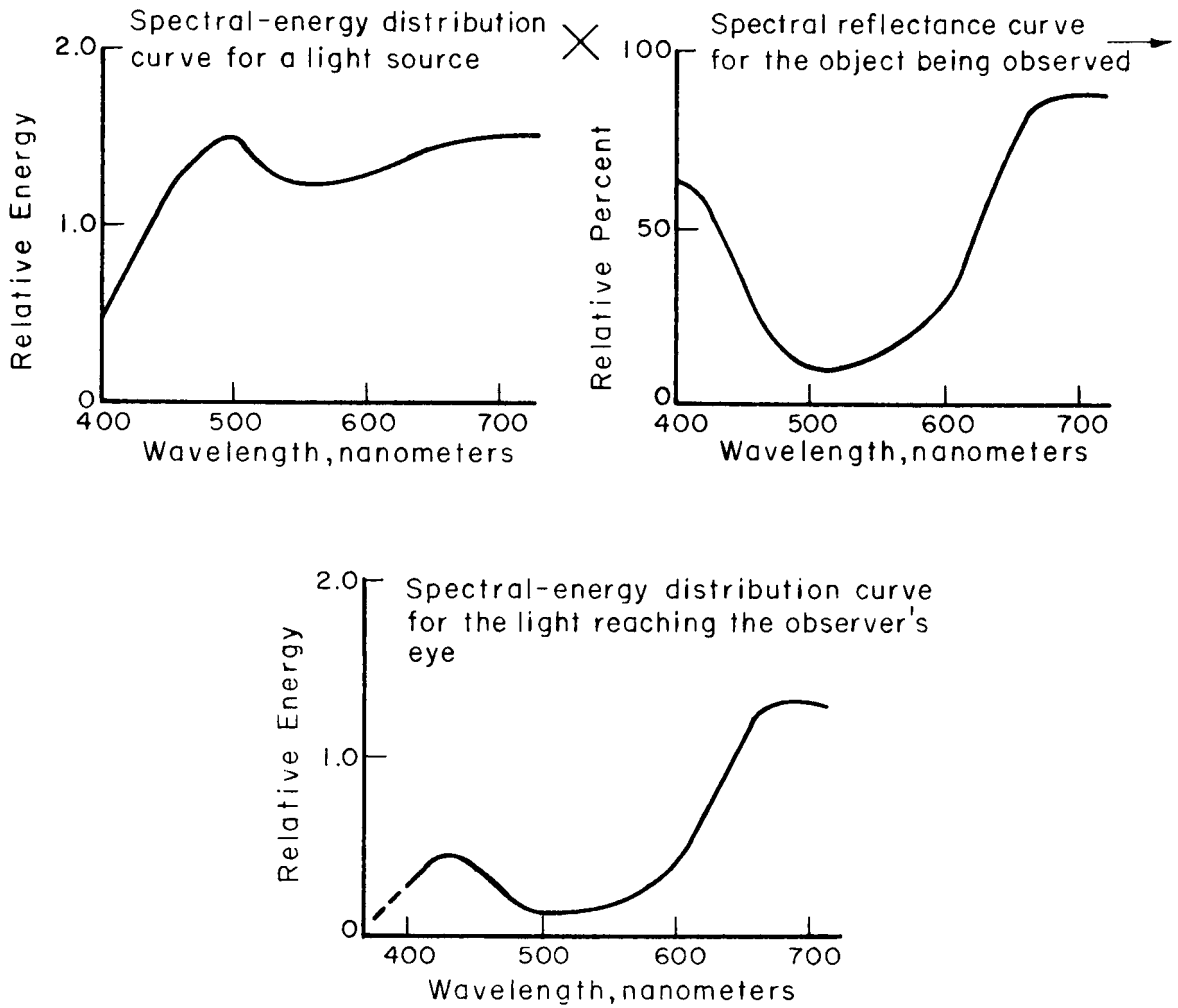

FIGURE 3.5 THE SPECTRAL ENERGY DISTRIBUTION OF THE LIGHT REACHING THE OBSERVER'S EYE

CONFIDENTIAL

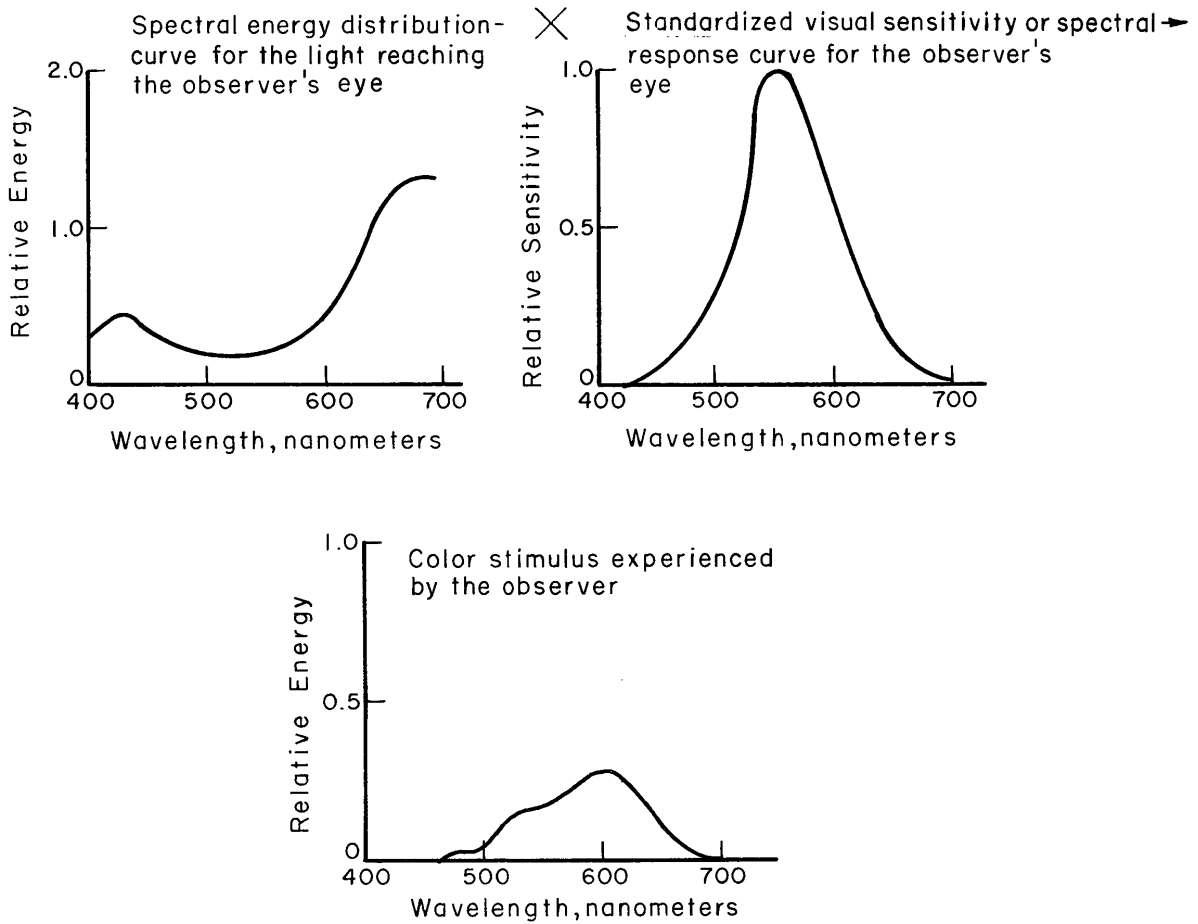

FIGURE 3.6 THE COLOR STIMULUS EXPERIENCED BY THE OBSERVER

CONFIDENTIAL

CONFIDENTIAL

CONFIDENTIAL

the spectral energy distribution of the color stimulus the observer receives is only roughly correlated with the color sensation this stimulus produces. The nature of the color sensations a color stimulus creates in the observer's brain are described best by the psychological aspects of color perception.

The three psychological aspects of color perception are HUE, SATURATION, and LIGHTNESS. Hue is denoted by red, blue, green, yellow, etc.; saturation is associated with the strength of a hue; lightness is that aspect by which an observer distinguishes between two achromatic (gray) objects. As the color stimulus is changed, the observer will perceive colors with different hues, saturations, and lightnesses.

3.2 THE ADDITIVE AND SUBTRACTIVE CONCEPT OF COLOR REPRODUCTION

Two basic techniques are used to reproduce color. Although they appear to be quite different, in principle, they are the same. An understanding of color reproduction will help the Center's personnel to develop an appreciation for the limitations and potentials of high-resolution, high-quality color photography and reproduction.

In the ADDITIVE process, a given color is reproduced by adding or blending varying amounts of any three conveniently selected colored lights, such as red, blue, and green. For example, cyan, a blue-green color is created by projecting both blue and green light onto a common area of a white screen. Similarly, yellow is produced by projecting red and green light, and magenta is produced by projecting red and blue light onto a common area of a screen. The visual sensation of white is created by projecting the proper proportions of the three selected colors, i.e., red, blue, and green, onto a common area of a white screen. Obviously, black or no color would be perceived if there is very little or no light projected.

In the SUBTRACTIVE process, a color is reproduced by using colored filters* to selectively remove practically all the undesired colors from a beam of white light. For example, red results from optically removing all colors except red from a beam of white light by using a red filter. Actually, since filters are not perfect, not quite all the undesirable color can be removed.

* A colored filter is an optical device that transmits particular wavelengths of light. For example, a green filter transmits primarily green light, and therefore, appears green to the normal observer.

CONFIDENTIAL

CONFIDENTIAL

3.2.1 The Additive Method of Color Reproduction

In principle, the additive color process reproduces a given color by adding or blending varying amounts of any three colors, e.g., red, blue, and green. This principle of additive color reproduction can be applied to color photography in the following way. Three simultaneous exposures of a scene are made with three equivalent cameras, located in approximately the same position. PANCHROMATIC black and white film in the cameras is exposed through red, blue, and green filters, one filter for each camera. Thus, the positive transparencies made from the three original negatives contain the red, blue, and green records of that scene. To reproduce this scene, the transparencies are projected through the appropriate filter, in register, onto a white screen. For example, only red light is emitted from the projector containing the red transparency record of the original scene. When the relative intensities of the three projectors are properly adjusted, the composite image on the screen approximates the color of the original scene. This general concept of additive color reproduction is illustrated in Figures 3.7 and 3.8. There are several modifications of this additive process, and some of them are capable of excellent color reproduction. However, the Center has not found it useful for intelligence extraction, because perfect registry is extremely difficult.

3.2.2 The Subtractive Method of Color Reproduction

Although color photographic films vary from one manufacturer to another, all subtractive color processes use some combination of CYAN, YELLOW, and MAGENTA dyes in layers of the film to act as filters. Spectral transmittance curves for a set of ideal cyan, magenta, and yellow dyes are shown at the top of Figure 3.9. Although an ideal cyan dye transmits light only in the blue and green portions of the visible spectrum, an actual dye will transmit some light in the red portion of the spectrum. As shown in the diagram, the magenta dye transmits a combination of red and blue light; the yellow dye, a combination of red and green light. Actual magenta and yellow dyes also transmit some extraneous wavelengths. The transmission of colors other than those for which the dye layers were designed is one of the major problems in reproducing imagery with the desired color balance and fidelity. As an example, if the "blues" are faithfully reproduced, then more than likely the "reds" and the "greens" in the image will not be a faithful reproduction of the original colors in the scene.

CONFIDENTIAL

CONFIDENTIAL

55

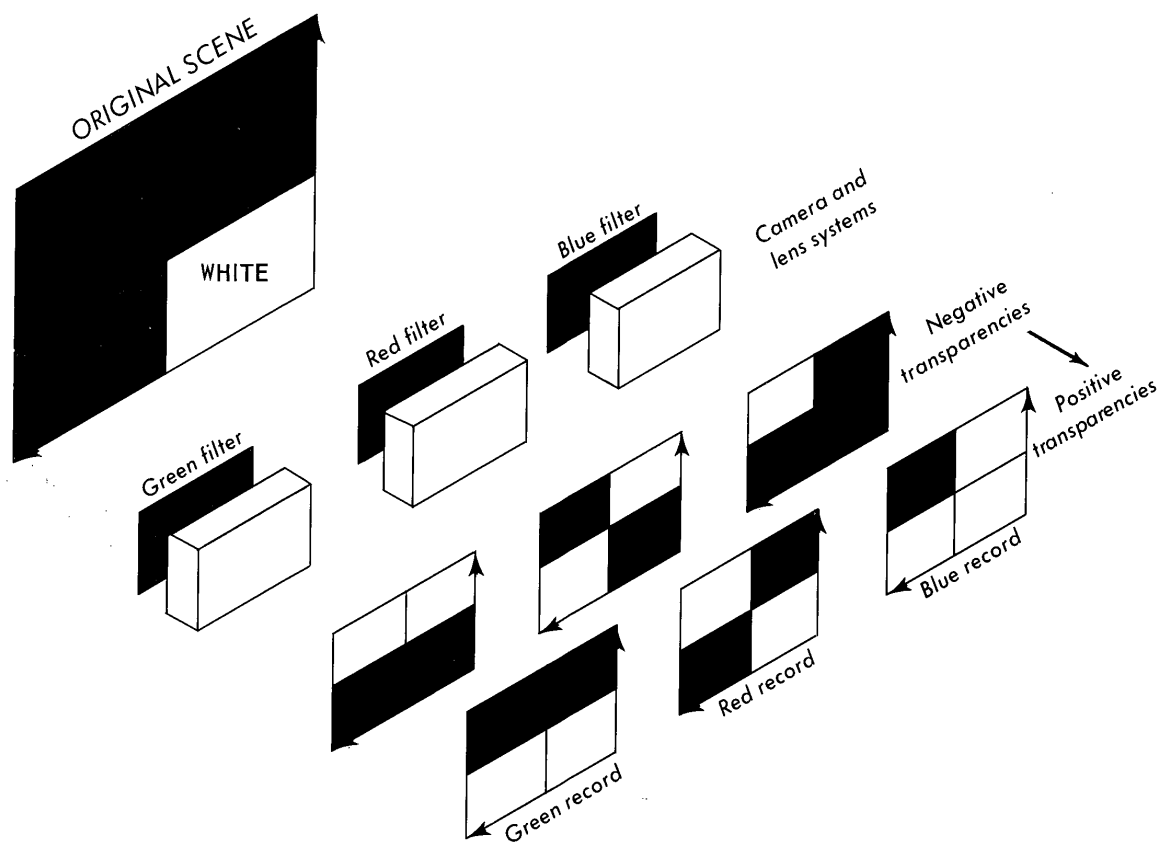

FIGURE 3.7 ADDITIVE COLOR PHOTOGRAPHY - TAKING THE PICTURE

CONFIDENTIAL

NPIC/R-03/72

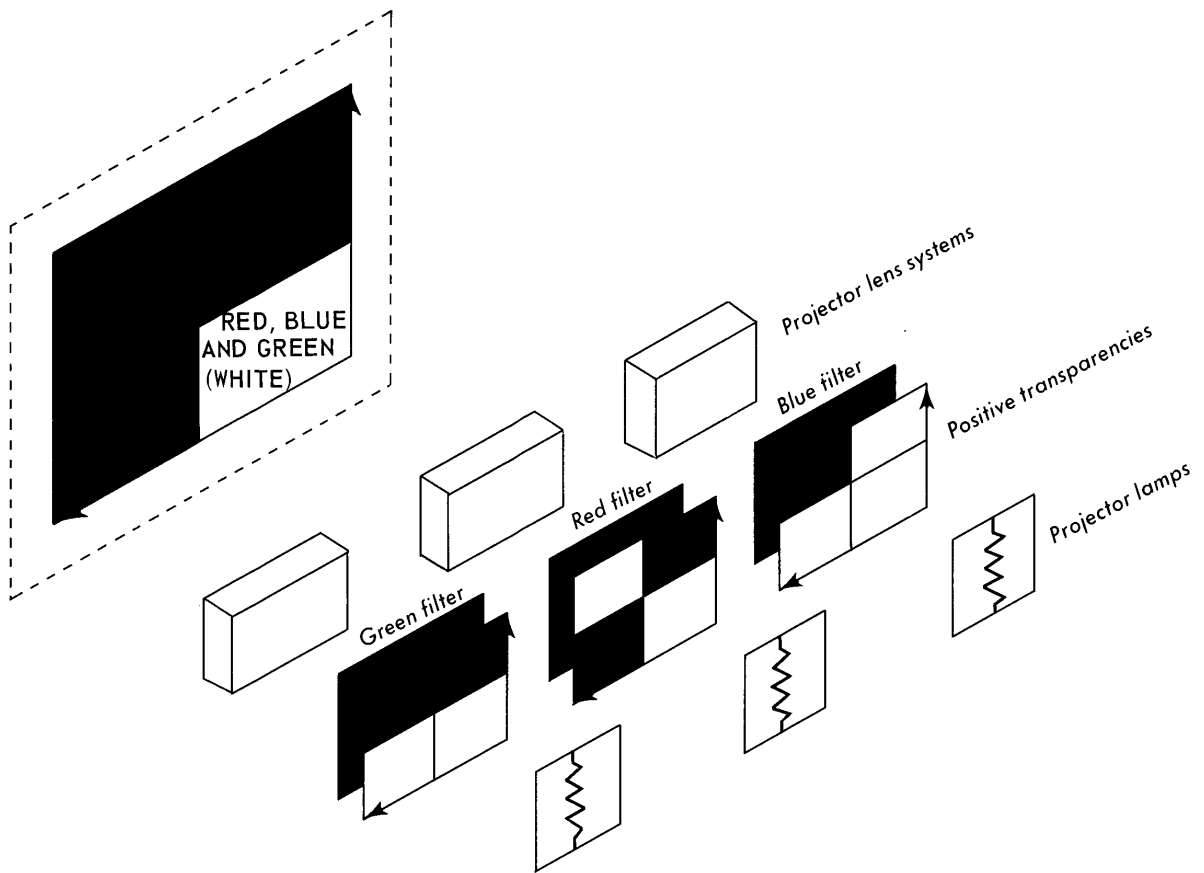

FIGURE 3.8 ADDITIVE COLOR PHOTOGRAPHY - RECONSTRUCTING THE PICTURE

CONFIDENTIAL

CONFIDENTIAL

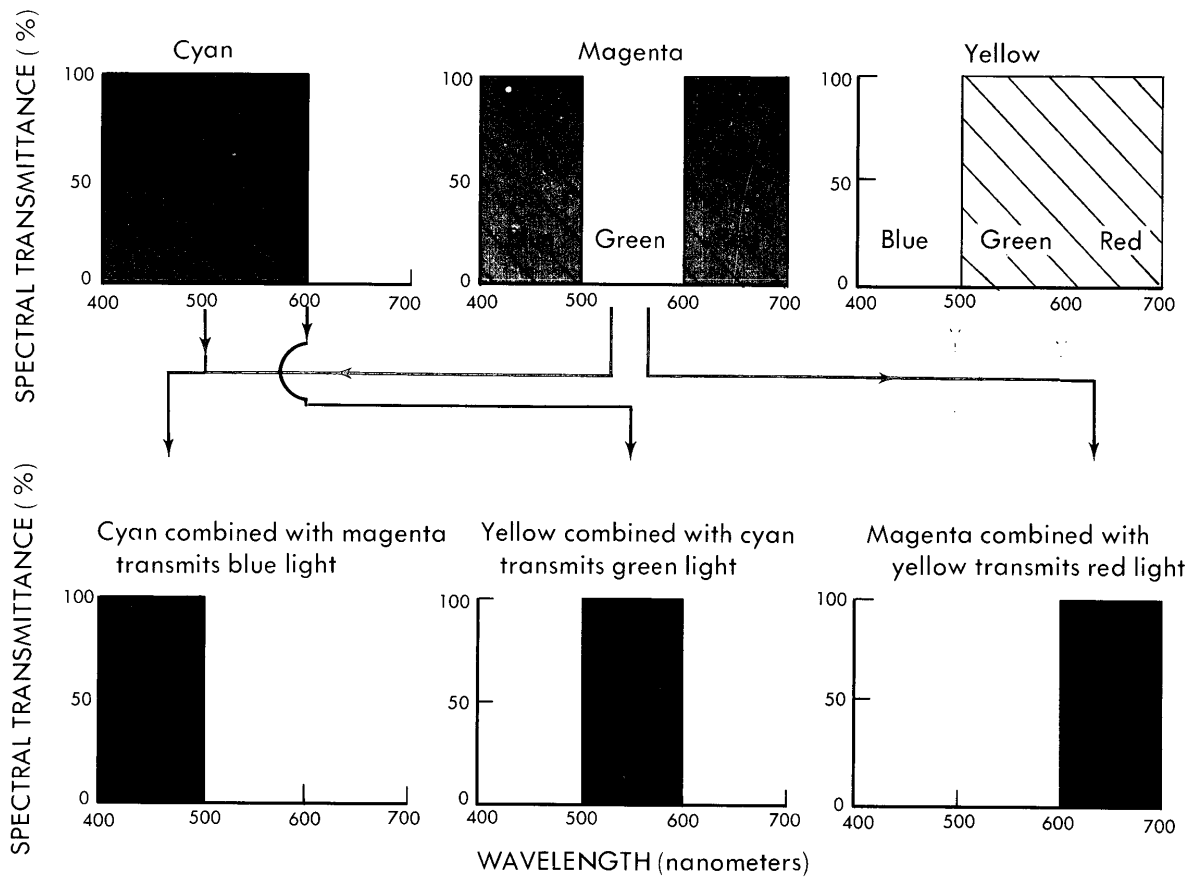

FIGURE 3.9 SPECTRAL TRANSMITTANCE CURVES FOR IDEALIZED CYAN, MAGENTA, and YELLOW DYES

CONFIDENTIAL

CONFIDENTIAL

CONFIDENTIAL

The center of Figure 3.9 indicates how various colors can be reproduced or matched by using various combinations of dyes. For example, blue will be seen when a white light is viewed through a filter containing a dispersion of both a cyan and magenta dye. The cyan filter transmits blue and green, and the magenta transmits blue and red. The color not blocked out by either filter is blue. The same blue color is seen when a white light is viewed through a filter formed by combining separate cyan and magenta filters.

The principle of subtractive color reproduction is used in most color positive films. The configuration of a typical color-positive or color-reversal* film is illustrated at the top of Figure 3.10. The film comprises at least four separate layers of photographic materials. The yellow layer (i.e., a minus blue filter) located below the blue-sensitive top prevents the blue light that exposes the top layer from also exposing the two bottom layers. These two bottom layers of photographic material in a typical color positive film are sensitive to green and red light, respectively. Although the drawing in Figure 3.10 shows these layers as being sensitive to only one particular color of light, they do have some sensitivity at all wavelengths. When a conventional color-positive film is exposed to a multicolored target like the one at the top of Figure 3.10, the response of each of the separate layers represents the red, blue, and green records of that particular scene. The exposed film is processed in a series of chemical baths. During the processing, the silver particles of the images, which are the records of the reds, blues, and greens in original scene, are replaced with images of cyan, yellow, and magenta dyes, respectively and the color of the original scene is reproduced by the combined effects of the dye deposits. For example, the image of a red stop sign is composed of both yellow and magenta dye images (see Figure 3.9), located in different layers of film. For whites, no dyes are deposited and for blacks, all three dyes are deposited so that every color is absorbed. Although the processing chemistry and construction of positive color materials is simplified here, most systems work by this same basic principle.

* The order of dye layers in S0-242 is inverted from that described above. In S0-242, the top layer contains the magenta dye deposits, the middle layer contains the cyan dye deposits, and the bottom layer contains the yellow dye deposits. The dye layer arrangement in S0-242 is an optimal arrangement because the magenta image creates the greatest visual effect on the viewer (see 4.4.1) and film resolution is, to the first approximation, a linearly decreasing function with increasing emulsion thickness. Thus, by using the S0-242 type dye layer arrangement, i.e., magenta, cyan, and yellow, and highly selective spectral sensitizers, it is possible to produce a high-resolution color film. Also, see Section 4.1 for a detailed discussion of color films.

CONFIDENTIAL

CONFIDENTIAL

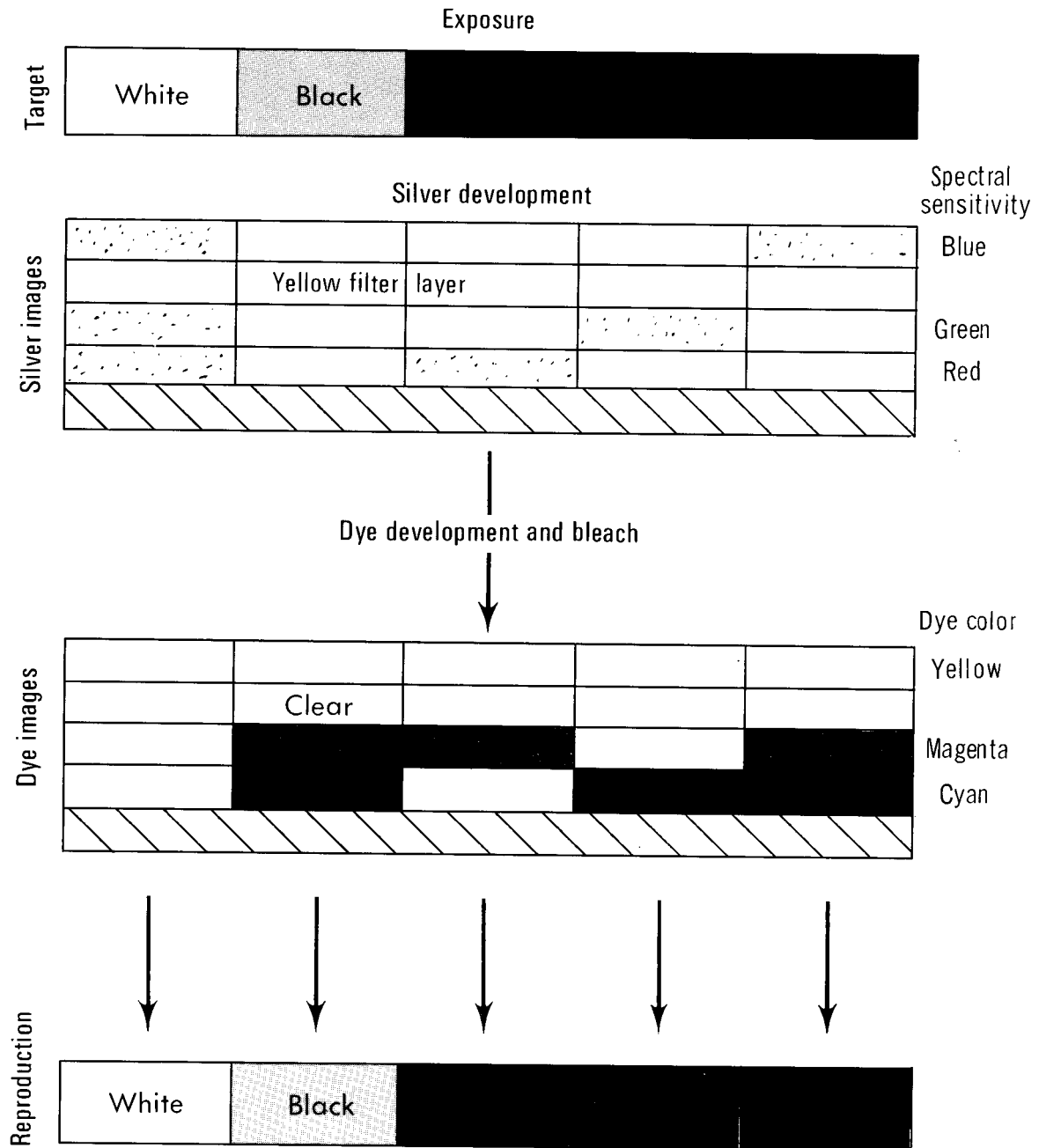

FIGURE 3.10 A COLOR REVERSAL PHOTOGRAPHIC PROCESS

CONFIDENTIAL

~~CONFIDENTIAL~~

REF ID: A66365

3.3 COLOR SYSTEMS

Although methods for identifying, specifying, and describing colors have been of scientific and artistic interest for many years, only in the past fifty years has there been much progress in meeting these objectives. Much of the impetus behind the development of these color systems came from an ever-increasing consumer demand for more colors and better color control. For example, it is important to the automobile industry that the color of various body parts match, even if they were made in different locations. Some color systems developed to satisfy these demands are quite specialized and others are general and can be applied to a wide variety of color matching, controlling, and specifying problems. Knowing the various applications and limitations of color systems is important to the photointerpreter and other Center personnel, because it provides them with a basic understanding of the common terms used by most people working on the technical aspects of color photography.

3.3.1 Munsell System

The Munsell color system is an orderly arrangement of colored plaques or chips for use in color matching and identification. The colors are selected so that there are nearly equal perceptual intervals between adjacent chips. To correspond to the three-dimensional concept of color, the Munsell chips are often arranged in the cylindrical pattern shown in Figure 3.11. In this color-order system, HUE is used to denote that attribute of color described by words like red, blue, and green, and is specified in the Munsell system by the capital letters R, B, and G, respectively. Each major color sector in the Munsell system is subdivided into smaller parts which are labeled with a numerical designation. For example, 6Y would be used to label the sixth division of the yellow sector of the Munsell space. The lightness or darkness of different colors in this system are designated by the term VALUE. A Munsell value of 0 on the vertical axis in Figure 3.11 represents black whereas a Munsell value of 10 at the top of the same axis represents white. Various shades of gray, the lightness or darkness of a neutral color, are designated by the Munsell values between these two extremes. For example, a Munsell value of 7 is used to specify a light gray color. The term CHROMA in the Munsell color system is used to specify the saturation or purity of the color, that is, how much that particular color differs from a neutral gray of the same lightness. For example, the chroma range of a color, with a hue of 2 YR and value 6, varies from a light brownish gray (a chroma of 1) to a vivid orange (a chroma of 14). The Munsell designation of the color of an opaque object is determined by

~~CONFIDENTIAL~~

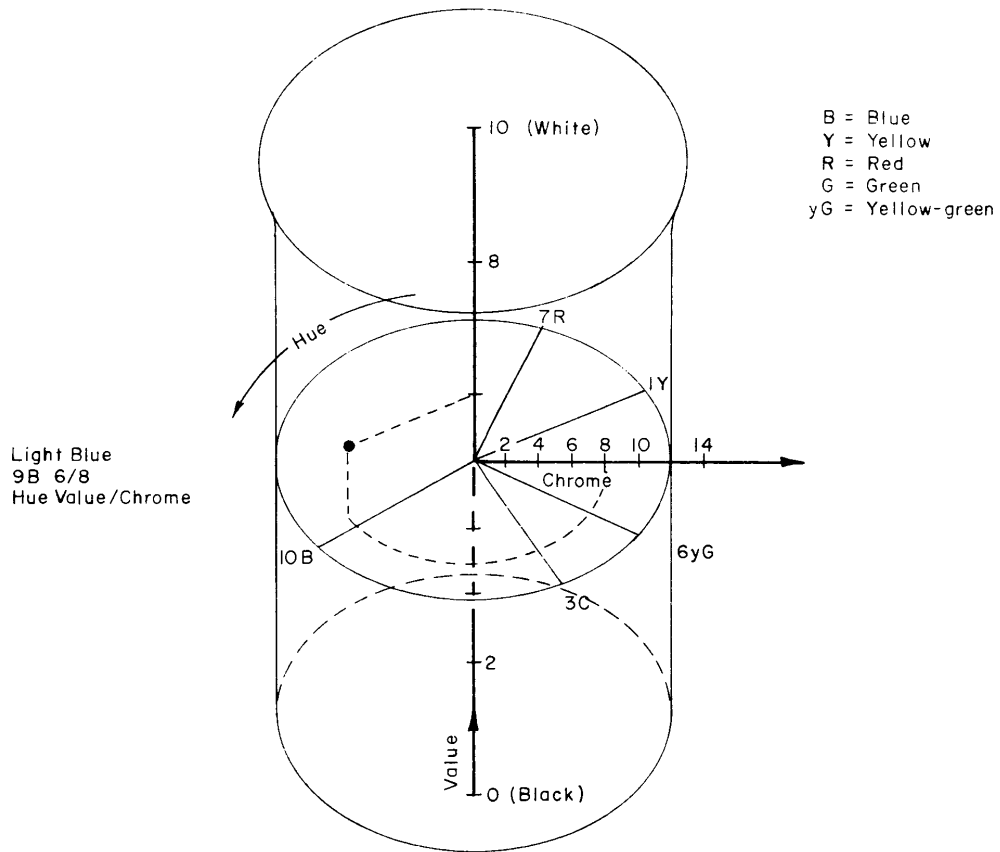

FIGURE 3.11 THE CONCEPT OF THE MUNSELL COLOR SYSTEM

CONFIDENTIAL

61

CONFIDENTIAL

NPIC/R-03/72

CONFIDENTIAL

REF ID: A67037

visually selecting that Munsell chip which is the nearest visual match to the color of the object. For example, the Munsell chip that appears to be the nearest color match to the color of a light-blue car might have the designation of 9B 6/8, i.e., HUE VALUE/CHROMA.

3.3.2 CIE System

The CIE (Commission Internationale de l'Eclairage) color system is based on the physical aspects of light and color perception; it is used primarily in the scientific and technical community. Early color scientists recognized that most colors projected onto a white screen could be visually matched by projecting varying amounts of red, blue, and green light from three other projectors onto a common area of the same screen. As experimentation progressed, it was discovered that individual observers with normal color vision required approximately the same amounts of the lights to achieve a match. To standardize color-matching and -designating procedures and to help communication about color, scientists, on behalf of the CIE, examined existing color-matching data. These color-matching data were statistically adjusted and then used to define a new set of color-matching functions for a STANDARD OBSERVER. These COLOR-MATCHING FUNCTIONS (\bar{x} , \bar{y} , \bar{z}) are shown in Figure 3.12*.

In addition to specifying the color-matching functions for the standard observer, the scientists also specified a set of standard light sources** known as CIE standard sources A, B, and C. Their spectral energy distributions are listed in most texts on color science. These standard distributions are important because the apparent color of a sample changes as the spectral energy distribution of the light illuminating the sample changes. The other factor that determines the color of an object is its spectral transmittance or reflectance (see 3.1 THE PHYSICAL ASPECTS OF COLOR). The CIE designation for a color can be calculated by combining the color-matching properties of the standard

* Although not specified in the definition of the standard observer, these color-matching functions are based on color-matching data that were collected for observers having a 2 degree field of view.

** In this report the terms SOURCE and ILLUMINANT are used as follows: A SOURCE is a physically realizable light, whose spectral energy distribution can be experimentally determined. When the determination is made and specified, the source becomes a standard source. An ILLUMINANT is a light defined by a spectral energy distribution, which may or may not be physically realizable as a source. If it is made available in physical form, it becomes a standard source. (Billmeyer and Saltzman; 1966).

CONFIDENTIAL

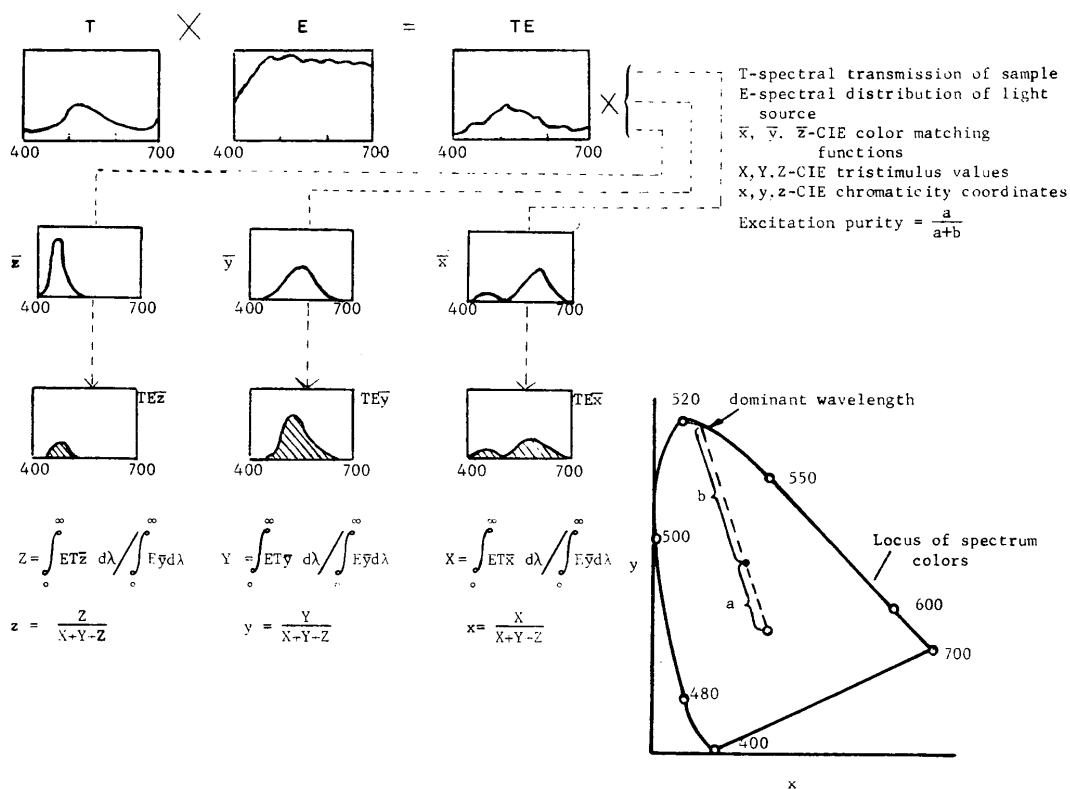

FIGURE 3.12 THE CIE COLOR SYSTEM

CONFIDENTIAL

CONFIDENTIAL

CONFIDENTIAL

observer, the spectral distribution of the standard source, and either the spectral transmittance or reflectance of the object.

In determining the CIE designation of an object, the first calculation is to form the product of T , the spectral transmittance (or R , the spectral reflectance) of the object and E , the spectral energy distribution of the standard source being used. This operation is demonstrated for a transparent object at the top of Figure 3.12. A new product is then formed by multiplying the initial result TE (or RE) times \bar{x} , \bar{y} , and \bar{z} , the color-matching functions. The curves representing these three products ($TE\bar{x}$, $TE\bar{y}$, $TE\bar{z}$) are shown at the end of the dashed line in Figure 3.12. The area under the curves, being the quantity of interest, it is calculated by standard numerical integration techniques. The CIE TRISTIMULUS VALUES (X , Y , Z) are the ratios of the areas under each the curves to the area under the spectral-distribution curve found by the product of spectral energy distribution of the CIE standard source being used and the \bar{y} color-matching function. These tristimulus values are used in the equations of Figure 3.12 to calculate the CIE CHROMATICITY COORDINATES, x , y , and z . The CIE color system is designed so that the sum of the values for x , y , and z is always equal to 1; therefore, it is only necessary to plot two of the chromaticity coordinates--by convention, x and y --on the CIE diagram (bottom right of Figure 3.12). The third dimension of the CIE color space, represented by the tristimulus value Y , is called the LIGHTNESS value of the color. The CIE tristimulus value Y corresponds to the lightness of the perceived color, because \bar{y} is the visual sensitivity or photopic curve for the average observer.

Two other terms are used in the CIE system. The DOMINANT WAVELENGTH of a color is represented by that point at which the locus of spectrum colors or the outer boundary of the CIE diagram is intersected by the line connecting the points on the CIE diagram representing the color of the object and the color of the CIE illuminant being used. The CIE EXCITATION PURITY of a color is a measure of how far the point representing a color is from the point representing the color of the CIE source and the locus of spectrum colors. The CIE color system is based on the characteristics of the standard observer, a given light source, and the reflectance or transmittance of objects being measured. Nevertheless, some numerical CIE designations can be related to the visually perceived aspects of color (hue, saturation, and lightness) through terms such as dominant wavelength, excitation purity, and lightness.

CONFIDENTIAL

CONFIDENTIAL

3.3.3 Lovibond System

The Lovibond color system is a color-specification system based on a set of glass filters. The various Lovibond glasses are made with a thin layer of color glass flashed onto a clear glass substrate. The red (R), blue (B), and yellow (Y) glasses* are made by adding gold, cobalt, and chromium, respectively, during manufacturing. Although calibrated in arbitrary units, there is a definite relationship between Lovibond glasses of the same or different colors. For example, a 6Y designation indicates a glass that has the same spectral transmittance as six 1Y glasses arranged in series. (This might designate a yellow-appearing filter with a chromium-enriched glass flashed on the clear supporting layer.) Similarly, a Lovibond glass designated 1R + 7B would have the same spectral transmittance as a series comprising one 1R and seven 1B glasses. The spectral transmittance of each Lovibond glass is adjusted so a combination of glasses with equal red, blue, and yellow designations would approximate a NEUTRAL DENSITY FILTER.

Typically, Lovibond glasses are used in determining the color of transparent objects. A LOVIBOND COLORIMETER is usually configured so that one-half of a back-lighted field of view is filled with the sample, and the other with Lovibond glasses. The observer tries various combinations of glasses until he determines a combination that provides the closest visual match to the sample's color. For example, 20B + 30Y might be the Lovibond designation for the color of a field of grass recorded in an aerial photograph.

3.3.4 Ostwald System

Ostwald's color system, which is very useful to artists and decorators, is based on the philosophical concept that colors could be characterized by their FULL-COLOR CONTENT (C), BLACK CONTENT (B), and WHITE CONTENT (W). His application of these concepts is shown in Figure 3.13. The spectral reflectance curve in Figure 3.13 is for an idealized colorant because such step-like changes in spectral reflectance can not be realized by an actual dye or pigment. The C, B, and W contents of such idealized colors were defined so that their sum would equal unity, i.e., $B + W + C = 1$. For a color defined in this manner, the standard Ostwald notation is a number that specifies one of the twenty-four hues used and

* The spectral transmittance curves for the red, blue, and yellow glasses indicate they are really magenta, cyan, and yellow glasses. Nevertheless, the conventional red, blue, and yellow notations are used.

CONFIDENTIAL

CONFIDENTIAL

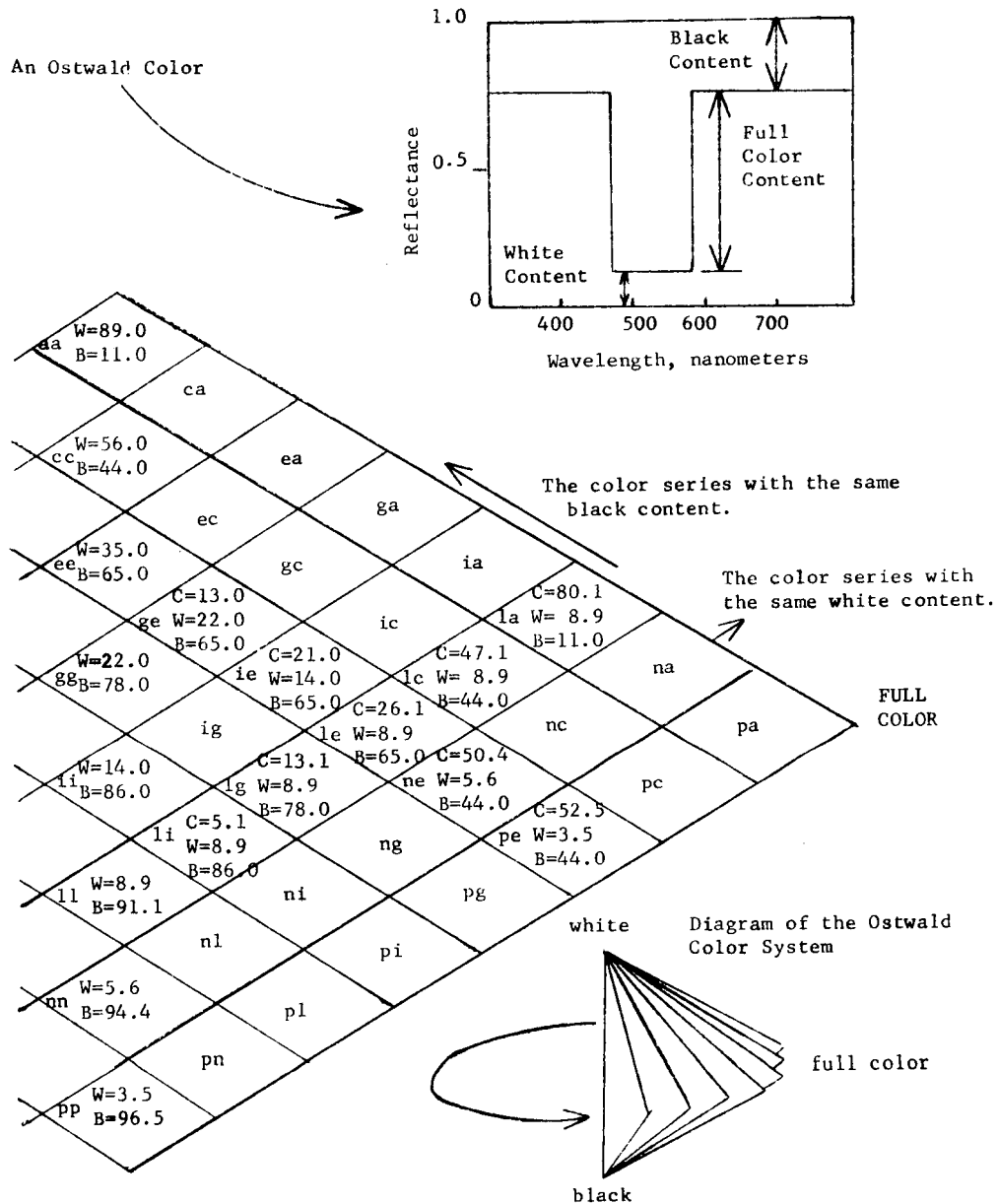

FIGURE 3.13 THE OSTWALD COLOR SYSTEM.

CONFIDENTIAL

CONFIDENTIAL

two lower-case letters whose combination denotes the white and black contents of the color, respectively. Although the lower-case letters in Figure 3.13 are standard Ostwald notation, the numerical values for the white, black, and full-color content of the various colors have been included. For example, the Ostwald notation "ne" denotes an Ostwald hue that has a white content of 5.6 percent, and the black content of 44.0 percent.

The idealized colors in Ostwald system have some very interesting colorimetric properties. For example, the series of colors in any one of the diagonal columns have the same dominant wavelength, but their excitation purity increases toward the outer boundary of the diagram. Those colors in any vertical column have the same chromaticity coordinates, or constant excitation purities, but their lightnesses increases from the bottom to the top of the diagram. The Ostwald hues, arranged in a circular pattern as shown in the diagram at the lower right of Figure 3.12, represent approximately equal intervals of visual perception. Thus, the Ostwald color system is a possible basis for a psychophysical color system like the CIE.

The Ostwald color of an opaque object is determined by visually selecting that Ostwald color sample or chip that is the closest color match to the color of the object.

3.3.5 DIN System

The DIN (Deutsche Industrie Norm) color system is the official German color system. The three DIN color coordinates are called FARBTON (T)*, SÄTTIGUNG (S), and DUNKELSTUFE (D). In the DIN system, D is defined as a logarithmic function of the relative lightness** expressed as the ratio of the luminous reflectance of the color sample to the luminous reflectance of an optimal color. An optimal color has the maximum luminous reflectance of all those colors that have the same chromaticity coordinates as the sample. The D scale in the DIN color system is equally spaced for both chromatic and achromatic colors. The dominant wavelengths of the twenty-four different "T's" used in the system were selected so that different hues would be spaced in nearly equal perceptual steps. The lines radiating from the point representing the CIE standard source C in Figure 3.14 are lines of constant DIN-Farbton or constant T. The curves enclosing the point representing the

* F has also been used.

** A more literal translation of Dunkelstufe would be "darkness degree".

CONFIDENTIAL

CONFIDENTIAL

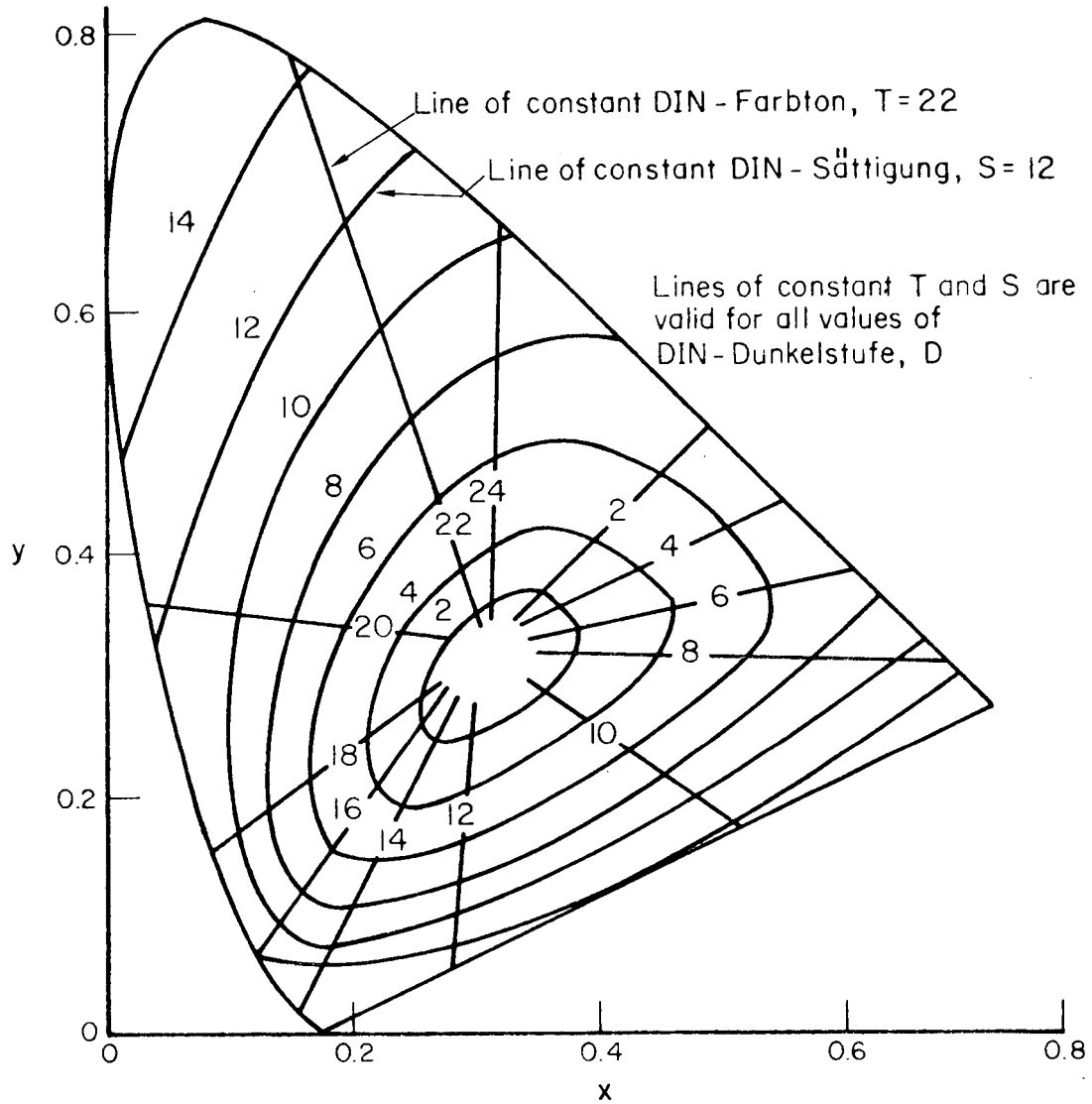

FIGURE 3.14 THE LINES OF CONSTANT DIN-FARBTON AND DIN-SÄTTIGUNG PLOTTED ON A 1931 CIE DIAGRAM

CONFIDENTIAL

~~CONFIDENTIAL~~

C source on the CIE diagram in Figure 3.14 represent levels of equal visual saturation or constant S.

The color designation of an opaque object is determined by visually selecting the DIN chip that most nearly matches the color of the object. This color designation is written as T:S:D. For example, a yellow rose might be designated as 2:6:1 in the DIN color system.

3.3.6 Densitometric Munsell System

The densitometric Munsell color-measurement system, based on the Munsell color-order system, is designed for use in extracting colorimetric information from prints and transparencies. However, the Munsell hue, value, and chroma of the color of an image is determined by measuring with densitometers and doing calculating (using nomographs) rather than visually matching the colors of a target and a Munsell chip. The nomographs were constructed by measuring the red, blue, green, and visual reflection densities of a set of selected Munsell chips. Although the Munsell chips are opaque, the Munsell designation for the color of a target on a transparency may be determined by using the same nomograph provided that the transmission densitometer has the same optical characteristics, e.g., acceptance angle, transmittance of filters, etc., as the reflection densitometer used in constructing the nomographs.

To determine the Munsell color designation of a target in an aerial photograph, the red, blue, green, and visual reflection or transmission densities of that target are measured. The differences between the highest and lowest density reading and between the intermediate density reading and the lowest density reading are calculated. The ratio of these differences is also calculated. The Munsell hue, value, and chroma of the image are determined by using the calculated values and the nomographs described above.

3.3.7 ISCC-NBS System

The ISCC-NBS (Inter-Society Color Council - National Bureau of Standards) color system was designed to aid in determining and specifying the colors of drugs and chemicals; however, it has found a much wider application in industry and science. The ISCC-NBS color system is essentially the result of applying a color-naming system to the Munsell color system. As previously discussed, hue, value, and chroma are the three dimensions of the Munsell color space, and they are arranged so that

~~CONFIDENTIAL~~

CONFIDENTIAL

they form a cylindrically shaped color solid in which all colors having similar hue, value, and chroma are contained in a small cell or volume of the solid. The concept of the ISCC-NBS color system is that all colors whose Munsell coordinates fall within this cell are labeled with and called by the same name. To conform with the existing color-naming conventions, the Munsell color volume was arbitrarily divided into 267 individual color cells or color volumes. The hue circle of the Munsell system was divided into 28 parts and given the names listed in Figure 3.15. The modifiers to be used with these hue names were selected to denote the relative chroma and value of the colors contained within a given color cell. Examples of these hue modifiers are shown in Figure 3.16 for a purple hue.

3.3.8 NuHue, Plochere, Ridgway, Maerz and Paul, Villalobos, Textile Color Card Association, and Methuin.

Each of these color-naming systems, based on an orderly arrangement of colored plaques or chips, was designed for use by a specific industry or profession, e.g., the Ridgway system is used by biologists for labeling specimens and the NuHue system is used by the paint industry to specify the color of various paints. These systems are adequate for the specialized purposes for which they were designed; however, it is difficult to tell anything about a color from the name given to it by these various color systems. A color designated as Light Blue by the ISCC-NBS color-naming convention is called Diana, Good Omen, King's Blue, and Forget-me-not by Maerz and Paul, Polchere, Ridgway, and the Textile Color Card Association, respectively. Unfortunately, the color chips or samples for many of these systems were made by using paints whose composition was unknown or cannot be duplicated.

3.4 COLORIMETRY--THE MEASUREMENT OF COLOR

Colorimetry is the art of measuring the color of an object in terms of words or numbers that uniquely specify the color of the object with respect to some specified color system. The purpose of such measurements may be the grading of agricultural commodities such as linseed oil, or determining the acidity of a solution of known chemical composition. In all instances, the objective of these measurements is to determine and specify the color of the object in terms that can be related to some known and standardized color system. Either visual or instrumental methods may be used for such measurements of color. Such methods should be of interest to the Center because a color vocabulary may involve some aspect of color measurement. Therefore, it is important to have an understanding of the basic concepts of colorimetry.

CONFIDENTIAL

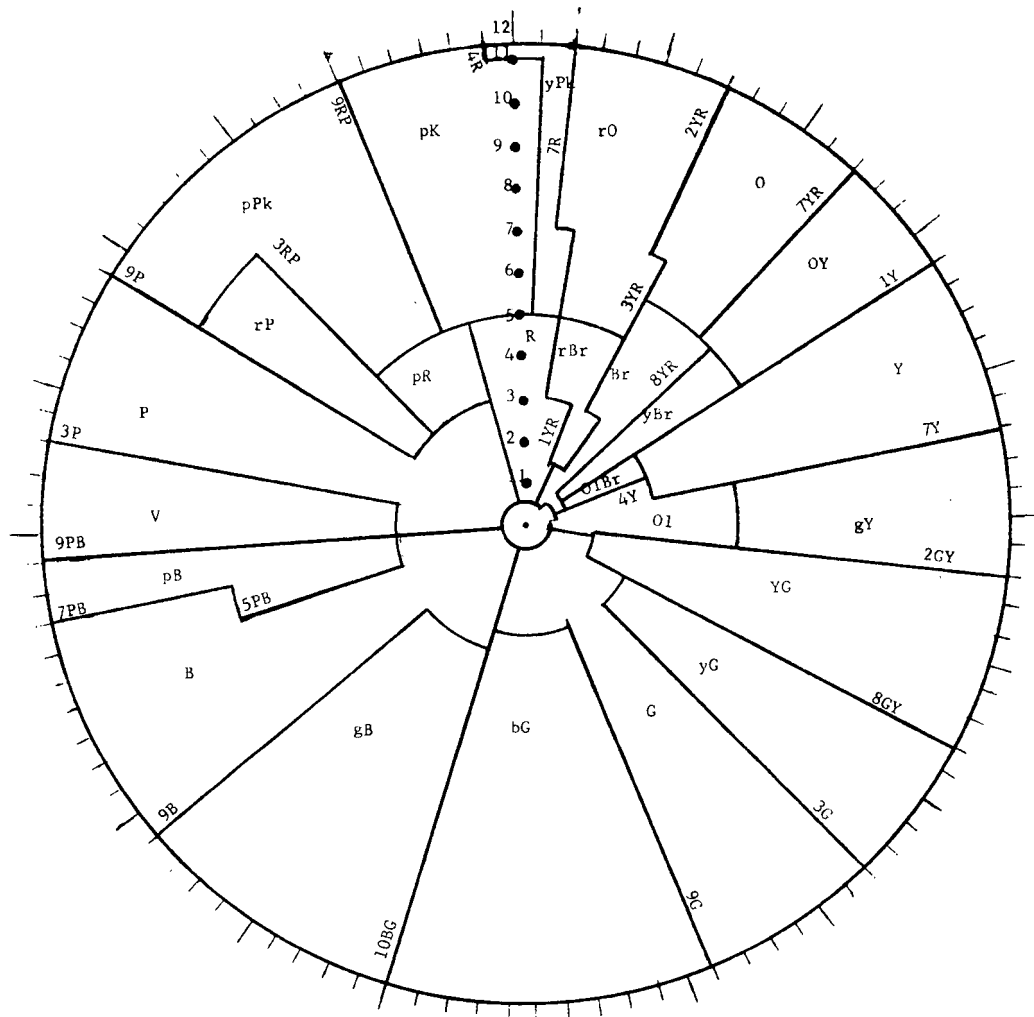

| Name | Abbreviation | Name | Abbreviation |
|-----------------|--------------|-----------------|--------------|
| Red | R | Purple | P |
| Reddish orange | rO | Reddish purple | rP |
| Orange | O | Purplish red | pR |
| Orange-yellow | OY | Purplish pink | pPk |
| Yellow | Y | Pink | Pk |
| Greenish yellow | gY | Yellowish pink | yPk |
| Yellow-green | YG | Brownish pink | brPk |
| Yellowish green | yG | Brownish orange | brO |
| Green | G | Reddish brown | rBr |
| Bluish green | bG | Brown | Br |
| Greenish blue | gB | Yellowish brown | yBr |
| Blue | B | Olive-brown | OlBr |
| Purplish blue | pB | Olive | Ol |
| Violet | V | Olive-green | OlG |

FIGURE 3.15 THE ISCC-NBS HUE NAMES AND ABBREVIATIONS FOR A CONSTANT MUNSELL VALUE OF SIX (Judd and Wyszecki, 1963; Judd and Kelly, 1955)

CONFIDENTIAL

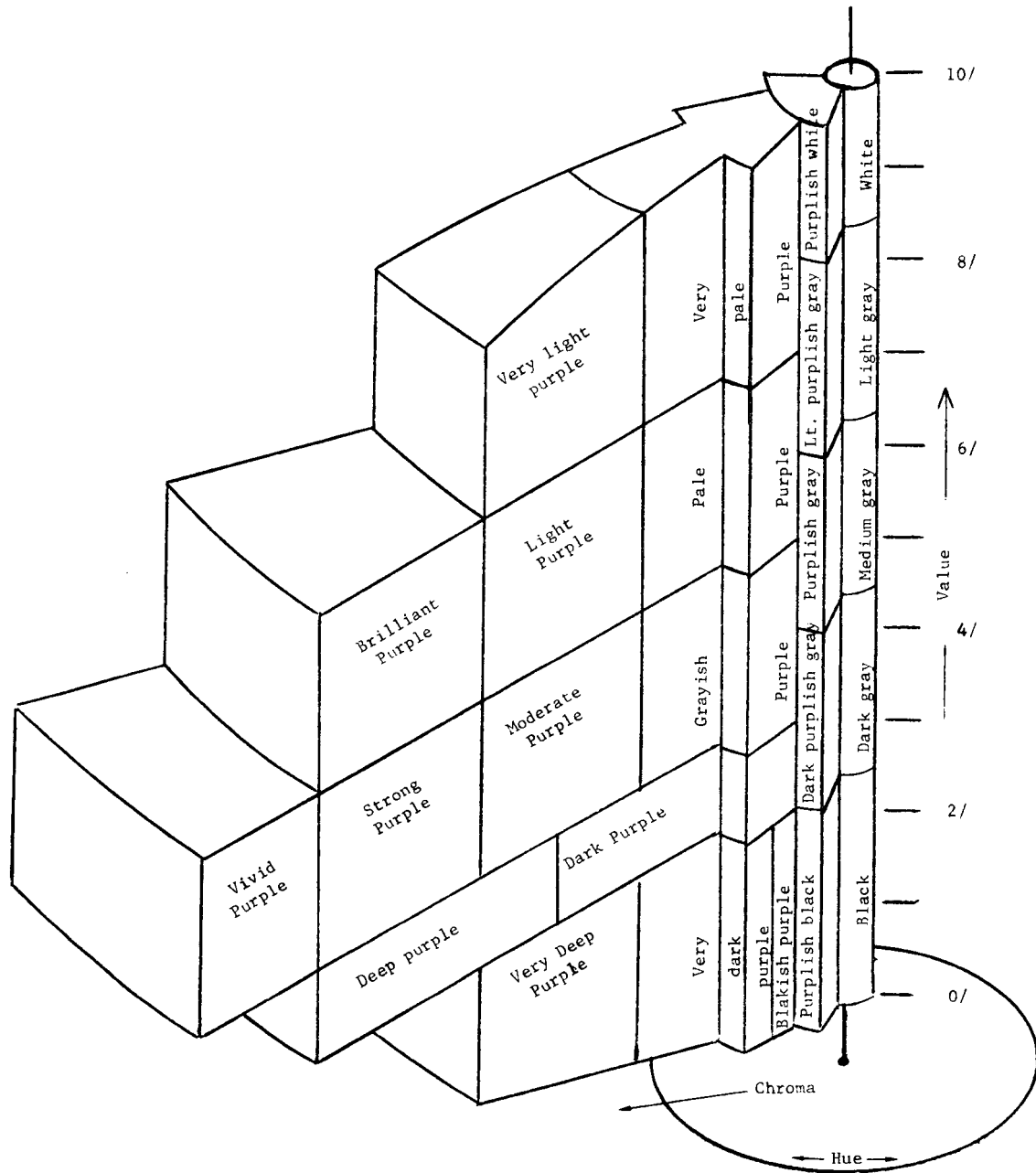

FIGURE 3.16 THE ISCC-NBS MODIFIERS FOR A PURPLE HUE (Judd and Wyszecki, 1963)

CONFIDENTIAL

CONFIDENTIAL

3.4.1 Instrumental Colorimetry

The primary objective of instrumental colorimetry is to determine the CIE tristimulus values X, Y, and Z (see 3.3.2 CIE COLOR SYSTEM) for a given transparent or opaque sample. These CIE tristimulus values are used to calculate the CIE chromaticity coordinates x and y for the color of the sample. Two of the instruments frequently used in colorimetry are the RECORDING SPECTROPHOTOMETER and the TRISTIMULUS COLORIMETER. The spectrophotometer is used to measure the spectral reflectance of opaque samples or the spectral transmittance of transparent samples. These measured values for the spectral transmittance or the spectral reflectance of the sample are used in calculating the CIE tristimulus values for the color of that sample. Colorimeters, on the other hand, are designed to measure directly the approximate CIE tristimulus values for the color of a sample.

3.4.1.1 Recording Spectrophotometer

The functional design of a recording SPECTROPHOTOMETER is diagrammed in Figure 3.17. The light sources used in these instruments emit electromagnetic radiation in the visible, near-ultraviolet, and near-infrared portion of the spectrum. Most instruments, have a wavelength range from 300 to 800 nanometers. The light emitted by the lamp is collected and directed into the entrance port of the wavelength selection device by the COLLIMATION OPTICS. The wavelength-selection device is a prism or a diffraction grating* that rotates and sweeps light of various wavelengths across the narrow slits in front of the sample. The width of this opening is adjusted to pass a 5 to 10-nanometer band of light, thus, illuminating the sample with a collimated beam of nearly monochromatic light. A transducer connected to the prism or grating generates an electrical signal proportional to the rotation of the prism or grating, hence proportional to the wavelength of the entering light. This electrical signal is used to control the horizontal motion of the pen or an x-y recorder. The light that passes through the sample is collected and focused onto the surface of the light detector whose electrical signal is proportional to the amount of light that is being transmitted by the sample. When the signal from the light detector is used to control the vertical motion of the pen of an x-y recorder, the pen trace in x is wavelength and that in y is intensity. Thus, the spectral transmission of the sample is recorded. If an opaque sample

* Both prisms and diffraction gratings are devices for separating or dispersing light into its components.

CONFIDENTIAL

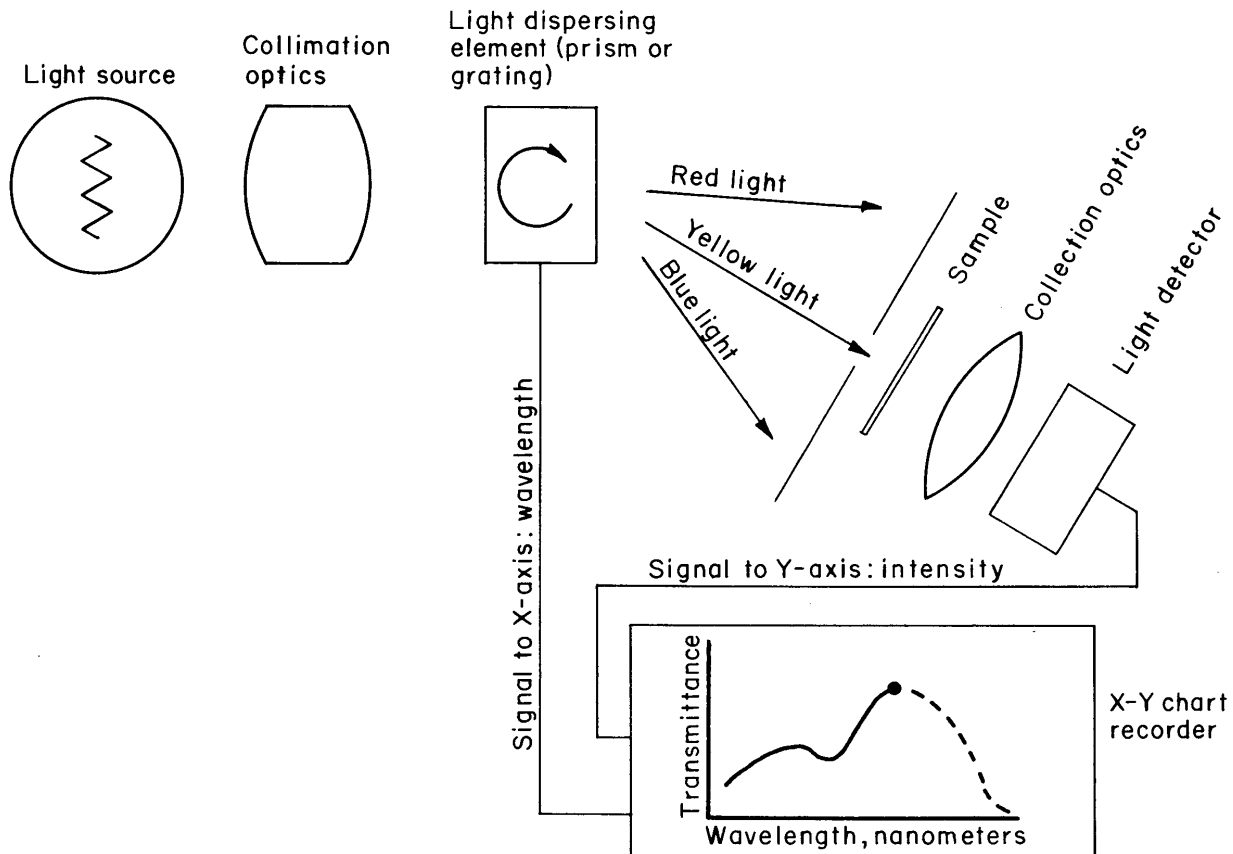

FIGURE 3.17 A SCHEMATIC DIAGRAM OF A SPECTROPHOTOMETER BEING USED TO MEASURE THE SPECTRAL TRANSMITTANCE OF A SAMPLE

CONFIDENTIAL

CONFIDENTIAL

CONFIDENTIAL

were being measured, the collection optics would be replaced by an INTEGRATING SPHERE that would collect most of the light reflected from the sample. Here, the trace produced on the x-y recorder would be a record of the reflectance of the sample at each wavelength from 300 to 800 nanometers. The CIE tristimulus values X, Y, and Z would be calculated from this data. (see:3.3.2).

3.4.1.2 Tristimulus Colorimeter

The functional design of a TRISTIMULUS COLORIMETER is diagrammed in Figure 3.18. The light emitted by the lamp is collected by the COLLIMATION OPTICS and projected onto the colored sample. Below the collimating optics is a set of three filters that can be individually placed in the beam of light that is being projected onto the sample. The SPECTRAL ENERGY DISTRIBUTION of the light reaching the sample is the combination of the spectral properties of the light source and the spectral transmittance of the particular filter that is in the beam of light. The light that is reflected from the sample is collected and focused onto the light detector. The spectral energy distribution of the light reaching the light detector is a combination of the spectral energy distribution reaching the sample and the spectral reflectance of the sample. Like the human eye, the light detector in the tristimulus colorimeter does not respond equally to all wavelengths; it too has a characteristic spectral response. The strength of the electrical signal generated by the light detector is proportional to the sum or integral of the combined product (wavelength by wavelength) of the spectral energy distribution reaching the light detector and the spectral response of the light detector.

In a tristimulus colorimeter the spectral properties of the filters, the light source, and the light detector are selected so that on a wavelength-by-wavelength basis their combined spectral properties are equal or nearly equal to some linear combination of the products formed separately by the three color-matching functions and one of the CIE standard sources. Thus, these colorimeters are designed so that the CIE tristimulus values X, Y, and Z are related to the strength of the signals that are received when each of the three filters are in the projected beam of light.

3.4.2 Visual Colorimetry

VISUAL COLORIMETRY includes all those color-measuring procedures or methods that require an observer who has normal color vision to use his judgment as to whether or not two colors are identical under a given set of

CONFIDENTIAL

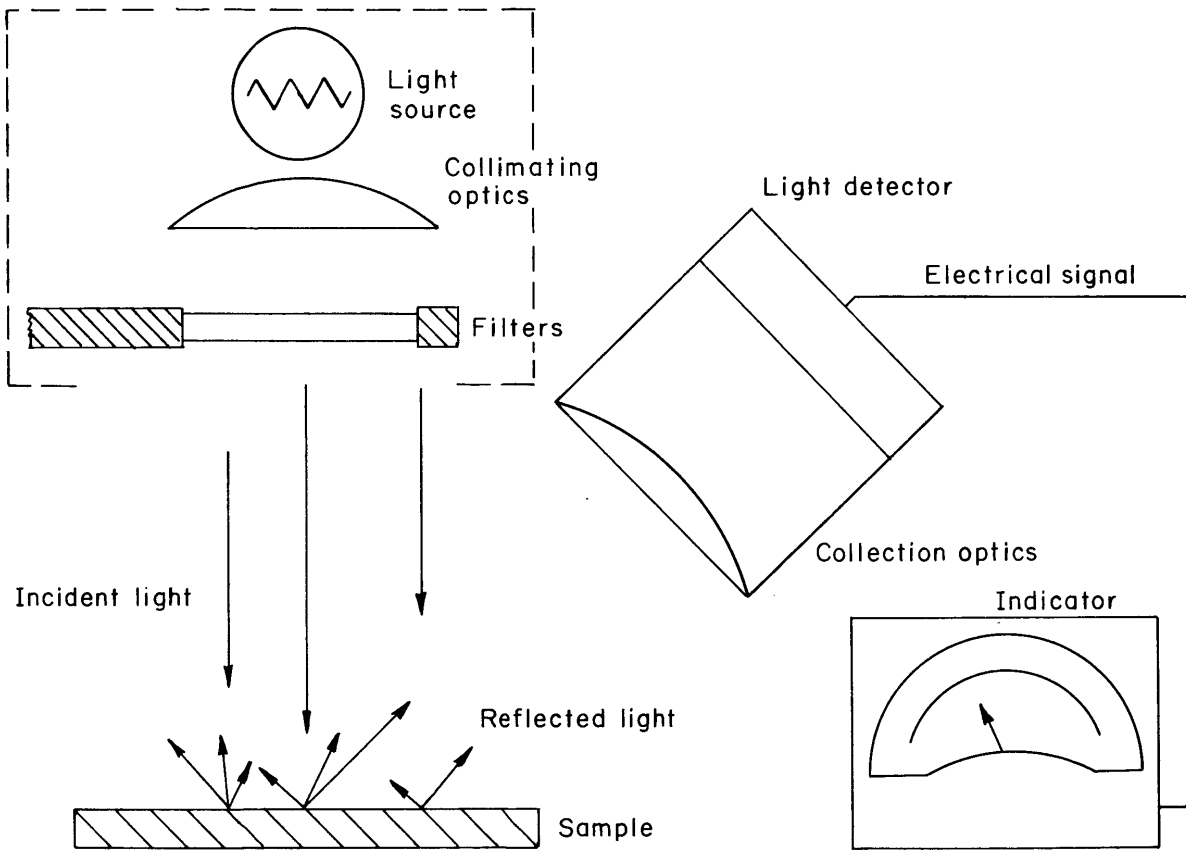

FIGURE 3.18 A SCHEMATIC DIAGRAM OF A TRISTIMULUS COLORIMETER

CONFIDENTIAL

76

CONFIDENTIAL

NPIC/R-03/72

CONFIDENTIAL

viewing conditions. To increase the accuracy and precision of such visual color-matching techniques, viewing conditions for the observer are specified and carefully controlled. In a typical visual colorimeter, the observer's viewing conditions are controlled by restricting not only the elements in his field of view, but also its size. The observer's field of view is usually divided into two symmetrically shaped sections, one-half is filled with light of an unknown color designation and the other half (the comparison field) is filled with a series of known colors. The observer adjusts the color of the comparison field until it visually matches the unknown color. The unknown color then identified as the known color in the comparison field. VISUAL TRISTIMULUS COLORIMETERS are designed so that the CIE tristimulus values X, Y, Z, for the color of comparison field can be readily determined by knowing the amount of light or combination of filters that the subject used to match the unknown color. The CIE chromaticity coordinates for the unknown color can be readily calculated once these tristimulus values are determined.

In some visual colorimeters, the color of the comparison field can be adjusted to produce a continuous range of colors. That is, the dominant wavelength, purity, and lightness (see Section 3.3.2) of the comparison field can be varied independently over a wide range of values. Other visual colorimeters are designed so that color, i.e., dominant wavelength, purity, lightness, can be varied only in small but discrete steps. In such a device, the color of the comparison field is controlled by a set of filters whose colorimetric characteristics vary in a desired manner.

3.4.3. Treatment of Colorimetric Data and Error Analysis

In colorimetry, the treatment of experimental data and error analysis is a critical aspect of a research project. The problem is compounded both by the extreme sensitivity of the eye to slight differences in color and by the difficulty in doing very accurate and precise PHOTOMETRY. In too many cases, the eye can detect a difference between two colors that are measured as being identical. The eye can detect the difference between two colors that differ by 0.2 of the CIE COLOR-DIFFERENCE UNIT. By using this value as a measure of the color sensitivity of the eye to color differences and standard error-analysis and error-propagation techniques, the effect of experimental errors on the color measurement process is determined.

A colorimeter or spectrophotometer should have the following properties if its performance is to equal or exceed the human eye. The range of wavelengths used at any one time to illuminate the sample should be less than 7.0 nanometers. For the instrument to equal the performance

CONFIDENTIAL

CONFIDENTIAL

of the eye, its systematic wavelength errors should be less than 0.2 nanometer and its random wavelength errors should be less than 0.3 nanometer. Experimental errors in measuring reflectance or transmittance of a sample should be less than 0.4 percent if the errors are independent of both the wavelength and the optical properties of the sample. If the spectrophotometric errors are not independent of these factors, then the specified tolerances should be considerably less. For such precision and accuracy to be maintained, the CIE tristimulus values should be calculated by using a summation interval of not more than 10 nanometers. In general, these are very stringent requirements and they are fulfilled only by very careful experimenters using the very best equipment.

An understanding and appreciation of the nature and magnitude of colorimetric errors is important to the Center and the interpretation of aerial color photography. For example, if the colors of two images were measured to be identical and several of the photointerpreters could detect a difference between them, there could be considerable time and effort wasted in debating whether the instrument or the interpreters were correct. (Both of them could be correct if the nature and the magnitude of the colorimetric errors were taken into consideration and properly interpreted.)

3.4.4 Metamerism and Metameric Colors

One of the most confusing and difficult problems in work with colors is that a given pair of colors will match under one set of viewing or measuring conditions, but may not match under another slightly different set of viewing or measuring conditions. This phenomenon of color matching is called METAMERISM and the colors that behave in this manner are called METAMERIC PAIRS. Metameric pairs occur when two samples with different spectral reflectance curves have the same chromaticity coordinates (see 3.3.2 CIE Color System). The spectral reflectance curves (hypothetical in this example) for the two samples in Figure 3.19 are quite different, but their CIE tristimulus values are the same. Thus, they form a metameric pair when illuminated by light from the CIE standard source C but appear to be quite different when illuminated by light from the CIE standard source A. The spectral energy distribution for CIE light sources A and C are shown in Figure 3.20. The magnitude and direction of this color shift is plotted on the CIE diagram in Figure 3.21. Metamerism is caused by the summation or integration process that occurs in the human visual mechanism and colorimetric calculations. A metameric pair is formed when the sums or integrals of the products used in the CIE calculations are equal but the individual terms in the summation or integration are different. By analogy, 2 plus 3 equals 4 plus 1, but neither 2 nor 3 is equal to either 4 or 1. Thus sets [2,3] and [4,1] form a metameric pair of numbers under addition.

CONFIDENTIAL

CONFIDENTIAL

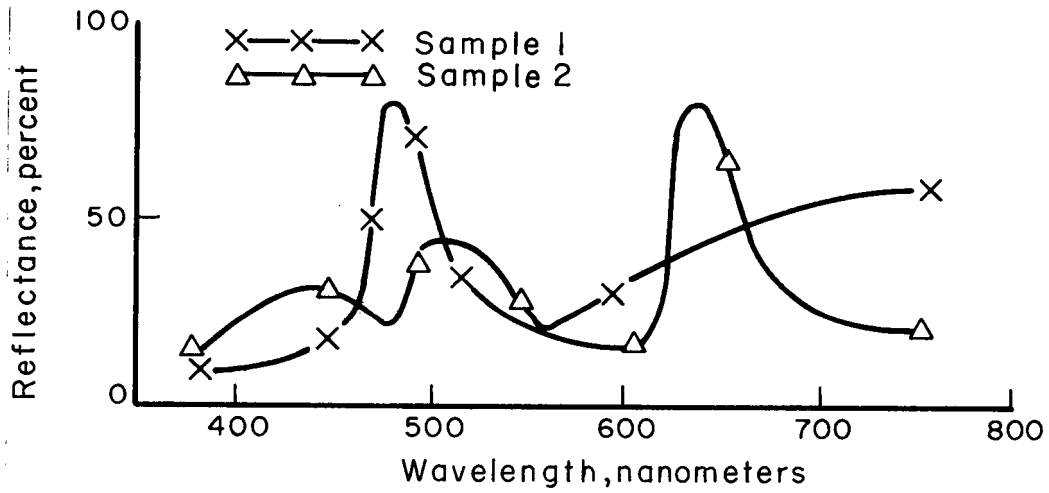

FIGURE 3.19 THE SPECTRAL REFLECTANCE CURVES FOR A METAMERIC PAIR OF COLORS

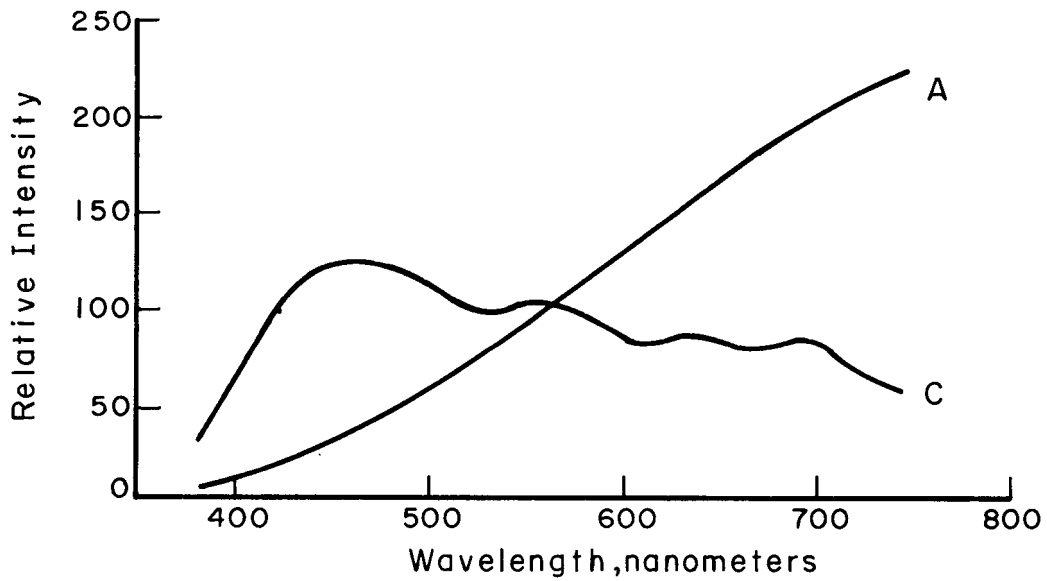

FIGURE 3.20 THE SPECTRAL ENERGY DISTRIBUTIONS FOR THE CIE STANDARD SOURCES A AND C

CONFIDENTIAL

CONFIDENTIAL

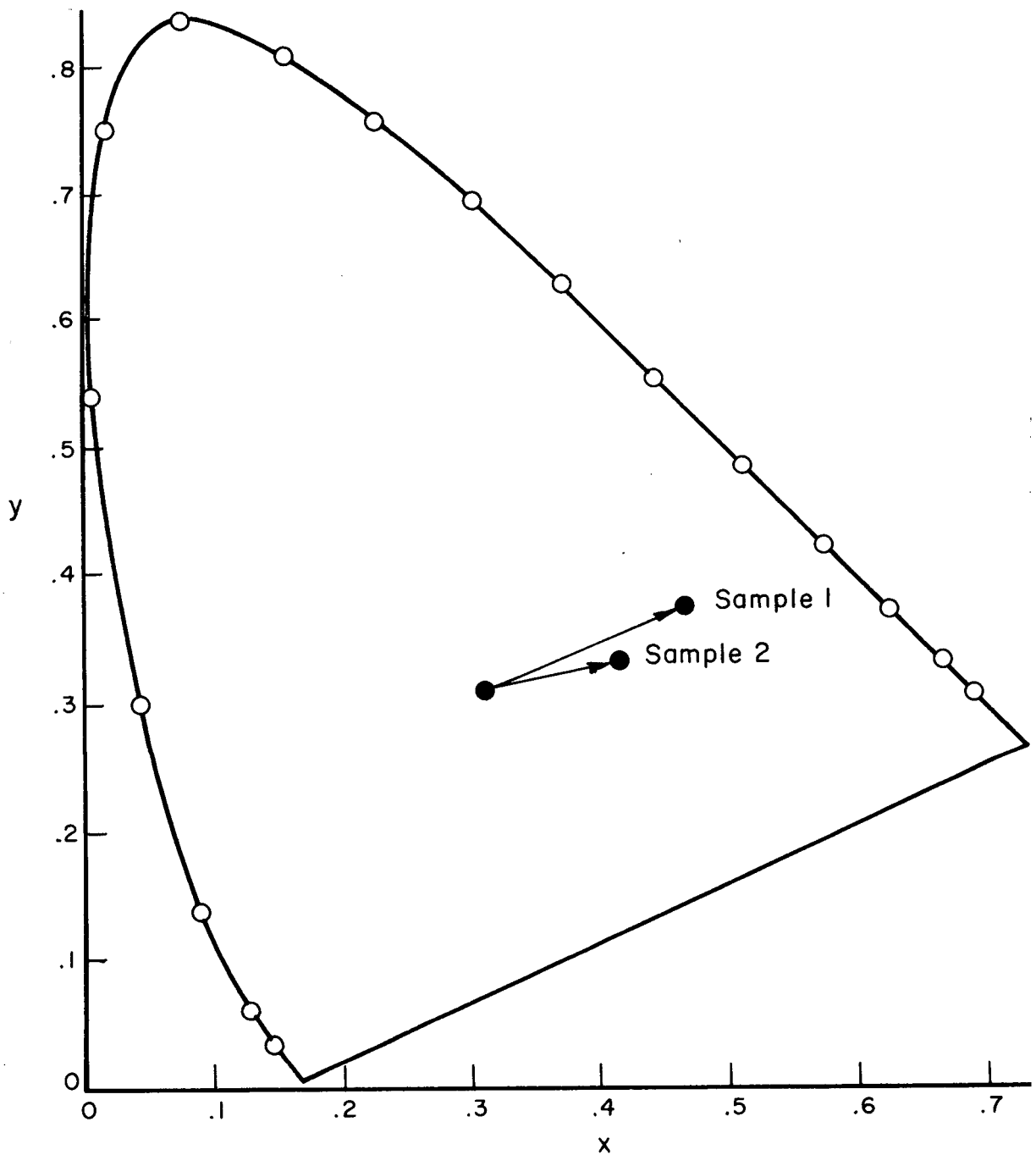

FIGURE 3.21 THE SHIFT IN THE CIE CHROMATICITY COORDINATES OF A PAIR OF METAMERIC COLORS PRODUCED BY CHANGING FROM CIE STANDARD SOURCE C TO CIE STANDARD SOURCE A

CONFIDENTIAL

CONFIDENTIAL

INSTRUMENTAL METAMERISM is caused by an instrument measuring two different colors as the same. GEOMETRIC METAMERISM occurs when the colors of two samples match at one viewing angle, but not at another viewing angle. Geometric metamerism is usually caused by differences in the surface texture or internal structure of the colorant layer.

Metamerism is not expected to be a problem for photointerpreters who are viewing color imagery on a light table illuminated by a white light that is composed of all the different wavelengths in the visible spectrum. However, if the illumination source used for the light table creates white light by combining only a few nearly monochromatic colors, then metamerism may occur.

3.4.5 Color Differences and Tolerances

In general, all members of a group of color-matching experts will not agree that a color match exists between two identical samples. Furthermore R. M. Evans (Evans, 1948) estimates that a perfect match between two colors by an average color-normal observer would probably be unsatisfactory for 90 percent of all other observers.

Because of the obvious commercial importance of specifying the tolerance of variance from an items standard color before it is unacceptable to the customer, many methods have been developed for specifying and calculating the perceptual differences between colors. In principle, all methods determine the perceptual difference between the two colors in a manner similar to the way the geometrical distance between two points is determined. Similarly, the various color-difference formulas can be used to calculate the "perceptual distance" between two points, i.e., two colors, in a color space. For example, the conspicuousness of two colors (color conspicuity) may be defined as the magnitude of this perceptual distance between two colors. The size of the units that are used to express the "perceptual distance" between any two colors is usually selected so that one unit of perceptual distance in a color space represents a just-perceptible or half-the-time observance difference between two colors. On the 1931 CIE chromaticity diagram an elliptically shaped figure is formed by the locus of the points that represent those colors that differ from a given color by a given number of these color-difference units. For example, the ellipses in Figure 3.22 represent some of the color-discrimination ellipses that have been published. (MacAdam, 1942; MacAdam, 1971).

Color-difference formulas used to calculate the perceptual difference between two colors can be applied to interpreting aerial color photography. The various color-difference formulas could be used to set

CONFIDENTIAL

CONFIDENTIAL

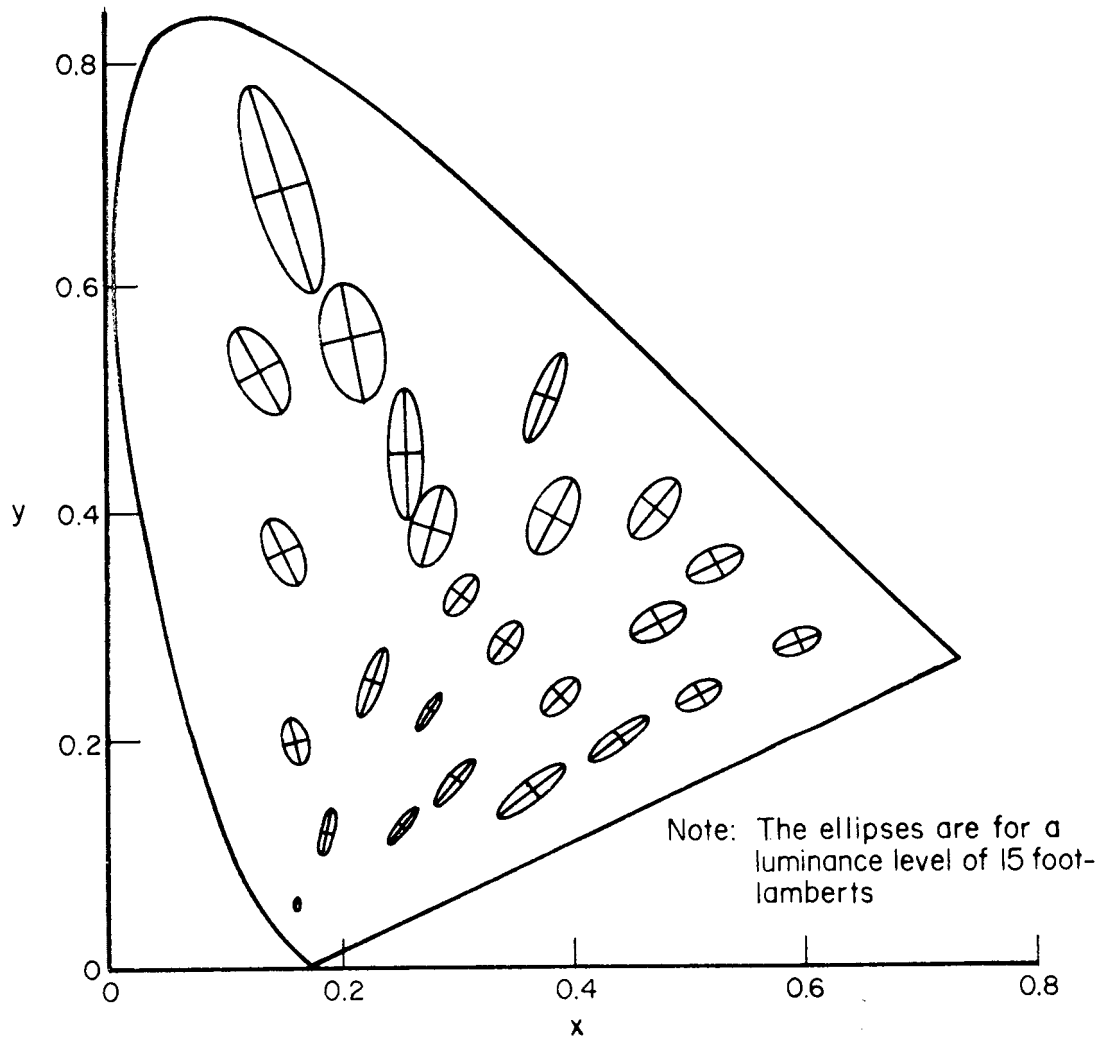

FIGURE 3.22 THE STANDARD DEVIATIONS OF COLOR MATCHES BY OBSERVER PGN, ENLARGED TEN TIMES ON THE 1931 CIE x, y CHROMATICITY DIAGRAM (Mac Adam, 1942)

CONFIDENTIAL

~~CONFIDENTIAL~~

the permissible working tolerances for each step of the acquisition, processing, and viewing cycle used in aerial color photography. For example, the various color-difference formulas could be used to determine both the magnitude and direction in which the color of an image would shift if there were a change in the spectral distribution of the lamp used in the viewing table. Thus the standards for lamps that were acceptable for light table use might be specified as plus or minus so many color-difference units (see also: Section 3.4.6). The second and perhaps the most important application of the concept of color differences to aerial color photography might be in the area of color contrast or target conspicuity. The conspicuity of a target increases with the color difference that exists between the target and its background, and the color contrast of a target could be given as so many perceptual steps or so many color-difference units.

3.4.6 Color Rendering and Color-Rendering Indices

The term color rendering is used here as a general expression for the effect on the color appearances of objects in conscious or sub-conscious comparison with their color appearance under a reference light source versus another light source. In this context the color-rendering properties of a given light source are specified by a COLOR RENDERING INDEX which is a measure of the degree to which, under specified conditions, the perceived colors of objects illuminated by a light source conform to the same objects illuminated by the reference source. (Wyszecki and Stiles, 1967). Thus, the color-rendering indices are intended to be an aggregate measure of the overall color shifts that may occur when imagery is illuminated by light from a nonreference light source.

3.5 COLOR DENSITOMETRY

The color densitometer is the basic measuring instrument used for collecting data for studying the various relationships between image colors and factors that control them. The red, blue, and green optical densities that are measured are related to the combined optical effect produced by the cyan, magenta, and yellow dyes deposited to form the image. These optical densities can be used to determine the overall color balance of imagery or to determine if any color shifts have occurred in the processing. The construction of a typical color densitometer is illustrated in Figure 3.23.

~~CONFIDENTIAL~~

CONFIDENTIAL

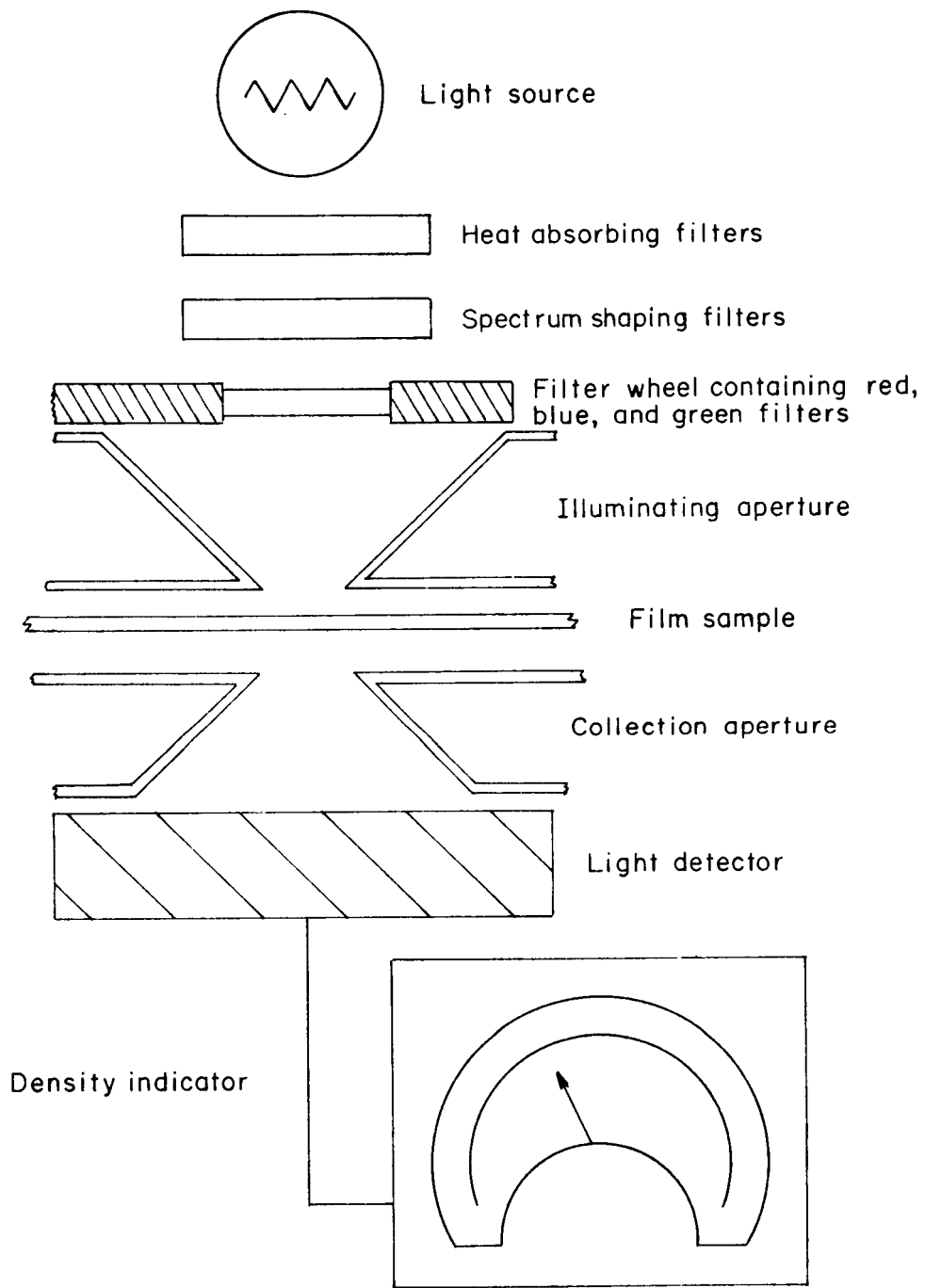

FIGURE 3.23 A SCHEMATIC DIAGRAM OF A TYPICAL COLOR DENSITOMETER

CONFIDENTIAL

CONFIDENTIAL

3.5.1 Specular and Diffuse Density

A color densitometer may be designed to measure either SPECULAR or DIFFUSE DENSITY. The particular density measured by a densitometer is determined by both the degree of collimation of the light used to illuminate the sample and by the size of the SOLID ANGLE for which the collection aperture accepts light that has either passed through the sample or has been reflected from the sample.

If the incident light is highly collimated and the collection angle is small, then the densitometer will measure SPECULAR density. If the incident light is not highly collimated and the sampling aperture subtends a large solid angle, the instrument will measure DIFFUSE density. Most standard color densitometers, such as the Macbeth RD-102 and RD-100 measure diffuse density, whereas microdensitometers, such as the Joyce-Lobel, measure specular density. The values for the specular and diffuse densities of the same image can be quite different. This difference is determined by optical properties, i.e., scattering and absorption, of the image-forming materials. For example, the difference between specular and diffuse density is much greater for images composed of clumps of silver particles than it is for DIAZO images that are composed of dye molecules.

3.5.2 Analytical and Integral Densitometry

Color densitometry may be ANALYTICAL or INTEGRAL. Analytical densitometry is done to determine the properties of the individual colorants that are used to form the image, and integral densitometry measures integrated spectral properties of the image without reference to the individual colorants that compose the image. For example, integral densitometry would be used to determine how much the density of a red image changes when the processing temperature is increased by a half of a degree. For this same experiment, analytical color densitometry would be used to determine the change in relative quantities of the yellow and magenta dyes deposited to form a red image. The particular subdivisions of both integral and analytical densitometry are discussed below.

Five types of densities are measured in integral color densitometry:

- (1) INTEGRAL PRINTING DENSITIES are measured with a color densitometer whose response approximates the photographic response of the printing or duplicating material onto which the original image will be copied. Often, the response of

CONFIDENTIAL

CONFIDENTIAL

REF ID: A66799

the densitometer can not be adjusted to approximate the photographic response of the printing or duplicating material. In this event, the integral printing densities are calculated by substituting the measured values for the red, green, and blue densities of the image into a set of linear equations. The coefficients for these equations are determined by combining information on the sensitometric properties of the duplication material and the spectral characteristics of the filters in the densitometer.

- (2) COLORIMETRIC DENSITIES are measured for final images rather than intermediates in a photographic duplication process. For example, the densities of images on a direct-reversal amateur motion picture film should be expressed as colorimetric densities. In measuring the colorimetric density of an image, the response of the densitometer should duplicate the colorimetric response of the CIE standard observer (See also 3.4.1.2).
- (3) VISUAL or LUMINOUS DENSITIES can be used to compare the density of images even though their colors may be different. For example, the difference between the measured values for the visual densities of two images indicates which of these two images would appear to be lighter to the CIE standard observer. In measuring the visual density of an image, the response of the densitometer should approximate the photopic, i.e., \bar{y} response of the CIE standard observer.
- (4) ARBITRARY THREE-FILTER DENSITIES are measured by using a densitometer whose response is not related to any color or density-measuring convention. Any combination of filters and phototubes may be selected on the basis of cost and stability rather than any particular optical properties they might have. Arbitrary three-filter densitometers are usually used for production testing and quality-control work in which the only interest is in detecting day-to-day changes in the density of the product and not in relating the density measurements to some other density measuring convention.

CONFIDENTIAL

~~CONFIDENTIAL~~

- (5) INTEGRAL SPECTRAL DENSITIES are measured at specific wavelengths by using a series of nearly monochromatic light sources in the densitometers. For example, the 435.8-nanometers (blue) and 546.1-nanometers (green) lines of the mercury spectrum are often used in conjunction with the 643.8-nanometers (red) line of the cadmium spectrum. These measured values for the optical density of an image at well-defined wavelengths are a set of data that can be related to the fundamental photographic characteristics of that particular film.

The object of ANALYTICAL COLOR DENSITOMETRY is to provide data that can aid the photoscientist in determining the behavior of the individual colorants used to form the images in color films and papers. Three types of analytical densities from which this type of data can be extracted are the following:

- (1) SPECTRAL ANALYTICAL DENSITIES are used to denote the optical density of an individual colorant at a particular wavelength. Spectral analytical densities cannot be measured directly because each of the colorants used in color photography has some optical absorption throughout the visible spectrum. Nevertheless, the spectral analytical density of an image can be calculated by using the values for the integral spectral densities of the image. This calculation of the spectral analytical densities assumes that optical densities of the different colorants are additive and that the colorants are present in the same ratio for all density levels. If both these conditions hold, then the spectral analytical densities for the colorants forming an image can be calculated from a set of linear equations and the measured values for integral spectral densities of that image.
- (2) EQUIVALENT NEUTRAL DENSITIES of a colorant used in a subtractive color process are defined as the visual or luminance density it would have if it were converted to a neutral gray by adding to it the just-required amounts of the other colorants used in the process. For example, an image composed of only a magenta dye deposit would have an equivalent neutral density of 1.0 if it could be converted to a 1.0 neutral density absorber by adding to it the appropriate

~~CONFIDENTIAL~~

CONFIDENTIAL

quantities of the cyan and yellow dye used in that particular color process. The concept of equivalent neutral densities is quite useful in indicating how well the color balance of a particular photographic material is maintained over a wide range of exposure levels.

- (3) EQUIVALENT NEUTRAL PRINTING DENSITIES of colorants are defined as the printing densities of neutral colorants that would be matched by adding to colorants the proper amount of the other colorants so that their combination will form three equal red, blue, and green printing densities. Equivalent neutral printing densities are used to specify the density of color negative films or separation negatives that are to be duplicated by printing them on another photographic material.

Although the subject of color densitometry may appear to be both difficult and confusing, it has been thoroughly studied and well reported. Today's solid-state electronics and other optical equipment provides the photoscientist with equipment that is more than adequate for most of his needs. Nevertheless, much of the confusion surrounding color densitometry is usually caused by not understanding what is being measured and by improper use of the instruments. The Center's effort in this area should be to educate the personnel who might use color densitometers or similar equipment to understand the limitations of these instruments and to know what pitfalls might hamper their proper operation.

CONFIDENTIAL

~~CONFIDENTIAL~~

3.6 REFERENCES

- Beresford, J., "Instrumental Measurement of Colour", Journal of Oil Colour Chemistry Association, 53(9), pp. 800-820 (1970).
- Berger, A. and Biockes, A., "The Accuracy of Tristimulus Colorimeters When Measuring Metameric Pairs of Dyings", Color Engineering, 5(3), pp. 34-39 (1967).
- Billmeyer, F. W., Jr., "Comparative Performance of Color-Measuring Instruments", Applied Optics, 8(4), pp. 775-783 (1969).
- Billmeyer, F. W., Jr., "Current American Practice in Color Measurement", Applied Optics, 8(4), pp. 737-750 (1969).
- Billmeyer, F. W., Jr. "Metamerism - An Introduction", Color Engineering, 5(3), pp. 26-27 (1967).
- Billmeyer, F. W., Jr. and Saltzman, M., Principles of Color Technology, 1st ed., Interscience Publishers, New York (1966).
- Billmeyer, F. W., Jr., "Precision of Color Measurement With the GE Spectrophotometer", Journal of the Optical Society of America, 55(6), pp. 707-717 (1965).
- Burnham, R. W., Hanes, R. M., and Bartleson, C. J., Color: A Guide to Basic Facts and Concepts, Wiley, New York, New York (1963).
- Davidson, H. R. and Friede, E., "The Size of Acceptable Color Difference", Journal of the Optical Society of America, 43(7), pp. 581-589 (1953).
- Dekerf, J.L.F., "Accuracy of Tristimulus Computations", Journal of the Optical Society of America, 48(5), pp. 334-338 (1958).
- Evans, R. M., Hanson, W. T., and Brewer, W. L., Principles of Color Photography, John Wiley and Sons, New York (1953).
- Evans, R. M., An Introduction to Color, 1st ed., John Wiley and Sons, New York (1948).
- Erhart, F. H., ed., Principles of Color Sensitometry, 2nd ed., Society of Motion Picture and Television Engineers, New York (1963).
- Garra, A. A. and Briggs, S. J., "Image Interpretation State-of-the-Art Review", The Boeing Company, Aerospace Group, Seattle, Washington (1970).

~~CONFIDENTIAL~~

CONFIDENTIAL

Gourley, J., Rib, H. T., and Miler, R. D., "Automatic Technique for Abstracting Color Description From Aerial Photography", *Photographic Science and Engineering*, 12(1), pp. 27-35 (1968).

Granville, W. C., "Metamerism - A Historical Essay", *Color Engineering*, 5(3), pp. 28-33 (1967).

Hunt, R.W.G., "Objectives in Colour Reproduction", *Journal of Photographic Science*, 18(6), pp.205-215 (1970).

Hunt, R.W.G., The Reproduction of Colour, 2nd ed., Fountain Press, London (1967).

Ingle, G. W., Stockton, F. D., and Hemmendinger, H., "Analytic Comparison of Color Difference Equations", *Journal of the Optical Society of America*, 52(9), pp. 1075-1077 (1962).

James, T. H., ed., *Theory of the Photographic Process*, 3rd ed., MacMillan Company, New York (1966), "The Sensitometry of Color Films and Papers", (J. L. Simonds) pp. 450-463.

Johnston, R., "Geometric Metamerism", *Color Engineering*, 5(3), pp. 42-47 (1967).

Judd, D. B., "Ideal Color Space", *Color Engineering*, 8(2), pp. 37-52 (1970).

Judd, D. B. and Wyszecki, G., *Color in Business, Science, and Industry*, 2nd ed., John Wiley and Sons, New York (1963).

Judd, D. B., Chamberlin, G. J., and Haupt, G. W., "Ideal Lovibond Color System", *Journal of the Optical Society of America*, 52(7), pp. 813-819 (1962).

Judd, D. B. and Kelly, K. L., *The ISCC-NBS Method of Designating Colors and a Dictionary of Color Names*, National Bureau of Standards Circular 553 (1955).

Judd, D. B., "Reduction of Data on Mixture of Color Stimuli", *Bureau of Standards Journal of Research*, 4, pp. 515-548 (1929).

Little, A. C., "Evaluation of Single - Number Expressions of Color Difference", *Journal of the Optical Society of America*, 53(2), pp. 293-296 (1963).

CONFIDENTIAL

~~CONFIDENTIAL~~

MacAdam, D. L., "Geodesic Chromaticity Diagram Based on Variances of Color Matching by 14 Normal Observers", Applied Optics, 10(1), pp. 1-7 (1971).

MacAdam, D. L., "Color Science and Color photography", Physics Today, 20(1), pp 27-39 (1967).

MacAdam, D. L., "Visual Sensitivities to Color Differences in Daylight", Journal of the Optical Society of America, 32(5), pp. 247-274 (1942).

MacAdam, D. L., "Subtractive Color Mixture and Color Reproduction", Journal of the Optical Society of America, 28(12), pp. 466-480 (1938).

MacAdam, D. L., "Photographic Aspects of the Theory of Three-Color Reproduction", Journal of the Optical Society of America, 28(11), pp. 399-418 (1938).

McCarley, J. E., Green, C. E., and Horowitz, K. H., "Digital System for Converting Spectrophotometric Data to CIE Coordinates, Dominant Wavelength, and Excitation Purity", Journal of the Optical Society of America, 55(4), pp. 355-360 (1965).

Miller, C. W., "The Matrix Algebra and Color Reproduction", Journal of the Optical Society of America, 31(7), pp. 477-482 (1941).

Mudd, J. S. and Woods, M., "Colour and Difference Measurement", Journal of the Oil Colour Chemistry Association, 53(10), pp. 852-875 (1970).

Newhall, S. M., Nickerson, D., and Judd, D. B., "Final Report of the O.S.A. Subcommittee on the Spacing of the Munsell Colors", Journal of the Optical Society of America, 33(7), pp 385-418 (1943).

Nickerson, D. and Jerome, C. W., "Color Rendering of Light Sources: CIE Method of Specification and its Applications", Illuminating Engineering, 60(5), pp. 262-271 (1965).

Nimeroff, I., Colorimetry, National Bureau of Standards Monograph 104 (1968).

Nimeroff, I., "Comparison of Uncertainty Ellipses Calculated From Two Spectrophotometric Colorimetry Methods by an Automatic-Computer Program", Journal of the Optical Society of America, 56(2), pp. 230-237 (1966).

~~CONFIDENTIAL~~

~~CONFIDENTIAL~~

Nimeroff, I. and Yurow, J. A., "Degree of Metamerism", Journal of the Optical Society of America, 55(2), pp. 185-190 (1965).

Nimeroff, I., Rosenblatt, J. R., and Danneniller, M. C., "Variability of Spectral Tristimulus Values", Journal of the Optical Society of America, 52(6), pp. 685-691 (1962).

Nimeroff, I., "Propagation of Errors in Tristimulus Colorimetry", Journal of the Optical Society of America, 47(8), pp. 697-702 (1957).

Nimeroff, I., "Propagation of Errors in Spectrophotometric Colorimetry", Journal of the Optical Society of America, 43(6), pp. 531-533 (1953).

Onley, J. W., "Analytical Densitometry for Color Print Evaluation", Journal of the Optical Society of America, 50(2), pp. 177-182 (1960).

Powers, S. A. and Miller, I. E., "Pitfalls of Color Densitometry", Photographic Science and Engineering, 7(1), pp. 59-67 (1963).

Rheinboldt, W. C. and Menard, J. P., "Mechanical Conversion of Colorimetric Data to Munsell Rentations", Journal of the Optical Society of America 50(8), pp. 802-807 (1960).

Richter, M., "The Official German Standard Color Chart", Journal of Optical Society of America, 45(3), pp. 223-226 (1955).

Robertson, A. R., "Colorimetric Significance of Spectrophotometric Errors", Journal of the Optical Society of America, 57(5), pp. 691-698 (1967).

Robertson, A. R. and Wright, W. D., "International Comparison of Working Standards for Colorimetry", Journal of the Optical Society of America, 55(6), pp. 694-706 (1965).

Sant, A. J., "Procedures for Equivalent-Neutral-Density (END) Calibration of Color Densitometers Using a Digital Computer", Photographic Science and Engineering, 14(5), pp. 356-362 (1970).

Stiles, W. A. and Wyszecki, G., "Counting Metameric Object Colors", Journal of the Optical Society of America, 52(3), pp. 313-328 (1962).

Yule, J.A.C., "The Theory of Subtractive Color Photography, I. The Conditions for Perfect Color Rendering", Journal of the Optical Society of America, 28(11), pp. 419-430 (1938).

~~CONFIDENTIAL~~

~~CONFIDENTIAL~~

Yule, J.A.C., "The Theory of Subtractive Color Photography, II. Prediction of Errors in Color Rendering Under Given Conditions", Journal of the Optical Society of America, 28(12), pp. 481-492 (1938).

• Wyszecki, G., "On Projective Transformations of the CIE-Chromaticity Diagram", Journal of the Optical Society of America, 46(11), pp. 982-986 (1956).

- Wyszecki, G., "Propagation of Errors in Colorimetric Transforms", Journal of the Optical Society of America, 49(4), pp. 389-393 (1959).

Wyszecki, G., "Recent Agreements Reached by the Colorimetry Committee of the Commission Internationale de l'Eclairage", Journal of the Optical Society of America, 58(2), pp. 290-292 (1968).

Wyszecki, G., "Optical Resource Letter on Colorimetry", Journal of the Optical Society of America, 59(2), pp. 123-125 (1969).

Wyszecki, G. and Stiles, W. S., Color Science, 1st ed., John Wiley and Sons, New York (1967).

~~CONFIDENTIAL~~

CONFIDENTIAL

4.0 COLOR AERIAL PHOTOGRAPHY

4.1 COLOR-FILM THEORY

A knowledge of the principles and concepts of color photography will be more useful to the image interpreter as a communication tool than as an aid in helping him find and identify more targets in a shorter period of time. The basic theory of color photography is not of great interest to the image interpreter, because he is concerned primarily with imagery and not with all the other aspects of small-scale, high-resolution color photographs. Therefore, the physical properties and photographic characteristics of color films and how these properties and characteristics are related and manipulated are of little use to the interpreter. Nevertheless, a significant portion of an image interpreter's time is spent communicating with those individuals and organizations that levy requirements on him and that supply support services to him. If an interpreter can clearly communicate his film-related needs and problems to these individuals and organizations, they can probably perform their jobs more efficiently and productively.

Although the following discussion of the construction of color films and the physical properties used in the design of these films is limited to high-resolution, color-reversal* acquisition films, such as Eastman Kodak's SO-255, the general principles that are discussed are applicable to a great variety of color films. It is assumed in the following discussion of color-film theory that the reader is familiar with the subtractive process of color reproduction as explained in Section 3.2.2 of this report. Thus, the main emphasis is placed on the formation of cyan, magenta, and yellow dyes in proper proportion and location in the film, rather than why the dyes are used for a color film.

The general configuration of a color film is shown in Figure 4.1. A typical color film consists of a "tripack" or three-layer emulsion coated on a chemically suitable and dimensionally stable base such as glass or mylar. Each layer of the tripack contains both light-sensitive, image-forming SILVER HALIDE materials and nonlight-sensitive, color-forming materials dispersed in a gelatin-based carrier. This dispersion of materials in the gelatin carrier is indicated by the small squares and circles in the figure. The light-sensitive, image-forming silver halide materials in each layer of the tripack are chemically sensitized so that they respond only to light from a desired part of the visible spectrum. Similarly, the color-forming materials or DYE COUPLERS in each layer of the tripack emulsion produce only a dye of a single color when they are

* Color-reversal films produce a positive color image of the scene to which they were initially exposed.

CONFIDENTIAL

CONFIDENTIAL

95

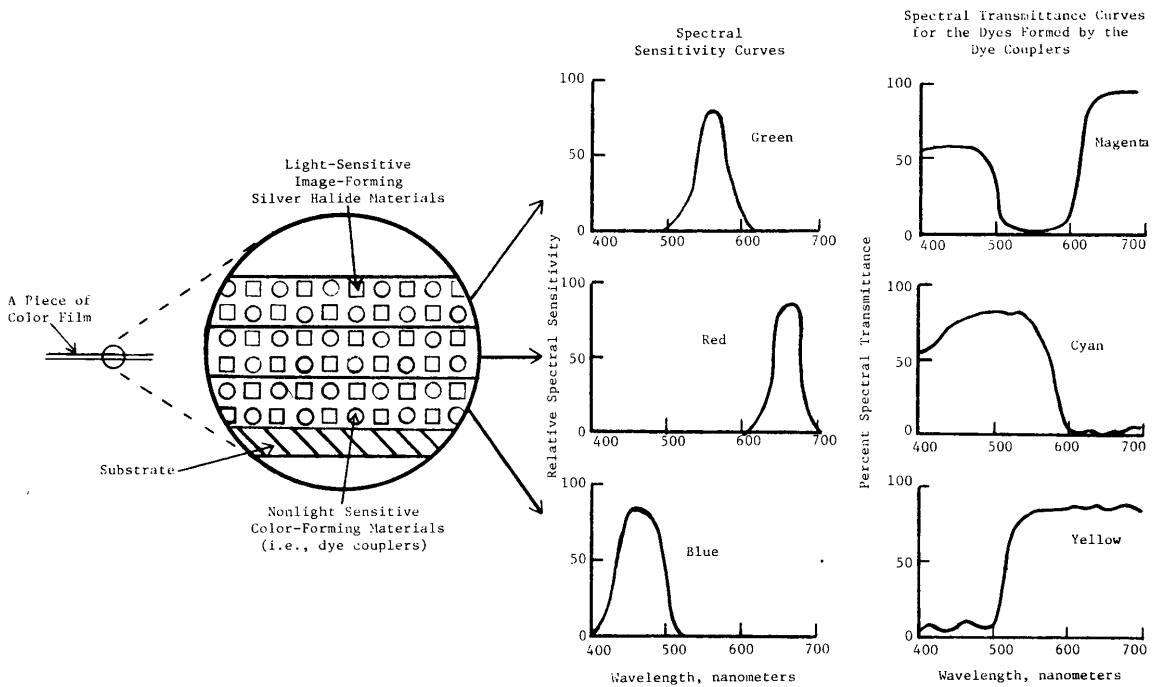

FIGURE 4.1 THE CONFIGURATION OF A TYPICAL COLOR FILM

CONFIDENTIAL

NPIC/R-03/72

CONFIDENTIAL

activated during development. The spectral-sensitivity curves for the light-sensitive, image-forming silver halide materials and the spectral transmittance curves for the colors resulting from a given concentration of dye are shown on the right side of the figure. Note that the color formed by a dye coupler in a given layer is the complementary color* of that to which the image-forming material is sensitive. When an exposure is made, the image-forming silver halide materials in each of the layers respond to their appropriate components in the scene. In this way, the invisible LATENT IMAGE formed in the three layers is a record of the spatial distribution of the various color components in the scene. When the exposed film is developed, these latent images become visible and some of the chemical by-products of this development reaction combine with the dye couplers to form the cyan, magenta, and yellow globules of dye. The amount of dye formed in an area is proportional to the concentration of the developer by-products in that particular region. Before the processing is completed, the silver images that represent the red, blue, and green records of the scene are removed from the tripack emulsion by a chemical bleach that forms a soluble silver compound. A positive dye image of the original scene remains. Thus, this type of color photography consists of using the chemical by-products formed in a development reaction to control the formation of the cyan, magenta, and yellow dyes.

Although the basic concept can be applied to either negative-working or positive-working films, the following discussion is limited to the color-reversal films. The image colors produced by a negative-working film are the COMPLEMENTARY colors of those in the original scene. For example, green marking on the tail of an aircraft will appear as green on a color-reversal film, and as magenta (the complement of green) on a negative-working film.

The physical configuration of a color-reversal film is illustrated at the top of Figure 4.2. The small squares indicate the light-sensitive image-forming silver halide materials and the small circles indicate the nonlight-sensitive color-forming materials which are dispersed in each layer of the tripack emulsion. The spectral-sensitivity region of each emulsion layer is shown at the top right of the drawing and the colors of the dye formed when the dye couplers are activated is shown at the top left of the drawing. The following discussion of the formation of the colored image in a color-reversal material begins with the exposure of the film in an image-forming optical system, e.g., a camera, and concludes with the formation of the dye image that is ready for use by the image interpreter.

* Complementary colors are pairs of colors, which when mixed in suitable proportions, match some agreed upon achromatic color.

CONFIDENTIAL

ORIGINAL SCENE



Dye color

Exposure and latent image formation-Step 1

Spectral sensitivity

Magenta
Cyan
Yellow

Green
Red
Blue

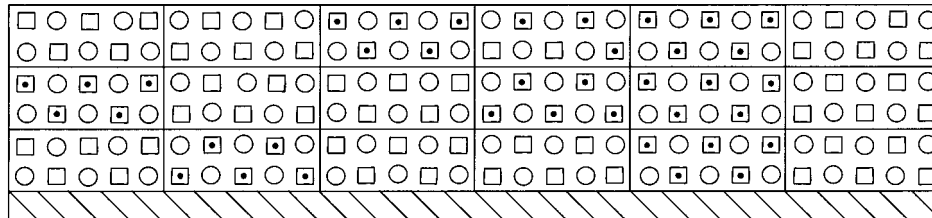

Black and White development - Step 2

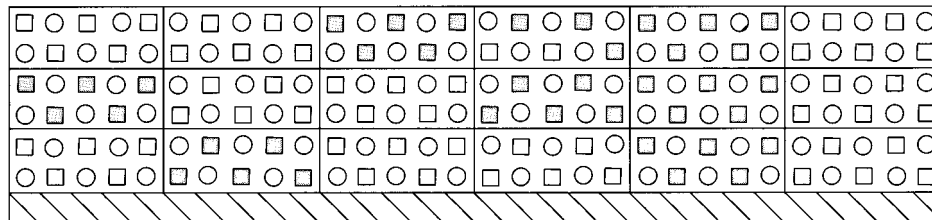

Color development - Step 3

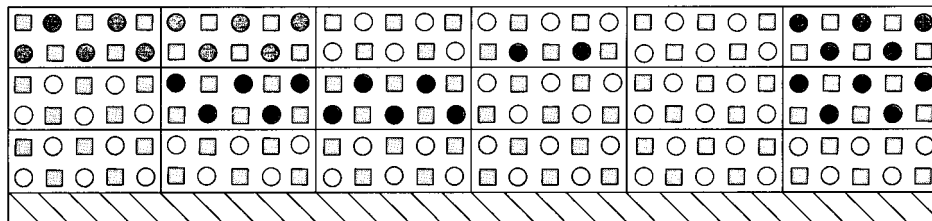

Bleach and stabilization - Step 4

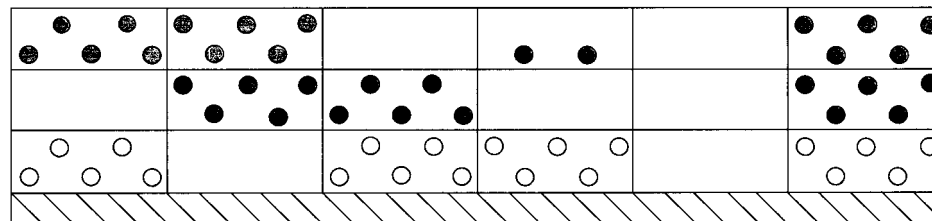

Reproduction of original scene



FIGURE 4.2 THE FORMATION AND DEVELOPMENT OF A COLORED IMAGE IN A COLOR-REVERSAL PHOTOGRAPHIC PROCESS.

CONFIDENTIAL

It is assumed that the film is exposed in a camera that is focused on the colored target shown at the top center of Figure 4.2. The latent images that are formed as a result of this exposure to ACTINIC LIGHT are indicated by the small black dots inside the small squares. These images are formed as a result of a photochemical reaction between the incident light and the image-forming silver halide materials. The number of metallic silver nuclei contained in each of the latent images is proportional to the effective exposure received by that particular area of the emulsion. The latent images formed in the three layers of the emulsion record the spatial distribution of the red, blue, and green colors of the objects in the scene. For example, the latent images that were formed in the red-sensitive middle layer of the tripack emulsion is the record of the spatial distribution of the red component of the red, orange, and white colored areas of the target. Similarly, the latent images that were formed in the blue- and green-sensitive layers are the records of the blue and green colors of the various target areas. A latent image is formed in each layer of the tripack emulsion which corresponds to the red, blue, and green components of the light coming from the white target. For example, the latent images of the orange target shown in Figure 4.2 appear in both the red- and green-sensitive layers of the tripack emulsion; this composite latent image of the orange-colored target contains many more silver particles in the red-sensitive layer than it does in the green sensitive layer. In a similar manner, the spatial distribution of all the colors in the scene are recorded as latent images in the three layers of the tripack emulsion. In order for these latent images to be useful to the interpreter, they must be rendered visible by processing them in the appropriate chemical solutions.

The exposed film is processed in a conventional black and white developer. When the exposed film is immersed in the developer, each of the metallic silver nuclei that composed the latent image acts as a catalyst for the development reaction. One of the reaction products is a large cloud of easily visible clumps of metallic silver located at or near the nuclei that initially catalyzed the reaction. The formation of these large clumps of metallic silver is indicated by the black squares shown as following Step 2 (Figure 4.2). If the film is viewed at this stage of development, a negative black and white image of the original scene is seen. The area of the image that corresponds to the black target, being devoid of clumps of silver, appears as a light area when viewing the film in white light. Conversely, the area on the film that corresponds to the white target, being completely filled with clumps of silver, appears as a dark area on the film when viewed in white light. Note that the unblackened squares in the drawing indicate image-forming material not consumed by the development reaction. Also, the uncolored circles indicate that the dye couplers have not reacted in this development step with the chemical by-products of the development reaction to form blobs of cyan, magenta, and yellow dyes.

CONFIDENTIAL

~~CONFIDENTIAL~~

The color-development step (Step 3 in Figure 4.2) is used to create a correctly colored positive dye image from the black and white, negative, silver-based image. After it is rinsed to remove black and white processing chemicals from the emulsion, the partially developed film is placed in a solution of color developer. Some of the chemicals in the color-developer solution react with the image-forming silver halide materials that were not developed by the "black and white" or the first developer. Such a development process is usually called a REVERSAL DEVELOPMENT process because large clumps of metallic silver are now formed in those areas that did not receive actinic light.

The chemical by-products of this reversal development step react with the other chemicals in the color-developer solution and with the dye couplers in the emulsion to form blobs of the appropriate subtractive dyes at or near those areas at which the reversal development produced clumps of metallic silver. The color, concentration, and location of the silver and dye images are shown in the drawing that follows Step 3 (Figure 4.2). The concentration levels of the dye blobs, which are shown as cyan, magenta, and yellow circles in Figure 4.2, are proportional to the concentration levels of the chemical by-product produced by the reversal development.

At this point in the overall development process, the image-forming silver halide material is converted to clumps of metallic silver. This uniformly dense silver image would completely obscure the color-positive dye image in the tripack emulsion. The final steps in developing color-reversal film are to chemically remove all the clumps of silver and unused dye coupler from the emulsion and to chemically stabilize the dyes. The final dye image is shown at the bottom of Figure 4.2. When this image is viewed over white light, the effects of the various dye layers combine to reproduce the proper target colors.

4.2 PHOTOGRAPHIC PROPERTIES OF SELECTED AERIAL FILMS

4.2.1 Color Films

Table 4.1 is a listing of selected photographic properties of some aerial color films that might be of interest. The basic photographic theory of these types of materials is discussed in Section 4.1 COLOR-FILM THEORY. (Smith, 1968; and Eastman Kodak Publication M-70).

~~CONFIDENTIAL~~

TABLE 4.1 THE PHOTOGRAPHIC CHARACTERISTICS OF SELECTED AERIAL COLOR FILMS

| Film Name | Manufacturer Film Number | Film Description and Application | Aerial Exposure Index | Resolving Power, lines/mm | | | Processing |
|------------------------------------------|-------------------------------------------------------|--------------------------------------------------------------------------------------------------------------------------------------------------------|-----------------------------|---------------------------|-------|--------------------|----------------------------------|
| | | | | 1000:1 | 1.6:1 | RMS Granularity | |
| Aerocolor Negative | Eastman Kodak; 2445 | High-speed color negative film for mapping and reconnaissance | 32 | 80 | 40 | 14 | Aero-Neg Color Process |
| Ektachrome HS Aero- graphic | Eastman Kodak; 2448 | Color-reversal film for low to medium altitude aerial mapping and reconnaissance | 6 | 80 | 40 | 12 | EA-4; EA-5 |
| Aerial Color | Eastman Kodak; SO-242 | Slow-speed, high-resolution film for high-altitude reconnaissance | 2 | 200 | 100 | 11 | Kodak Process ME-4 (modified) |
| Aerial Color | Eastman Kodak; SO-255 | Similar to SO-242; ultra-thin base for maximum spool capacity; high-resolution film for high-altitude reconnaissance | 2 | 200 | 100 | 11 | Kodak Process ME-4 (modified) |
| Ekachrome EF Aerographic | Eastman Kodak; SO-397 | High-speed, color-reversal film for aerial mapping and reconnaissance | 12 | 63 | 32 | 15 | EA-4; EA-5 |
| Aerochrome EF | Eastman Kodak; SO-154 | Similar to SO-397 | 12 | 63 | 32 | 15 | EA-4; EA-5 |
| Ansochrome | General Aniline and Film Corporation; D 200 | High-speed, high-contrast color reversal film for aerial photography | 30 | 125 | 45 | 25 | GAF AR-1 |
| Ansochrome | General Aniline and Film Corporation; D 500 | Very high-speed, high-contrast color reversal film and aerial photographs | 75 | 100 | 40 | 50 | GAF AR-1 |
| Aerial Ektachrome R Print | Eastman Kodak; SO-118 | Low-contrast, color-reversal film for making duplicate transparencies from aerial Ektachrome and Aerochrome film originals | Not applicable | 100 | 50 | 9 | EA-4; EA-5 |
| Aerial Color Duplicating | Eastman Kodak; SO-271 | High-contrast, color reversal film for making duplicate transparencies from aerial Ekachrome and Aerochrome film originals | Not applicable | 80 | 50 | 8.5 | EA-5; EA-4 |
| Ektachrome Aerographic Duplicating | Eastman Kodak; SO-360 | Low-contrast, color-reversal film for making duplicate transparencies from aerial Ektachrome and Aerochrome film originals; high dimensional stability | Not applicable | 125 | 63 | 8 | EA-5 |
| Ansochrome Duplicating Film | General Aniline and Film Corporation; T-6470 | A duplicating film for duplicating Ansochrome D 200 and D 500 color aerial film | Not applicable | -- | -- | -- | -- |
| Ansochrome Duplicating Film | General Aniline and Film Corporation; T-7470 | Similar to T-6470, except for a different base material | Not applicable | -- | -- | -- | -- |

CONFIDENTIAL

100

CONFIDENTIAL

NPIC/R-03/72

CONFIDENTIAL

4.2.2 False-Color Films

FALSE COLOR or CAMOUFLAGE DETECTION color film is another type of color aerial film that may be of interest to the image interpreter because of its possible future use for solving very special and unique detection and identification problems (see 5.1.3.2 Color Infrared Film). The concept of false-color aerial film is quite similar to that for color-reversal or "true color" aerial films because for both films, the chemical by-products of a development reaction are used to control the formation of various colored dyes. The difference between false-color films and the true-color films is the spectral response characteristics of each of the individual layers of the tripack emulsion. The true-color films respond to the red, blue, and green portions of the spectrum whereas the false-color films respond to the green, red, and INFRARED* portions of the spectrum**. The spectral sensitivity of each of the false-color films are as follows: the yellow dye-forming layer responds to green light, the magenta dye-forming layer to red light, and the cyan dye-forming layer to "infrared light"***. The colors of objects in imagery that was acquired with false-color film are quite different from their natural color because of the altered spectral response of the dye-forming layers:

- Reds, or combination of colors containing red, turn yellow or predominantly yellowish.
- Greens, or combinations of color predominantly green, turn violet.

* The infrared portion of the spectrum to which false-color film is sensitive extends from approximately 700 to 900 nanometers.

** False-color or camouflage detection film also is sensitive to blue light because the infrared sensitizing dye that is used to sensitize the cyan dye-forming layer also produces a significant amount of blue-light sensitivity in the same layer. A yellow-colored or minus-blue filter used during acquisition absorbs most of the blue light in the image. Thus, the effective sensitivity of the false-color film is in the green, red, and infrared portions of the spectrum.

*** Strictly speaking, infrared radiation is not light, because such long wavelengths fall outside of what is usually considered to be the visual response range of the eye. By common usage those electromagnetic radiations only slightly longer than the longest visible wavelengths are referred to as infrared light.

CONFIDENTIAL

CONFIDENTIAL

- Yellows, or combinations of colors which are predominantly yellow, turn to a near white, often with a faint green cast.
- Blues, or combinations of colors where blue is the predominant color, remain blue, but of a darker shade.
- Browns (burnt umber and sienna brown) turn dark green and light green, respectively.
- Violet and violet-blue-violet turn orange and dark brown, respectively.
- Gray scales appear in varied shades of blue since not all the blue light is filtered out by the yellow filter.

For example, natural vegetation appears as red in imagery that was acquired with a false-color film, because natural vegetation reflects "infrared light" as well as green light. However, objects painted with a green paint that does not reflect a significant amount of infrared wavelengths will appear to be violet on a false-color film. Similarly, a natural brown color, which is a desaturated orange, appears as green. The overall result of false-color imagery is to shift the colors of objects so that manmade targets can be readily distinguished from their natural surroundings. (Smith, 1968).

4.2.3 Spectrazonal or Multispectral Film and Techniques

Spectrazonal or multispectral photography is intended to exploit the unique spectral reflectance properties or color signatures of a given class of targets (see 5.1.3.4 Spectrazonal or Multispectral Techniques). The basic concept is to optically remove all wavelengths except those that are related to a specific type of target. Thus, in theory, spectrazonal photography is a way to increase the color contrast between a target and its background. Spectrazonal or multispectral imagery is acquired by having multiple cameras on the same acquisition platform or multiple lenses on one camera. All lenses are identical as nearly as possible and each is fitted with a filter with a different color (broad band pass or a very narrow band pass depending on target being photographed). For example, of two cameras in use, one might be equipped with a red filter, and the other with a blue filter. Conventional panchromatic, black and white, or silver halide film can be used in both cameras. The multispectral imagery is acquired by simultaneously exposing the film in both cameras to the same scene. Thus, both red and blue records of the scene

CONFIDENTIAL

~~CONFIDENTIAL~~

are obtained. Spectrazonal photography has demonstrated that the targets of interest may be more evident on the film used for one color than on the other colors.

4.2.4 Additive Color Separations

The additive method of aerial color photography has seen very limited use because of the cost and the optical complexity of the 3-camera system, and the 3-projector replay system. The principal features of the additive color reproduction process are discussed in Section 3.2.1 and its problems in Section 5.1.3.3.

4.3 EFFECTS OF TARGET AND ACQUISITION PARAMETERS ON COLOR AERIAL PHOTOGRAPHY AND COLOR PERCEPTION

4.3.1 Colorimetric Properties of Selected Natural and Man-Made Targets

Color coordinates of various targets are tabled so that the Center's personnel can gain some appreciation of where various targets are located in both the CIE and Munsell color space. CIE and Munsell designations for the colors of some selected natural and man-made objects are given in Tables 4.2 and 4.3, respectively, and CIE chromaticity coordinates are plotted in Figure 4.3. Although exceptions exist, the following generalization about these colors can be very helpful in considering the effects of the atmosphere on color imagery. The colors of these selected natural and man-made targets have CIE dominant wavelengths in the 560 to 590 nanometers region of the spectrum and Munsell hues in the green-yellow to yellow-red sector of the Munsell hue circuit. The CIE lightness of many of these colors is less than 30 percent and their corresponding Munsell values are less than 6. The colors of these targets are usually low in saturation, typical CIE excitation purity is less than 50 percent and typical Munsell chroma is less than 3. Thus, the majority of the targets that might appear in color imagery are usually a dull, greenish-brown color. Obviously, there are exceptions to these generalizations. The manner in which the atmosphere distorts both the geometrical shape and color of these targets is discussed in the following section of the report.

~~CONFIDENTIAL~~

CONFIDENTIAL

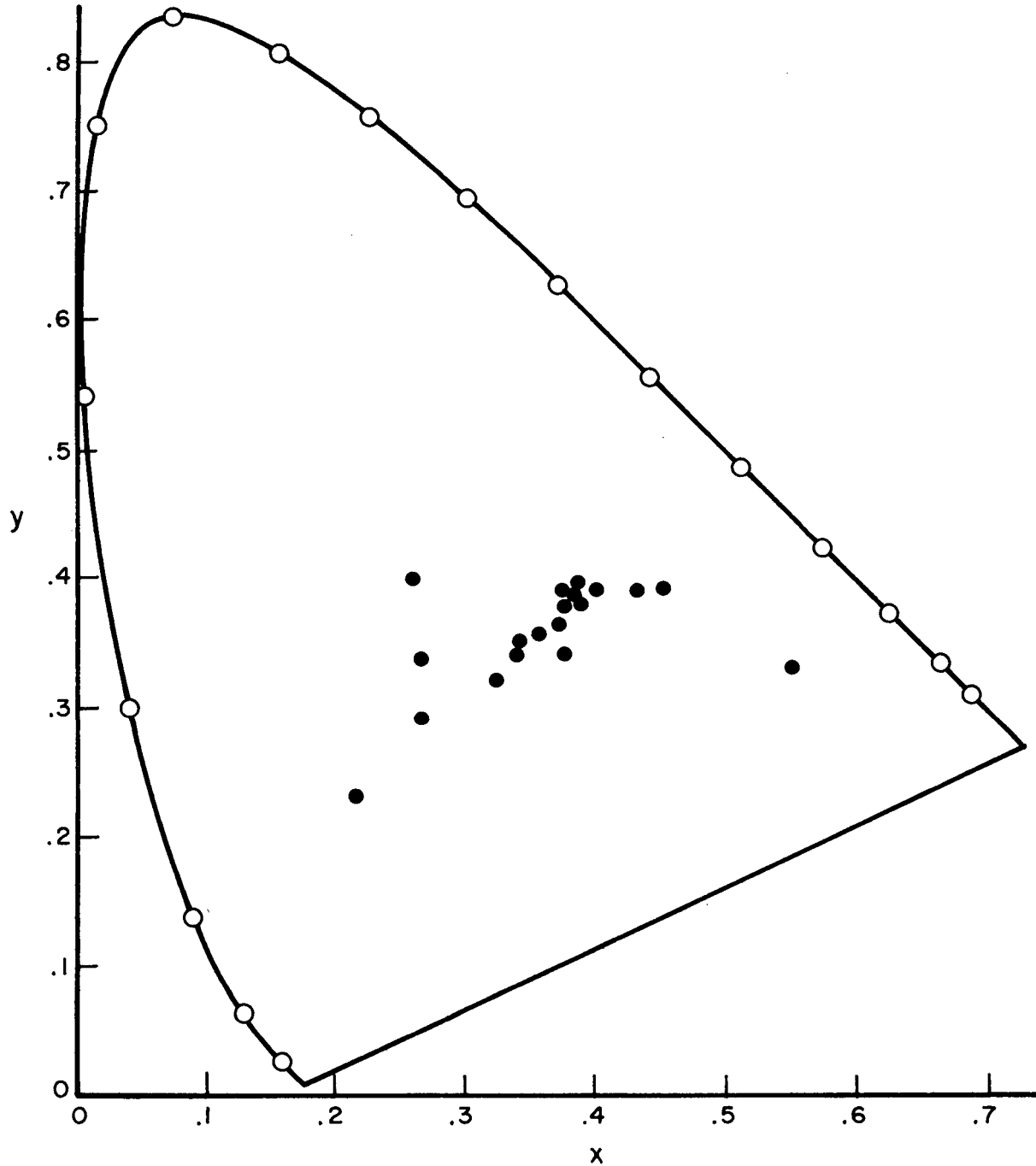

FIGURE 4.3 CIE CHROMATICITY COORDINATES FOR SELECTED NATURAL AND MAN-MADE TARGETS

CONFIDENTIAL

TABLE 4.2 THE CIE CHROMATICITY COORDINATES, LIGHTNESSES, DOMINANT WAVELENGTHS AND EXCITATION PURITIES FOR THE COLORS OF SELECTED NATURAL AND CULTURAL TARGETS

| Type of Sample | Chromaticity Coordinates | | Lightness Value Y, % | Dominant Wavelength λ_d nm | Excitation Purity P_e , % | CIE Standard Source |
|------------------------------------------------------|--------------------------|-------|----------------------|------------------------------------|-----------------------------|---------------------|
| | x | y | | | | |
| 1. Inland water | 0.269 | 0.289 | 5.0 | 481.0 | 31.0 | B |
| 2. Snow, fresh fallen | 0.340 | 0.346 | 77.0 | 481.0 | 3.0 | B |
| 3. Snow, covered with ice | 0.351 | 0.354 | 75.0 | 579.5 | 2.0 | B |
| 4. Limestone, clay | 0.377 | 0.376 | 63.0 | 579.0 | 18.0 | B |
| 5. Mountain tops, bare | 0.399 | 0.387 | 24.0 | 581.6 | 29.0 | B |
| 6. Sand, dry | 0.399 | 0.387 | 24.0 | 581.6 | 29.0 | B |
| 7. Clay, soil, wet | 0.382 | 0.373 | 9.0 | 582.8 | 18.0 | B |
| 8. Ground, bare, rich soil, dry | 0.382 | 0.373 | 9.0 | 582.8 | 18.0 | B |
| 9. Ground, black earth, sand, loam | 0.377 | 0.369 | 3.0 | 583.2 | 15.0 | B |
| 10. Coniferous forest, winter | 0.381 | 0.396 | 3.0 | 574.4 | 25.0 | B |
| 11. Coniferous forest, summer | 0.397 | 0.410 | 8.0 | 575.8 | 36.0 | B |
| 12. Meadow, dry; grass | 0.397 | 0.410 | 8.0 | 575.8 | 36.0 | B |
| 13. Deciduous forest, summer | 0.394 | 0.432 | 10.0 | 571.9 | 43.0 | B |
| 14. Grass, lush | 0.394 | 0.432 | 10.0 | 571.9 | 43.0 | B |
| 15. Deciduous forest, fall | 0.451 | 0.399 | 15.0 | 585.8 | 50.0 | B |
| 16. Field crops, ripe | 0.451 | 0.399 | 15.0 | 585.8 | 50.0 | B |
| 17. Earth roads | 0.377 | 0.369 | 3.0 | 583.2 | 15.0 | B |
| 18. Black top roads | 0.382 | 0.373 | 9.0 | 582.8 | 18.0 | B |
| 19. Buildings | 0.382 | 0.373 | 9.0 | 582.8 | 18.0 | B |
| 20. Wet White Sand, Rodger's Quarry | 0.359 | 0.356 | 21.8 | 580.4 | 23.7 | C |
| 21. Wet Yellowish Quartz Sand, Rodger's Quarry | 0.392 | 0.373 | 21.0 | 582.7 | 37.2 | C |
| 22. Wet Commercial (Zonalite) "Vermiculite" | 0.354 | 0.348 | 16.5 | 582.0 | 20.3 | C |
| 23. Dry White Sand, Rodger's Quarry | 0.350 | 0.349 | 37.7 | 580.3 | 19.5 | C |
| 24. Dry Yellowish Quartz Sand, Rodger's Quarry | 0.373 | 0.363 | 36.9 | 581.6 | 29.4 | C |
| 25. Dry Commercial (Zonalite) "Vermiculite" | 0.337 | 0.337 | 27.7 | 580.0 | 13.0 | C |
| 26. Damp Collington Sandy Loam | 0.349 | 0.345 | 14.9 | 582.0 | 18.0 | C |
| 27. Outer Bark, Scrub Pine (Pinus virginiana, Mill.) | 0.358 | 0.346 | 11.9 | 584.2 | 20.8 | C |
| 28. Inner Bark, Scrub Pine (Pinus virginiana, Mill.) | 0.342 | 0.349 | 14.7 | 586.4 | 25.4 | C |
| 29. Outer Bark, White Oak (Quercus alba, L.) | 0.326 | 0.342 | 27.7 | 571.1 | 11.1 | C |

CONFIDENTIAL

105

CONFIDENTIAL

NPIC/R-03/72

TABLE 4.2 THE CIE CHROMATICITY COORDINATES, LIGHTNESSES, DOMINANT WAVELENGTHS AND EXCITATION PURITIES FOR THE COLORS OF SELECTED NATURAL AND CULTURAL TARGETS (Continued)

| Type of Sample | Chromaticity Coordinates | | Lightness Value Y, % | Dominant Wavelength λ_d nm | Excitation Purity P_e , % | CIE Standard Source |
|--------------------------------------------------------------------------|--------------------------|-------|-------------------------|---------------------------------------|--------------------------------|---------------------|
| | x | y | | | | |
| 30. Inner Bark, White Oak (Quercus alba, L.) | 0.357 | 0.350 | 7.5 | 580.2 | 23.1 | C |
| 31. Chinese Red #6335 Chi-namel Paint, Chi-namel Paint and Varnish Co. | 0.556 | 0.330 | 16.5 | 609.4 | 69.5 | C |
| 32. Colony Yellow #317 House Paint, Lowe Brothers | 0.379 | 0.391 | 68.5 | 576.5 | 38.4 | C |
| 33. Green #173 Tractor Paint, Lowe Brothers | 0.268 | 0.339 | 6.8 | 497.6 | 14.2 | C |
| 34. Red #139 Tractor Paint, Lowe Brothers | 0.514 | 0.321 | 10.7 | 613.2 | 55.8 | C |
| 35. Royal Blue Permanent Trim Paint, John W. Masury & Son | 0.221 | 0.234 | 10.0 | 478.8 | 41.6 | C |
| 36. Seal Brown Supreme House Paint, John W. Masury & Son | 0.378 | 0.343 | 8.2 | 590.3 | 25.4 | C |
| 37. Verdi Green #6830 Super House Paint, Chi-namel Paint and Varnish Co. | 0.256 | 0.400 | 30.7 | 511.1 | 18.6 | C |
| 38. Khaki #1 (cotton) | 0.368 | 0.366 | 24.7 | 579.7 | 28.9 | C |
| 39. Olive Drab #52 (wool) | 0.378 | 0.379 | 10.3 | 578.6 | 35.1 | C |
| 40. US Marine Corps Necktie | 0.371 | 0.362 | 19.9 | 581.6 | 28.5 | C |
| 41. US Marine Corps Overseas Cap (summer) | 0.377 | 0.371 | 19.0 | 580.4 | 32.7 | C |
| 42. US Marine Corps Pants (summer) | 0.368 | 0.364 | 21.6 | 580.3 | 28.3 | C |
| 43. US Marine Corps Shirt (summer) | 0.368 | 0.372 | 23.2 | 578.2 | 30.4 | C |
| 44. US Marine Corps Overseas Cap (winter) | 0.329 | 0.345 | 5.4 | 572.0 | 12.8 | C |
| 45. US Marine Corps Blouse (winter) | 0.327 | 0.347 | 5.3 | 569.7 | 12.8 | C |
| 46. US Marine Corps Pants (winter) | 0.329 | 0.344 | 6.0 | 572.3 | 12.5 | C |

CONFIDENTIAL

106

CONFIDENTIAL

NPIC/R-03/72

TABLE 4.3 THE MUNSELL AND ISCC-NBS DESIGNATIONS FOR THE COLORS OF
SELECTED NATURAL AND CULTURAL TARGETS

| Type of Sample | Hue | Value/Chroma | ISCC-NBS Color Designations |
|--------------------------------------------------------------------------|-------|--------------|-------------------------------|
| 20. Wet White Sand, Rodger's Quarry | 0.2Y | 5.2/2.3 | Grayish yellowish brown |
| 21. Wet Yellowish Quartz Sand, Rodger's Quarry | 8.6YR | 5.1/3.7 | Moderate yellowish brown |
| 22. Wet Commercial (Zonalite) "Vermiculite" | 9.2YR | 4.6/1.8 | Grayish yellowish brown |
| 23. Dry White Sand, Rodger's Quarry | 9.8YR | 6.6/2.2 | Light grayish yellowish brown |
| 24. Dry Yellowish Quartz Sand, Rodger's Quarry | 8.9YR | 6.6/3.6 | Light yellowish brown |
| 25. Dry Commercial (Zonalite) "Vermiculite" | 9.0YR | 5.8/1.3 | Light grayish yellowish brown |
| 26. Damp Collington Sandy Loam | 9.6YR | 4.4/1.5 | Grayish yellowish brown |
| 27. Outer Bark, Scrub Pine (Pinus virginiana, Mill.) | 8.0YR | 4.0/1.7 | Grayish yellowish brown |
| 28. Inner Bark, Scrub Pine (Pinus virginiana, Mill.) | 5.6YR | 4.4/2.5 | Grayish brown |
| 29. Outer Bark, White Oak (Quercus alba, L.) | 0.9GY | 5.8/1.1 | Light olive gray |
| 30. Inner Bark, White Oak (Quercus alba, L.) | 9.7YR | 3.2/1.5 | Dark grayish yellowish brown |
| 31. Chinese Red #6335 Chi-namel Paint, Chi-namel Paint and Varnish Co. | 7.2R | 4.6/13.3 | Vivid Reddish orange |
| 32. Colony Yellow #317 House Paint, Lowe Brothers | 3.7Y | 8.5/5.1 | Light yellow |
| 33. Green #173 Tractor Paint, Lowe Brothers | 0.8BG | 3.1/2.9 | Dark bluish green |
| 34. Red #139 Tractor Paint, Lowe Brothers | 5.9R | 3.8/9.8 | Moderate red |
| 35. Royal Blue Permanent Trim Paint, John W. Masury & Son | 2.1PB | 3.7/5.6 | Moderate blue |
| 36. Seal Brown Supreme House Paint, John W. Masury & Son | 3.3YR | 3.3/2.3 | Grayish brown |
| 37. Verdi Green #6830 Super House Paint, Chi-namel Paint and Varnish Co. | 5.5G | 6.1/8.6 | Brilliant green |
| 38. Khaki #1 (cotton) | 1.2Y | 5.5/2.8 | Light olive brown |
| 39. Olive Drab #52 (wool) | 3.0Y | 3.7/2.8 | Moderate olive brown |
| 40. US Marine Corps Necktie | 9.5YR | 5.0/2.7 | Grayish yellowish brown |
| 41. US Marine Corps Overseas Cap (summer) | 0.8Y | 4.9/3.0 | Grayish yellowish brown |
| 42. US Marine Corps Pants (summer) | 0.6Y | 5.2/2.7 | Grayish yellowish brown |
| 43. US Marine Corps Shirt (summer) | 3.0Y | 5.4/2.8 | Light olive brown |
| 44. US Marine Corps Overseas Cap (winter) | 0.1GY | 2.7/0.8 | Olive gray |
| 45. US Marine Corps Blouse (winter) | 1.8GY | 2.7/1.0 | Olive gray |
| 46. US Marine Corps Pants (winter) | 10.0Y | 2.9/0.9 | Olive gray |

CONFIDENTIAL

107

CONFIDENTIAL

NPTC/R-03/72

CONFIDENTIAL

4.3.2 Effects of the Atmosphere and Sun Angle

Two variables that significantly influence the detail and color fidelity of the imagery are the position of the sun with respect to both the camera and the target and the optical state or condition of the atmosphere when the picture is taken. Understanding these variables is important because they are directly related to problems the interpreter may have with interpreting high-quality, small-scale, color imagery. For example, an interpreter working on imagery acquired very late in the afternoon must compensate for the predominately red color of the sunlight reaching the target. The understanding of the color changes or color shifts caused by atmospheric and solar effects is important because such knowledge may help in distinguishing between color changes related to target activity and color changes related to atmospheric and solar effects. In the following discussion, atmospheric and solar effects are treated as independent variables. However, in any given situation, these effects may not be independent. ATMOSPHERIC TURBULENCE and SCATTERING are the two effects that ultimately limit the quality of the imagery acquired by camera systems of excellent overall optical design and performance. This means that beyond a certain limit, a further increase in the size of the optical aperture and the focal length of a lens does not produce an increase in the amount of ground detail that can be resolved. Although a degraded image results from both atmospheric effects, the physical mechanisms that cause the image are quite different.

Atmospheric turbulence is caused by random variations of the air density, i.e., mass per unit volume, caused by random variation in the temperature and atmospheric pressure along the optical path between the target and camera. The INDEX OF REFRACTION, being proportional to density of an optically transparent material like air, is a measure of how much the direction of a ray of light is deviated on passing through the material. Collectively, these random variations in the density of the atmosphere, i.e., index of refraction, cause the atmosphere to appear as though it were composed of a very large number of transparent glass globes of different refractive power. These globe-like cells vary from a minimum size of slightly larger than a golf ball to a maximum size slightly less than a softball. Because the refractive power and size of these turbulence cells varies randomly, the shape of the wavefront is distorted as it passes through the turbulent atmosphere on its way from the target to the camera. Figure 4.4 indicates the image distortion caused by a turbulent atmosphere. This distortion of the wavefront means that the image of the target formed by the optical system will be distorted even if the acquisition system were perfect. Compounding this problem is the variation in time of the size and refractive power of these turbulence cells. Thus, during an exposure a "series" of distorted images are recorded on the film. This distortion of the wavefronts by the atmosphere is more

CONFIDENTIAL

CONFIDENTIAL

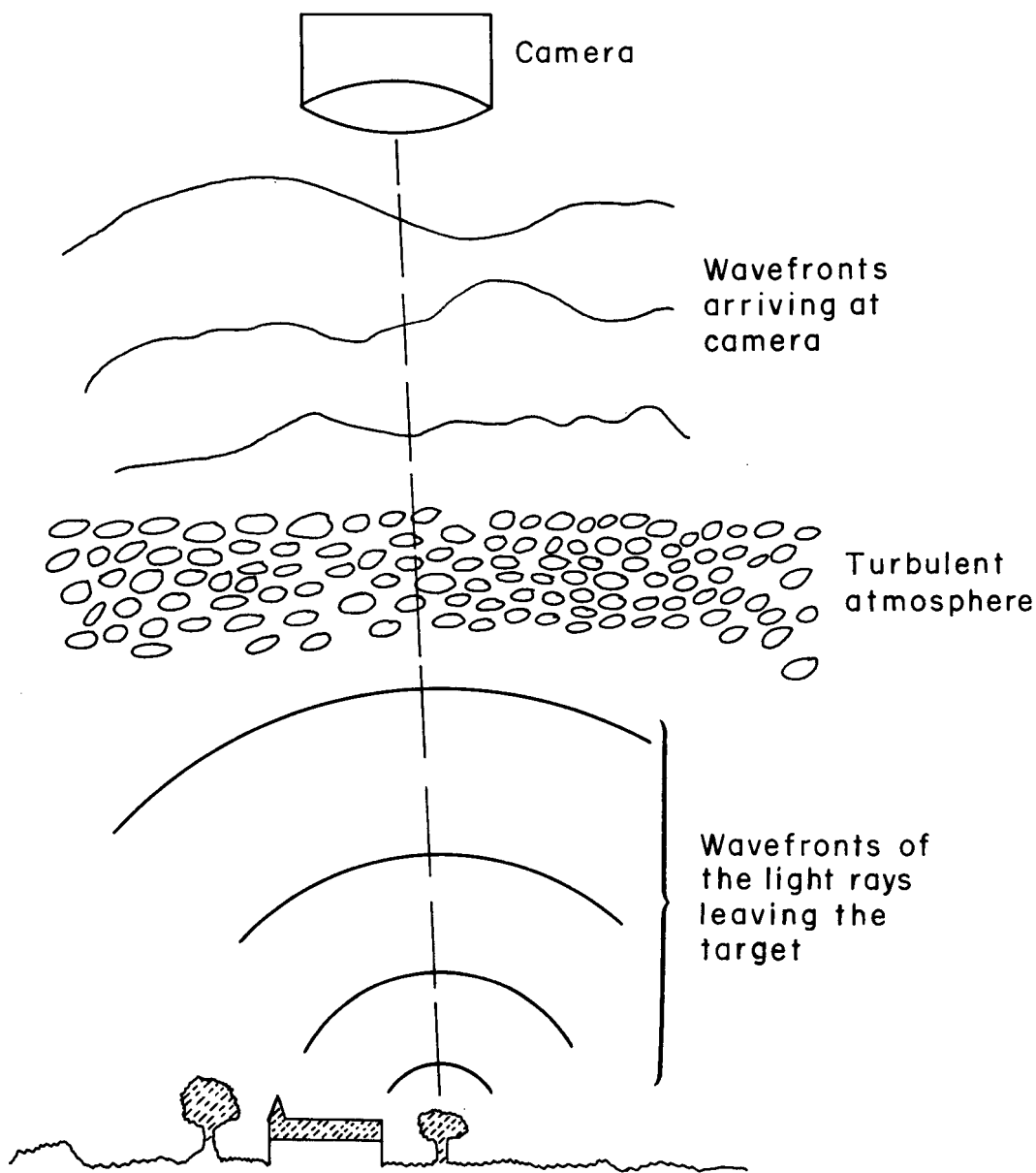

FIGURE 4.4 IMAGE DISTORTION CAUSED BY A TURBULENT ATMOSPHERE

CONFIDENTIAL

disruptive to the high spatial frequencies than to the low frequencies. Consequently, small details in imagery are more easily obscured than large area targets. Since optical turbulence limits the amount of detail that can be recorded by a perfect system, photography above approximately 40,000 feet is limited by the atmosphere to a ground resolution of between 2 and 8 inches. Below 40,000 feet, the maximum ground resolution is determined by a combination of the optical properties of the camera and the atmosphere.

Further degradation of overall detail rendition and color fidelity of color imagery is caused by matter (both gaseous and particulate) in the atmosphere. Light that is traveling from the target to the camera is scattered and absorbed. The absorption or attenuation is caused by the dissipation of some of the light rays' energy. Optical scattering is the absorption and re-emission of light by the gaseous and particulate matter. The way the two phenomenon affect the light and, thus, the contrast and color fidelity of color imagery is shown in Figure 4.5. Optical scattering redistributes part of the light forming the image so that the scattered light acts as a veil which reduces the overall contrast of the scene. Furthermore, scattering reduces the contrast of large and small targets, equally.

The amounts of both optical scattering and absorption are related both to the wavelength of the incident light and to the size and structure of the gaseous and particulate matter in the atmosphere. If the wavelength of the incident light is much larger than the effective cross-sectional diameter of the scattering material, then much more blue light than red light will be scattered. Scattering increases rapidly as wavelength decreases. The situation is much more complicated when the wavelength of the incident light is about the same as the diameter of the scattering material.

In a clear atmosphere and below 10,000 feet, optical scattering and absorption causes little degradation of image detail or color fidelity. The degradation increases from 10,000 to 35,000 feet, but beyond that height, no further increase in image degradation is caused by optical scattering and absorption. In general, atmospheric scattering gives an overall blue cast to a properly exposed frame of color imagery.

Another acquisition variable that contributes to the overall color fidelity of aerial color imagery is the position of the sun with respect to the position of the camera and target. The terms SUN ANGLE or SOLAR ALTITUDE, which are diagrammatically defined in Figure 4.6, define the position of the sun with respect to the camera and the target. The amount of light illuminating the target varies with the sun angle. The relationship between sun angle and target illuminance is shown in Figure 4.7.

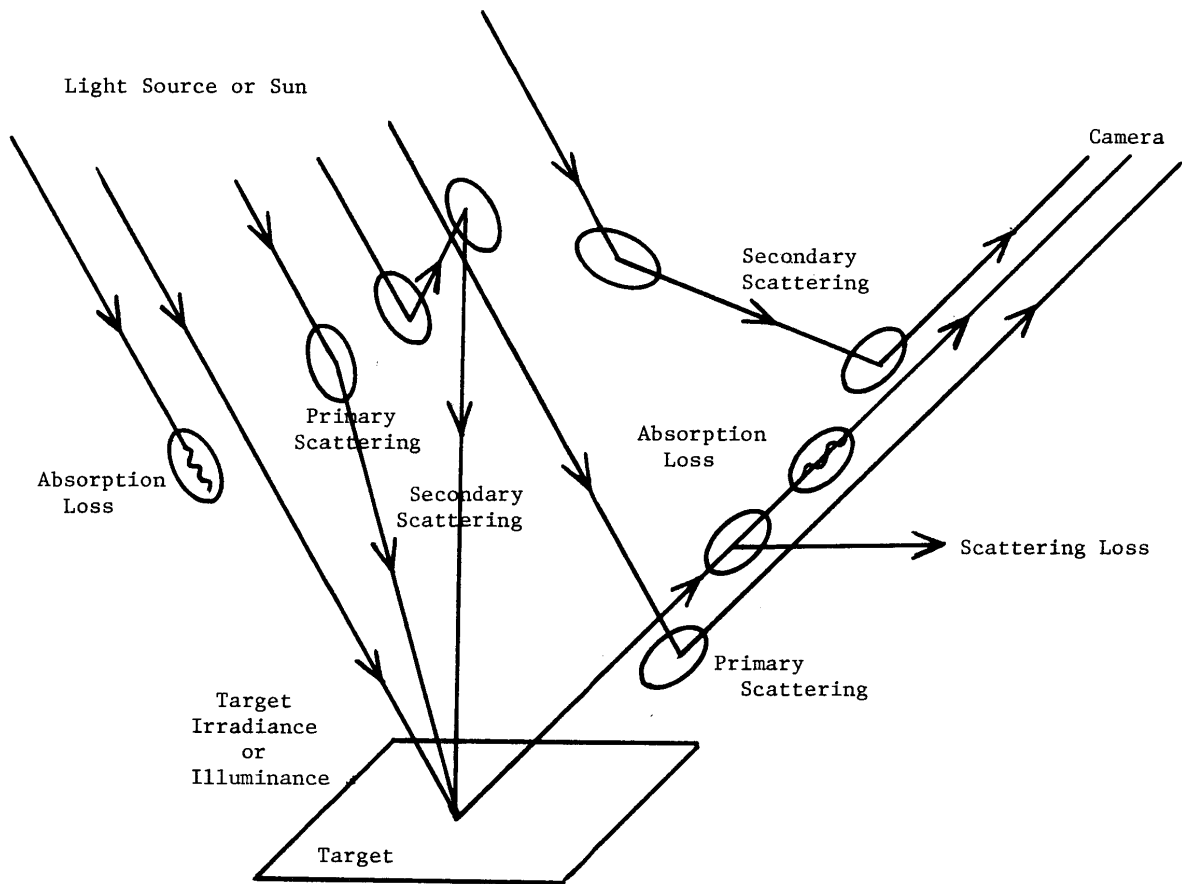

FIGURE 4.5. LIGHT LOSSES CAUSED BY BOTH ABSORPTION AND SCATTERING IN THE ATMOSPHERE

CONFIDENTIAL

111

CONFIDENTIAL

NPIC/R-03/72

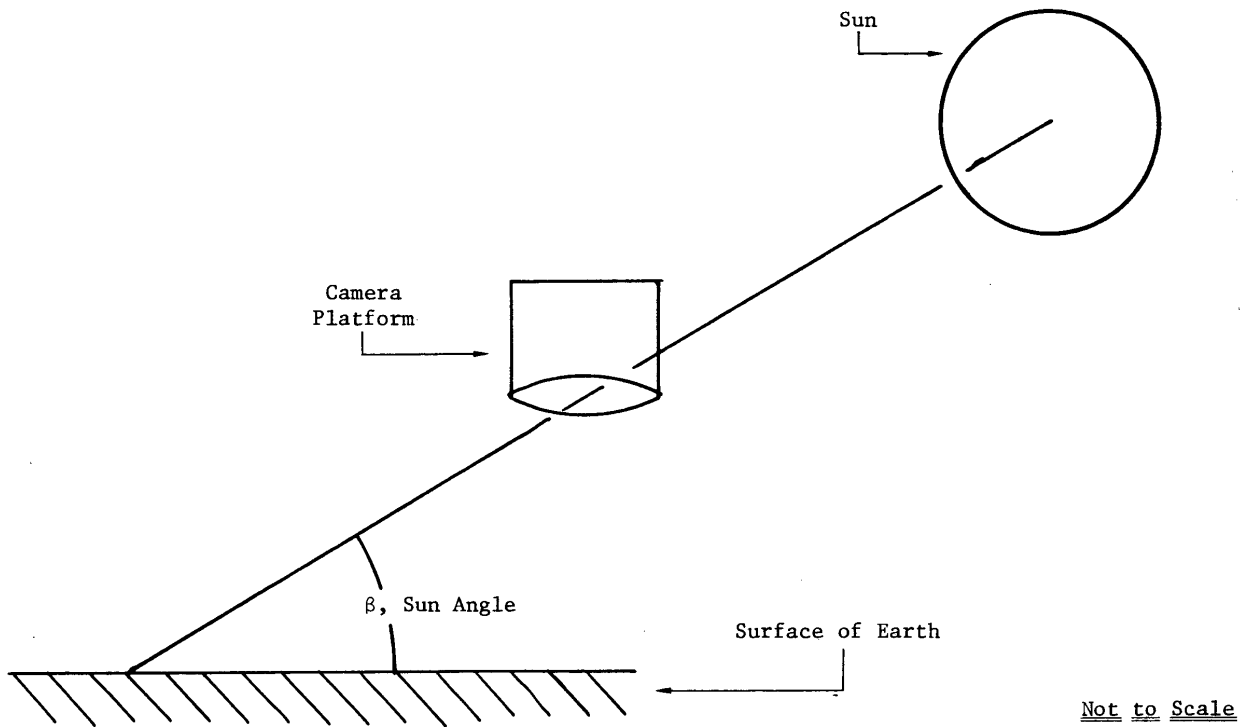

FIGURE 4.6 DIAGRAM OF THE SUN ANGLE OR SOLAR ALTITUDE AND THE RELATIVE POSITIONS OF THE EARTH, CAMERA PLATFORM, AND THE SUN

CONFIDENTIAL

112

CONFIDENTIAL

NPIC/R-03/72

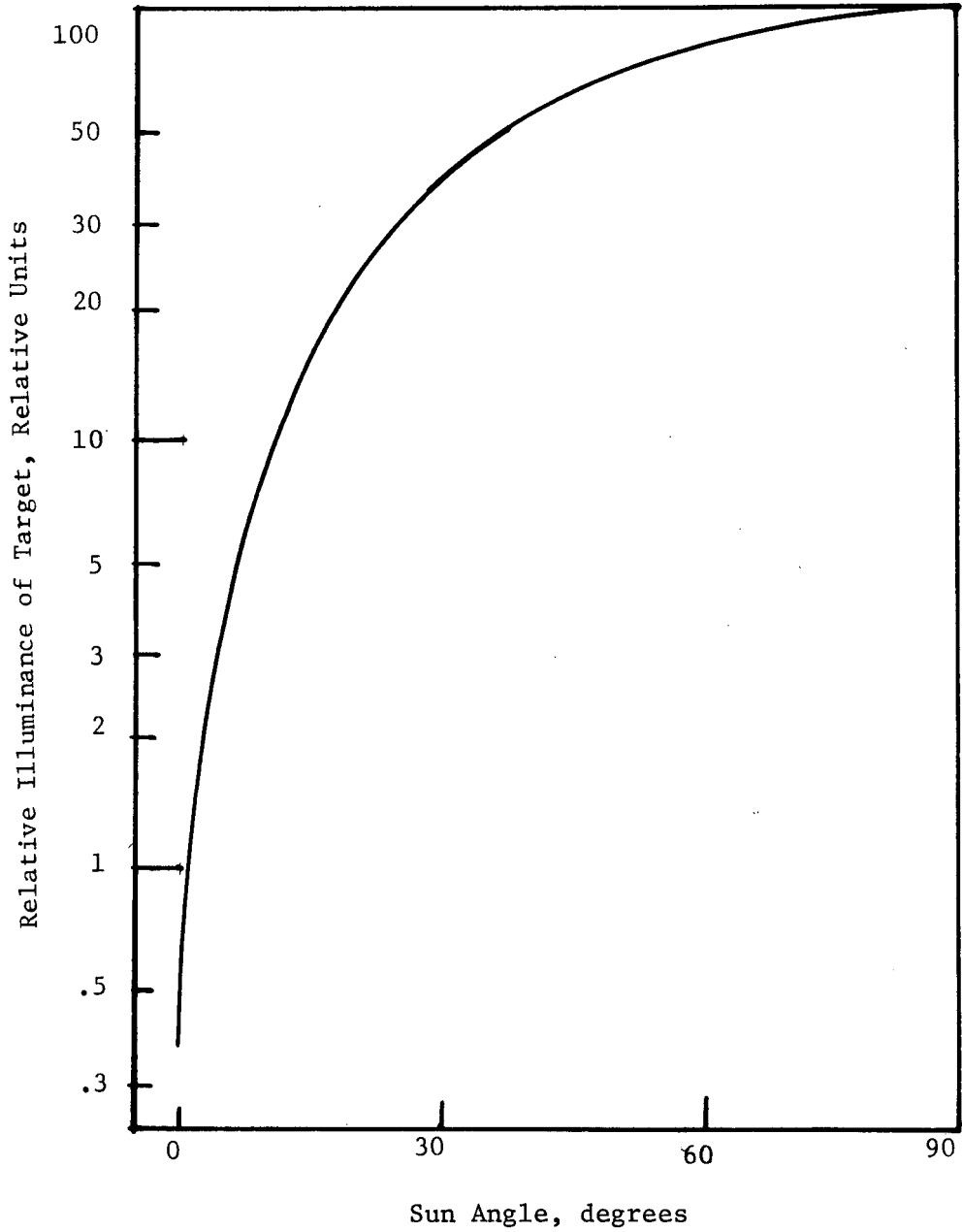

FIGURE 4.7 VARIATION OF TARGET ILLUMINANCE AS A FUNCTION OF SUN ANGLE

Color imagery should not be acquired at sun angles of less than 15 to 20 degrees because there is an insufficient amount of light for a reasonably short exposure time. Also, when the sun angle is low, i.e., less than 15 to 20 degrees, the sunlight illuminating the target has a predominately reddish cast, because most of the blue light has been scattered before it reaches the target. Because the concentration and characteristics of the dyes in the color film are selected to achieve a natural color rendition they are balanced for white sunlight; any color imagery acquired at these low sun angles would have an overall reddish cast.

4.3.3 Effects of Lenses and Lens Aberrations

In general the optical systems used are highly corrected for aberrations and produce a minimum amount of image-quality degradation. The resolution of a DIFFRACTION LIMITED optical system is as high as can be achieved without increasing the optical aperture or using shorter wavelengths. To achieve this near-diffraction-limited performance the "optical defects" or aberrations in these optical systems are minimized by properly balancing the aberrations against each other over a wide range of wavelengths or different colors.

4.3.4 Effects of Platform and Camera Vibration

Platform motion and camera vibration degrade the quality of aerial imagery by decreasing the resolution and the overall sharpness of the imagery. However, no information is available to indicate that platform motion and camera vibration would degrade color imagery any more than it degrades black-and-white imagery of comparable film-resolution capabilities.

4.4 EFFECTS OF FILM AND PROCESSING PARAMETERS ON COLOR AERIAL PHOTOGRAPHY AND COLOR PERCEPTION

4.4.1 Effects of Granularity

The granular structure of the images formed in a dye-based photographic process is quite different from the granular structure of

CONFIDENTIAL

the images formed in a conventional black-and-white silver halide photographic process. The grains in a conventional black-and-white image are very small opaque particles of metallic silver. Colored images are formed by chemically removing, i.e., bleaching, these small metal particles and then using the remaining reaction products to form cyan, magenta, and yellow dyes upon subsequent chemical processing. Thus, each of the small, opaque, silver grains is replaced by one or more translucent blobs of dye of indeterminate size and shape. The OPTICAL DENSITY of these concentrations of dye may increase from approximately zero at their edge to 0.75 at their center. Both the shape of the optical-density profile for these dye concentrations and the optical densities of the images they form are quite sensitive to the hue or wavelength of light used in a densitometer. On the other hand, the optical density of an image formed by particles of metallic silver is nearly independent of color. Not only is the color, shape, size, and texture of the grains that composed the dye-formed colored image different, but they are contained in three separate layers of emulsion rather than in a single layer as in black-and-white silver halide photographic film.

The VISUAL or LUMINOUS DENSITY of these dye masses appears to be the major factor in determining the GRAININESS of dye-formed images; however, this conclusion is based on neither a consensus nor on conclusive experimental evidence. Nevertheless, when uniformly exposed-and-processed yellow, cyan, and magenta images are viewed under identical conditions, the graininess of the yellow image is considerably less than the graininess of the magenta image, and the graininess of the cyan image is somewhere between these two. If the GRANULARITY of these images were measured with a scanning microdensitometer equipped with the proper filters, the differences between the measured values for the granularities of the various images would not be as great as one would be led to believe by the visual appearance. However, the visual or luminous densities of the dye images can quite possibly account for the marked difference in the graininess of these images. The effect of this difference between the granularity or the graininess of dye-formed images on the interpretation of high-resolution color photography is not known.

4.4.2 Effects of Film Variance

The colorimetric properties of color aerial films such as SO-242, SO-255, and SO-360 are known to vary from roll to roll and from coating to coating. Although such variations in the colorimetric properties of these materials can be expected, these variations may not be visually apparent.

CONFIDENTIAL

4.4.3 Effects of Processing Variance

Processing color films is a very complicated and difficult task. Many film factors are controlled during processing, including color balance and dye density. Any variation from prescribed procedures will affect these factors.

CONFIDENTIAL

REF ID: A66722

4.5 REFERENCES

- Anson, A., "Status of Aerial Color Photography in Government Agencies", U. S. Army Engineer Topographic Laboratories, Technical Briefing Report No. 1 (1968), AD 674 189.
- Avery, T. E., Interpretation of Aerial Photographs, 2nd ed., Burger Publishing Company, Minneapolis, Minnesota (1968).
- Bogachkow, N. I., "The Effect of Haze on Aerial Color Photography", Zhurnal Nauchnoy i Prikladnoy Fotografii i Kinematografii, 7(2), pp.112-120 (1962), AD 425 405.
- Born, M. and Wolf, E., Principles of Optics, 3rd ed., Pergamon Press, Oxford (1965).
- Chernov, L. A., Wave Propagation in a Random Medium, Dover Publication, New York (1967).
- Colwell, R. N., "Some Practical Applications of Multiband Spectral Reconnaissance", American Scientist, 49(1), pp 9-36 (1963).
- Dukin, D. R., Bartky, C. D., McManigal, P. G., and Piper, D. G., "Aerial Photographic Energy Model", Air Force Avionics Laboratory, Final Report-68-136 (1968).
- Duntley, S. Q., et al., "Visibility", Applied Optics, 3(5), pp. 549-598 (1964).
- Egan, W. G., "Practical Calibration and Control Techniques for Type 8443 and Ektachrome Films", Grumman Research Department Memorandum, RM-443J (1969), AD 852 804.
- Erb, K. R., Zimmerman, R. R., and Scanlon, T. M., "Atmospheric Effects of Color Aerial Photography", Air Force Avionics Laboratory, Final Report-69-280 (1969), AD 859 961.
- Farrow, J. B., and Gibson, A. F., "Influence of the Atmosphere on Optical Systems", Optica Acta, 17(5), pp. 317-386 (1970).
- Forst, D. J., Hughes, J. B., Pittman, G. A., and Wallace, R. L., "Color Tone Reproduction - Practice Manual", Air Force Avionics Laboratory, Final Report-67-164 (1969), AD 848 115.
- Fried, P. L., "Limiting Resolution Looking Down Through the Atmosphere", Journal of the Optical Society of America, 56(10), pp. 1380-1384 (1966).

CONFIDENTIAL

CONFIDENTIAL

NPIC/R-03/72

Hendeberg, L. O. and Welander, E., "Experimental Transfer Characteristics of Image Motion and Air Conditions in Aerial Photography", *Applied Optics*, 3(4), pp. 379-386 (1963).

Hufnagel, R. E. and Stanley, N. R., "Modulation Transfer Function Associated With Image Transmissions Through Turbulent Media", *Journal of the Optical Society of America*, 54(1), pp. 52-61 (1964).

Hughes, J. G., Jourdjian, A., Forst, D., Bourque, P., and LoVetere, K., "Color Tone Reproduction - Theory Manual", Air Force Avionics Laboratory, Technical Report-67-164 (1968), AD 829 679.

Jensen, N., Optical and Photographic Reconnaissance System, John Wiley and Sons, New York (1968).

Judd, D. B., MacAdam, D. L., Wyszecki, G., "Spectral Distribution of Typical Daylight as a Function of Correlated Color Temperature", *Journal of the Optical Society of America*, 54(8), pp. 1031-1041 (1964).

Keegan, H. J., Schleter, J. C., Haas, G. M., and Hall, W. A., Jr., "Spectrophotometric and Colorimetric Study of Color Transparencies of Some Natural Objects", U. S. National Bureau of Standards, Technical Report 4794 (1957), AD 132 065.

Keegan, H. J., Schleter, J. C., Haas, G. M., and Hall, W. A., Jr., "Spectrometric and Colorimetric Study of Color Transparencies of Some Man-Made Objects", U. S. National Bureau of Standards, Technical Report 4953 (1957), AD 156 751.

Lohse, K. H., "Investigation of Multiband Photographic Techniques - Volume 1", U. S. Army Corps of Engineers, Final Report, DA-44-009-AMC-1218CD (1965), AD 479 300.

MacAdam, D. L., "Small-Field Chromaticity Discrimination", *Journal of the Optical Society of America*, 49(12), pp. 1143-1146 (1959).

Mazurowski, M. J. and Sink, D. R., "Attenuation of Photographic Contrast by the Atmosphere", *Journal of the Optical Society of America*, 55(1), pp. 26-30 (1965).

Meier, H. K., "Color-Correct Aerial Photography", translated from *Bildmessung and Luftbildwesen* (5), pp. 206-214 (1967).

Molineaux, C. E., "Multiband Spectral System for Reconnaissance", *Photogrammetric Engineering*, 3(1), pp. 131-143 (1965).

CONFIDENTIAL

CONFIDENTIAL

- Myzsko, R., "Effect of Vibration on the Photographic Image", Journal of the Optical Society of America, 53(8), pp. 935-940 (1963).
- Paris, D. P., "Influence of Image Motion on the Resolution of a Photographic System", Photographic Science and Engineering, 6(1), pp. 55-59 (1962).
- Rao, C.R.N., "Colorimetric Description of Radiation Emerging From the Top of a Rayleigh Atmosphere", Air Force Cambridge Research Laboratories, Final Report-68-0090 (1968), AD 672 308.
- Reed, H. B., Stiller, J., and Erb, K., "Aerial Color Photographic Research and Flight Tests", Air Force Avionics Laboratory, Final Report-68-187 (1968), AD 843 917.
- Reed, H. B., "Spectral Filtration Research", Air Force Avionics Laboratory, Final Report-67-272 (1967), AD 826 978.
- Rosenau, M. D., "Image Motion Transfer Functions", Photographic Science and Engineering, 9(4), pp. 252-255 (1965).
- Shack, R. V., "The Influence of Image Motion and Shutter Operation on the Photographic Transfer Functions", Applied Optics, 3(10), pp. 1171-1181 (1964).
- Smith, J. T., Manual of Color Aerial Photography, 1st ed., American Society of Photogrammetry, Falls Church, Virginia (1968).
- Specht, M. R., Fritz, M. L., and Soren, A. L., "The Change of Aerial Camera Exposure With Solar Altitude", Photographic Science and Engineering, 10(3), pp. 150-155 (1966).
- Stultz, K. F. and Kock, D. A., "Role of Chromaticity Difference in Color Graininess Judgments", Journal of the Optical Society of America, 46(10), pp. 832-837 (1956).
- Tatarski, V. I., Wave Propagation in a Turbulent Medium, Dover Publication, New York (1967).
- Winterberg, R. P. and Wulfeck, J. W., "Additive Color Photography and Projection for Military Photo Interpretation", Photogrammetric Engineering, 27(2), pp. 450-459 (1961).
- Yates, H. W., "A General Discussion of Remote Sensing of the Atmosphere", Applied Optics, 9(9), pp. 1971-1975 (1970).

CONFIDENTIAL

CONFIDENTIAL

REF ID: A660372

Yereance, R. A., Easterday, J. L., and Stephan, J. G., "Aerial Photography-Photosensors", Unpublished Battelle Report, October, 1967.

Yost, E. F. and Wenderoth, S., "Multispectral Color Aerial Photography", Photogrammetric Engineering, 33(9), pp. 1020-1033 (1967).

Yost, E. F. and Wenderoth, S., "Additive Color Aerial Photography", in Manual of Color Aerial Photography, American Society of Photogrammetry, Falls Church, Virginia, pp. 541-471 (1968).

Zwick, D., "Colour Granularity and Graininess", Journal of Photographic Science, 11(5), pp. 269-275 (1963).

CONFIDENTIAL

CONFIDENTIAL

5.0 APPLIED ASPECTS OF COLOR AND COLOR PERCEPTION IN IMAGE INTERPRETATION

The literature was surveyed to determine the research findings and experiences of investigators with the interpretation and use of color aerial photography; included were books, journals, trade journals, and Government reports. These sources covered many fields of endeavor, including military image interpretation, agriculture, archeology, biology, forestry, geology, geography, hydrology, highway research, mapping, marine studies, and oceanology. The information sought from these sources included the advantages and disadvantages of color films; the detection, identification, and interpretation of targets on color films; the optimum film/filter for particular classes of targets; the use of PI equipment (stereoscope, magnifier, rear projection, mensuration equipment, etc.) with color films; and the optimal illumination requirements.

The results of the literature search are discussed below.* Most findings and experiences reported are opinions and judgments rather than conclusions drawn from experimental data. In addition, the majority of the studies used low-altitude, large-scale imagery. Further, the vast majority of findings were drawn from studies in areas other than military interpretation, since the use of color films has been limited in tactical and strategic interpretation.

5.1 INTERPRETATION OF COLOR FILMS

The interpretation of color films includes the detection, identification, and analysis of targets and their backgrounds. Numerous studies have investigated the use of color films for the interpretation of many different types of targets and backgrounds. A few of these studies were experimental and, thus, the findings were conclusions drawn from experimental data. The majority of studies were operational, and the findings were based on expert judgment of what was shown and seen on the imagery.

Since these two types of studies resulted in somewhat different conclusions, their findings are discussed in two separate sections (5.1.2 and 5.1.4). Many investigators have discussed the theoretical advantages

* The classified information in this topic area is included in the report entitled "A Review of Color Science and Color Aerial Reconnaissance: An Addendum".

CONFIDENTIAL

CONFIDENTIAL

REF ID: A66975

of using color films and these discussions are presented first. Another section discusses the advantages and disadvantages of specific color films and color techniques as found by users (5.1.3).

5.1.1 Theoretical Advantages of Color Films

Theoretically color films should be superior to panchromatic for intelligence extraction given comparable resolutions. It is important to understand the reasons for this theoretical superiority, because these reasons may help explain the operational success of color films.

- (1) The human visual system can differentiate more color differences than gray-scale differences, thus on color films (natural or false) greater detail should be detected (See 2.2.2 Spectral Range).
- (2) If a target's color or false-color is its only identification clue, then the target can be identified only on color films.
- (3) If a target and its background image are the same shade (or near shade) of gray on black-and-white films, but image in different colors on color films, then the target can best be detected and identified on color films.
- (4) Differences between colors are more discernible or conspicuous than gray-scale (achromatic) differences; consequently, a target whose color differs from its background should be detected and identified faster on color films.
- (5) If a target's spectral distribution is different from its background, then a film/filter combination (color, false color, or panchromatic films with appropriate filters) can be found which will improve the target's contrast with its background. This consideration is the basis for spectrazonal or multispectral photography (see 4.2.3 Spectrazonal or Multispectral Film and Techniques) and the use of enhancement filters (see 5.4 Enhancing the Interpretation of Color Films).

CONFIDENTIAL

CONFIDENTIAL

5.1.2 Experimental Comparisons of Color Films With Black and White Films

Several studies have experimentally investigated the interpretation of color films (natural and false) and black and white films. These investigations compared natural color and/or color infrared (IR) with black and white imagery of the same scene (at the same scale) using interpreter performance measures, e.g., detection completeness and accuracy, identification completeness and accuracy, and time measures. In general, the targets (tactical, strategic, and COIN) chosen for interpretation were those found on the available imagery, and those targets imaged on color films were also imaged on black and white films.

Experimental evidence has not conclusively shown that more targets can be detected or identified on color or false color films, than on panchromatic film (Foley and Smith, 1967; MacLeod et al., 1969; Anson, 1966a, 1966b; 1969; Self and Myers, 1970; Levine, 1969). In some experiments, the interpreters detected and identified significantly (statistically) more targets on color and color infrared than on black and white film, but in other experiments, interpreter performance was not significantly different from film to film. It is very difficult to explain precisely why this inconsistency has occurred. It is most likely due to differences between experiments, i.e., different imagery, instructions, interpreters, tasks, time allotments, targets, etc. However, due to the complexity and interactions of the differences, it is doubtful that a satisfactory explanation is possible.

There is evidence that target detection and identification time is significantly faster on natural color and color infrared films than on panchromatic (Foley and Smith, 1967; Anson, 1970; Welch R., 1969; NRTSC, 1970; Hostrop and Kawaguchi, 1971).

The use of all three individual spectrazonal (see 4.2.3 Spectrazonal or Multispectral Films and Techniques) transparencies (each filtered by a red, blue, or green filter on panchromatic) improved detection and identification performance over that for full-color or black and white displays generated from the same three filtered transparencies (Winterberg and Wulfeck, 1961).

5.1.3 Operational Findings on Color Film and Color-Imaging Techniques

Those investigators who have worked with color films and color imaging techniques (see 4.2 Photographic Properties of Selected Aerial

CONFIDENTIAL

CONFIDENTIAL

MFC/R-03/72

Films, for technical descriptions) have reported advantages and disadvantages with these, irrespective of target type. The advantages and disadvantages are listed below by film and/or technique. It should be noted that these findings are judgments and opinions of users and not conclusions drawn from experimental data.

5.1.3.1 Natural Color Films (see 4.2.1 Color Films)

5.1.3.1.1 Advantages

- (1) Natural color films often permit better identification of the surface (target or background) details (Letourneaux, 1969; Parry et al., 1969a; Welch, 1967) if the details are of different colors.
- (2) Although natural color films have poorer resolution than panchromatic films, investigators have reported subjective impressions of better resolution on color films due to the greater amounts of target or surface detail. However, it is not known if this subjective impression has any relationship to performance.
- (3) Targets with distinctive colors greatly different from their background may be identifiable even though the targets are beneath the actual resolution of the color film (Yereance, et al., 1967). Here, target shape is not resolved, but a distinctively colored area reveals the target.
- (4) Target and ground details in shadows are best detected and identified on natural color films (McDaniel and Arntz, 1959; Reed, 1967; Welch, 1967). Shadow detail reflects skylight which is predominantly blue. Thus, a film sensitive to the blue region is necessary for shadow detail. Although panchromatic films are sensitive in the blue regions, minus-blue haze filters are often used, thus reducing shadow detail. A similar result will occur if minus-blue filters are used with color films. In addition, if a color film has inherently poor blue sensitivity, the shadow detail may not be as detectable as on other color films.

CONFIDENTIAL

5.1.3.1.2 Disadvantages

- (1) The primary limitation of color films is its lower resolution compared to black and white. In intelligence extraction from film, resolution is the most important film parameter for the identification and description of targets of concern.
- (2) The second primary limitation of natural color film is its degradation by atmospheric attenuation (see 4.3.2 Effects of Atmosphere and Sun Angle). The result of this degradation is an overall bluish cast on the imagery and a reduced color fidelity. High-altitude and satellite imagery over humid regions are particularly vulnerable to atmospheric attenuation, but the problem is reduced when acquisition is over arid regions (Blackband, 1968; Anson, 1968b). It has been reported that below 12,000 feet, haze is not a significant problem (Mott, 1966). However, degradation is dependent on the amount of particles in the air (this can vary at any altitude).

Although haze filters (Wratten Filters, Nos. HF-1 to HF-5 are generally recommended, NRTSC, 1970; or the filter may be an integral layer in the emulsion) are available to reduce haze degradation, the blue sensitivity of the film is reduced (reducing shadow detail and the imaging of blue colors), and a yellowish cast over the image that can occur may hinder interpreter performance.

- (3) The small exposure latitude of color films also has implications for interpretation. Many investigators have reported degraded imagery due to improper exposure. Generally an overexposure of one stop can cause a greenish cast on the imagery.
- (4) The colors on successive overlapping (stereo) frames change due to a change in acquisition angle or VIGNETTING. For example, a blue-green truck on one frame may be blue on the next frame.
- (5) Highly reflective surfaces tend to bloom on color films and reduce surface detail.

- (6) As acquisition altitude increases, surface colors tend to blend such that a grouping of targets (e.g., trees) may have a color that is different from individual targets (Carnegie, 1968a).
- (7) The processing of color films requires more precision than black and white films. Any deviation from prescribed procedures can significantly affect the color fidelity, color balance, and color contrasts on the image, and thereby affecting interpretation.
- (8) The reproduction of color transparencies for reports, transparent copies, etc., is difficult and costly. The most successful reproduction technique (in terms of color fidelity, balance and contrast) is through the use of COLOR SEPARATION NEGATIVES where the film is copied onto three transparent negatives, through three different filters; red, blue, and green. These negatives are then copied, in register, onto color photographic paper or film. This technique is time consuming and costly; but alternative techniques result in copies of reduced color fidelity and balance.

5.1.3.2 Color Infrared Film (Ektachrome Infrared 8443, See 4.2.2 False-Color Films)

5.1.3.2.1 Advantages

- (1) Color IR penetrates haze and smoke better than any other acquisition materials, because it is used with a minus-blue filter (Ciesla et al., 1967; Chaves and Schuster, 1968; Specht, 1970; Anderson, 1969; Pease and Bowden). Many have reported that it should be preferred to natural color films for high-altitude photography (TARC, 1965; Reed, 1967).
- (2) Color IR images healthy and near-healthy vegetation as a deep-red or magenta color (Marechal, 1966; Fritz, 1967). Thus, vegetation can be differentiated from most all other targets and backgrounds.

CONFIDENTIAL

5.1.3.2.2 Disadvantages

- (1) The false colors require interpreters to learn a new set of color/object associations (Leibowitz, 1967).
- (2) The range of color produced on Color IR is limited compared to that for natural color, thus, less surface detail is imaged (Chaves and Schuster, 1968).
- (3) Cloud shadows are very dark because the clouds filter out infrared radiation (Chaves and Schuster, 1968).
- (4) Details within shadows are illuminated mostly by blue scattered light from the sky. Hence, the shadow details are less than on natural color, because of the film's reduced blue sensitivity and the use of a Wratten 12 (minus-blue) filter (Chaves and Schuster, 1968; Reed, 1967; Fritz, 1967; NRTSC, 1970).
- (5) Hardcopy prints of color IR reduce the number of red and magenta tones and; thus, information may be lost (Marechal, 1966).
- (6) Color balancing during processing is more difficult than with natural color, because there are no true colors with which to judge (Reed, 1967; Fritz, 1967).
- (7) Exposure latitude is small (normally within 1/2 stop of the correct setting, Fritz, 1967; Welch, 1967).

5.1.3.3 Additive Color Separation (See 4.2.4 Additive Color Separations)

5.1.3.3.1 Advantages

- (1) Because the separate transparencies are produced using panchromatic film, the exposure latitude,

CONFIDENTIAL

resolution, and film speed are better than on color film. Thus, the advantages of color can be obtained along with the advantages of panchromatic film (Winterberg and Wulfeck, 1961; Reed, 1967; Welch, 1967).

- (2) The intensity and filtering of the light transmitted through each transparency can be controlled, thus providing flexibility and control over color contrasts and colors (Winterberg and Wulfeck, 1961; Yost and Wenderoth, 1967). This control enables making of colors that closely match true ground colors (Yost and Wenderoth, 1971).
- (3) Two-color (bi-color) renditions can be displayed; this may enhance the contrasts of some targets with their backgrounds (Winterberg and Wulfeck, 1969; Yost and Wenderoth, 1967).

5.1.3.3.2 Disadvantages

- (1) The primary disadvantages of separate transparencies is that during acquisition the scene must be imaged the same on each transparency (Winterberg and Wulfeck, 1961; Reed, 1967). If differences occur between the transparencies, they cannot be accurately registered, and the overall composite may become very poor to useless. Also, during display, nonregistration may result in edges showing a "rainbow effect", i.e., there will be red, blue, and green fringes along each edge. This edge degradation may also interfere with interpretation.
- (2) Special equipment is required to display the transparencies for full or partial color.
- (3) Processing for each film must be adjusted to compensate for differences in contrast (Reed, 1967).

CONFIDENTIAL

5.1.3.4 Spectrazonal or Multispectral Techniques
(See 4.2.3 Spectrazonal or Multispectral
Film and Techniques)

5.1.3.4.1 Advantages

- (1) If exact SPECTROPHOTOMETRIC data are available for a specific search problem, then a single film/filter condition should produce optimal results (Winterberg and Wulfeck, 1961; Molineaux, 1965).
- (2) The film generally used is panchromatic which has excellent exposure latitude, film speed, and resolution.

5.1.3.4.2 Disadvantages

- (1) The amount of spectral information for most tactical, COIN, strategic, cultural and natural targets and backgrounds is very limited (Winterberg and Wulfeck, 1961; Yost and Wenderoth, 1971).
- (2) For full-scene interpretation, a large number of film/filter combinations would be required, since each target/background may require a different film/filter combination for optimal results (Winterberg and Wulfeck, 1961).
- (3) The spectral distribution of a target may change when viewed from a different angle, illumination condition, or altitude (Winterberg and Wulfeck, 1961). Thus, unless acquisition conditions are known, choosing optimal film/filter combinations for a target is difficult.

CONFIDENTIAL

5.1.3.5 Black and White Infrared (Kodak Infrared Aerographic Film, See 4.2.4 False-Color Films)

5.1.3.5.1 Advantages

No interpretation advantages over color infrared films (Marechal, 1966) are apparent. However, processing, reproducing, and hard-copy printing are easier and less costly.

5.1.3.5.2 Disadvantages

Resolution is poor, particularly when lenses used are not designed to be used with black and white infrared (Marechal, 1966).

5.1.4 Operational Findings on the Interpretation of Targets and Backgrounds on Color Films

Investigators who have used color films for specific tasks or targets, generally judge them to be superior to panchromatic films. This superiority appears to stem from (1) color contrasts, (2) greater surface details (due to color differences) apparent on color film, and (3) the use of color as an identification clue. Primarily, however, it appears that color contrast is the prime factor in the judgments of the investigators. Consequently, in the following discussion (unless otherwise noted) statements such as "target A is best detected on film B" mean that the contrast of target A with its background is highest on film B.

This discussion is divided into three target classes (tactical, strategic, and cultural) and four backgrounds (vegetation, soils, water, and geologic features). Available information on the use of color films for the target types is very limited at this time, since the organizations interested in these types of targets have not used color extensively. On the other hand, there is a significant amount of information on the backgrounds, since color films are used more extensively in agriculture, forestry, geology, oceanology, etc.

Note that the backgrounds discussed are important in reconnaissance. It is important to understand how backgrounds appear on color films so that targets can be distinguished from them. Also, it is important to be able to identify the type of background present. For example, swamps appear

CONFIDENTIAL

25X1

Approved For Release 2003/05/14 : CIA-RDP78B04560A007300010030-5

Next 3 Page(s) In Document Exempt

Approved For Release 2003/05/14 : CIA-RDP78B04560A007300010030-5

TABLE 5.1. ACCURACY OF CROP IDENTIFICATION
ON TRUE COLOR FILM (National
Research Council, 1970)

| Crop Type | Correct Classification in % (Sample Sizes in Parentheses) by Using | | | |
|------------------|-----------------------------------------------------------------------|------------------------------|-------------------|-------------------------------------------|
| | 1. Brightness Alone | 2. Stereo Height Alone | 3. Color Alone | 4. Color and Stereo Height Combined |
| Winter Wheat | 5 (78) | 6 (54) | 17 (78) | 49 (35) |
| Spring Wheat | 0 (16) | 12 (8) | 56 (16) | 86 (7) |
| Spring Barley | 6 (16) | 45 (11) | 56 (16) | 71 (7) |
| Oats | 0 (12) | 14 (7) | 25 (12) | 17 (6) |
| Potatoes | 7 (56) | 21 (48) | 30 (56) | 67 (27) |
| Beets | 10 (20) | 53 (15) | 35 (20) | 71 (7) |
| Corn | 20 (5) | 40 (5) | 40 (5) | 100 (4) |
| Rape | 20 (3) | 67 (3) | 40 (5) | 100 (2) |
| Hop | 77 (13) | 100 (9) | 77 (13) | 100 (8) |
| Tobacco | 11 (9) | 20 (5) | 56 (9) | 100 (4) |
| Hay | 11 (54) | 69 (67) | 9 (54) | 29 (34) |
| Overall Accuracy | 11 (284) | 38 (232) | 29 (284) | 57 (141) |

CONFIDENTIAL

135

CONFIDENTIAL

NFIC/R-03/72

25X1

Approved For Release 2003/05/14 : CIA-RDP78B04560A007300010030-5

Next 2 Page(s) In Document Exempt

Approved For Release 2003/05/14 : CIA-RDP78B04560A007300010030-5

CONFIDENTIAL

Harris, et al., 1968; Schallock, 1968; Woodrow, 1967). Conventional color films have been shown to be vertically stable, and for conventional tolerances, as accurate as panchromatic for evaluation measurement (Umback, 1968; Reeves, 1969; Harris, et al., 1968). It should be remembered, however, that color films have more than one layer and determining an edge may be more difficult. Thus, when using color films less mensuration accuracy and greater variability between photogrammetrists would be expected. The inaccuracies and variability may not be important unless very close tolerances are required and image scale is extremely small.

5.3 INTERPRETATION TECHNIQUES AND COLOR FILMS

5.3.1 Stereoscopic Viewing

The advantages of using a stereoscope with color films is the same as for use with panchromatic. As summarized below, stereoscopic viewing may present problems, but their significance is not presently known. (See also 2.4 DEPTH PERCEPTION AND COLOR.)

The color of a target on one frame of a stereo pair may be different from its color on the other frame; thus, when the target is fused with the aid of a stereoscope, its fused color may be different from the target's color on either frame (or fusion may not occur at all). The color differences of a target between frames generally occurs when, on at least one frame, the target falls on the VIGNETTING affected region. Within this affected region, the color of targets has a lower brightness value (2-3 Munsell value steps have been reported, Parry, et al., 1969a). A hue shift toward the blue may also be noted.

Several investigators (Silvestro and Hammill, 1967; MacLeod, et al., 1969) have placed a color image under the one side of a stereoscope, and a black and white image of the same scene under the other side, in hopes that the visual system would fuse the colors of one side and the better resolution of the other. All combinations of color, Color IR, and black and white film have been tried, however, interpreter performance was never improved. In fact, some interpreters were unable to obtain binocular fusion.

5.3.2 Magnification

Due to the graininess (or "globiness") of conventional color films, the usable power of magnification is less than with panchromatic.

CONFIDENTIAL

CONFIDENTIAL

Generally, 10 to 15X has been reported to be maximum for good viewing of conventional color films. Higher magnifications can be used with films that have a greater resolving power than these conventional color films.

As the magnification is increased, however, the colors on color films tend to lose saturation and become diffused (Mott, 1966; Welch, 1967). Pastel shades (unsaturated colors) are particularly affected. This problem would affect color matching, particularly if the target was being magnified, and the reference color, e.g., a Munsell chip, was not. Also, it may affect color naming, in that the color under high magnification may be named a "lighter" color than is shown on the film.

5.3.3 Scanning Strategies

An interpreter's scanning strategy should not be different for color films, unless specific colors are being searched for or specific colors are being ignored. For example, an interpreter may be searching for color codes on military equipments. In time, the interpreter may automatically search for particular colors (which may have intelligence value) just as he searches for shapes, patterns, and textures. It has been shown that when color, shape, and size are given as identification clues, color is used predominantly during search (Williams, 1967).

5.3.4 Multisensor Viewing

Certain target-background contrasts are enhanced by natural color films, still others are enhanced by Color IR, and target detail may best be registered on panchromatic. The interpretation of all three films (plus other sensors) for a given scene would improve the probability that all targets on the image would be detected, identified, and analyzed.

5.3.5 Change Detection

The color change of a target and/or its background can be important to intelligence and interpretation (NRTSC, 1970). For optimal detection of color changes, natural color films would be needed, although Color IR may be required at times, e.g., for a change in vegetation vigor as a part of bomb, chemical, or biological damage assessment.

CONFIDENTIAL

CONFIDENTIAL

The interpreter, however, must be aware that a color change on the film may not be due to the target or background. Rather an apparent color change can also be due to various factors, i.e., sun angle, altitude, time-of-day, camera lenses, processing parameters, position of the target on the frame, etc. (see 4.3 EFFECTS OF TARGET AND ACQUISITION PARAMETERS ON COLOR AERIAL PHOTOGRAPHY AND COLOR PERCEPTION, and 4.4 EFFECTS OF FILM AND PROCESSING PARAMETERS ON COLOR AERIAL PHOTOGRAPHY AND COLOR PERCEPTION.

5.3.6 Reporting Strategies

The most common strategy for reporting the color names of targets has been the use of everyday language. The colors reported have been based on the judgment of the interpreter, e.g., green vegetation, blue water, etc.. Although this method provides a general impression of the color (which may be sufficient for most reporting), color terms usage and perception vary with people.

Munsell chips (see 3.3.1 Munsell Color System) have been used for reporting the colors of trees (Parry, et al., 1969a) and soils (Parry, et al., 1969b) on color films. For these targets the Munsell color chip which was the closest match to the target's predominant color (see Table 5.2) was reported e.g., 5YR 3/1. This method is preferred when precise color reporting is required or when a color sample is needed for communication.

When using Munsell chips four very relevant problems were noted by Parry, et al. The first problem arose when matching the paint chip with the transparency. The texture difference between the two, initially caused perceptual confusion, but the authors apparently were able to adapt to this situation. Second, the source of illumination for the transparency was different from that of the chips. However, according to the authors who used this technique, the sources of illumination could be varied in intensity and position to achieve reliable color matching. The third problem was how to report the color of a multicolored target. The authors using this technique solved the problem by reporting the predominant range of colors and included other frequently occurring colors (see Table 5.2). The fourth problem resulted when a particular target fell on successive frames (stereo-pairs). On at least one frame the target would fall near the edge and be darkened by the VIGNETTING effect. The frame in which the target fell closest to the center was used for color matching.

A similar method to the Munsell has also been used at the State of Ohio Aerial Engineering Office. This method Crafttint colored matte papers (numbering 250) that are used like Munsell chips. These papers are

CONFIDENTIAL

TABLE 5.2 SOILS OF THE LAC BEVIN BASIN AND THEIR MUNSELL VALUES (Parry, et al., 1969a)

| Soil Group | Soil Series | Soil Type | | Nos. of exposures | Total acreage | Organic Carbon Content, percent | Iron Content, percent | Soil Color in Field | | Soil colors and neutral values from air photos | | | |
|--------------------|--------------|---------------------|------|-------------------|---------------|---------------------------------|-----------------------|---------------------|--------------------|------------------------------------------------|--------------------------------------------------|------------------|---------------------|
| | | USDA | USCS | | | | | Air dry | At field capacity | Color Photos | | Pan. photos | |
| | | | | | | | | | | Predominant color or range | Other colors present | Predominant tone | Total range present |
| Gray gleisol | Brandon | Clay | ML | 3 | 24 | 3.7 | 5.0 | 5Y7/2 10YR4/1 | 2.5Y4/2 10YR3/1 | 5B7/0-1:4/0-1 5BG7/0-1:6/0-1 | 7.5YR6/4:5/4 10YR8/0-1:6/0-1 | N6 | N7-5.5 |
| Brown podzolic | Brebeuf | Silt loam | ML | 1 | 37 | 3.0 | 4.1 | 10YR3/1 | 5YR2/1 | 10YR8/1-4:5/1-4 | 5YR4/3-6:5/3-6 5YR6/1:7/1 | N7.5 | N7.5-3.5 |
| Podzol | St. Gabriel | Gravelly sandy loam | SM | 8 | 66 | 3.2 | 7.0 | 10YR5/4 | 10YR3/2 | 10YR8/0-4:3/0-4 | | N5.5 | N7-3.5 |
| Podzol | Ivry | Fine loamy sand | SM | 1 | 8 | 3.9 | 3.5 | 10YR6/3 | 10YR5/3 | 10YR6/1-2:4/1-2 | 10YR8/0-4:7/0-4 10YR3/1 | N6 | N8-5 |
| Brown podzolic | Lesage | Sandy loam | SM | 3 | 11 | 2.7 | 3.5 | 10YR7/3 5Y7/3 | 10YR4/3 5Y7/3 | 10YR8/0-4:4/0-4 5B8/1:7/2 5BG6/1:7/1 | 5B8/1:4/1 7.5YR6/2-4:5/2-4 10YR8/1-4:4/1-4 | N5.5 | N8-3.5 |
| Podzol | Mont Rolland | Gravelly sandy loam | SM | 1 | 10 | 4.5 | 7.4 | 10YR6/3 | 5YR4/4 | 10YR8/0-3:4/0-3 | 7.5YR7/6:6/6 | — * | — * |
| — | organic | Muck | Pt | 2 | 8 | 47.7 | — | — | — | 10B3/2.5 | | N3 | N4-3 |
| Podzol | Piedmont | Sandy loam | SM | 3 | 26 | 3.6 | 5.0 | 10YR5/2 2.5Y6/2 | 10YR3/2 10YR4/2 | 5YR6/4-6:5/4-6 5B8/1:5/1 10B4/0-2:3/0-2 | 5B8/1:4/1 5B9/0-2:7/0-2 | N6 N6 N4 | N7-4 |
| dark gray glei-sol | Brandon | Clay | ML | | | 3.7 | 5.0 | 5Y6/1 | 5Y5/1 | | | | |
| Podzol | Guindon | Light sandy loam | SM | | | 6.7 | 4.8 | 10YR5/4 | 10YR3/3 | 7.5YR6/1-3:4/1-3 | 7.5YR8/1 | N6 | N6-5 |
| Podzol | Ste. Agathe | Stony sandy loam | SM | 4 | 11 | 3.5 | 5.0 | 10YR5/4 10YR4/3 | 10YR3/2 10YR3/3 | " | " | " | " |
| | | Totals | | 26 | 201 | | | | | | | | |

CONFIDENTIAL

CONFIDENTIAL

CONFIDENTIAL

numbered such that reference can be made to the numbers instead of a color name. However, the papers are limited in colors and shades, and they do not relate to a logical system of color naming.

5.4 ENHANCING THE INTERPRETATION OF COLOR FILMS

Image enhancement techniques can be used to increase the contrast of a target with its background, improve the edge definition of the targets, or separate certain targets from all other targets on an image. Such enhancement can improve interpretation. The use of enhancement techniques for color films have not been used extensively, because the primary effort has been to obtain good-quality, color images, rather than enhancement techniques. Thus very few techniques are presented.

5.4.1 Enhancement During Acquisition

5.4.1.1 Haze Filters

These filters (yellow in color, but usually called minus-blue filters) are used in conventional cameras (not required with color films whose first emulsion layer acts as a haze filter) to correct for the effect of atmospheric haze on the color imagery (see 4.3.2 Effects of Atmosphere and Sun Angle). Haze (smoke, moisture, dust, etc.) tends to scatter the blue wavelengths more than those for reds and greens. These scattered wavelengths, mixing with other wavelengths at the image plane, result in an image of bluish cast. To avoid this situation a minus-blue filter is used to selectively reduce the intensity of blue wavelengths, color balance is thereby improved. The primary problem is that the filter also reduces information in the blue layer of the film. How this reduced information affects intelligence extraction is not entirely known, although shadow detail is reduced.

5.4.1.2 Antivignetting Filters

These filters are used (in conventional color systems) to reduce the variation in illumination at the focal plane (on the film). On color film, the edges and corners of the frame appears less bright and often bluish. To correct for this variance in illumination, filters that are darker at the center than at the edges provide a more uniform field of illumination at the focal plane. The primary problem with using these filters is the reduced

CONFIDENTIAL

CONFIDENTIAL

amount of illumination at the focal plane. Color film requires high levels of illumination for proper color balance and fidelity. Any reduction or filtering of light may degrade image quality.

5.4.1.3 Narrow-Band Filters

These filters can be used over the lens to remove unwanted wavelengths, leaving optimal wavelengths for particular target/background contrasts. For example, if interest resides only in red objects in a particular area, a narrow-band, red filter over the lens will allow only the red targets to be imaged, and the transmissions of other wavelengths will be reduced. However, interest in targets of a single color is rare.

5.4.2 Enhancement During Processing

Although the following "enhancements" are feasible, their success in improving interpretation remains to be shown.

5.4.2.1 Color Separation Negatives

During processing, the multilayered color films can be printed into individual dye layers called Color Separation Negatives. Each single-colored layer will emphasize particular color contrasts. In addition, a single dye layer may have better edge definition than the normal multilayer transparency. This is important for photogrammetrists since they must use edges for mensuration.

5.4.2.2 Color Balance

The overall color balance of color film is under control during processing. A shift in the color balance could improve certain color contrasts.

5.4.3 Enhancement During Interpretation

The use of colored filters and colored lights by the interpreter to enhance certain colors while reducing others on color film are possible

CONFIDENTIAL

enhancing techniques. Although these techniques have been discussed in the literature, they have proven neither practical nor helpful in the overall interpretation of color film.

5.4.3.1 Color Filters

The use of a colored filter over an image, or preferably between the image and light table (Judd, 1954) to enhance a particular color while reducing others, has often been mentioned. This technique, however, reduces the amount of light transmitted through the image and requires the filter to be nearly the same color as the color of interest.

The use of these filters may exaggerate small differences in color, but otherwise are not considered practical (Judd, 1954).

5.4.3.2 Colored Lights

Colored light as a rear illuminant may also be used to enhance certain colors. Although this technique may exaggerate small differences in color, it is not considered practical.

5.5 ILLUMINATION CONDITIONS AFFECTING THE PERCEPTION OF COLOR IMAGERY

The illumination conditions during the interpretation or judging of color imagery, color prints, color maps, etc., are important. Both the intensity level of the illuminant and its SPECTRAL DISTRIBUTION directly affect the perception of colors. For example, if the intensity of the illumination is too low, then colors will be too dim and detail in the image will be difficult to detect. If the illuminant's spectral distribution is not approximately equal in intensity at each wavelength, it will have a predominant color of its own, and thereby tint the colors it is illuminating.

5.5.1 Illuminant Specifications for Light Tables

5.5.1.1 Intensity

The intensity of the illuminant should be variable from below 75 footlamberts (without visible flicker) to a preferred maximum of

CONFIDENTIAL

REF ID: A66719

2500 footlamberts or to, at least, 1500 footlamberts (Boeing, 1969; NRTSC, 1970). For best viewing of color transparencies a level of approximately 900 footlamberts has been recommended with an illuminant COLOR TEMPERATURE of 5000 K (Bartleson and Witzel, 1967). Ideally, the intensity level should neither shift during viewing nor vary across the viewing surface.

5.5.1.2 Spectral Distribution

The spectral distribution of the illuminant should have equal intensity at all visible wavelengths, but minimized below 380 nanometers and above 750 nanometers (Boeing, 1969; Welch, 1967). For color transparencies an illuminant with a spectral distribution matching a color temperature of 5000 K has been recommended (Bartleson and Witzel, 1967). Ideally the spectral distribution should not change during viewing, change when the intensity is varied, or vary across the viewing surface.

Sorens (1967) states that the color of the rear illuminant is not critical because the eye adjusts or adapts to the color of the illuminant. However, for critical color naming, color matching, detecting color differences, or searching for a particular color, the color of the illuminant may indeed affect color judgments.

5.5.2 Illuminant Specifications for Ambient Lighting

The intensity of the ambient illuminant should be variable up to 30 to 35 footcandles (Boeing, 1969) with its SPECTRAL DISTRIBUTION near that of a light source with a COLOR TEMPERATURE of 5000 K.

CONFIDENTIAL

CONFIDENTIAL

5.6 REFERENCES

- Aldrich, R. C., "Forestry Applications of 70 mm Color", Photogrammetric Engineering, 32(5), pp. 802-810 (1966).
- Anderson, R. R., "The Use of Color Aerial Photography in Marshlands and Estuarine Studies", New Horizons in Color Aerial Photography, American Society of Photogrammetry, Falls Church, Virginia (1969).
- Anson, A., "Color Photo Comparison", Photogrammetric Engineering, 32(2), pp. 286-297 (1966a).
- Anson, A., "Comparative Photointerpretation From Panchromatic, Color and Ektachrome IR Photography", Geodesy, Intelligence and Mapping Research and Development Agency, Technical Note 66-3 (1966b), AD 816 833.
- Anson, A., "Photographic Interpretation From Color Aerial Photographs", Manual of Color Aerial Photography, American Society of Photogrammetry, Falls Church, Virginia (1968a).
- Anson, A., "Status of Aerial Color Photography in Government Agencies", U. S. Army Engineer Topographic Laboratories, Technical Brief No. TB-1 (1968b), AD 674 189.
- Anson, A., "The Use of Aerial Color Photography in the Reconnaissance of Soils and Rocks", New Horizons in Color Aerial Photography, American Society of Photogrammetry, Falls Church, Virginia (1969).
- Anson, A., "Color Aerial Photos in the Reconnaissance of Soils and Rocks", Photogrammetric Engineering, 36(4), pp. 343-354 (1970).
- Bartleson, C. J. and Witzel, R. F., "Illumination for Color Transparencies", Photographic Science and Engineering, 11(5), pp. 329-335 (1967).
- Bay, C. A., "Hydrology", Manual of Color Aerial Photography, American Society of Photogrammetry, Falls Church, Virginia (1968).
- Blackband, W. T., "Advanced Techniques for Aerospace Surveillance", AGARD, NATO, CP No. 29 (1968), AD 673 887.
- Blunt, R. M. and Schmeling, W. A., "Study of Psychophysical Factors of Vision and Pyrotechnic Light Sources", Air Force Armament Laboratories, Final Report AFATL-TR-68-17 (1968), AD 842 705.

CONFIDENTIAL

~~CONFIDENTIAL~~

REF ID: A66798

Boeing Company, "Human Engineering Design Guide for Image Interpretation Equipment", Aerospace Group, Seattle, Washington (1969).

Carnegie, D. M., "Interpretation of Color Photography for Range Management", Manual of Color Aerial Photography, American Society of Photogrammetry, Falls Church, Virginia (1968a).

Carnegie, D. M., "Large Scale 70 mm Aerial Color Photography", Photogrammetric Engineering, 35(3), pp. 249-257 (1968b).

Carter, W. D., "Some Uses of Space Photography in Earth Resources Surveys", in Manual of Color Aerial Photography, American Society of Photogrammetry, Falls Church, Virginia (1968).

Ciesla, W. M., Bell, J. C., and Curlin, J. W., "Color Photos and the Southern Pine Beetle", Photogrammetric Engineering, 33(3), pp. 883-888 (1967).

Chaves, J. R. and Schuster, R. L., "Use of Aerial Color Photography In Materials Survey", Highway Research Record No. 63 (1964).

Chaves, J. R. and Schuster, R. L., "Color Photos for Highway Engineering", Photogrammetric Engineering, 34(4), pp. 375-379 (1968).

Cochrane, G. R., "False-Color Film Fails in Practice", Photogrammetric Engineering, 34(11), pp. 1142-1146 (1968).

Colwell, R. N., "Some Practical Applications of Multiband Spectral Reconnaissance", American Scientist, 49(1), pp. 9-36 (1963).

Colwell, R. N., "Testing the Concept and Practical Application of Multiband Reconnaissance: Semi-Annual Status Report", NASA N67-26322 (1967).

Colwell, R. N., "Uses of Aerial Color Photography in Agriculture", in Manual of Color Aerial Photography, American Society of Photogrammetry, Falls Church, Virginia (1968).

Condit, H. R., "Spectral Reflectance of Soil and Sand", New Horizons in Color Aerial Photography, American Society of Photogrammetry, Falls Church, Virginia (1969).

Cooper, R. A., "Applications of Color Aerial Photography in Water Pollution Studies", New Horizons in Color Aerial Photography, American Society of Photogrammetry, Falls Church, Virginia (1969).

~~CONFIDENTIAL~~

CONFIDENTIAL

REF ID: A67803

Dalke, G. W., "Multi-Image Correlation Systems for MGI, Phase I", U. S. Army Topographic Laboratories, DAAK 02-67-C-0435 (1967), AD 833 569.

Eastman Kodak Company, "Photointerpretation and Its Uses", Rochester, New York (1968).

Fischer, W. A., "Color Aerial Photography in Geologic Investigations", Photogrammetric Engineering, 28(1), pp. 133-139 (1962).

Foley, M. E. and Smith, M. L., "Reconnaissance Color Evaluation", Rome Air Development Center, RADC-TR-67-593 (1967), AD 824 036.

Fritz, N. L., "Optimum Methods for Using Infrared Sensitive Film", Photogrammetric Engineering, 33(9), pp. 1128-1138 (1967).

Garra, A. A. and Briggs, S. J., "Image Interpretation State-of-the-Art Review", The Boeing Company, Aerospace Group, Seattle, Washington (1970).

Gausman, H. W., Allen, W. A., Cardenas, R., and Bowen, R. L., "Color Photos, Cotton Leaves, and Soil Salinity", Photogrammetric Engineering, 36(5), pp. 454-459 (1970).

Haack, P. M., "Evaluating Color, Infrared, and Panchromatic Aerial Photos for the Forest Survey of Interior Alaska, Photogrammetric Engineering, 28(4), pp. 592-598 (1962).

Halliday, J., "Applications of Color Aerial Photographs in Topographic Mapping", New Horizons in Color Aerial Photography, American Society of Photogrammetry, Falls Church, Virginia (1969).

Halsey, R. M. and Chapanis, A., "On the Number of Absolutely Identifiable Spectral Hues", JOSA, 41(12), pp. 1057-1058 (1951).

Harris, H. D., Lampton, B. F., and Umback, M. J., "Metric Quality of Color Aerial Photography", Manual of Aerial Color Photography, American Society of Photogrammetry, Falls Church, Virginia (1968).

Harp, E., "Anthropological Interpretation From Color", Manual of Aerial Color Photography, American Society of Photogrammetry, Falls Church, Virginia (1968).

Helegson, G. A., "Water Depth and Distance Penetration", Photographic Engineering, 36(2), pp. 164-172 (1970).

CONFIDENTIAL

CONFIDENTIAL

Helegson, G. A. and Ross, D. S., "Remote Sensor Imaging for Oceanography", *Oceanology International*, September (1967).

Heller, R. C., "Large-Scale Color Photography Samples-Forest Insect Damage", Manual of Color Aerial Photography, American Society of Photogrammetry, Falls Church, Virginia (1968).

Hostrop, B. W. and Kawaguchi, T., "Aerial Color in Forestry", *Photogrammetric Engineering*, 36(6), pp. 555-563 (1971).

Johnson, P. L., "Radioactive Contamination to Vegetation", *Photogrammetric Engineering*, 32(4), pp. 984-990 (1965).

Johnson, P. L. and Atwood, D. M., "Aerial Sensing and Photographic Study of the El Verde Rain Forest, Puerto Rico", *Cold Regions Research and Engineering Laboratory*, RR 250 (1969), AD 703 123.

Judd, D. B., "The Retention of Objects From Photographic Transparencies", *National Bureau of Standards*, NBS Report 3774, 1954.

Kuhl, A. D., "Color and IR Photos for Soils", *Photogrammetric Engineering*, 36(5), pp. 475-482 (1970).

Lauer, D. T., "The Feasibility of Identifying Forest Species and Delineating Major Timber Types by Means of High Altitude Multi-spectral Imagery", *NASA* (1967), N68-17494.

LaViolette, P. E. and Seim, S. E., "Satellites Capable of Oceanographic Data Acquisition -- A Review", *U. S. Naval Oceanographic Office*, Washington, D. C., Technical Report 215 (1959), AD 856 133.

Leibowitz, H. W., "The Human Visual System and Image Interpretation", *Institute for Defense Analysis*, RP-P-319 (1967), AD 817 546.

Letourneaux, P. J., "Improving Quality of Aerial Color Prints", *Photogrammetric Engineering*, 35(2), pp. 147-152 (1969).

Levine, S. H., "Color and B&W Negatives for PI", *Photogrammetric Engineering*, 35(1), pp. 64-71 (1969).

Llewellyn, W. E., "Project Compass Haste (Phases I, V. VII)", *Wright-Patterson Air Force Base*, Final Report, ASD-TR-69-101 (1969), AD 504 715L.

CONFIDENTIAL

CONFIDENTIAL

- Lohse, K. H., "Investigation of Multiband Photographic Techniques, Vol 1", U. S. Army Corps of Engineers, Final Report, DA-44-009-AMC-1218(x), (1956), AD 479 300.
- Ludlum, R. and Van Lopik, J. R., "A Remote Sensing Survey of Areas in Central Coastal Louisiana - Part I - Discussion", Office of Naval Research, ONR 387-039 (1968), AD 808 704.
- Manual of Color Aerial Photography, Edited by Smith, J. T. and Anson, A., American Society of Photogrammetry, Falls Church, Virginia (1968).
- MacLeod, S., Alexander, G., and Meyer, W., "Evaluation of Color Combinations in Reconnaissance Displays", Photographic Science and Engineering, 13(5), pp. 246-251 (1969).
- McDaniel, J. F. and Arntz, J. F., "Aerial Color-Film in Military Photo Interpretation", Photogrammetric Engineering, 25(4), pp. 529-533 (1959).
- Marechal, A., "Camouflage Detection and Black and White Infrared Films for Tactical Aerial Reconnaissance", Naval Reconnaissance Technical Support Center, 201 66-U (1966), AD 813 038L.
- Meyer, M. P. and Calpouzos, L., "Detection of Crop Diseases", Photogrammetric Engineering, 34(10), pp. 554-556 (1968).
- Meyer, M. P. and French, D. W., "Detection of Diseased Trees", Photogrammetric Engineering, 33(3), pp. 1035-1040 (1967).
- Mintzer, O. W., "A Comparative Study of Photography for Soils and Terrain Data", U. S. Army Engineer Topographic Laboratories, TR 38-TR, (1968a), AD 670 012.
- Mintzer, O. W., "Soils", Manual of Color Aerial Photography, American Society of Photogrammetry, Falls Church, Virginia (1968b).
- Mintzer, O. W., "Applications of Color Aerial Photography in Engineering Soils Studies", New Horizons in Color Aerial Photography, American Society of Photogrammetry, Falls Church, Virginia (1969).
- Molineaux, C. E., "Multiband Spectral System for Reconnaissance", Photogrammetric Engineering, 3(1), pp. 131-143 (1965).

CONFIDENTIAL

CONFIDENTIAL

Mott, P. G., "Some Aspects of Color Aerial Photography in Practice and Its Application", The Photogrammetric Record, 5(28), pp. 221-239 (1966).

Myers, L. B. and Ory, T. R., "The Evaluation of Color Imagery and Displays", Rome Air Development Center, RADC-TR-66-326 (1966), AD 877 911.

National Research Council, Remote Sensing With Special Reference to Agriculture and Forestry, National Academy of Sciences (1970).

New Horizons in Color Aerial Photography, American Society of Photogrammetry, Falls Church, Virginia (1969).

Norman, G. G., "Color IR for Inspection of Citrus Trees", Manual of Color Aerial Photography, American Society of Photogrammetry, Falls Church, Virginia (1968).

NRTSC (Naval Reconnaissance and Technical Support Center), "An Investigation Into the Role of Color Photography in Multi-Sensor Reconnaissance, Naval Air System Command, Image Interpretation Technical Bulletin, NAVAIR 10-35TB-513 (1970).

Parry, J. T., Cowan, W. R., and Heginbottom, J. A., "Soil Studies Using Color Photos", Photogrammetric Engineering, 35(1), pp. 44-56 (1969a).

Parry, J. T., Cowan, W. R., and Heginbottom, J. A., "Color for Coniferous Forest Species", Photogrammetric Engineering, 35(7), pp. 669-677 (1969b).

Pease, R. W. and Bowden, L. W., "Making Color Infrared Films a More Effective High Altitude Sensor", Technical Letter NASA-117.

Pestrong, R., "The Evaluation of Multispectral Imagery for a Tidal Marsh Environment", Office of Naval Research, Final Report, NONR-4430(00) (1968), AD 672 188.

Reed, H. B., "Spectral Filtration Research", Air Force Avionics Laboratory, Final Report, AFAL-TR 67-272 (1967), AD 826 978.

Reeves, F. B., "Investigations of the Relative Merits of Black and White Versus Color Aerial Photography for a Large Scale Commercial Mapping Project", New Horizons in Color Aerial Photography, American Society of Photogrammetry, Falls Church, Virginia (1969).

CONFIDENTIAL

CONFIDENTIAL

- Reeves, F. B., "Mensuration: Color Versus Pan", Photogrammetric Engineering, 36(3), pp. 239-244 (1970).
- Schallock, G. W., "Metric Tests of Color Photography", Photogrammetric Engineering, 34(10), pp. 1063-1066 (1968).
- Schneider, W. J., "Water Resources in the Everglades", Photogrammetric Engineering, 32(6), pp. 955-965 (1966).
- Schneider, W. J., "Color Photographs for Water Resources Studies", Photogrammetric Engineering, 34(3), pp. 257-262 (1968).
- Schneider, W. J. and Kolipinski, M. C., "Application of Color Aerial Photography to Water Resources Studies", New Horizons in Color Aerial Photography, American Society of Photogrammetry, Falls Church, Virginia (1969).
- Self, H. C. and Myers, W. S., "A Preliminary Comparison of Lasers With Photography for Finding Tactical Targets", Wright-Patterson Air Force Base, Final Report, AMRL-TR-69-115 (1970), AD 705 652.
- Sheppard, J. J., Stratton, R. H., and Gazley, C., "Pseudocolor As A Means of Image Enhancement", Rand Corporation, P-3988 (1969); AD 681 492.
- Siegel, R. S. and Wright, J., "Multispectral Photographic Reconnaissance", Rome Air Development Center, Final Report, RADC-TR-68-429 (1969).
- Silvestro, F. B., "Object Detection Enhancement", Photogrammetric Engineering, 35(6), pp. 555-559 (1969).
- Silvestro, F. B. and Hammill, H., "Project AMPIRT; Vol III", ARPA, Final Report, RADC-TR-67-206 (1967), AD 382 740L.
- Smith, J., "Color -- A New Dimension in Photogrammetry", Photogrammetric Engineering, 29(6), pp. 999-1013 (1963).
- Soren, A. L., "Principles of Aerial Color Photography", Eastman Kodak Company, Rochester, New York, a paper presented to the 33rd Annual Meeting of American Society of Photogrammetry (1967).
- Specht, M. R., "IR and Pan Films", Photogrammetric Engineering, 36(4), pp. 360-364 (1970).

CONFIDENTIAL

CONFIDENTIAL

REF ID: A66037

Stoeckelar, E. G., "Use of Color Aerial Photography for Pavement Evaluation Studies in Maine", State Highway Commission Maine, Technical Paper 68-6R (1968), PB 183 299.

Strandberg, C. H., "Water Quality Analysis", Photogrammetric Engineering, 32(2), pp. 234-248 (1966).

Swanson, L. W., "Photogrammetric Surveys for Nautical Charting - Use of Color and Infrared Photography", Photogrammetric Engineering, 26(1), pp. 137-141 (1960).

Tactical Air Reconnaissance Center (TAC), "Ektachrome IR Film Test", Shaw AFB, Final Report, TAC-TR-63-57 (1965), AD 475 552L.

Taylor, N., Reed, M., and Hannum, J., "Color Evaluation Program", Electronic Systems Divisions, Final Report, ESD-TDR-64-532 (1964), AD 355 875.

Umback, M. J., "Color for Metric Photogrammetry", Photogrammetric Engineering, 34(3), pp. 265-272 (1968).

Underwood, R. W., "Color Photography From Space", Manual of Color Aerial Photography, American Society of Photogrammetry, Falls Church, Virginia (1968).

Wallace, R. L., Porowski, T. F., and Reilly, T. E., "High Altitude Color Evaluation", Rome Air Development Center, Final Report, RADC-TR-68-373 (1969), AD 395 820.

Wallen, V. R. and Philpotts, L. E., "Disease Assessment With IR-Color", Photogrammetric Engineering, 37(5), pp. 443-446 (1971).

Welch, R., "Comparison of Aerial Films in the Study of the Breidamerkur Glacier Area, Iceland", Photogrammetric Record, 5(28), pp. 287-306 (1967).

Welch, R., "Reflectance Characteristics of a Glacial Landscape and Their Relation to Aerial Photography", New Horizons of Color Aerial Photography, American Society of Photogrammetry, Falls Church, Virginia (1969).

Welch, R. I., "The Use of Color Aerial Photography in Water Resource Management", New Horizons in Color Aerial Photography, American Society of Photogrammetry, Falls Church, Virginia (1969).

CONFIDENTIAL

Wert, S. L. and Roettgering, B., "Douglas-Fir Beetle Survey With Color Photos", Photogrammetric Engineering, 34(12), pp. 1243-1248 (1968).

Whitter, C. A., "Earthquake Damage, Montague Island, Alaska", Manual of Color Aerial Photography, American Society of Photogrammetry, Falls Church, Virginia (1968).

Winterberg, R. P. and Wulfeck, J. W., "Additive Color Photography and Projection for Military Photo Interpretation", Photogrammetric Engineering, 27(2), pp. 450-459 (1961).

Williams, L. G., "The Effects of Target Specification on Objects Fixated During Visual Search", Acta Psychological, 27, pp. 335-360 (1967).

Witmer, R. E., "A Multispectral Survey of a Coastal-Intracoastal Environment", Office of Naval Research, NONR 4761 00, Final Report (1968), AD 667 610.

Woodrow, H. C., "The Use of Color Photography for Large-Scale Mapping", Photogrammetric Record, 33(3), pp. 433-447 (1967).

Yereance, R. A., Easterday, J. L., and Stephan, J. G., "Aerial Photography - Photo Sensors", U. S. Arms Control and Disarmament Agency, ACTIAC Report No. 13 (1967).

Yost, E. F. and Wenderoth, S., "Multispectral Color Aerial Photography", Photogrammetric Engineering, 33(9), pp. 1020-1033 (1967).

Yost, E. F. and Wenderoth, S., "Multispectral Color for Agriculture and Forestry", Photogrammetric Engineering, 37(6), pp. 590-604 (1971).

CONFIDENTIAL

6.0 GLOSSARY

ACTINIC LIGHT

A part of the spectrum (usually infrared, visible, and ultraviolet wavelengths) that causes chemical changes to take place in light-sensitive photographic emulsions. The light that creates images on light-sensitive material. The blue or violet portion of the spectrum would be the actinic band of light for blue- or violet-sensitive photographic materials.

ADDITIVE COLOR SYSTEM

The formation of a color by mixing light of two or more other colors. Most colors may be formed by mixing light of three conveniently selected primary colors (blue, green, and red) in the proper proportions. Some colors may be formed by mixing light of two colors. For example, a mixture of blue and green lights produce cyan, a mixture of blue and red lights produce magenta, and a mixture of green and red lights produce yellow.

COLLIMATION OPTICS

A lens or optics that makes convergent or divergent rays parallel.

COLOR-DIFFERENCE UNIT

A unit used to numerically express the perceptual difference between two colors.

COLOR RENDERING INDEX

A measure of the degree to which perceived colors illuminated by a source compared to the perceived colors when illuminated by a standard source under specified condition. The index ranges from 0 to 100. An index of 100 means that the source affects the appearance of color the same as the standard. An index of 50 is an example of the shift from fluorescent light to incandescent light. The basic problem with this index is understanding what the numbers mean in terms of perceived colors. For examples, how the colors are perceived when illuminated by a source with an index of 83 is difficult to determine.

CONFIDENTIAL

CONFIDENTIAL

REF ID: A66787

COLOR TEMPERATURE

The temperature (in Kelvin) of a "blackbody" radiator whose SPECTRAL DISTRIBUTION matches that of the color being designated.

COMPLEMENTARY COLORS (COMPLEMENTS)

Colors that when combined with another color produce a mixture which color-matches some agreed upon achromatic color. Colors which appear gray when mixed are called complementary.

DIAZO

A photosensitive material with high resolution, and low scattering and sensitivity, which is primarily sensitive to the ultraviolet and blue portions of the spectrum.

DIFFRACTION LIMITED PERFORMANCE

A concept that the ultimate limiting factor in the resolving power of an optical system is determined by the ratio of focal length to diameter of the aperture.

DIFFUSE

Traveling in many different directions.

DYE COUPLERS

Chemicals that form dyes in the emulsion by reacting with the oxidized developer products formed during development. The amount of dye in any one place is proportional to the exposure in that layer of the color film.

GRAININESS

The mealy appearance of the image caused by the clumping together of the silver grains or, in color transparencies, clumping together of the globules.

CONFIDENTIAL

REF ID: A66787R-03/72

GRANULARITY

A term referring to the granular structure of the sensitive emulsion as represented by the measured variation in the distribution of an apparently uniform silver- or dye-globule deposit. It is a scientific concept, whereas graininess is a subjective visual impression created by the granular structure of a photographed material.

INDEX OF REFRACTION

A measure of the power of a substance to refract (to bend a ray of light or change its direction) light. It is the ratio:

$$\frac{\text{sine of incidence angle}}{\text{sine of refraction angle}}$$

when ray is incident from the air side of a glass-air boundary. The greater the directional change, the higher the refractive index, e.g., for air the index is 1.00029 and for glass, from 1.5 to 1.8.

INTEGRATING SPHERE

A sphere whose inside is coated with highly reflective white material used to diffuse collected light and thereby reducing directional effects.

INVARIABLE HUES

Certain wavelengths produce hues which do not change as far out on the retina as saturation is elicited. These wavelengths are 464, 489, and 571 nanometers.

LUMINOUS DENSITY

The optical density of a medium as it appears visually to the standard observer. To measure the visual density of a medium a densitometer is used which duplicates the human photopic curve (\bar{y} of the standard observer).

CONFIDENTIAL

MINUS-BLUE FILTER

A yellow filter that will not transmit blue wavelengths, thus called a minus-blue filter.

NEUTRAL DENSITY FILTER

A filter which absorbs and transmits wavelengths of light equally and gray in color. These filters can be combined (stacked) to provide a wide range of densities.

OPTICAL DENSITY

The logarithm of the reciprocal of the transmittance of a medium.

$$D = \log_{10} \left(\frac{1}{\text{TRANSMITTANCE}} \right) = \log_{10} (\text{opacity})$$

PANCHROMATIC

A film that is nearly equal in sensitivity to all wavelengths of the visual spectrum.

PHOTOPIC VISION

Vision as it occurs when the eye is light-adapted and can fully discriminate all colors.

SCOTOPIC VISION

Vision experienced by the normal eye when adapted to very low levels of illumination. The maximum of the relative spectral visual sensitivity is shifted to 510 nm, and the spectrum is seen uncolored. The rod receptors in the retina are considered to be the active elements under these conditions.

SILVER HALIDE

A silver compound, sensitive to light, and used in film emulsions to form a latent image.

CONFIDENTIAL

SOLID ANGLE

The angle measured by the ratio of the surface of the portion of a sphere enclosed by the conical surface forming the angle, to the square of the radius of the sphere.

SPECTROPHOTOMETRIC

Referring to the measurement of the amount of light at each wavelength or within narrow bands of wavelengths.

SPECTRAL DISTRIBUTION

The amounts of a radiant quantity for the various wavelengths of the spectrum. See Figures 3.5 and 3.6 for examples.

SPECTRAL ENERGY DISTRIBUTION

The relative energy (amount of light) emitted from a source at each wavelength.

SPECULAR

In sensitometry, applied to a measurement made by collimated or essentially parallel light rays; referring to reflection, or transmission without scattering or diffusion.

STEREOPSIS

A binocular ability to see depth due to a disparity of the two retinal images of a scene.

VISUAL DENSITY

The density of a medium as it appears visually to the standard observer. To measure the visual density of a medium a densitometer is used which duplicates the human photopic curve (\bar{y} of the standard observer).

CONFIDENTIAL

CONFIDENTIAL

VIGNETTING

A gradual reduction in density of parts (generally at the edges and corners) of a photographic image caused by stopping some of the rays entering the lens. Thus, a lens mounting may interfere with the extreme oblique rays.

CONFIDENTIAL

CONFIDENTIAL

NPIC/R-03/72

7.0 SUGGESTED READINGS

The following listing represents suggested reading by selected topic. Within a topic, references are listed in order of increasing technical difficulty.

7.1 GENERAL REFERENCES

Smith, J. T., Manual of Color Aerial Photography, 1st ed., American Society of Photogrammetry, Falls Church, Virginia (1968).

Burnham, R. W., Hanes, R. M., and Bartleson, C. J., Color: A Guide to Basic Facts and Concepts, John Wiley and Sons, New York, New York (1963).

Evans, R. M., An Introduction to Color, 1st ed., John Wiley and Sons, New York (1948).

Billmeyer, F. W., Jr. and Saltzman, M., Principles of Color Technology, 1st ed., Interscience Publishers, New York (1966).

Evans, R. M., Hanson, W. T., and Brewer, W. L., Principles of Color Photography, John Wiley and Sons, New York (1953).

Judd, D. B. and Wyszecki, G., Color in Business, Science and Industry, 2nd ed., John Wiley and Sons, New York (1963).

Committee on Colorimetry - Optical Society of America, The Science of Color, Thomas Y. Crowell Company, New York (1953).

Wyszecki, G. and Stiles, W. S., Color Science: Concepts and Methods, Quantitative Data and Formulas, John Wiley and Sons, New York (1967).

CONFIDENTIAL

7.2 ANATOMY AND PHYSIOLOGY OF COLOR VISION

Mueller, C. G. and Rudolf, M., Light and Color, Life Sciences Library, New York (1966).

Burnham, R. W., Hanes, R. M., and Bartleson, C. J., Color: A Guide to Basic Facts and Concepts, John Wiley and Sons, New York (1963).

Gregory, R. L., Eye and Brain, World University Library, McGraw-Hill, New York (1966).

Graham, C. H., Vision and Visual Perception, John Wiley and Sons, New York, New York (1965).

LeGrande, Y., Light, Color, and Vision, Chapman and Hall Ltd., London, England (1968).

Kronfeld, P. C., McHugh, G., and Polyak, S. L., The Human Eye in Anatomical Transparencies, Baush and Lomb Press, Rochester, New York (1943).

Southall, J.R.C., Physiological Optics, Dover Publications, Inc., New York (1937).

CONFIDENTIAL

7.3 PSYCHOLOGICAL AND PSYCHOPHYSICAL ASPECTS OF COLOR VISION

Mueller, C. G. and Rudolf, M., Light and Color, Life Science Library, New York (1966).

Burnham, R. W., Hanes, R. M., and Bartleson, C. J., Color: A Guide to Basic Facts and Concepts, John Wiley and Sons, New York, New York (1963).

Evans, R. M., An Introduction to Color, 1st ed., John Wiley and Sons, New York (1948).

Gregory, R. L., Eye and Brain, World University Library, McGraw-Hill, New York (1966).

Graham, C. H., Vision and Visual Perception, John Wiley and Sons, New York, New York (1965).

Committee on Colorimetry - Optical Society of America, The Science of Color, Thomas Y. Crowell Company, New York (1953).

Wysezecki, G., and Stiles, W. S., Color Science: Concepts and Methods, Methods, Quantitative Data and Formulas, John Wiley and Sons, New York New York (1967).

LeGrande, Y., Light, Color, and Vision, Chapman and Hall, Ltd., London, England (1968).

CONFIDENTIAL

7.4 COLOR VISION TESTS

Burnham, R. W., Hanes, R. M., and Bartleson, C. J., Color: A Guide to Basic Facts and Concepts, John Wiley and Sons, New York, New York (1963).

Lewis, M. F. and Ashby, F. K., "Diagnostic Tests of Color Defective Vision Annotated Bibliography, 1956-66", AM 67-8, Federal Aviation Administration, Office of Aviation Medicine, Washington, D. C. (1967).

Garra, A. A. and Briggs, S. J., Image Interpretation - State of the Art Review, The Boeing Company, Aerospace Group, Seattle, Washington (1970).

Lakowski, R., "Psychological Variables in Colour Vision Testing", Paper #52, read at the First Institute Congress on Colour, June 1969, Stockholm, Sweden, AD 695 343.

Farnsworth, D., The Farnsworth-Munsell 100-Hue Test for the Examination of Color Discrimination Manual, Munsell Color Company, Baltimore, Maryland, Rev. Ed. (1957).

Judd, D. B., "Color Blindness and the Detection of Camouflage", Science, 97, pp. 544-546 (1943).

Judd, D. B., "Facts of Color Blindness", Journal of the Optical Society of America, 33(6), pp. 294-307 (1943).

CONFIDENTIAL

REF ID: A66803

7.5 PHYSICS OF COLOR

Mueller, C. G. and Rudolf, M., Light and Color, Life Science Library, New York (1966).

Burnham, R. W., Hanes, R. M., and Bartleson, C. J., Color: A Guide to Basic Facts and Concepts, John Wiley and Sons, New York (1963).

Evans, R. M., An Introduction to Color, 1st ed., John Wiley and Sons, New York (1948).

Billmeyer, F. W., Jr. and Saltzman, M., Principles of Color Technology, 1st ed., Interscience Publishers, New York (1966).

"Light", Scientific American, 219(3), September (1968).

Judd, D. B. and Wyszecki, G., Color in Business, Science and Industry, 2nd ed., John Wiley and Sons, New York (1963).

Committee on Colorimetry - Optical Society of America, The Science of Color, Thomas Y. Crowell Company, New York (1953).

Wyszecki, G. and Stiles, W. S., Color Science: Concepts and Methods, Quantitative Data and Formulas, John Wiley and Sons, New York (1967).

CONFIDENTIAL

7.6 COLOR SYSTEMS

Smith, J. T., Manual of Color Aerial Photography, 1st ed., American Society of Photogrammetry, Falls Church, Virginia (1968).

Burnham, R. W., Hanes, R. M., and Bartleson, C. J., Color: A Guide to Basic Facts and Concepts, John Wiley and Sons, New York, New York (1963).

Kelly, K. L., "A Universal Color Language", Color Engineering, 3(2), pp. 16-21 (1965).

Evans, R. M., An Introduction to Color, 1st ed., John Wiley and Sons, New York (1948).

Billmeyer, F. W., Jr. and Saltzman, M., Principles of Color Technology, 1st ed., Interscience Publishers, New York (1966).

Newhall, S. M., Nickerson, D., and Judd, D. B., "Final Report of the O.S.A. Subcommittee on the Spacing of the Munsell Colors", Journal of the Optical Society of America, 33(7), pp. 385-418 (1943).

Judd, D. B. and Kelly, K. L., The ISCC-NBS Method of Designating Colors and A Dictionary of Color Names, National Bureau of Standards Circular 553 (1955).

Richter, M., "The Official German Standard Color Chart", Journal of the Optical Society of America, 45(3), pp. 223-226 (1955).

Judd, D. B., Chamberlin, G. J., and Haupt, G. W., "Ideal Lovibond Color System", Journal of the Optical Society of America, 52(7), pp. 813-819 (1962).

Gourley, J., Rib, H. T., and Miler, R. D., "Automatic Technique for Abstracting Color Description from Aerial Photography", Photographic Science and Engineering, 12(1), pp 27-35 (1968).

Committee on Colorimetry - Optical Society of America, The Science of Color, Thomas Y. Crowell Company, New York (1953).

Wyszecki, G. and Stiles, W. S., Color Science: Concepts and Methods, Quantitative Data and Formulas, John Wiley and Sons, New York (1967).

CONFIDENTIAL

7.7 COLORIMETRY AND COLOR DENSITOMETRY

Billmeyer, F. W., Jr. and Saltzman, M., Principles of Color Technology, 1st ed., Interscience Publishers, New York (1966).

Billmeyer, F. W., Jr., "Current American Practice in Color Measurement", Applied Optics, 8(4), pp. 737-750 (1969).

Erhart, F. H., ed., Principles of Color Sensitometry, 2nd ed., Society of Motion Picture and Television Engineers, New York (1963).

Onley, J. W., "Analytical Densitometry for Color Print Evaluation", Journal of the Optical Society of America, 50(2), pp. 177-182 (1960).

Powers, S. A. and Miller, I. E., "Pitfalls of Color Densitometry", Photographic Science and Engineering, 7(1), pp. 59-67 (1963).

James, T. H., ed., Theory of the Photographic Process, 3rd ed., MacMillan Company, New York (1966), "The Sensitometry of Color Films and Papers" (J. L. Simonds), pp. 450-463.

Wyszecki, G. and Stiles, W. S., Color Science: Concepts and Methods, Quantitative Data and Formulas, John Wiley and Sons, New York (1967).

Nimeroff, I., Colorimetry, National Bureau of Standards Monograph 104 (1968).

Nimeroff, I., "Propagation of Errors in Tristimulus Colorimetry", Journal of the Optical Society of America, 50(2), pp. 177-182 (1960).

Nimeroff, I., "Propagation of Errors in Spectrophotometric Colorimetry", Journal of the Optical Society of America, 43(6), pp. 531-533 (1953).

CONFIDENTIAL

7.8 COLOR AERIAL RECONNAISSANCE

Smith, J. T., Manual of Color Aerial Photography, 1st ed., American Society of Photogrammetry, Falls Church, Virginia (1968).

New Horizons in Color Aerial Photography, American Society of Photogrammetry, Falls Church, Virginia (1969).

Anson, A., "Status of Aerial Color Photography in Government Agencies", U. S. Army Engineer Topographic Laboratories, Technical Brief Report No. 1 (1968), AD 674 189.

Avery, T. E., Interpretation of Aerial Photographs, 2nd ed., Burger Publishing Company, Minneapolis, Minnesota (1968).

Llewellyn, W. E., "Project Compass Haste (Phases I, V, VII)", Wright-Patterson Air Force Base, Final Report, ASD TR-69-101 (1969), AD 504 715L.

Garra, A. A., and Briggs, S. J., "Image Interpretation State-of-the-Art Review", The Boeing Company, Aerospace Group, Seattle, Washington (1970).

National Research Council, Remote Sensing With Special Reference to Agriculture and Forestry, National Academy of Sciences (1970).

Evans, R. M., Hanson, W. T., and Brewer, W. L., Principles of Color Photography, John Wiley and Sons, New York (1953).

Jensen, N., Optical and Photographic Reconnaissance System, John Wiley and Sons, New York (1968).

Jones, T. H., ed., Theory of the Photographic Process, 3rd ed., MacMillan Company, New York (1966).

Mac Adam, D. L., "Color Science and Color Photography", Physics Today, 20(1), pp. 27-39 (1967).

Zwick, D., "Colour Granularity and Graininess", Journal of Photographic Science, 11(5), pp. 269-275 (1963).

Forst, D. J., Hughes, J. G., Pittman, G. A., and Wallace, R. L., "Color Tone Reproduction - Practice Manual", Air Force Avionics Laboratory, Final Report-67-164(1969), AD 848 115.

Forst, D. J., Hughes, J. G., Pittman, G. A., and Wallace, R. L., "Color Tone Reproduction - Theory Manual", Air Force Avionics Laboratory, Final Report-67-164(1968), AD 829 676.

CONFIDENTIAL

REF ID: A66307

8.0 INDEX

A

| | <u>Page</u> |
|-------------------------------------------|-------------|
| Absorption, of light | 50 |
| Accommodation | 4 |
| Acquired color defects | 36 |
| Adaptation | 24 |
| Additive | 54 |
| Additive color separations | 103 |
| Additive color separations, advantages | 127 |
| Additive color separations, disadvantages | 128 |
| Aerial films | 100 |
| Aerial perspective | 26 |
| After images (positive and negative) | 19 |
| Analytical densitometry | 87 |
| Anatomy of the eye | 3 |
| Anomalous trichromats | 35 |
| Antivignetting filters | 143 |
| Aqueous humor | 4 |
| Area effect | 16 |
| Arbitrary three-filter densities | 86 |
| Atmospheric attenuation | 110, 125 |
| Atmospheric turbulence | 108 |

B

| | |
|--------------------------|-----|
| Bezold-Brücke effect | 10 |
| Binocular cues of depth | 26 |
| Black and white infrared | 130 |

CONFIDENTIAL

| | <u>Page</u> |
|-----------------------------------------|-------------|
| Black and white infrared, advantages | 130 |
| Black and white infrared, disadvantages | 130 |
| Black content | 65 |
| Blind spot | 5, 6 |
| Bloom | 125 |
| Brightness | 9, 17 |
| Burnham-Clark-Munsell color-memory test | 39 |

C

| | |
|-------------------------------------------|----------|
| Campimeter test | 40 |
| Camouflage detection film | 101, 126 |
| Change detection | 140 |
| Choroid | 4 |
| Chroma | 60 |
| Chromatic aberration | 21 |
| Chromatic adaptation | 24 |
| Chromastereopsis | 28 |
| Chromaticity coordinates | 64 |
| CIE | 62 |
| CIE color difference unit | 77 |
| Ciliary body | 4 |
| Collimation optics | 75 |
| Color adaptation | 24 |
| Color aerial photography | 94 |
| Color constancy | 20 |
| Color capabilities and skills | 29 |
| Color changes due to altitude increases | 110 |
| Color and color photography, reproduction | 53 |
| Color densitometer | 83 |

| | <u>Page</u> |
|------------------------------------------------------------------|-------------|
| Colormetric densities | 86 |
| Color differences and tolerances | 81 |
| Color, effect on cues of depth | 28 |
| Color fidelity | 108 |
| Color fields | 13 |
| Color films | 99 |
| Color films, advantages | 124 |
| Color films, disadvantages | 125 |
| Color film and color imagery techniques, operational findings | 124 |
| Color film mensuration | 138 |
| Color film processing, tolerance in | 116 |
| Color film, theoretical advantage of | 122 |
| Color film theory | 94 |
| Color zones | 13 |
| Colorimeter | 75 |
| Colorimeter, Lovibond | 65 |
| Colorimeters, visual tristimulus | 75 |
| Colorimetric data and error analysis, treatment of | 77 |
| Colorimetry | 70 |
| Colorimetry, visual | 75 |
| Color infrared film | 101, 126 |
| Color infrared film, advantages of | 126 |
| Color infrared film, disadvantages of | 127 |
| Color matching functions | 64 |
| Color, measurement of | 70 |
| Colors, metameric | 78 |
| Color normals | 9 |
| Color perception, effects of age on | 36 |
| Color perceptual phenomena | 16 |
| Color, physics of | 46 |

CONFIDENTIAL

| | <u>Page</u> |
|-------------------------------------------------------------------|-------------|
| Color, psychophysical aspects of | 46 |
| Color rendering | 83 |
| Color rendering index | 83 |
| Color reversal film | 94 |
| Color reproduction, additive method of | 54 |
| Color reproduction, subtractive method of | 54 |
| Color systems | 60 |
| Color versus black and white film, experimental comparisons of | 123 |
| Color vision defects, congenital versus acquired | 36 |
| Color vision defects, types of | 35 |
| Color vision tests | 37 |
| Complements | 19, 96 |
| Cones | 6 |
| Congenital color defects | 36 |
| Constant hues | 10 |
| Convergence | 26 |
| Cornea | 4 |
| Cyan | 54 |

D

| | |
|-------------------------------|----|
| Dark adaptation | 24 |
| Defective color vision | 34 |
| Densitometer, color | 83 |
| Densitometry, analytical | 85 |
| Densitometry, integral | 85 |
| Densitometric Munsell | 69 |
| Density, specular and diffuse | 85 |

CONFIDENTIAL

CONFIDENTIAL

| | <u>Page</u> |
|----------------------------------|-------------|
| Density, visual or luminous | 86 |
| Depth perception and color | 25 |
| Depth, perceptual uses of | 25 |
| Deuteranomals | 35 |
| Deuteranopes | 35 |
| Diagram, CIE | 63 |
| Dichromatism | 35 |
| Dichromats | 35 |
| Diffuse density | 85 |
| DIN | 67 |
| Dominant wavelength | 64 |
| Dunkelstufe | 67 |
| Dyes | 54 |
| Dye coupler | 94 |
| Dye globules, optical density of | 115 |

E

| | |
|-------------------------------------------------------------------------------------------------------|-----|
| Edge effect | 17 |
| Effects of atmosphere and sun angle | 108 |
| Effects of lens and lens aberrations | 114 |
| Effects of platform and camera vibration | 114 |
| Effects of target and acquisition parameters on color aerial photography and color per- ception | 103 |
| Enhancement of color film during processing | 144 |
| Enhancement of color film during acquisition | 143 |
| Enhancement during interpretation | 143 |
| Electromagnetic waves | 46 |
| Equivalent neutral density | 86 |

CONFIDENTIAL

CONFIDENTIAL

| | <u>Page</u> |
|-------------------------------------|-------------|
| Equivalent neutral printing density | 88 |
| Eye muscles | 3 |
| Eye structure | 3 |

F

| | |
|--------------------------------------------------------------------|----------|
| False color films | 101, 126 |
| Farbton | 67 |
| Farnsworth-Munsell 100-Hue Test | 38 |
| Field (geometric) of color | 13 |
| Films/processing parameters and color film variance, effects of | 116 |
| Filters, antivignetting | 143 |
| Fovea centralis | 4 |
| Full color content | 65 |

G

| | |
|-------------------------|-----|
| Ganglion fiber layer | 6 |
| Geologic features | 138 |
| Geometric metamerism | 81 |
| Granularity | 114 |
| Granularity, effects of | 114 |
| Ground resolution | 108 |

CONFIDENTIAL

CONFIDENTIALH

| | <u>Page</u> |
|-----|-----------------------|
| Hue | 11, 12, 13, 29, 53 |

I

| | |
|----------------------------------------------------------------------|---------|
| Identification, color | 32 |
| Illusions | 16 |
| Illuminant, specifications | 46, 145 |
| Illuminants | 62 |
| Illumination conditions affecting the perception of color imagery | 145 |
| Index of refraction (of air) | 108 |
| Infrared, color | 101 |
| Instrumental metamerism | 81 |
| Integral densitometry | 85 |
| Integral printing densities | 85 |
| Integral spectral densities | 87 |
| Integrating sphere | 75 |
| Interposition of colors | 25 |
| Interpretation, enhancement during | 144 |
| Interpretation techniques and color films | 139 |
| Inter-Society Color-Council Color Aptitude Test (ISCC-CAT) | 38 |
| Invariable hues | 10, 16 |
| Invariant hues | 10 |
| Iris | 4 |
| Irradiation | 21 |
| ISCC-NBS color system | 69 |

CONFIDENTIAL

~~CONFIDENTIAL~~L

| | <u>Page</u> |
|--------------------------------------------|-------------|
| Latent image | 96 |
| Lateral geniculate body | 9 |
| Lens and lens aberrations | 114 |
| Lens (of the eye) | 4 |
| Light | 46 |
| Light adaptation | 24 |
| Lightness | 53 |
| Light tables, illuminant specification for | 145 |
| Linear perspective | 26 |
| Lovibond | 65 |
| Luminous density | 86 |

M

| | |
|------------------------------|------|
| Mach bands | 21 |
| Macular area | 4 |
| Maerz and Paul | 70 |
| Magenta | 54 |
| Magnification, of color film | 139 |
| Matching, color | 32 |
| Memory, color | 30 |
| Mensuration of color films | 138' |
| Metameric pairs | 78 |
| Metamerism | 78 |
| Metamerism, geometric | 81 |
| Metamerism, instrumental | 81 |
| Methuin | 70 |
| Minus-blue filter | 143 |

CONFIDENTIAL

CONFIDENTIAL

| | <u>U</u> | <u>Page</u> |
|-------------|----------|-------------|
| Unique hues | | 11 |

| | <u>V</u> | |
|---------------------------------|----------|----------|
| Value, Munsell | | 60 |
| Vegetation types | | 133 |
| Vibration | | 114 |
| Vignetting | | 125, 139 |
| Visual colorimetry | | 75 |
| Visual cortex | | 9 |
| Visual densities | | 86 |
| Visual spectrum | | 14, 46 |
| Visual tristimulus colorimeters | | 75 |
| Vitreous humor | | 4 |
| Villalobos | | 70 |

| | <u>W</u> | |
|---------------------------|----------|-----|
| Water | | 136 |
| Wavelength | | 46 |
| Wavelength discrimination | | 30 |
| White content | | 65 |

| | <u>Y</u> | |
|------------|----------|----|
| Yellow dye | | 54 |

CONFIDENTIAL

CONFIDENTIAL

CONFIDENTIAL