

TOP SECRET

Copy 36  
24 Pages



June 1965

PHOTOGRAPHIC INTERPRETATION REPORT

# MOSCOW-AREA INTERFEROMETERS: A COMPARATIVE STUDY



CIA



DIA

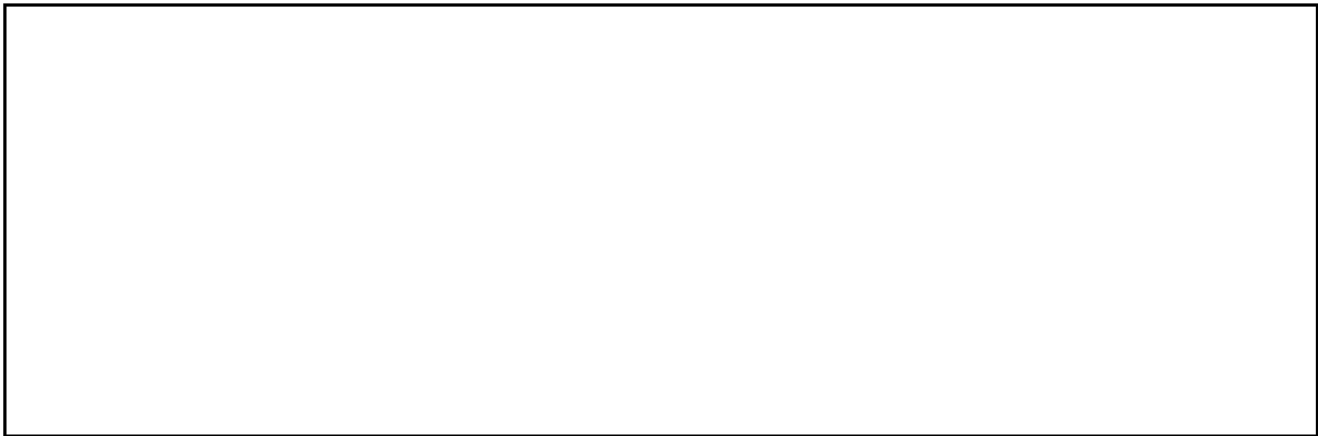

NATIONAL PHOTOGRAPHIC INTERPRETATION CENTER

25X1A

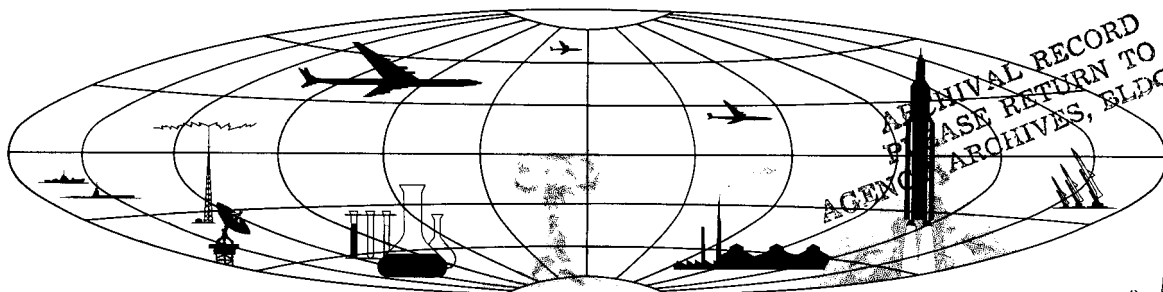

APPROVAL RECORD  
PLEASE RETURN TO  
AGENCY ARCHIVES, BLDG.

Declass Review by NIMA/DOD

TOP SECRET

231452/2

GROUP 1  
Excluded from automatic  
downgrading and declassification

K1

Approved For Release 2003/11/21 : CIA-RDP78T04759A001400010047-1

25X

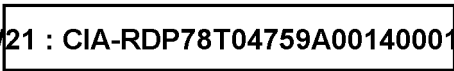
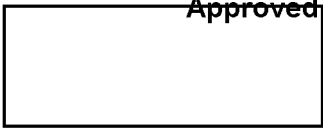

PHOTOGRAPHIC INTERPRETATION REPORT

# MOSCOW-AREA INTERFEROMETERS: A COMPARATIVE STUDY

June 1965

NATIONAL PHOTOGRAPHIC INTERPRETATION CENTER

Approved For Release 2003/11/21 : CIA-RDP78T04759A001400010047-1

TOP SECRET

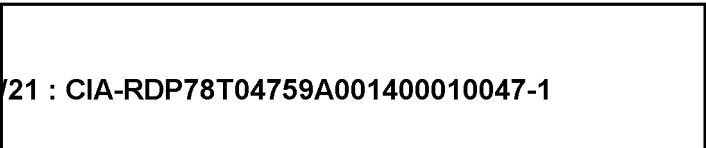

25

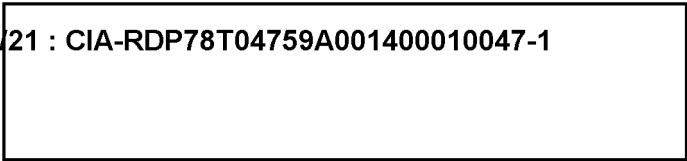

PREFACE

The cutoff date for photography and interpretation in this report is 1 January 1965, except for the utilization of photography from Mission [redacted] in interpreting Kozelsk ICBM Complex Launch Site F and of photography from [redacted] for the Talsi site.

25X1D

25X1D

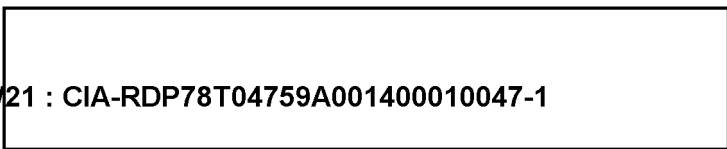

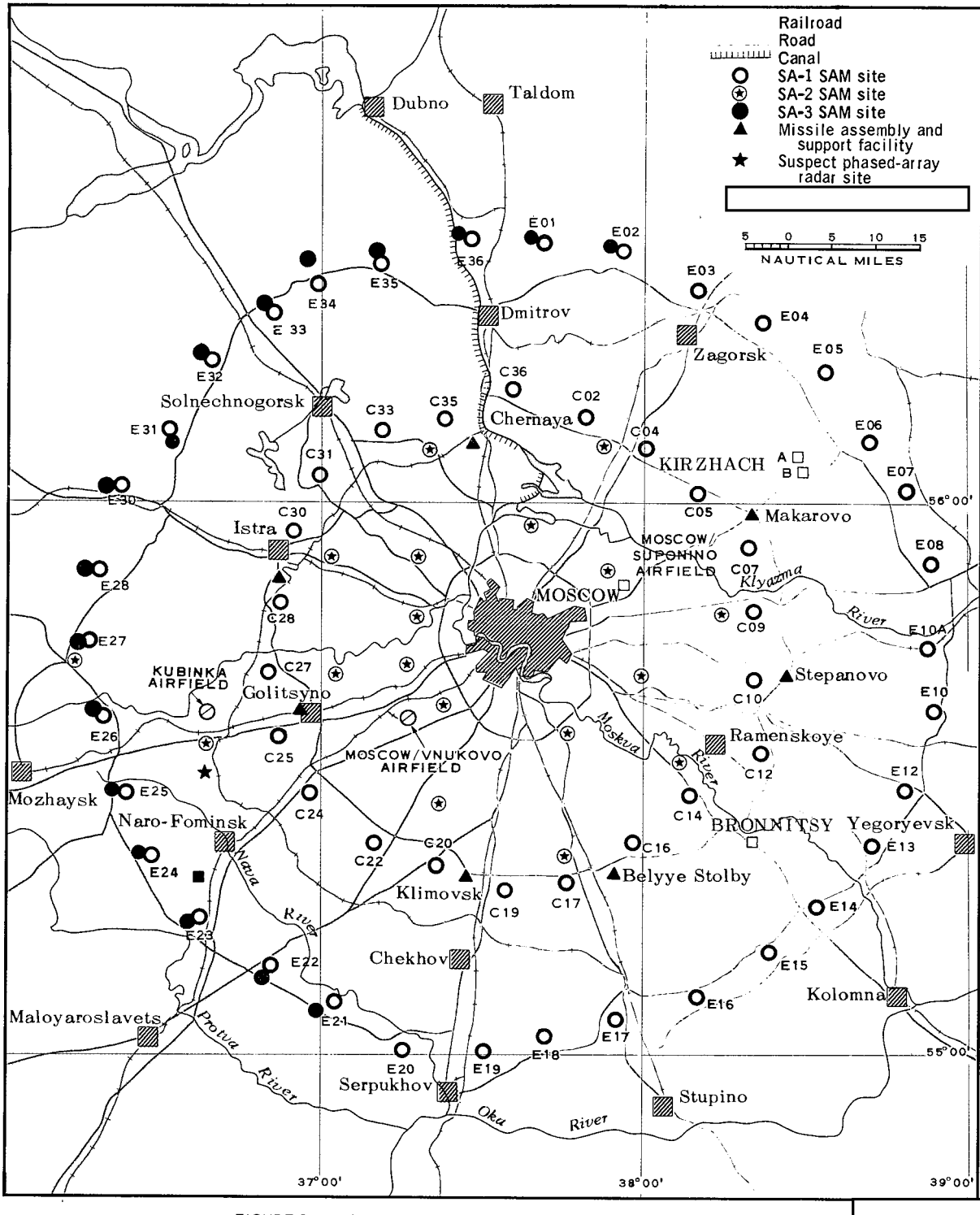

25X1B

FIGURE 1. LOCATION OF MOSCOW-AREA INTERFEROMETER SITES.



**INTRODUCTION**

This report describes 4 interferometer sites in the Moscow area, and compares these facilities with other interferometers previously noted at deployed ICBM complexes and at the Sary-Shagan Antimissile Test Center (SSATC).

**Moscow-Area Interferometers**

Six plus-shaped configurations, identified as interferometric tracking facilities, have been found at 4 sites in the Moscow area (Figure 1). Four of these plus-shaped configurations are situated west of the town of Kirzhach, where 2 plus-shaped configurations have been placed together with a 50-percent overlap to constitute 1 interferometer site (Kirzhach Site A), and 2 other plus-shaped configurations have been placed side by side where they apparently operate together as a second facility (Kirzhach Site B).

At the 2 remaining locations, Moscow/Suponino Airfield and Bronnitsy, there are singly deployed plus-shaped configurations that resemble the more usual types of Soviet interferometers.

It appears that all of the Moscow-area interferometers are special-purpose tracking facilities having no direct connection with interferometer sites at SSATC or at deployed ICBM complexes. This conclusion is based on such comparative considerations as base-leg orientation and overall site appearance; however, the basic interferometer pattern at Kirzhach Site B and at Bronnitsy is similar to that found at certain of the SSATC sites.

**Identification and Comparison of Interferometer Sites**

It is somewhat paradoxical that the overall geometric configuration of an interferometer site is quite large and easily detectable while, at the same time, the individual components

that define the electronic design parameters are extremely small and hardly detectable at all, even under the best of photographic circumstances. This situation arises, both from the high frequencies employed and from the absence of any need for large mechanically steerable equipment--reflector screens, tracking dishes, and the like--since the actual tracking is done electronically by obtaining the phase shift between 2 or more receivers (Figure 2).

Using pure interferometric techniques, it is not necessary to have a transmitter collocated with the receiver. In fact, if the target to be tracked possesses a beacon transmitter, it is not necessary to incorporate any terrestrial transmitter into the system, which would then be said to be "passive."

However, it is equally possible to have a range-rate device. This could still employ interferometric techniques and could also possess the same geometric shape as a passive interferometer (although it is also possible for the 2 legs to form an L, instead). Such a system would most likely employ a "central station," placed at the vertex, which would contain both a transmitter and a receiver. This type of instrumentation could be described as "semi-active" in view of the utilization of a transmitter at the central station. More pure triangulation is used in a range-rate device because of its direct radar range capabilities.

Since it is not possible to identify specific instrumentation components on the photography utilized in the preparation of this report, and since only partial success was obtained in determining instrument positions, the categorization of the interferometric facilities was accomplished largely on the basis of their gross overall configuration. However, while appearance and even mensuration may compare favorably, this alone is not sufficient to deter-



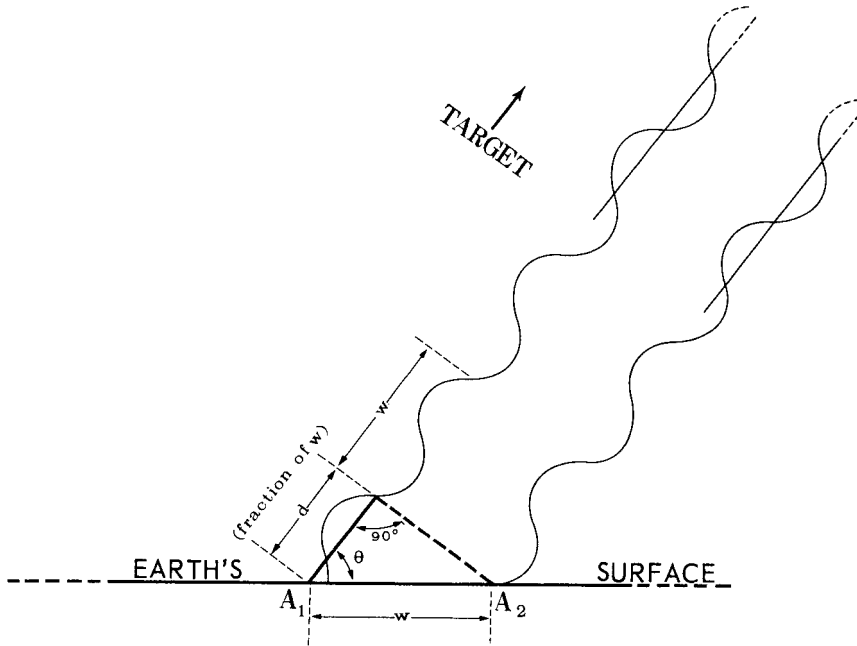

A radio-frequency interferometer is a device used to track an aircraft, missile, or satellite by *phase comparison techniques*-- that is, by determining the changing angle of a radio signal from the target as it passes overhead.

In its simplest form, an interferometer requires only a pair of receiving antennas, A1 and A2, and a continuous radio signal from the target. This signal can originate either from a transmitter on board the target, or from a ground-based transmitter and be reflected from the target--the principle remains the same. In the illustration, the separation between the 2 ground antennas,  $w$ , has been made equal to the *wavelength*,  $w$ , of the radio signal.

In operation, the target's signals arrive at some unknown angle,  $\theta$ , and reach A1 later than A2, thus travelling an extra distance,  $d$ . This extra distance obviously depends on the *direction* from which the target signals are coming; and the ratio of that dis-

tance to the antenna separation is  $d/w$ , which is the cosine of the angle  $\theta$ . The target's direction angle,  $\theta$ , can therefore be determined from the known value  $w$  and from  $d$ . And  $d$  is measured electrically by noting the *phase delay* between the signals at the 2 antennas--which translates into the fraction of wavelength  $d$  contains.

This measurement gives only the *direction angle* of the target with respect to the line between the 2 antennas. However, by adding a similar measurement from antennas placed perpendicularly to the first set, the *line of sight* to the target can be established--and the familiar plus-shaped configuration is formed.

In actual practice, A1 and A2 are spaced closer and 1 or more other antennas spaced farther out to improve precision. Also, the + shape could as well be  $\perp$ , or  $\square$

FIGURE 2. THE RADIO-FREQUENCY INTERFEROMETER: HOW IT WORKS.

mine precise function or to certify positively to the technical operating identity of similar-appearing facilities. In short, there is no guarantee that what looks alike also works alike.

Some of the interferometer configurations appear to have central stations or positions and some do not (Table 1). However, all of the configurations have been identified as interferometers because it is believed they employ interferometer techniques to some degree.

### KIRZHACH INTERFEROMETER INSTALLATION

The Kirzhach interferometer installation contains 2 operational sites, a northern (Site A) at 56-05-05N 38-29-25E and a southern (Site B) at 56-04-00N 38-30-25E. The entire installation has been previously described in NPIC/R-918/64, November 1964, 1/ but more recent photography allows an updating of that information together with some refinement of details, mensuration, and construction progress.

#### SITE A

Site A (Figures 4 and 5) was previously called a "Suspect Interferometer Site," 1/ but more recent photographic coverage (Mission [redacted] now makes it possible to definitely identify this facility as an interferometer, primarily through the observation of 2 environmental-dome coverings, 1 at the terminus of an interferometer leg (Figure 5, item H) and the other on the large building in the unidentified-activity area (item V). The equipment housed in the second dome could quite reasonably be an acquisition tracking or a continuous wave (CW) illumination antenna.

Site A is quite large and is unique in appearance (Figure 3), there being no known similar sites in the USSR; it was most probably built for a single specific function. There is some evidence that it may be a range-rate

device, a possibility suggested by the building situated at the precise point of perpendicular bisection of each pair of legs. These 2 buildings each have a probable antenna on the roof and they may equate to central stations. In addition, there are probable antennas on all of the leg termini buildings (Figure 5, items D-K), including the 1 with an environmental-dome covering (item H).

#### SITE B

Site B (Figure 6) is known as a twin interferometer site, and is composed of 2 plus configurations placed some 1,545 feet apart. However, the road network and general site appearance suggest that they operate together as a single facility. Photography through [redacted] shows that this site is still under construction and that there has been no significant change in its configuration since it was previously described 1/ except for the positions at the leg termini (items A-D and G-J), which have been built up with earth and now permit more accurate mensuration.

The leg extensions at the northern interferometer are now all quite definite although only half of 1 of the full extensions can be measured. This distance (Figure 5, items S-Y) appears to be 9,745 feet. There is a small light-toned object, possibly an antenna, at the western terminus (Figure 5, item S). If this extension is equal in all 4 directions, then the overall length of each leg would be about 19,500 feet.

There are no signs of any extensions at the southern interferometer.

### BRONNITSY INTERFEROMETER SITE

This site (Figure 7) is 3 nautical miles (nm) southeast of Bronnitsy and 30nm southeast of the Kremlin. With only a few buildings in

25X1D

25X1D

25X1

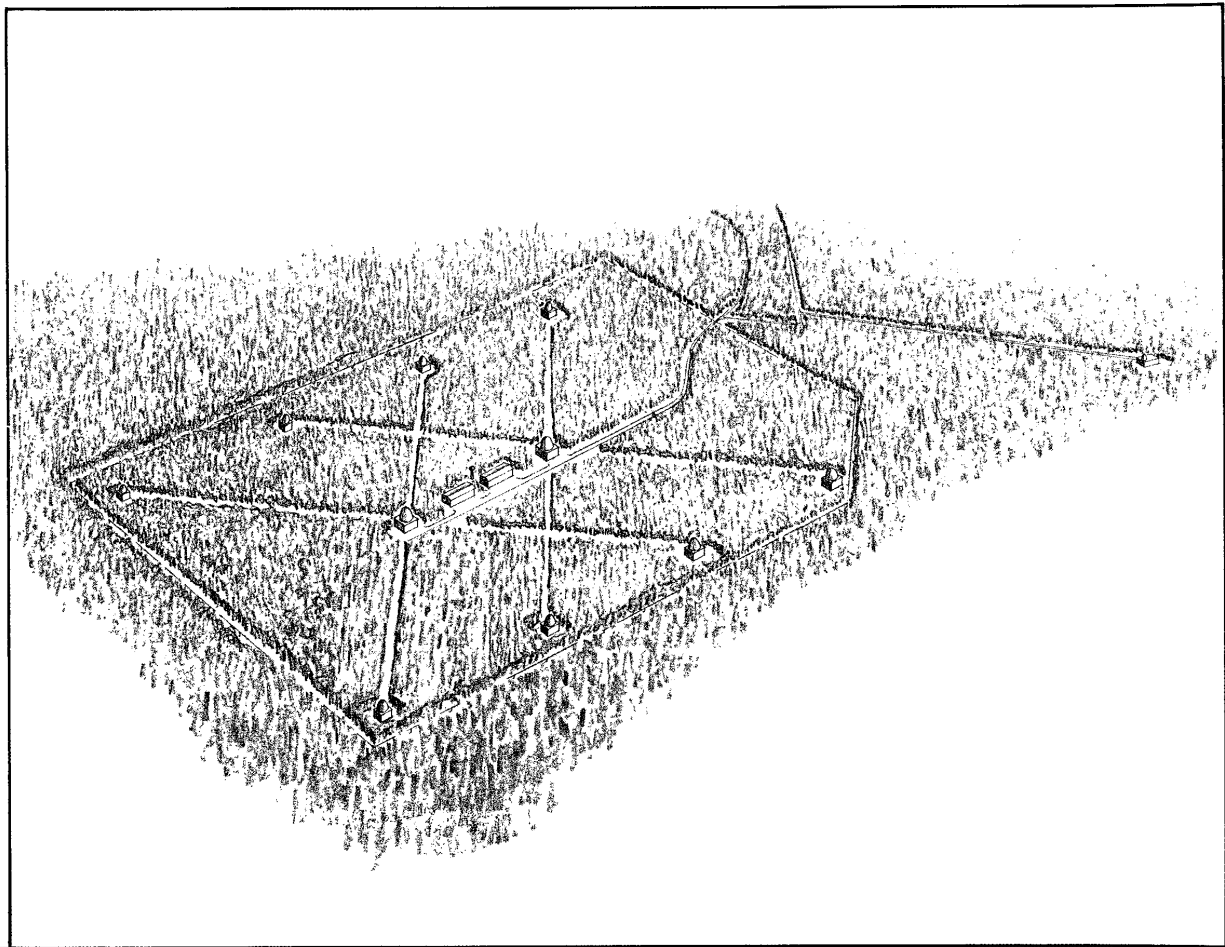

FIGURE 3. PERSPECTIVE VIEW OF KIRZHACH SITE A, WHEN COMPLETED.

TOP SECRET

TOP SECRET

25X1

25X1



TOP SECRET



FIGURE 4. KIRZHACH INTERFEROMETER INSTALLATION, SITES A AND B.

TOP SECRET

TOP SECRET

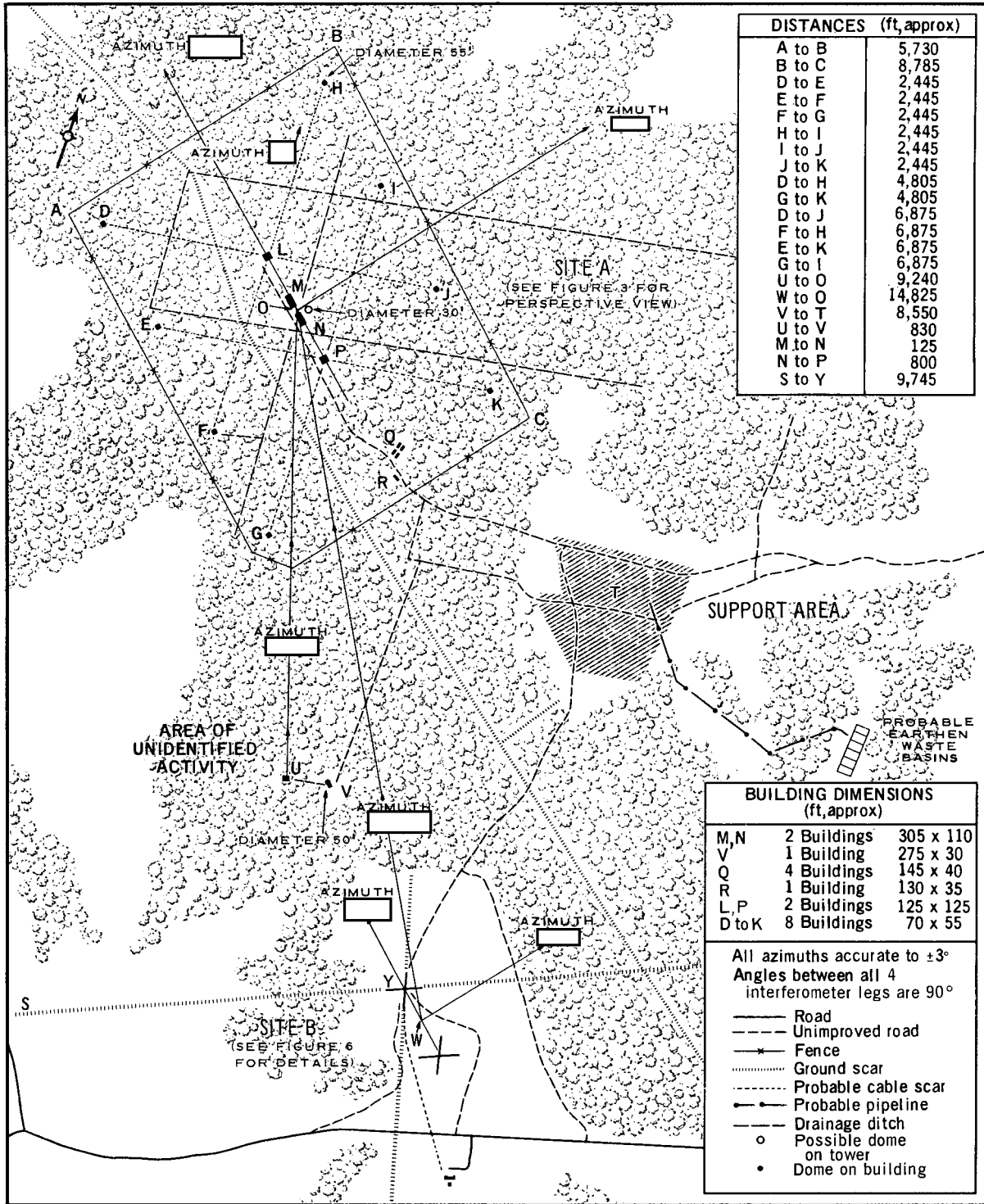
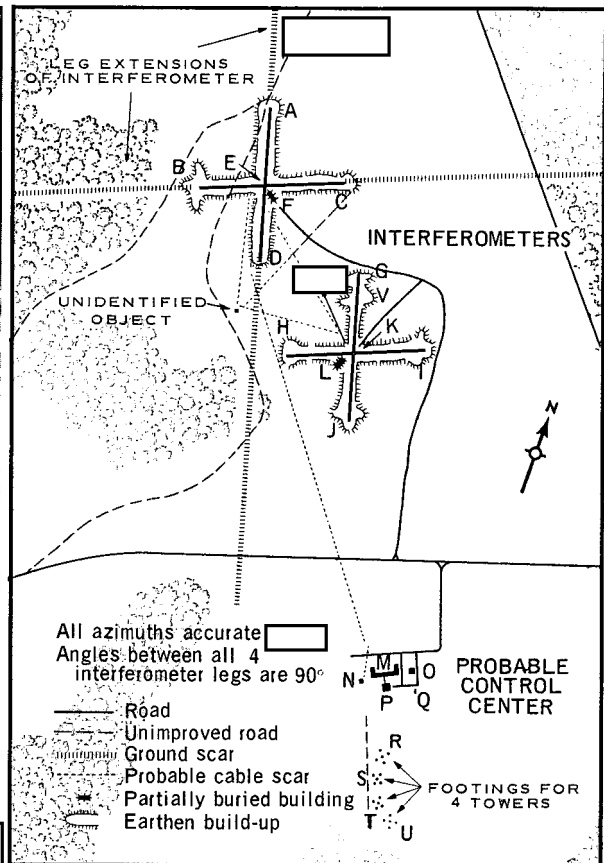
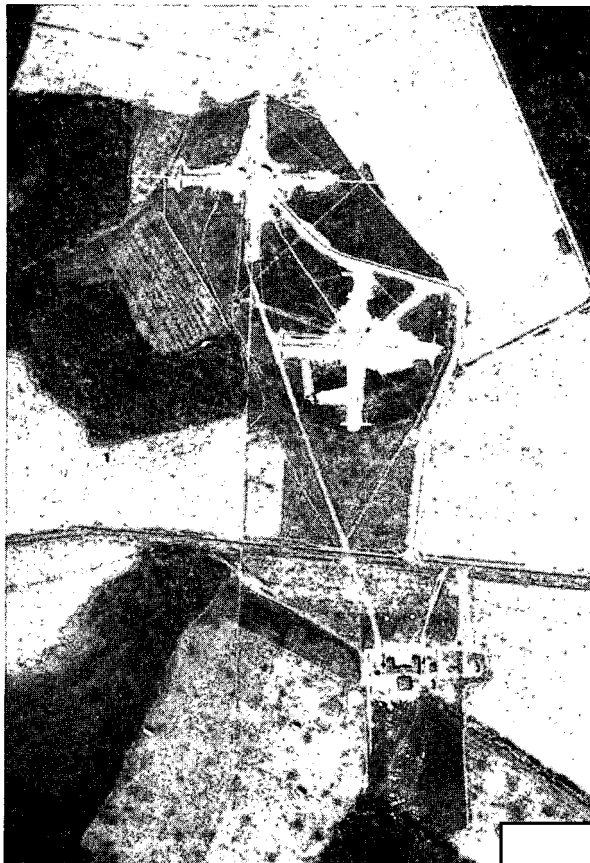

FIGURE 5. LAYOUT OF KIRZHACH INSTALLATION, SITES A AND B.

TOP SECRET



25X1D

25X1D

25X1D

25X1D

DISTANCES (ft, approx)				BUILDING DIMENSIONS (ft, approx)					
A to D	1,160	M to K	2,445	S to T	185	M	240 x 45	O	60 x 30
B to C	1,160	E to K	1,545	T to U	185	P, L	70 x 45	N	30 x 25
G to J	1,160	M to E	3,920	G to V	175		90 x 90	Q	30 x 15
H to I	1,160	R to S	185				70 x 50		

FIGURE 6. SITE B, KIRZHACH.

25X

its support area, this is the smallest of the Moscow-area sites although its interferometer is of standard size.

In addition to the 1 plus-configured interferometer with leg lengths of 1,000 feet, the site contains 1 control/equipment building buried at the leg bisection point, a probable tower-mounted storage tank, 7 or 8 support buildings, a group of earthen basins, and several small unidentified objects. The site is secured and road served.

Based on interpretation of photography from [redacted] there ap-

pears to be a regular pattern of ground scars or marks along each leg. These scars or marks, 4 on each half leg, are considered to be possible antenna positions, but the small scale of the available photography precludes detailed measurement of their spacing.

#### MOSCOW/SUPONINO AIRFIELD INTERFEROMETER SITE

This site, 13 nm east-northeast of the Kremlin, is 1 of the most unusual Soviet interferometer installations--not from the standpoint of the interferometer configuration,

25X1D

25X



25X10



which is similar to that of many others in the USSR, but because of the associated buildings and equipment (Figures 8 and 9), much of which is felt to be electronic or at least electronics associated. This circumstance, when taken together with the presence of the aircraft, the airfield, and the interferometer, makes it seem most likely that this facility is engaged in research and development work such as airborne instruments electronics testing, rather than in the strictly tracking activity that is suspected at most Soviet interferometer sites.

The original, prepared-surface portion of

the interferometer measured 670 by 670 feet, but present ground scarring indicates that the legs are being extended to conform more closely with the normal Soviet size of about 1,000 feet per leg, overall.

Just east of the interferometer are 3 unidentified structures arranged to form an equilateral triangle with an unidentified object at the center. South and southeast of this grouping are 3 towers and 2 unidentified objects situated on hardstands or cleared areas. All of these unidentified objects and towers are believed to contain or support electronic equip-

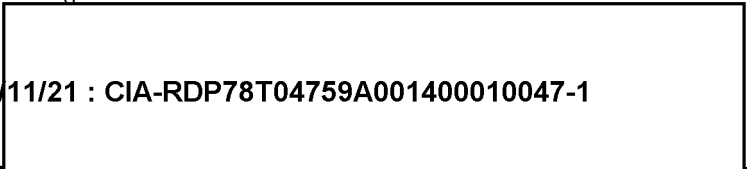

25X

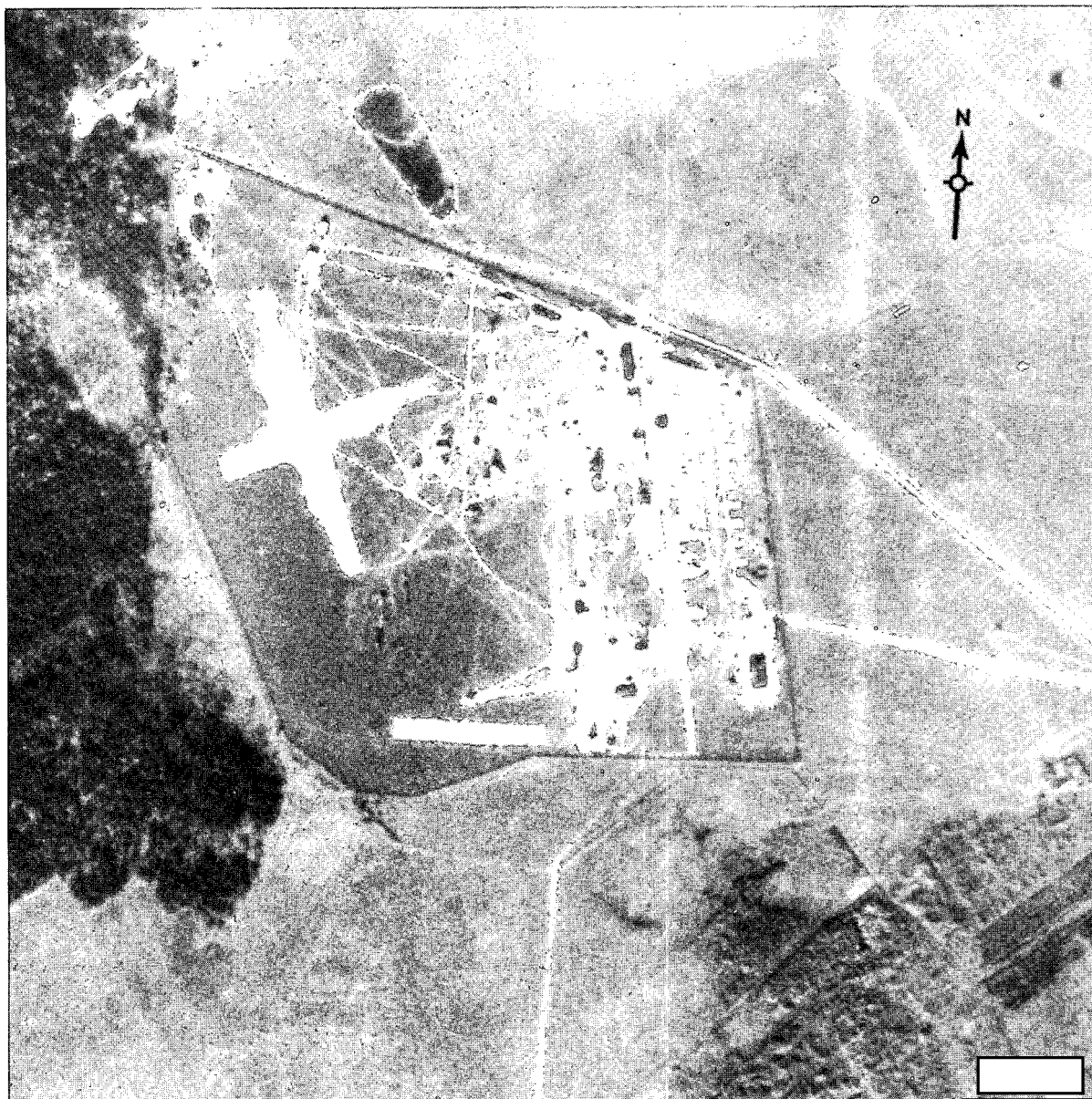

25X1D

FIGURE 8. MOSCOW/SUPONINO AIRFIELD INTERFEROMETER SITE.

25X

ment. Along the southern fenceline is a cleared rectangular area that may contain an antenna array.

Along the eastern fenceline are 3 large, 3 medium, and 14 small aircraft hardstands. The 3 large hardstands are occupied by twin-engine straight-wing aircraft (probably BEAGLE).

One of the medium-sized hardstands is occupied by a probable swept-wing fighter-type aircraft. The remaining hardstands contain an undetermined number of small aircraft. An aircraft taxiway that enters the site from the east leads from the southern portion of the Moscow/Suponino Airfield [redacted] which has a 3,700-

25X1A

25X

TOP SECRET

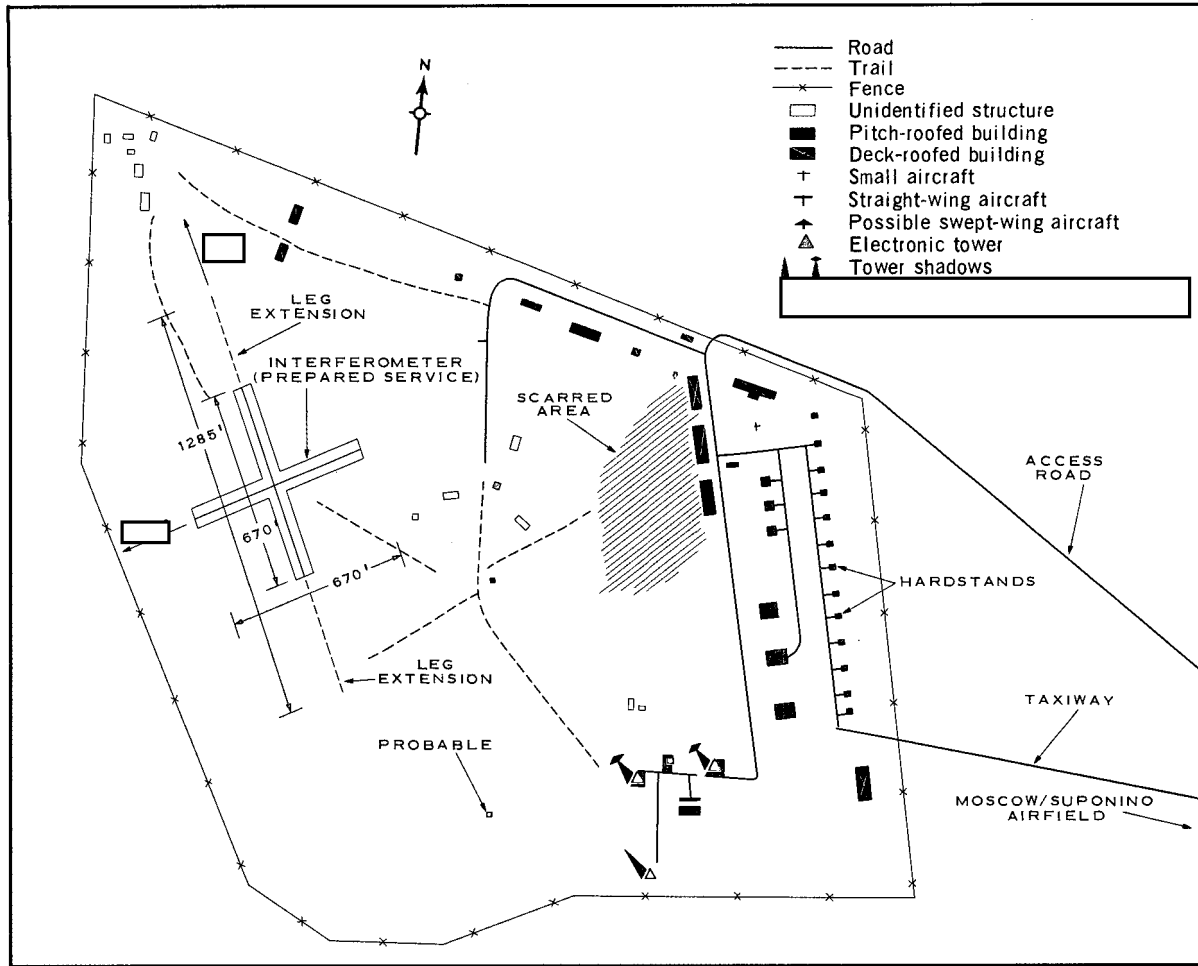

PITCHED-ROOF BUILDINGS

2 Buildings	200 x 40
3 Buildings	125 x 40
1 Building	70 x 25
1 Building	55 x 55
1 Building	45 x 30
1 Building	20 x 15

DECK-ROOFED BUILDINGS

1 Building	125 x 40
1 Building	120 x 45

FIGURE 9. LAYOUT OF MOSCOW/SUPONINO AIRFIELD INTERFEROMETER SITE.

by 200-foot northwest-southeast sod runway.

**TALSI TWIN INTERFEROMETER SITE**

The Talsi site (Figure 10) has been included in this report because it is the only other known Soviet facility equating to Kirzhach Site B. At

both sites, 2 interferometers have been placed the same distance apart--1,545 feet, center to center--and 1 interferometer at each site has had its base lines extended outward in each direction from the center. As at Site B, there are at Talsi clear indications of this extension

TOP SECRET

TOP SECRET

25X

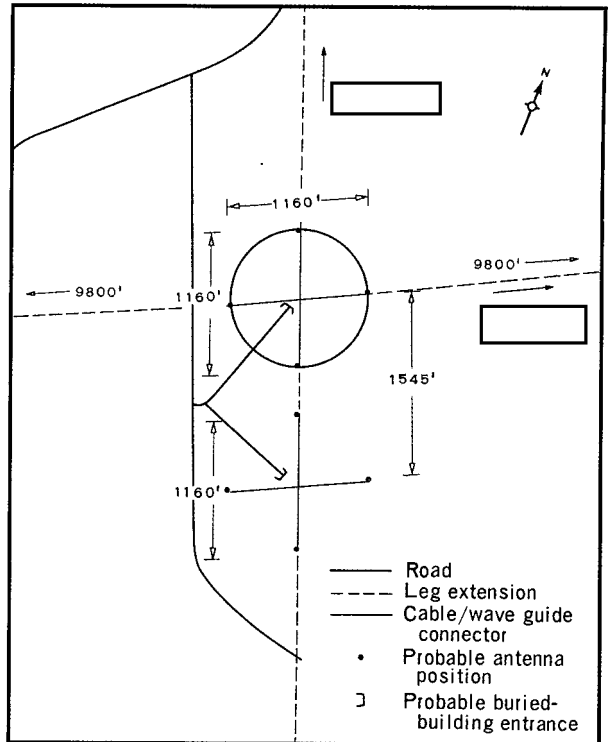

25X1D

25X1D

25X1D

FIGURE 10. TALSII TWIN INTERFEROMETER SITE.

25X1B

25X

TOP SECRET

25X

25X

TOP SECRET

Table 1. Comparative Data on Selected Interferometer Sites

Site	Coordinates	Type*	Base Legs*		Positions*			
			Length (feet)	Number per Half Leg	Separation Distance A-B B-C C-D D-E			
Kirzhach A	56-05-05N 38-29-25E	Overlapping	6,875	1	(See Figure 5)			
Kirzhach B	56-04-00N 38-30-25E	Twin	1,160	Under construction	(See Figure 6)			
Bronnitsy	55-23-40N 38-20-20E	+	1,000	4 (poss)	(See Figure 7)			
Moscow/Supo- nino A/F	55-52-05N 37-57-00E	+	U/C	Unknown	(See Figure 9)			
Talsi	57-17-00N 22-35-40E	Twin	1,160	Unknown	(See Figure 10)			
SSATC 1	45-52-50N 73-37-50E	⊙	400**	Unknown	(See Figure 14)			
SSATC Sup- port Base	46-00-00N 73-42-00E	+	910/1,040	Unknown	--			
SSATC 3	45-36-40N 72-36-20E	⊕	1,000	Unknown	--			
SSATC 4	45-57-00N 72-13-20E	⊕	1,000	4 (suspect)	--			
SSATC 5	45-53-40N 71-20-20E	⊕	1,000	4 (suspect)	--			
SSATC 6	46-14-00N 70-54-30E	⊕	1,000	4	[ ] 220 '220 (See Figure 17)			
SSATC 7	46-37-00N 70-46-00E	⊕	1,000	4 (suspect)	--			
SSATC 8	46-55-40N 70-49-30E	⊕	[ ]	4	[ ] (See Figure 16)			
SSATC 9	46-52-40N 71-52-20E	⊕	1,000	4 (suspect)	--			
SSATC 11	46-40-50N 72-37-40E	⊕	1,000	4 (suspect)	--			
SSATC 12	42-24-20N 72-34-00E	⊕	1,030	4 (suspect)	--			
SSATC 14	47-07-05N 69-10-00E	⊕	1,000	4	25 55 210 210			
SSATC 15	47-22-00N 67-25-00E	⊕	1,000	Unknown	(See Figure 15)			
Kozelsk A	53-53-50N 35-46-00E	⊗	[ ]	4 (max)	180	[ ]	170	170
Kozelsk B	53-48-10N 35-47-10E	⊗	[ ]	4 (max)	180	[ ]	170	170
Kozelsk D	53-53-40N 35-52-20E	⊗	[ ]	4 (max)	180	[ ]	170	170
Kozelsk E	53-51-25N 35-41-15E	×	[ ]	Probably same as Kozelsk F				
Kozelsk F	53-41-03N 35-39-05E	×	[ ]	(See Figure 18)				
Tyumen A	56-41-50N 65-35-20E	⊗	[ ]	Undetermined				
Tyumen C	56-51-00N 65-28-05E	⊗	[ ]	Undetermined				
Plesetsk D	62-53-30N 40-47-35E	⊗	[ ]	Undetermined				
Plesetsk G	62-51-15N 40-34-40E	⊗	[ ]	Undetermined				
Omsk A	55-07-35N 73-37-40E	×	[ ]	Probably same as Kozelsk F				

\*See Figure 11.

\*\*As reported in earlier publication and based on [ ] photography. 3/

in each of the 4 directions, but the exact terminus cannot be defined in all cases. However, the visible cable scarring leads to the conclusion that the extended interferometer at Talsi will have base legs about 19,600 feet in length (2 times 9,800 feet), which almost exactly equates to the estimated overall length of the Site B extensions (19,500 feet). Also, not only does the size compare favorably, but the apparent type of interferometer at the 2 sites seems the same.

The major differences between the 2 sites are 1) the alignment of the 2 configurations with

respect to each other: at Talsi, the 2 configurations are inline whereas at Kirzhach Site B the 2 are offset from each other; 2) at Talsi, a ring road is present around 1 of the interferometers;\* 3) the leg orientations are not the same at the 2 sites (see Table 1).

COMPARISON OF INTERFEROMETER TYPES

The final section of this report consists of tabular and graphical material illustrating and

\*On more recent photographic coverage of the area, that of [ ] a ring road was also revealed around the southern plus configuration.

TOP SECRET



25X1

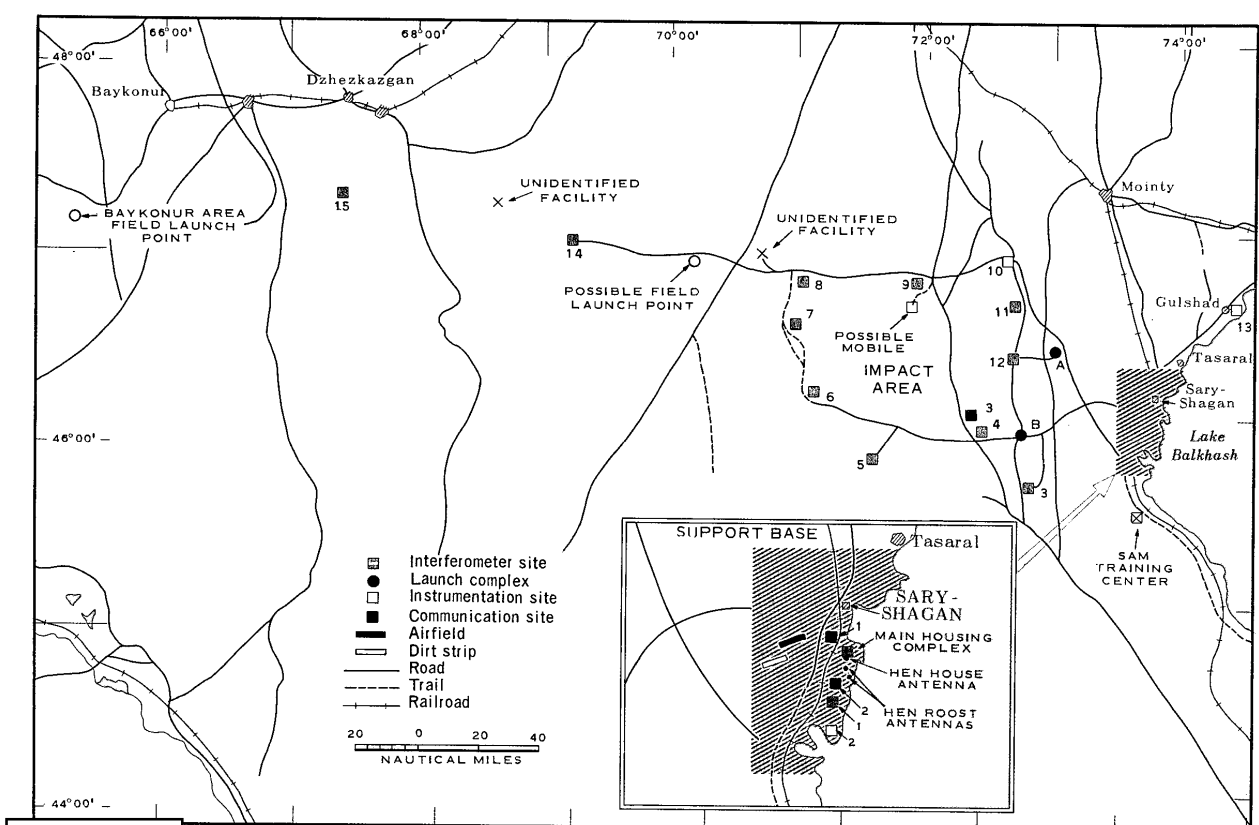

FIGURE 12. LOCATION OF INTERFEROMETER SITES, SSATC.

TOP SECRET

TOP SECRET

TOP SECRET

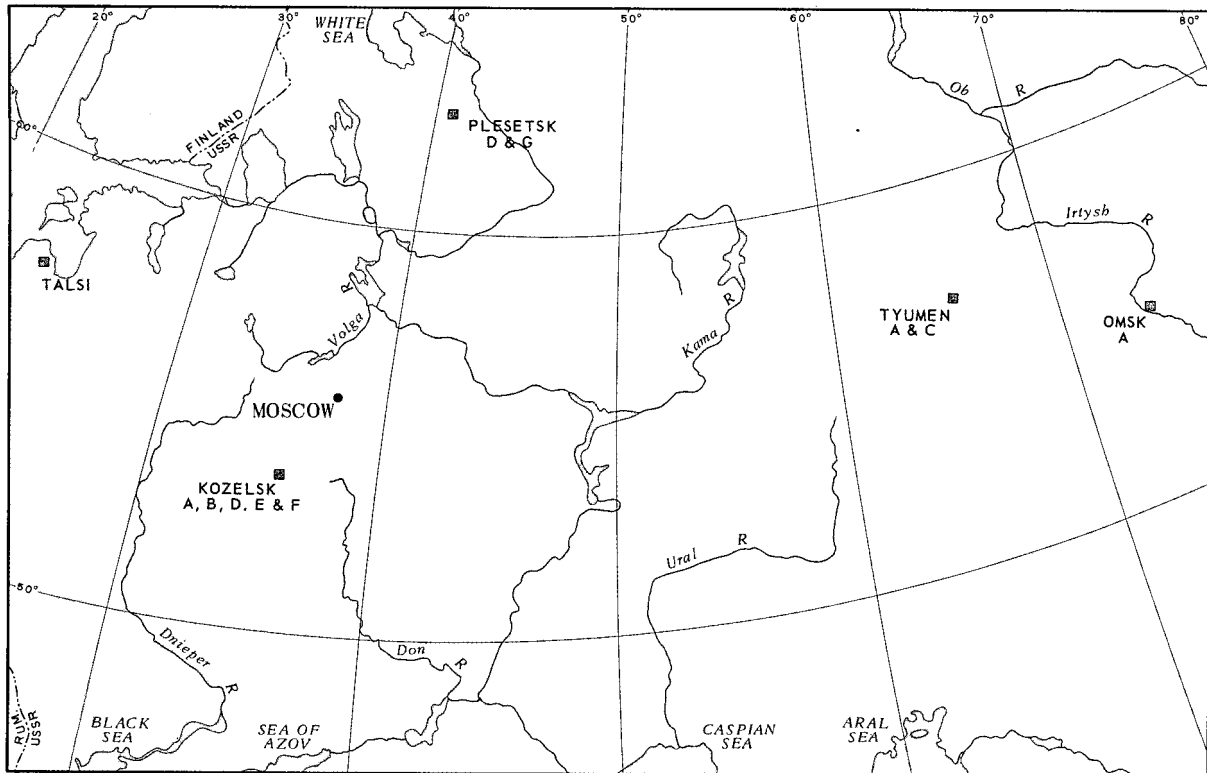

FIGURE 13. LOCATION OF SELECTED OTHER INTERFEROMETER SITES.

comparing the various types of interferometers. Table 1 gives overall leg length and orientation together with the number and distance apart of positions per half leg. A descriptive key to the different types of interferometers and to the standard terminology used throughout this report has also been prepared (Figure 11), as well as maps locating the various sites (Figures 1, 12, and 13). Finally, Figures 14 through 19 illustrate examples of the various types.

Comparison of the information collected in Table 1 shows that SSATC Sites 5-9, 11, 14, and 15 2/ are all oriented at precisely the same azimuths, and that these sites make up the entire northwestern interferometer network

lying beyond Sites 4 and 12 (which are also oriented alike). This would suggest that Sites 5-9, 11, 14, and 15 were laid out to operate in conjunction with one another, and that Sites 4 and 12 also probably operate in conjunction with each other.

In regard to the ICBM-related interferometers, it is interesting to note that except for the 2 interferometers at the Plesetsk Complex, all base legs at ICBM complexes are longer than at the majority of other interferometers in the USSR. In addition, within any given ICBM complex, all interferometers are oriented at the same azimuths (within the  estimated accuracy of mensuration).

TOP SECRET

TOP SECRET

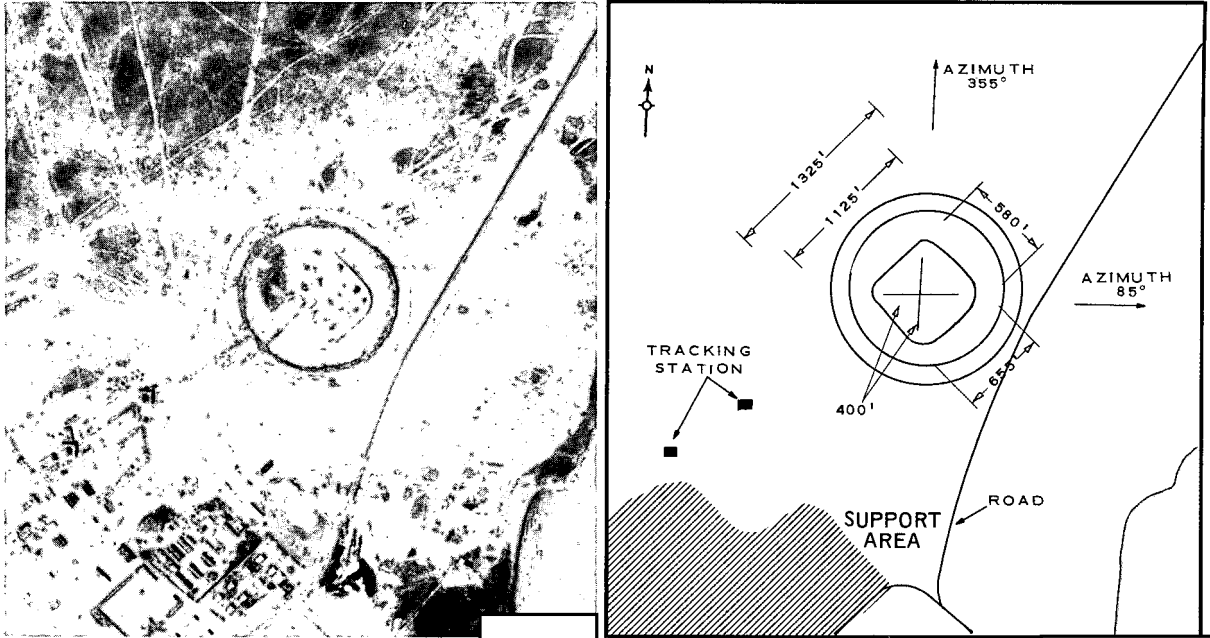

FIGURE 14. TYPE I INTERFEROMETER (SSATC INSTRUMENTATION SITE 1).

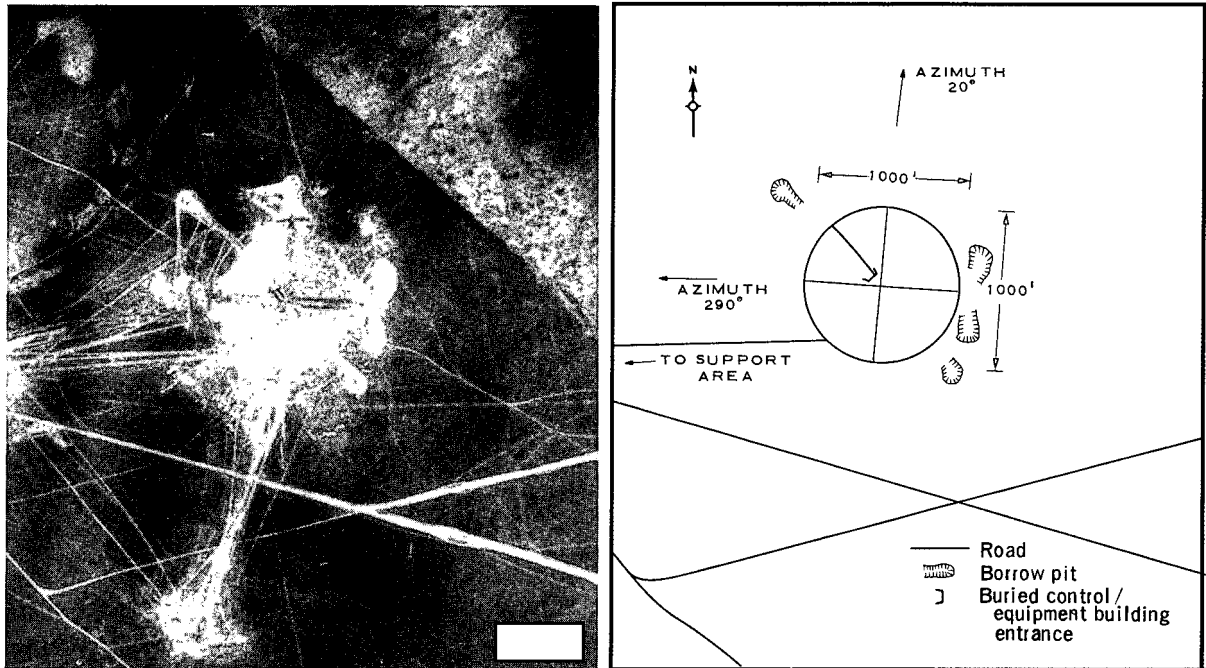

FIGURE 15. TYPE III INTERFEROMETER (SSATC INSTRUMENTATION SITE 15).

TOP SECRET

TOP SECRET

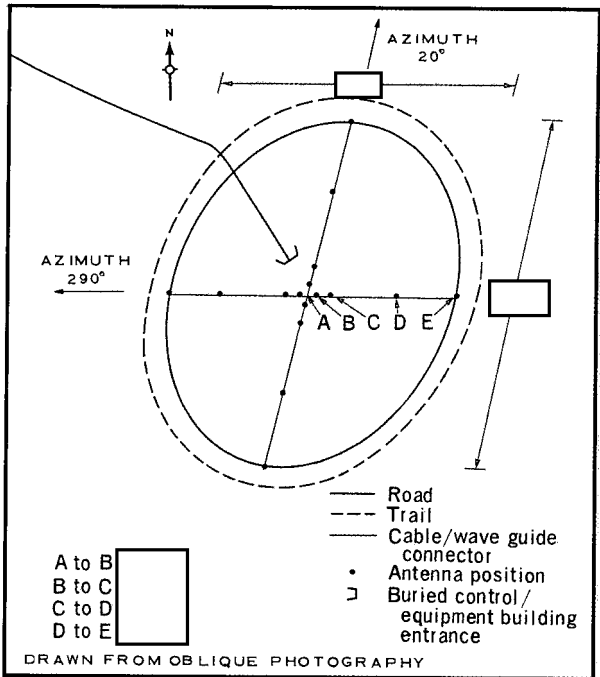

FIGURE 16. TYPE IV INTERFEROMETER (SSATC INSTRUMENTATION SITE 8).

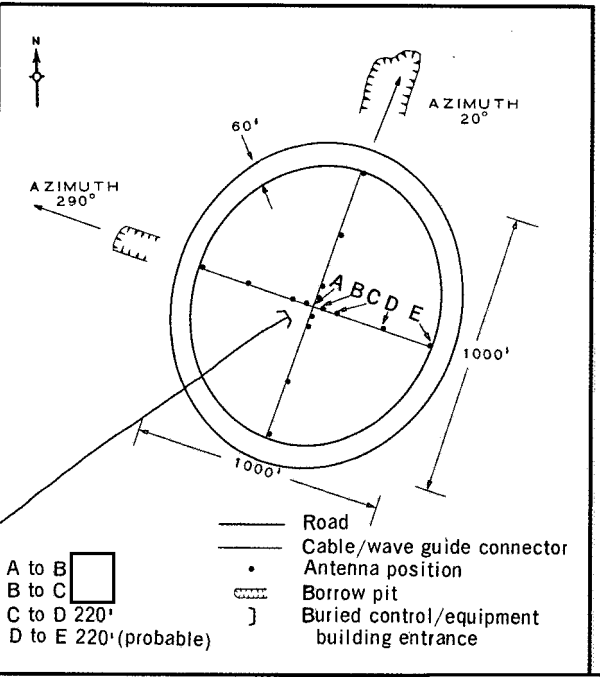
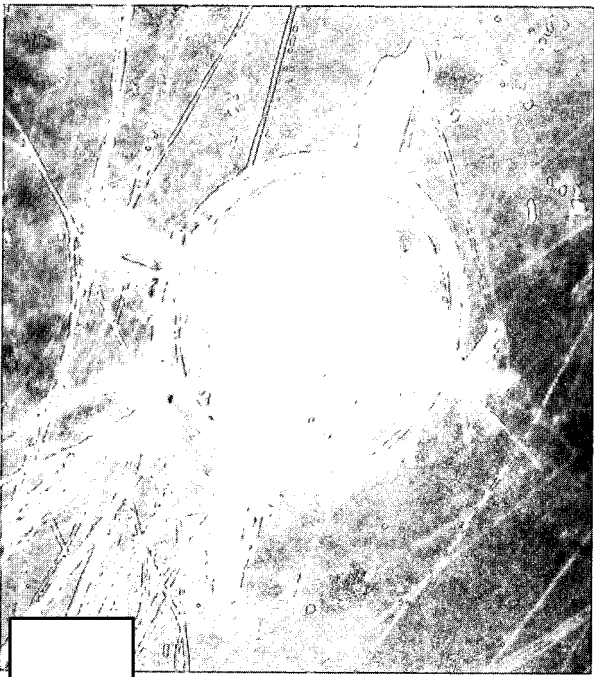

FIGURE 17. TYPE V INTERFEROMETER (SSATC INSTRUMENTATION SITE 6).

TOP SECRET

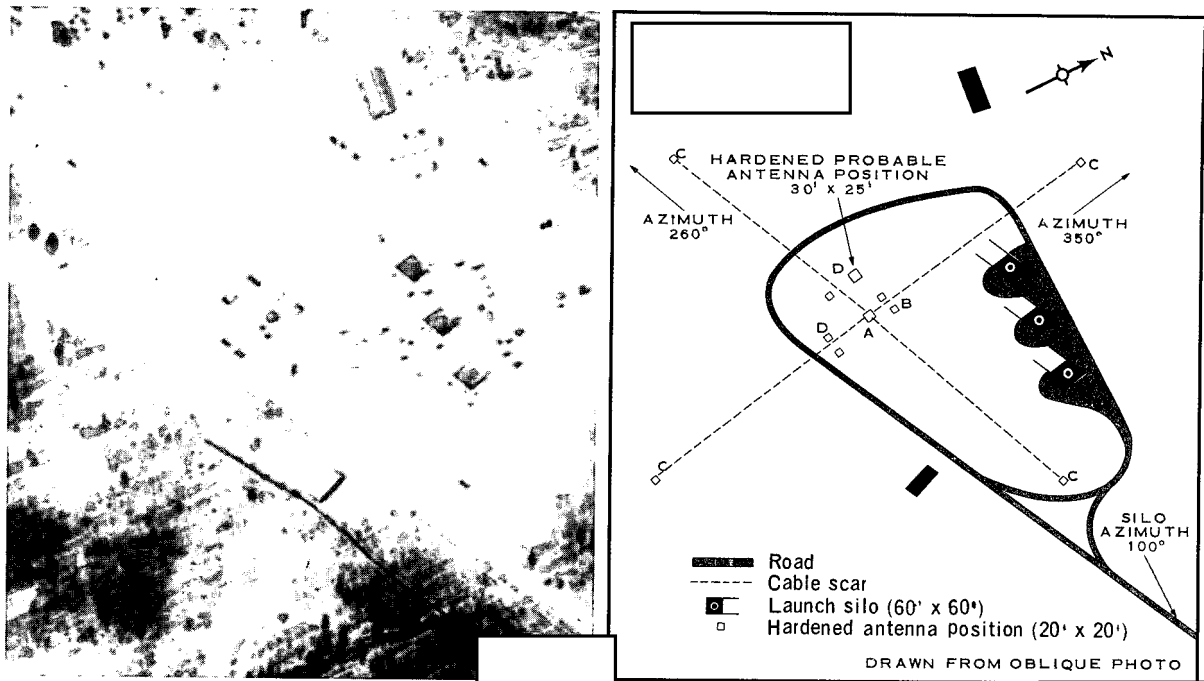

FIGURE 18. TYPE VI INTERFEROMETER (KOZELSK ICBM COMPLEX LAUNCH AREA F).

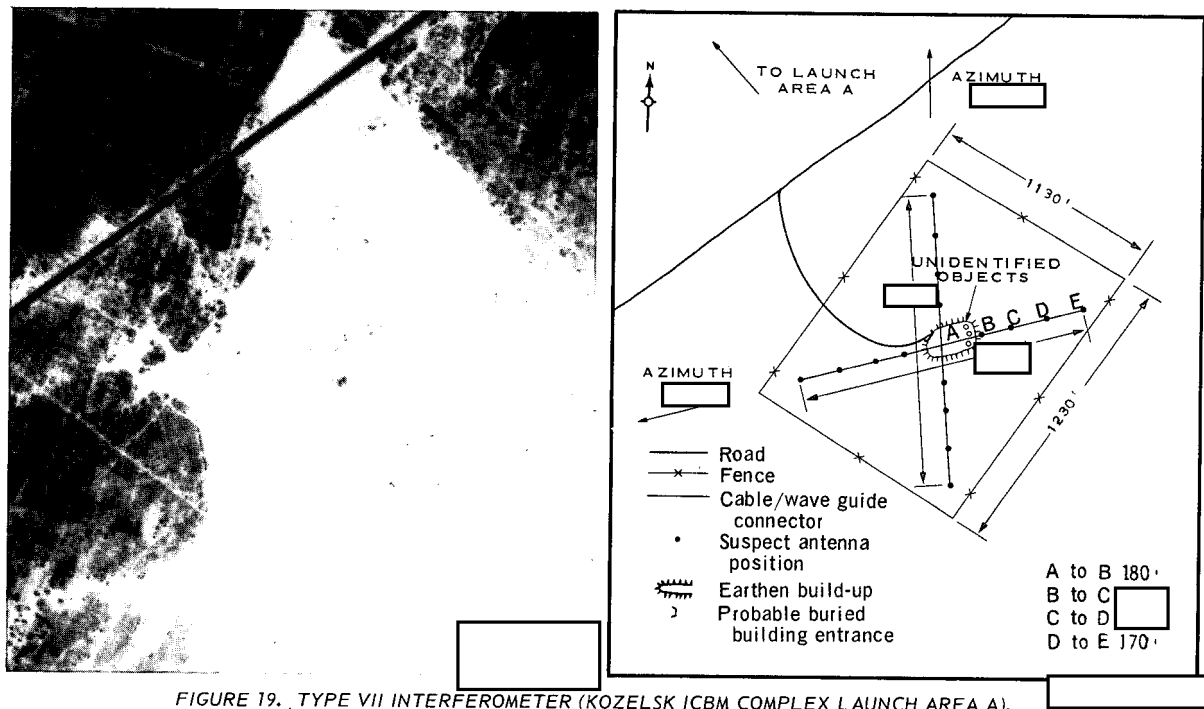

FIGURE 19. TYPE VII INTERFEROMETER (KOZELSK ICBM COMPLEX LAUNCH AREA A).

25X1D

Approved For Release 2003/11/21 : CIA-RDP78T04759A001400010047-1

Next 1 Page(s) In Document Exempt

Approved For Release 2003/11/21 : CIA-RDP78T04759A001400010047-1



Approved For Release 2003/11/21 : CIA-RDP78T04759A001400010047-1

RECORD COPY	COPY NO.	PUB. DATE	LOCATION	MASTER	DATE RECEIVED	LOCATION											
DISPOSITION DATE (S)				STOCK LEVEL	MINIMUM 1	MAXIMUM 8											
CUT TO COPIES	0	DATE July 1971	CUT TO COPIES	DATE	COPIES DESTROYED												
CUT TO COPIES		DATE	CUT TO COPIES	DATE													
CUT TO COPIES		DATE	MASTER	DATE													
DATE			RECEIVED OR ISSUED			NUMBER OF COPIES			DATE			RECEIVED OR ISSUED			NUMBER OF COPIES		
MO.	DAY	YR.	REC'D	ISS'D	BAL	MO.	DAY	YR.	REC'D	ISS'D	BAL	MO.	DAY	YR.	REC'D	ISS'D	BAL
6	14	68			8						8						
5	22	69		1	7												
7	11	72															

Approved For Release 2003/11/21 : CIA-RDP78T04759A001400010047-1