

Approved For Release 2000/04/19 : CIA-RDP79B01737A001100010001-8

A

Approved For Release 2000/04/19 : CIA-RDP79B01737A001100010001-8

SECRET

CCI-2813

Approved For Release 2000/04/19 : CIA-RDP79B01737A001100010001-8

11 DEC 1954

MEMORANDUM FOR: Assistant Director for Operations
SUBJECT : Additional Briefing Material for
Clark Committee
REFERENCE : Memorandum from Assistant Director for
Operations, 26 November 1954, same subject

1. I am transmitting an original and three copies of additional information, as you requested, to supplement manuals submitted to the Clark Committee.
2. This information is attached as Tabs A, B, C and D, corresponding to the tab designations used in your memorandum.
3. Personnel figures were provided by the Office of Personnel. Budget figures have been checked with the Comptroller's Office.

/s/

HUNTINGTON D. SHELDON
Assistant Director
Current Intelligence

Enclosures
Tabs A, B, C, and D

Approved For Release 2000/04/19 : CIA-RDP79B01737A001100010001-8

8 December 1954

Encl 6; OOI-2813

OFFICE OF CURRENT INTELLIGENCE

AUTHORITY, MISSION, FUNCTIONS AND ORGANIZATION

AUTHORITY

1. The National Security Act of 1947, as amended:
 - a. Establishes CIA under the National Security Council (Section 102(a)).
 - b. Provides that intelligence affecting national security be made available to the Director of Central Intelligence for correlation, evaluation and dissemination (Section 102(e)).
 - c. Assigns the Director of Central Intelligence responsibility for protecting intelligence sources and methods.
2. The National Security Council:
 - a. Defines and categorizes current intelligence (NSCID #3).
 - b. Authorizes the several departments of government to produce and disseminate current intelligence necessary to meet their internal requirements or external responsibilities (NSCID #3).
 - c. Directs that critical information affecting the national security be immediately disseminated to all concerned (NSCID #1, par. 6).
 - d. Provides for protection of special intelligence sources, methods and activity (NSCID #9).
3. The Director of Central Intelligence:
 - a. Approved the mission, functions and organizational pattern of the Office of Current Intelligence in CIA Regulation 1-130.
 - b. Approved CIA Regulation 120 to protect special intelligence sources and methods in CIA.

MISSION

1. The Assistant Director for Current Intelligence is charged with producing and disseminating all-source current intelligence, with providing current intelligence support for the Central Intelligence Agency and other agencies as directed; with participation in the inter-agency development of special intelligence policy, and with control of special intelligence activities in CIA.

~~SECRET~~

FUNCTIONS

1. The Assistant Director for Current Intelligence shall:
 - a. Produce all-source current intelligence and provide internal and external current intelligence briefing and support as directed.
 - b. Maintain a 24-hour Central Intelligence Agency Watch to alert United States government officials upon receipt of critical information.
 - c. Produce indications intelligence in support of the Central Intelligence Agency member of the Intelligence Advisory Committee Watch Committee and provide administrative and substantive support for the National Indications Center, as directed.
 - d. Represent the Central Intelligence Agency in formulation of policies and procedures relating to procurement, utilization, exploitation, security and control of special intelligence.
 - e. Regulate the special intelligence activities and contacts of Central Intelligence Agency personnel at other agencies.
 - f. Direct the preparation, execution and administration of the Agency special intelligence program.
 - g. Perform special functions as specified by the Director of Central Intelligence.

ORGANIZATION

The organizational components of the Office of Current Intelligence and statement of their mission and functions are presented in the following pages of Tab A.

~~SECRET~~

SECRET

Approved For Release 2000/04/19 : CIA-RDP79B01737A001100010001-8
OFFICE OF CURRENT INTELLIGENCE

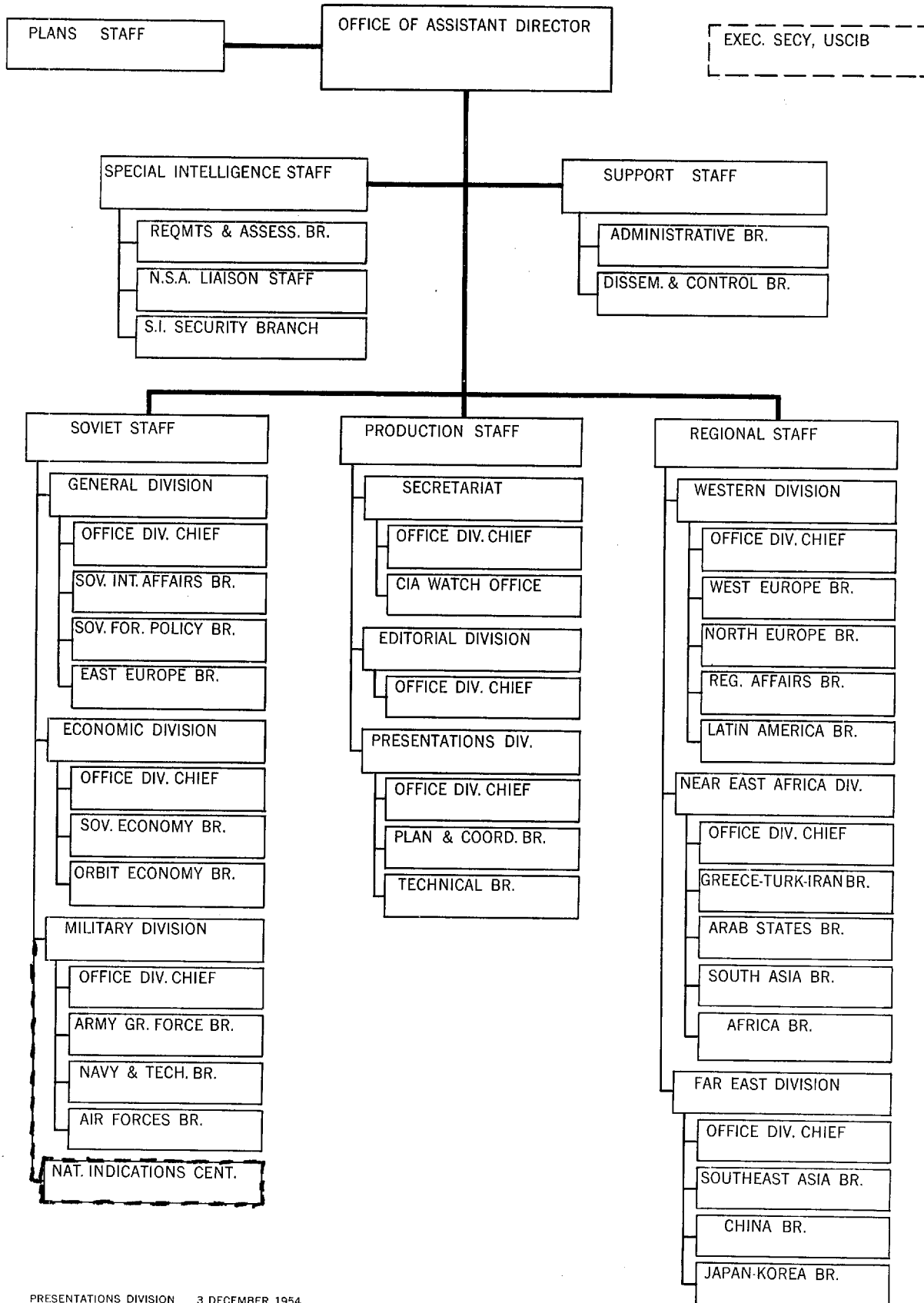

Approved For Release 2000/04/19 : CIA-RDP79B01737A001100010001-8
SECRET

SECRET

Approved For Release 2000/04/19 : CIA-RDP79B01737A001100010001-8

STATEMENT OF MISSION AND FUNCTIONS

OFFICE OF CURRENT INTELLIGENCE

SPECIAL INTELLIGENCE STAFF

I. MISSION

The Special Intelligence Staff will advise the Assistant Director Current Intelligence in the formulation of COMINT policies and the establishment of a COMINT program within CIA; will represent CIA on USCIB and NSA committees and in COMINT liaison activities concerned with policy making and security, will develop and administer CIA COMINT and OCI all-source requirements, assessments and liaison programs, and will administer CIA COMINT security and all OCI security programs.

II. FUNCTIONS

- a. Represents CIA on USCIB committees, NSA committees and panels and other interdepartmental committees concerned with formulating U.S. governmental COMINT policies, including the USCIB Executive Committee, Intelligence Committee and Security Committee.
- b. Provides a secretariat for CIA representation on USCIB and its committees, including the preparation of briefs and background material and maintenance of files and other documents affecting COMINT policy.
- c. Arranges for, and follows up, fulfillment within CIA of USCIB decisions.
- d. Recommends to the AD/CI the establishment within CIA of policies governing the collection, utilization, operational use, sanitization, disguise, dissemination and security of COMINT, and related matters.
- e. Develops, coordinates and administers a continuing CIA COMINT requirements program and establishes CIA COMINT priorities and spot requirements for appropriate USCIB and NSA action.
- f. Develops and administers an OCI all-source requirements program, including establishment of spot requirements and arrangements for collection, and represents OCI on inter- and intra-agency committees concerned with requirements, collection and source exploitation.
- g. Authenticates need for, and arranges, CIA liaison with NSA and other USCIB agencies, and OCI liaison with IAC and other agencies, provides administrative support for CIA representation at NSA and exercises COMINT policy supervision over CIA personnel at NSA.

Approved For Release 2000/04/19 : CIA-RDP79B01737A001100010001-8

SECRET

SECRET

Approved For Release 2000/04/19 : CIA-RDP79B01737A001100010001-8

Special Intelligence Staff (2)

- h. Evaluates and determines the degree of use of information received by OCI and maintains related records, and advises CIA components with respect to COMINT sources, methods, use and potential and OCI components on collateral source potential.
- i. Advises the Assistant Director in regard to the establishment and implementation of CIA COMINT security policies and procedures and in the development and administration of the OCI security program.
- j. Provides guidance on COMINT matters for overseas OCI personnel.
- k. Recommends policy governing CIA relations with foreign governments in the COMINT field, and controls all OCI liaison with other agencies.
- l. Arranges for fulfillment by CIA of NSA and other USCIB agency requirements, and by OCI of requirements levied on it by other CIA components and by other agencies.
- m. Serves, through the staff chief, as a member of the OCI Publications Board and of the OCI Career Service Board.

Approved For Release 2000/04/19 : CIA-RDP79B01737A001100010001-8

SECRET

SECRET

Approved For Release 2000/04/19 : CIA-RDP79B01737A001100010001-8

STATEMENT OF MISSION AND FUNCTIONS

OFFICE OF CURRENT INTELLIGENCE

SPECIAL INTELLIGENCE STAFF

REQUIREMENTS AND ASSESSMENTS BRANCH

I. MISSION

The Requirements and Assessments Branch will establish an all-source requirements and liaison program for OCI and a COMINT requirements and liaison program for CIA, and will provide guidance and advice with respect to the use and potential of sources of information.

II. FUNCTIONS

- a. Develops an all-source requirements program in direct support of OCI's mission and establishes media as necessary to ensure the most rapid and adequate receipt of information in response to OCI requirements.
- b. Establishes and coordinates OCI's spot collateral requirements and makes arrangements for initiating collection action.
- c. Represents OCI on intra- and inter-agency meetings concerned with requirements, priorities and the allocation of collection effort and facilities.
- d. Arranges for fulfillment of requests originated by OCI, Special Center and NSA components for maps, translations, documents and reference materials.
- e. Makes all administrative arrangements for the conduct of the weekly [REDACTED] teleconference and handles all requirements matters resulting therefrom.
- f. Develops, coordinates and establishes a continuing CIA COMINT requirements program for negotiation by the NSA Liaison Staff, establishes CIA's spot requirements and transmits them to the NSA Liaison Staff for action.
- g. Establishes CIA intelligence requirements and their priorities for inclusion in the USCIB Master Requirements List and information requirements for its Appendix.

25X1A

Approved For Release 2000/04/19 : CIA-RDP79B01737A001100010001-8

SECRET

SECRET

Approved For Release 2000/04/19 : CIA-RDP79B01737A001100010001-8
Requirements and
Assessments Branch (2)

- h. Provides essential support for NSA and USCIB Committees and alternate representation on the NSA Intercept Priorities Committee and Panels and the Processing Priorities Committee.
- i. Authenticates need for, and arranges, CIA operational liaison with NSA and USCIB agencies, through the NSA Liaison Staff or direct with the USCIB agency as appropriate, and with IAC and other agencies.
- j. Evaluates and determines the degree of use of information received by OCI provides advice on collateral source potential; maintains continuous records of COMINT received in CIA by volume, series, nationality, and other categories; provides technical guidance and advice with respect to COMINT sources, methods, use and potential.
- k. Arranges for the fulfillment by CIA offices of NSA and USCIB agency collection and production requirements.
- l. Arranges for the fulfillment of CIA requirements for intelligence support by OCI or USCIB agencies.
- m. Reviews all teletype communications to NSA and USCIB agencies for substantive content, format and clerical accuracy, and releases such messages for transmission.

Approved For Release 2000/04/19 : CIA-RDP79B01737A001100010001-8

SECRET

SECRET

Approved For Release 2000/04/19 : CIA-RDP79B01737A001100010001-8

STATEMENT OF MISSION AND FUNCTIONS

OFFICE OF CURRENT INTELLIGENCE

SPECIAL INTELLIGENCE STAFF

NSA LIAISON STAFF

I. MISSION

The NSA Liaison Staff will represent CIA at NSA; will exercise COMINT policy direction over CIA personnel at NSA; will implement the CIA requirements, assessments and liaison program at NSA; and will advise OCI concerning significant developments at NSA.

II. FUNCTIONS

- a. Represents CIA in policy matters with NSA and USCIB components at NSA.
- b. Represents CIA on the NSA General Priorities Committee, Intercept Priorities Committee and Processing Priorities Committee and other committees and panels related to COMINT policy, priorities and COMINT collection and exploitation, and prepares reports on meetings of these committees.
- c. Negotiates CIA requirements and their priorities in the committees above, makes arrangements with NSA for collection action on spot requirements, and continuously assesses and prepares reports on NSA's collection capabilities.
- d. Receives, approves and forwards to the R&A Branch, NSA requirements for CIA collection and the requirements of USCIB agencies at NSA.
- e. Obtains or prepares reports concerning COMINT sources, methods and technical COMINT matters.
- f. Reviews, approves or recommends action on proposed liaison between CIA and NSA and USCIB components at NSA.
- g. Through liaison with USCIB components located at NSA, coordinates intelligence activities between CIA and these components.

Approved For Release 2000/04/19 : CIA-RDP79B01737A001100010001-8

SECRET

SECRET

Approved For Release 2000/04/19 : CIA-RDP79B01737A001100010001-8
NSA Liaison Staff (2)

- h. Coordinates and reviews in the light of established COMINT policy, the liaison activities of CIA personnel represented at NSA and conduct necessary administrative services for these personnel.
- i. Prepares reports containing basic data with respect to NSA's organization and operations and other developments at NSA of interest to CIA, and to OCI in particular.

Approved For Release 2000/04/19 : CIA-RDP79B01737A001100010001-8

SECRET

SECRET

Approved For Release 2000/04/19 : CIA-RDP79B01737A001100010001-8

STATEMENT OF MISSION AND FUNCTIONS

OFFICE OF CURRENT INTELLIGENCE

SPECIAL INTELLIGENCE STAFF

SPECIAL INTELLIGENCE SECURITY BRANCH

I. MISSION

The Special Intelligence Security Branch is charged with the preparation and execution of the Agency's COMINT security program, and with the performance of COMINT security inspection functions.

II. FUNCTIONS

- a. Recommends the establishment of Agency policies relating to COMINT security, and establishes procedures for their implementation.
- b. Establishes safeguards necessary to prevent penetration of agency COMINT activities by unauthorized individuals; and issues necessary directives covering the security aspects of the exploitation, utilization and handling of COMINT.
- c. Obtains, through the CIA Security Office and other CIA sources, pertinent information regarding CIA and other personnel nominated for CIA Special Intelligence clearance. Approves or disapproves from a security standpoint (including need-to-know) the utilization of all personnel by the Agency on COMINT matters; briefs all such personnel upon clearance, rebriefs as necessary, and debriefs upon cancellation of clearance.
- d. Determines the effectiveness with which Agency COMINT security programs and policies are being accomplished.
- e. Engages in policy and program planning of COMINT emergency measures.
- f. Prescribes COMINT security policies relating to liaison and contact relations of cleared Agency employees with others; and conducts COMINT security liaison on behalf of CIA with the USCIB agencies.
- g. Investigates reports of violation or non-compliance with COMINT security policies or regulations and recommends or initiates appropriate action as may be required.

Approved For Release 2000/04/19 : CIA-RDP79B01737A001100010001-8

SECRET

SECRET

Approved For Release 2000/04/19 : CIA-RDP79B01737A001100010001-8
Special Intelligence
Security Branch (2)

- h. Makes necessary inspections, investigations and reports to assure proper maintenance of COMINT security.
- i. Arranges for the assignment and training of COMINT security officers as required throughout CIA.
- j. Administers and reviews the OCI-wide security program, including physical security, personnel security and document security, in accordance with CIA Regulations and in coordination with the Agency Security Office.

Approved For Release 2000/04/19 : CIA-RDP79B01737A001100010001-8

SECRET

SECRET

Approved For Release 2000/04/19 : CIA-RDP79B01737A001100010001-8

STATEMENT OF MISSION AND FUNCTIONS

OFFICE OF CURRENT INTELLIGENCE

SUPPORT STAFF

I. MISSION

The Support Staff will conduct central administrative, management, document control, and related support activities and will provide administrative support for other Special Center components.

II. FUNCTIONS

- a. Advises the AD/CI in matters relating to personnel and budgetary administration, training, administrative services, procurement and supply and other administrative activities.
- b. Guides and assists OCI staffs and divisions in, and conducts, personnel management, administrative services, budgetary, training and other administrative activities.
- c. Administers OCI records management, emergency, vital documents, safety, personnel evaluation and internal administrative publications programs.
- d. Disseminates, distributes, delivers and provides central accounting for OCI all-source material and all CIA COMINT material, and operates electrical communications with other agencies and components.
- e. Advises and assists OCI components in the establishment, operations and maintenance of document control and distribution activities.
- f. Provides administrative support for the OCI Career Service Board and for Special Center components of other Offices.
- g. Serves, through the Staff Chief, as a member of the OCI Career Service Board.

Approved For Release 2000/04/19 : CIA-RDP79B01737A001100010001-8

SECRET

SECRET

Approved For Release 2000/04/19 : CIA-RDP79B01737A001100010001-8

STATEMENT OF MISSION AND FUNCTIONS

OFFICE OF CURRENT INTELLIGENCE

SUPPORT STAFF

ADMINISTRATIVE BRANCH

I. MISSION

The Administrative Branch will conduct administrative activities in support of all Office of Current Intelligence components, and will provide administrative services activities for other components within the Special Center.

II. FUNCTIONS

- a. Advises the Assistant Director, Current Intelligence, in matters relating to personnel administration, budgetary administration, domestic and overseas travel, training, administrative services, procurement and supply, and other aspects of internal administration.
- b. Coordinates with primary CIA administrative offices on questions of policy and procedures where necessary.
- c. Provides guidance and assistance to OCI staffs and divisions in relation to personnel, administrative services, budget, domestic and overseas travel, training, and other administrative matters.
- d. Conducts central personnel management activities for OCI, including handling of promotions, recruitment, transfers, separations, and other personnel transactions.
- e. Maintains central personnel records.
- f. Conducts central administrative services activities, including space procurement, office equipment procurement, building maintenance, domestic and overseas travel arrangement, building evacuation planning, materials requisition and purchase and similar activities, and maintains related records.
- g. Prepares, revises, and maintains annual budget estimates and maintains records of allotments, expenditures and obligations, and prepares periodic status reports.

Approved For Release 2000/04/19 : CIA-RDP79B01737A001100010001-8

SECRET

SECRET

Approved For Release 2000/04/19 : CIA-RDP79B01737A001100010001-8

Administrative Branch

- h. Obtains information regarding OCI training needs and available CIA training courses and programs, and arranges for training of OCI personnel, in coordination with the OCI Training Officer and the Office of Training.
- i. Administers the OCI records management and vital documents program.
- j. Administers the OCI internal administrative publications program.
- k. Acts as secretary to, and provides stenographic and secretarial services for the OCI Career Service Board.
- l. Administers the OCI personnel evaluation program and maintains related records.
- m. Provides administrative services support for Logistics, OSG, USCIB Secretariat, Management Staff and other beach heads in the Special Center.

Approved For Release 2000/04/19 : CIA-RDP79B01737A001100010001-8

SECRET

SECRET

Approved For Release 2000/04/19 : CIA-RDP79B01737A001100010001-8

STATEMENT OF MISSION AND FUNCTIONS

OFFICE OF CURRENT INTELLIGENCE

SUPPORT STAFF

DISSEMINATION AND CONTROL BRANCH

I. MISSION

The Dissemination and Control Branch will, in support of OCI's current intelligence mission and CIA's COMINT mission, provide facilities for: document registration, dissemination, control and distribution internally and externally of all-source material for OCI and of COMINT for CIA, and will operate electrical communications facilities for the receipt and transmission of COMINT messages between departmental headquarters and other domestic and foreign points and for the receipt or transmission of all-source messages for OCI.

II. FUNCTIONS

- a. Disseminates COMINT internally and externally for all CIA components and all-source material for OCI, in accordance with requirements, policy and/or specific instructions.
- b. Guides and assists OCD in disseminating collateral material to OCI components and provides guidance, assistance and control to all CIA components in the dissemination of COMINT to foreign governments.
- c. Maintains master distribution lists for CIA COMINT publications and for OCI collateral publications.
- d. Maintains a central registry of incoming and outgoing all-source material for OCI and COMINT material for CIA, and operates a COMINT pouching facility.
- e. Operates internal and external all-source document distribution services for OCI and internal COMINT distribution services for other Special Center components.
- f. Operates a CIA COMINT external courier service to transport COMINT between CIA and other USCIB-approved COMINT areas in departmental headquarters.
- g. Operates secure electrical communications facilities to transmit COMINT messages within CIA and between CIA and other authorized recipients, and to transmit collateral messages between OCI and other CIA components.

Approved For Release 2000/04/19 : CIA-RDP79B01737A001100010001-8

SECRET

~~SECRET~~

Approved For Release 2000/04/19 : CIA-RDP79B01737A001100010001-8

STATEMENT OF MISSION AND FUNCTIONS

OFFICE OF CURRENT INTELLIGENCE

SOVIET STAFF

I. MISSION

The Soviet Staff will plan, coordinate and produce all-source current intelligence on the U.S.S.R., the Soviet Bloc, and the international organizations of Communism as instruments of Soviet policy; will prepare for the Assistant Director, Current Intelligence and the Director of Central Intelligence reports and briefs relating to indications of capabilities, vulnerabilities and intentions of the aforementioned governments; will provide briefing and other current intelligence support for other CIA components; and will provide CIA support for the National Indications Center and the IAC Watch Committee.

II. FUNCTIONS

With regard to the above:

- a. Serves, through the Staff Chief, as a permanent member of the Publications Board.
- b. Analyzes all-source current information, evaluates and comments upon material of current importance, and prepares items and articles for inclusion in regular and special OCI publications.
- c. On the basis of an indications checklist, selects critical or significant material and prepares summaries and reports indicating probable trends, developments, capabilities, vulnerabilities, and intentions.
- d. Prepares special reports, briefs and analyses of all-source current intelligence for Agency officials and other governmental officials, and provides continuing assistance for other CIA components.
- e. Executes projects in the reconstruction of critical events and developments for the purpose of testing hypotheses concerning Soviet and Satellite plans and actions and in the interest of more definitive conclusions concerning current trends, and prepares indications briefs and reports for the AD/CI and the DD/I.

Approved For Release 2000/04/19 : CIA-RDP79B01737A001100010001-8

~~SECRET~~

SECRET

Approved For Release 2000/04/19 : CIA-RDP79B01737A001100010001-8

Soviet Staff (Continued)

- f. In coordination with Presentations Division, prepares and presents current intelligence briefings for OCI, CIA and other governmental officials.
- g. Prepares reports and briefs of indications material for inclusion in the agenda of the IAC Watch Committee, and provides representation on, and coordinates CIA support for, the Indications Center of the IAC Watch Committee.
- h. Provides intelligence support, requirements and indications guidance for overseas OCI elements.
- i. Develops requirements for all-source current information and initiates requests for special materials and information.
- j. Conducts continuing desk-level liaison with CIA, IAC, and USCIB components in order to obtain data and, as appropriate, analyses on subjects of mutual concern and specialized interest.
- k. Conducts a continuing review and revision of hypotheses and conclusions relating to political, military and economic indications; and develops indicator checklists, indications guides, and procedures for analyzing all-source current information in terms of indications.
- l. Serves, through the Staff Chief, as a member of the OCI Career Service Board.

Approved For Release 2000/04/19 : CIA-RDP79B01737A001100010001-8

SECRET

SECRET

Approved For Release 2000/04/19 : CIA-RDP79B01737A001100010001-8

STATEMENT OF MISSION AND FUNCTIONS

OFFICE OF CURRENT INTELLIGENCE

SOVIET STAFF

I. MISSION

The Soviet Staff will plan, coordinate and produce all-source current intelligence on the U.S.S.R., the Soviet Bloc, and the international organizations of Communism as instruments of Soviet policy; will prepare for the Assistant Director, Current Intelligence and the Director of Central Intelligence reports and briefs relating to indications of capabilities, vulnerabilities and intentions of the aforementioned governments; will provide briefing and other current intelligence support for other CIA components; and will provide CIA support for the National Indications Center and the IAC Watch Committee.

II. FUNCTIONS

With regard to the above:

- a. Serves, through the Staff Chief, as a permanent member of the Publications Board.
- b. Analyzes all-source current information, evaluates and comments upon material of current importance, and prepares items and articles for inclusion in regular and special OCI publications.
- c. On the basis of an indications checklist, selects critical or significant material and prepares summaries and reports indicating probable trends, developments, capabilities, vulnerabilities, and intentions.
- d. Prepares special reports, briefs and analyses of all-source current intelligence for Agency officials and other governmental officials, and provides continuing assistance for other CIA components.
- e. Executes projects in the reconstruction of critical events and developments for the purpose of testing hypotheses concerning Soviet and Satellite plans and actions and in the interest of more definitive conclusions concerning current trends, and prepares indications briefs and reports for the AD/CI and the DD/I.

Approved For Release 2000/04/19 : CIA-RDP79B01737A001100010001-8

SECRET

SECRET

Approved For Release 2000/04/19 : CIA-RDP79B01737A001100010001-8

Soviet Staff (Continued)

- f. In coordination with Presentations Division, prepares and presents current intelligence briefings for OCI, CIA and other governmental officials.
- g. Prepares reports and briefs of indications material for inclusion in the agenda of the IAC Watch Committee, and provides representation on, and coordinates CIA support for, the Indications Center of the IAC Watch Committee.
- h. Provides intelligence support, requirements and indications guidance for overseas OCI elements.
- i. Develops requirements for all-source current information and initiates requests for special materials and information.
- j. Conducts continuing desk-level liaison with CIA, IAC, and USCIB components in order to obtain data and, as appropriate, analyses on subjects of mutual concern and specialized interest.
- k. Conducts a continuing review and revision of hypotheses and conclusions relating to political, military and economic indications; and develops indicator checklists, indications guides, and procedures for analyzing all-source current information in terms of indications.
- l. Serves, through the Staff Chief, as a member of the OCI Career Service Board.

Approved For Release 2000/04/19 : CIA-RDP79B01737A001100010001-8

SECRET

~~SECRET~~

Approved For Release 2000/04/19 : CIA-RDP79B01737A001100010001-8

STATEMENT OF MISSION AND FUNCTIONS

OFFICE OF CURRENT INTELLIGENCE

SOVIET STAFF

GENERAL DIVISION

I. MISSION

The General Division will analyze all-source current information and produce current intelligence reports, briefings, and items for OCI publications concerning political affairs and indications of political vulnerabilities, capabilities, and intentions of the U.S.S.R., the Soviet Bloc, and the international Communist movement; will integrate, as appropriate, all current intelligence relating to this area, and will provide briefings and other current intelligence support for other CIA components.

II. FUNCTIONS

With regard to the above-named areas and groups:

- a. Analyzes all-source political information and intelligence, and prepares evaluations and comments concerning political developments, activities and trends of current importance or significance for inclusion in regular or special OCI publications.
- b. Produces current intelligence reports, briefings and items for OCI publications concerning general affairs, integrating political, economic, military and other current intelligence as appropriate.
- c. Selects, on the basis of a political indicator checklist, significant or critical items and prepares reports, summaries or briefs concerning political trends, capabilities, vulnerabilities and probable developments for use by the Director and in support of the National Indications Center and the IAC Watch Committee.
- d. Prepares for the Director of Central Intelligence, his deputies and other CIA officials, special reports, briefs and analyses of all-source current intelligence, and provides continuing assistance for other CIA components.

Approved For Release 2000/04/19 : CIA-RDP79B01737A001100010001-8

~~SECRET~~

SECRET

Approved For Release 2000/04/19 : CIA-RDP79B01737A001100010001-8
General Division
Soviet Staff (Continued)

- e. Surveys past political events and activities, develops hypotheses on political intelligence problems and prepares reports projecting past political trends and present developments into the future for guidance of the Chief, Soviet Staff, the AD/CI and other CIA officials.
- f. In consultation with Presentations Division, prepares material for, and presents, political current intelligence briefings for OCI and CIA and other governmental officials.
- g. Reviews information received from present sources, including overseas OCI elements, in relation to the political indications checklist, and recommends further development of sources of political indications material.
- h. In consultation with Special Intelligence Staff, develops requirements for all-source current political information and initiates requests for special materials.
- i. Conducts continuing liaison with other OCI, CIA, IAC, and USCIB components in order to obtain and coordinate data and analyses concerning political information and in order to develop consolidated evaluations of all-source current information.
- j. Prepares all-source current political intelligence indicators, and maintains chronologies and other survey aids for use in preparing indications reports.
- k. Serves, through the Division Chief, as a permanent member of the Publications Board.

SECRET

Approved For Release 2000/04/19 : CIA-RDP79B01737A001100010001-8

STATEMENT OF MISSION AND FUNCTIONS

OFFICE OF CURRENT INTELLIGENCE

SOVIET STAFF

GENERAL DIVISION

SOVIET INTERNAL AFFAIRS BRANCH

I. MISSION

The Soviet Internal Affairs Branch will analyze all-source current information and produce current intelligence reports, briefings and items for OCI publications concerning internal U.S.S.R. political affairs and indications of internal political capabilities, vulnerabilities and intentions; will integrate, as appropriate, all current intelligence relating to internal U.S.S.R. political affairs, and will provide briefing and other current intelligence support for other CIA components.

II. FUNCTIONS

- a. Analyzes all-source political information and intelligence and prepares evaluations and comments concerning internal political developments, activities, and trends of current importance or significance, for inclusion in regular and special OCI publications.
- b. Produces current intelligence reports, briefings and items for OCI publications concerning general Soviet internal political developments, activities, and trends of current importance or significance, for inclusion in regular and special OCI publications.
- c. Selects, on the basis of a political indicator checklist, critical and significant items and prepares reports, summaries or briefs concerning internal U.S.S.R. political trends, capabilities, vulnerabilities and probable developments for use by the Director and in support of the National Indications Center and the IAC Watch Committee.
- d. Prepares for the Director of Central Intelligence, his deputies, and other CIA officials, special reports, briefs and analyses of all-source current intelligence on internal U.S.S.R. political matters, and provides continuing assistance for other CIA components.

Approved For Release 2000/04/19 : CIA-RDP79B01737A001100010001-8

SECRET

SECRET

Approved For Release 2000/04/19 : CIA-RDP79B01737A001100010001-8
Soviet Staff
General Division
Soviet Internal Affairs Branch

- e. Surveys past internal political events and activities, develops hypotheses on political intelligence problems and prepares reports projecting past political trends and present developments into the future for guidance of OCI and CIA officials.
- f. In consultation with the Presentations Division, prepares materials for, and presents, political current intelligence briefings for OCI, CIA and other government officials.
- g. Reviews information received from present sources, including overseas OCI elements, in relation to the political indications checklist, and recommends further development of sources of political indications material.
- h. In consultation with Special Intelligence Staff, develops requirements for all-source current political information and initiates requests for special materials.
- i. Conducts continuing liaison with other OCI, CIA, IAC and USCIB components in order to obtain and coordinate data and analyses concerning political information and in order to develop consolidated evaluations of all-source current information.
- j. Prepares all-source current political intelligence indicators, and maintains chronologies, and other survey aids for use in preparing indications reports.

Approved For Release 2000/04/19 : CIA-RDP79B01737A001100010001-8

SECRET

SECRET

Approved For Release 2000/04/19 : CIA-RDP79B01737A001100010001-8

STATEMENT OF MISSION AND FUNCTIONS

OFFICE OF CURRENT INTELLIGENCE

SOVIET STAFF

GENERAL DIVISION

SOVIET FOREIGN POLICY BRANCH

I. MISSION

The Soviet Foreign Policy Branch will analyze all-source current information and produce current intelligence reports, briefings and items for OCI publications concerning U.S.S.R. policy and propaganda throughout the non-Communist world and indications of external U.S.S.R. political vulnerabilities, capabilities and intentions; will integrate, as appropriate, all current intelligence relating to Soviet foreign policy, and will provide briefing and other current intelligence support for other CIA components.

II. FUNCTIONS

- a. Analyzes all-source current political information and intelligence and prepares evaluations and comments concerning Soviet foreign policy developments, activities and trends of current importance or significance for inclusion in regular or special OCI publications.
- b. Produces current intelligence reports, briefings and items for OCI publications concerning general Soviet foreign policy affairs, integrating political, economic, military and other current intelligence as appropriate.
- c. Selects, on the basis of a political indicator checklist, significant or critical items and prepares reports, summaries or briefs indicating foreign policy trends, capabilities, vulnerabilities and probable developments for use by the Director and in support of the National Indications Center and the IAC Watch Committee.
- d. Prepares for the Director of Central Intelligence, his deputies and other CIA officials, special reports, briefs and analyses of all-source current intelligence, and provides continuing assistance for other CIA components.

Approved For Release 2000/04/19 : CIA-RDP79B01737A001100010001-8

SECRET

SECRET

Approved For Release 2000/04/19 : CIA-RDP79B01737A001100010001-8

Soviet Staff
General Division
Soviet Foreign Policy Branch

- e. Surveys past foreign policy events and activities, develops hypotheses on foreign policy problems and prepares reports projecting past political events and present developments into the future for the guidance of the OCI and other CIA officials.
- f. In consultation with the Presentations Division, prepares material for, and presents political current intelligence briefings for, OCI and CIA and other governmental officials.
- g. In consultation with the Special Intelligence Staff, develops requirements for all-source current political information and initiates requests for special materials.
- h. Reviews information received from present sources, including overseas OCI elements, in relation to the political indications checklist, and recommends further development of sources of political indications material.
- i. Conducts continuing liaison with other OCI, CIA, IAC, and USCIB components in order to obtain and coordinate data and analyses concerning political information and in order to develop consolidated evaluations of all-source current information.
- j. Prepares all-source current political intelligence indicators, and maintains chronologies and other survey aids for use in preparing indications reports.

Approved For Release 2000/04/19 : CIA-RDP79B01737A001100010001-8

SECRET

SECRET

Approved For Release 2000/04/19 : CIA-RDP79B01737A001100010001-8

STATEMENT OF MISSION AND FUNCTIONS

OFFICE OF CURRENT INTELLIGENCE

SOVIET STAFF

GENERAL DIVISION

EASTERN EUROPEAN BRANCH

I. MISSION

The Eastern European Branch will analyze all-source current information and produce current intelligence reports, briefings and items for OCI publications concerning political affairs and indications of political vulnerabilities, capabilities and intentions of the Eastern European Satellites of the U.S.S. R., Yugoslavia and Trieste; will integrate, as appropriate, political, military, economic and other current intelligence relating to these countries, and will provide briefing and other current intelligence support for other CIA components.

II. FUNCTIONS

With regard to the above named countries:

- a. Analyzes all-source political information and intelligence, and prepares evaluations and comments concerning political developments, activities and trends of current importance or significance for inclusion in regular or special OCI publications.
- b. Produces current intelligence reports, briefings and items for OCI publications concerning general affairs, integrating political, sociological, economic, military, and other current intelligence as appropriate.
- c. Selects, on the basis of a political indicator checklist, significant or critical items and prepares reports, summaries, or briefs concerning political trends, capabilities, vulnerabilities and probable developments for use by the Director and in support of the National Indications Center and the IAC Watch Committee.

Approved For Release 2000/04/19 : CIA-RDP79B01737A001100010001-8

SECRET

SECRET

Approved For Release 2000/04/19 : CIA-RDP79B01737A001100010001-8

Soviet Staff
General Division
Eastern European Branch

- d. Prepares for the Director of Central Intelligence, his deputies and other CIA officials special reports, briefs, and analyses of all-source current intelligence and provides continuing assistance for other CIA components.
- e. Surveys past political events and activities, develops hypotheses on political intelligence problems and prepares reports projecting political trends and present developments into the future for guidance of OCI and other CIA officials.
- f. In consultation with Presentations Division, prepares material for, and presents, political current intelligence briefings for OCI, CIA and other governmental officials.
- g. Reviews information received from present sources, including overseas OCI elements, in relation to the political indications checklist, and recommends further development of sources of political indications material.
- h. In consultation with Special Intelligence Staff, develops requirements for all-source current political information and initiates requests for special materials.
- i. Conducts continuing liaison with other OCI, CIA, IAC, and USCIB components in order to obtain and coordinate data and analyses concerning political information and in order to develop consolidated evaluations of all-source current information.
- j. Prepares all-source current political intelligence indicators, and maintains chronologies and other survey aids for use in preparing indications reports.

Approved For Release 2000/04/19 : CIA-RDP79B01737A001100010001-8

SECRET

SECRET

Approved For Release 2000/04/19 : CIA-RDP79B01737A001100010001-8

STATEMENT OF MISSION AND FUNCTIONS

OFFICE OF CURRENT INTELLIGENCE

SOVIET STAFF

ECONOMIC DIVISION

I. MISSION

The Economic Division will survey and analyze all-source economic intelligence and information obtained from CIA, other agencies and other sources concerning the U.S.S.R. and the Soviet Bloc; will prepare evaluations and interpretations for inclusion in OCI publications and briefings, and will provide briefing and other current intelligence support for other CIA components.

II. FUNCTIONS

With regard to the above named areas and drawing upon the professional resources of the Office of Research and Reports to the fullest extent:

- a. Surveys intelligence reports and materials from other agencies and from other offices of CIA, particularly ORR, and analyzes other all-source economic information in order to prepare evaluation of, and interpretive comments and reports on, economic developments, activities and trends of current intelligence significance for inclusion in regular or special OCI reports, publications and briefings.
- b. Selects, on the basis of an economic indicator checklist, significant or critical items and prepares reports, summaries or briefs concerning economic trends, capabilities, vulnerabilities and probable developments for use by the Director and in support of the National Indications Center and the IAC Watch Committee.
- c. In conjunction with other units of OCI, surveys past economic events and activities in their relation to political, military, sociological and international developments and factors and develops therefrom hypotheses on Soviet intentions and capabilities in past periods and situations and prepares reports projecting these trends and present developments into the future for guidance of the Chief, Soviet Staff, the AD/CI and other CIA officials.

Approved For Release 2000/04/19 : CIA-RDP79B01737A001100010001-8

SECRET

SECRET

Approved For Release 2000/04/19 : CIA-RDP79B01737A001100010001-8
Special Staff
Economic Division

- d. In consultation with the Special Intelligence Staff, initiates requirements for all-source current economic information and intelligence bearing on immediate current intelligence problems and develops, in conjunction with ORR, requirements for exploitation of sources of economic indications material.
- e. Conducts continuing liaison with other OCI, CIA, IAC and USCIB components in order to obtain and coordinate data and analysis concerning current economic developments.
- f. Maintains a continuing survey of intelligence collection and research programs and facilities in order to utilize to the fullest extent the technical and professional abilities available in the intelligence community in furtherance of the mission of OCI.
- g. Serves, through the Division Chief, as a permanent member of the OCI Publications Board.

Approved For Release 2000/04/19 : CIA-RDP79B01737A001100010001-8

SECRET

STATEMENT OF MISSION AND FUNCTIONS

OFFICE OF CURRENT INTELLIGENCE

SOVIET STAFF

ECONOMIC DIVISION

SOVIET ECONOMIC BRANCH

I. MISSION

The Soviet Economic Branch will analyze all-source current information and produce current intelligence reports, briefings and items for OCI publications concerning internal economic policies, activities and developments, and indications of internal economic vulnerabilities, capabilities and intentions of the U.S.S.R., and will provide briefing and other current intelligence support for other CIA components.

II. FUNCTIONS

- a. Analyzes all-source economic information and intelligence, and prepares evaluations and comments concerning economic developments, activities and trends of current importance or significance for inclusion in regular or special OCI publications.
- b. Selects, on the basis of an economic indicator checklist, significant or critical items and prepares reports, summaries or briefs concerning economic trends, capabilities, vulnerabilities and probable developments for use by the Director and in support of the National Indications Center and the IAC Watch Committee.
- c. Prepares for the Director of Central Intelligence, his deputies and other CIA officials, special reports, briefs and analyses of all-source current intelligence, and provides continuing assistance for other CIA components.
- d. Surveys past economic events and activities, develops hypotheses on economic intelligence problems and prepares reports projecting past economic trends and present developments into the future for guidance of the Chief, Economic Division, the Chief, Soviet Staff, the AD/CI and other CIA officials.

SECRET

Approved For Release 2000/04/19 : CIA-RDP79B01737A001100010001-8
Soviet Staff
Economic Division
Soviet Economic Branch

- e. In consultation with Presentations Division, prepares material for, and presents, economic current intelligence briefings for OCI and CIA and other governmental officials.
- f. Reviews information received from present sources, including overseas OCI elements, in relation to the economic indications checklist, and recommends further development of sources of economic indications material.
- g. In consultation with Special Intelligence Staff, develops requirements for all-source current economic information and initiates requests for special materials.
- h. Conducts continuing liaison with other OCI, CIA, IAC, and USCIB components in order to obtain and coordinate data and analyses concerning economic information and in order to develop consolidated evaluations of all-source current information.
- i. Prepares all-source current economic intelligence indicators, and maintains chronologies and other survey aids for use in preparing indications reports.

Approved For Release 2000/04/19 : CIA-RDP79B01737A001100010001-8

SECRET

SECRET

Approved For Release 2000/04/19 : CIA-RDP79B01737A001100010001-8

STATEMENT OF MISSION AND FUNCTIONS

OFFICE OF CURRENT INTELLIGENCE

SOVIET STAFF

ECONOMIC DIVISION

ORBIT ECONOMIC BRANCH

I. MISSION

The Orbit Economic Branch will analyze all-source current information and produce current intelligence reports, briefings and items for OCI publications concerning the economic policies, activities, developments and relations, and indications of economic vulnerabilities, capabilities and intentions of (a) the international economies of the U.S.S.R., its Eastern European Satellites, and Yugoslavia, and (b) the internal economies of the Eastern European Satellites, and Yugoslavia, and will provide briefing and other current intelligence support for other CIA components.

II. FUNCTIONS

- a. Analyzes all-source economic information and intelligence, and prepares evaluations and comments concerning economic developments, activities and trends of current importance or significance for inclusion in regular or special OCI publications.
- b. Selects, on the basis of an economic indicator checklist, significant or critical items and prepares reports, summaries or briefs concerning economic trends, capabilities, vulnerabilities and probable developments for use by the Director and in support of the National Indications Center and the IAC Watch Committee.
- c. Prepares for the Director of Central Intelligence, his deputies and other CIA officials, special reports, briefs and analyses of all-source current intelligence, and provides continuing assistance for other CIA components.
- d. Surveys past economic events and activities, develops hypotheses on economic intelligence problems and prepares reports projecting past economic trends and present developments into the future for guidance of the Chief, Economic Division, the Chief, Soviet Staff, the AD/CI and other CIA officials.

Approved For Release 2000/04/19 : CIA-RDP79B01737A001100010001-8

SECRET

SECRET

Approved For Release 2000/04/19 : CIA-RDP79B01737A001100010001-8

Economic Division
Orbit Economic Branch

- e. In consultation with Presentations Division, prepares material for, and presents, economic current intelligence briefings for OCI and CIA and other governmental officials.
- f. Reviews information received from present sources, including overseas OCI elements, in relation to the economic indications checklist, and recommends further development of sources of economic indications material.
- g. In consultation with Special Intelligence Staff, develops requirements for all-source current economic information and initiates requests for special materials.
- h. Conducts continuing liaison with other OCI, CIA, IAC, and USCIB components in order to obtain and coordinate data and analyses concerning economic information and in order to develop consolidated evaluations of all-source current information.
- i. Prepares all-source current economic intelligence indicators, and maintains chronologies and other survey aids for use in preparing indications reports.

Approved For Release 2000/04/19 : CIA-RDP79B01737A001100010001-8

SECRET

SECRET

Approved For Release 2000/04/19 : CIA-RDP79B01737A001100010001-8

STATEMENT OF MISSION AND FUNCTIONS

OFFICE OF CURRENT INTELLIGENCE

SOVIET STAFF

MILITARY DIVISION

I. MISSION

The Military Division will analyze all-source current information and intelligence provided by the Defense Department and other sources concerning military establishments, intentions, capabilities and vulnerabilities of the U.S.S.R. and the Soviet Bloc; will interpret military intelligence produced by Service agencies for guidance of the Assistant Director, Current Intelligence; will integrate Service-produced intelligence with OCI-produced material for inclusion in OCI publications, reports and briefings, and will provide briefing and other current intelligence support for other CIA components.

II. FUNCTIONS

With regard to the above-named areas:

- a. Analyzes all-source military intelligence and information and prepares evaluations, comments and interpretations on activities, trends and developments for inclusion in regular or special OCI publications.
- b. Prepares military current intelligence reports and briefings, integrating, where appropriate, intelligence produced by the Service agencies with OCI-produced material.
- c. Prepares reports and studies on indications of military capabilities, vulnerabilities and intentions for use by the Director and in support of the National Indications Center and the IAC Watch Committee.
- d. Surveys past military developments, activities and trends and prepares hypotheses and analyses for guidance of the Staff Chief, the AD/CI and other CIA Offices.

Approved For Release 2000/04/19 : CIA-RDP79B01737A001100010001-8

SECRET

Soviet Staff
Military Division

- e. In consultation with Presentations Division, prepares material for, and presents, military current intelligence briefings for OCI, CIA and other governmental officials.
- f. In consultation with Special Intelligence Staff, develops requirements for all-source current military information and initiates requests for special materials.
- g. Conducts continuing liaison with other OCI, CIA, IAC and USCIB components in order to obtain and coordinate data and analyses concerning military information and in order to develop consolidated evaluations of all-source information.
- h. Advises the Chief, Soviet Staff and the IAC Watch Committee in regard to the collection of military information and the production of military intelligence.
- i. Maintains order-of-battle reference materials on a world-wide basis, using information provided by the Services' intelligence agencies.
- j. Serves, through the Division Chief, as a permanent member of the OCI Publications Board.

SECRET

Approved For Release 2000/04/19 : CIA-RDP79B01737A001100010001-8

STATEMENT OF MISSION AND FUNCTIONS

OFFICE OF CURRENT INTELLIGENCE

SOVIET STAFF

MILITARY DIVISION

ARMY GROUND FORCES BRANCH

I. MISSION

The Army Ground Forces Branch will analyze all-source current information and intelligence provided by the Defense Department and other sources concerning the ground and paramilitary forces of the U.S.S.R. and the Soviet Bloc; will interpret ground and paramilitary intelligence produced by the U.S. Army for guidance of the Assistant Director, Current Intelligence; will integrate U.S. Army-produced intelligence into OCI-produced material for inclusion in OCI publications, reports and briefings, and will provide briefing and other current intelligence support for other CIA components.

II. FUNCTIONS

With regard to the above-named areas:

- a. Analyzes all-source ground and paramilitary forces intelligence and information and prepares evaluations, comments and interpretations on activities, trends and developments for inclusion in regular or special OCI publications.
- b. Prepares ground and paramilitary forces current intelligence reports and briefings, integrating, where appropriate, intelligence produced by the U.S. Army with OCI-produced material.
- c. Prepares reports and studies on indications of ground and paramilitary forces capabilities, vulnerabilities and intentions for use by the Director and in support of the National Indications Center and the IAC Watch Committee.
- d. Surveys past ground and paramilitary forces developments, activities and trends, and prepares hypotheses and analyses for guidance of the Staff Chief, the AD/CI and other CIA Offices.

Approved For Release 2000/04/19 : CIA-RDP79B01737A001100010001-8

SECRET

Soviet Staff
Military Division
Army Ground Forces Branch

SECRET

Approved For Release 2000/04/19 : CIA-RDP79B01737A001100010001-8

- e. In consultation with Presentations Division, prepares material for, and presents, ground and paramilitary forces current intelligence briefings for OCI, CIA and other governmental officials.
- f. In consultation with Special Intelligence Staff, develops requirements for all-source current ground and paramilitary forces information and initiates requests for special materials.
- g. Conducts continuing liaison with other OCI, CIA, IAC and USCIB components in order to obtain and coordinate data and analyses concerning ground and paramilitary forces information and in order to develop consolidated evaluations of all-source information.
- h. Advises the Chief, Military Division and the IAC Watch Committee in regard to the collection of ground and paramilitary forces information and the production of ground and paramilitary forces intelligence.
- i. Maintains order-of-battle reference materials on a world-wide basis, using information provided by U.S. Army intelligence.

Approved For Release 2000/04/19 : CIA-RDP79B01737A001100010001-8

SECRET

SECRET

Approved For Release 2000/04/19 : CIA-RDP79B01737A001100010001-8

STATEMENT OF MISSION AND FUNCTIONS

OFFICE OF CURRENT INTELLIGENCE

SOVIET STAFF

MILITARY DIVISION

NAVY AND TECHNICAL BRANCH

I. MISSION

The Navy and Technical Branch will analyze all-source current information and intelligence provided by the Defense Department and other sources concerning the navies of the U.S.S.R. and the Soviet Bloc; will interpret naval intelligence produced by the U.S. Navy for guidance of the Assistant Director, Current Intelligence; will integrate U.S. Navy-produced intelligence into OCI-produced material for inclusion in OCI publications, reports and briefings, and will provide briefing and other current intelligence support for other CIA components.

II. FUNCTIONS

With regard to the above-named areas:

- a. Analyzes all-source naval intelligence and information and prepares evaluations, comments and interpretations on activities, trends and developments for inclusion in regular or special OCI publications.
- b. Prepares naval current intelligence reports and briefings, integrating, where appropriate, intelligence produced by the U.S. Navy with OCI-produced material.
- c. Prepares reports and studies on indications of naval capabilities, vulnerabilities and intentions for use by the Director and in support of the National Indications Center and the IAC Watch Committee.
- d. Surveys past naval developments, activities and trends, and prepares hypotheses and analyses for guidance of the Staff Chief, the AD/CI and other CIA Offices.

Approved For Release 2000/04/19 : CIA-RDP79B01737A001100010001-8

SECRET

STATEMENT OF MISSION AND FUNCTIONS

OFFICE OF CURRENT INTELLIGENCE

SOVIET STAFF

MILITARY DIVISION

AIR FORCES BRANCH

I. MISSION

The Air Forces Branch will analyze all-source current information and intelligence provided by the Defense Department and other sources concerning the air forces of the U.S.S.R. and the Soviet Bloc; will interpret air forces intelligence produced by the U.S. Air Force for guidance of the Assistant Director, Current Intelligence; will integrate U.S. Air Force-produced intelligence into OCI-produced material for inclusion in OCI publications, reports and briefings, and will provide briefing and other current intelligence support for other CIA components.

II. FUNCTIONS

With regard to the above-named areas:

- a. Analyzes all-source air force intelligence and information and prepares evaluations, comments and interpretations on activities, trends and developments for inclusion in regular or special OCI publications.
- b. Prepares air force current intelligence reports and briefings, integrating, where appropriate, intelligence produced by the U.S. Air Force with OCI-produced material.
- c. Prepares reports and studies on indications of air forces capabilities, vulnerabilities and intentions for use by the Director and in support of the National Indications Center and the IAC Watch Committee.
- d. Surveys past air forces developments, activities and trends, and prepares hypotheses and analyses for guidance of the Staff Chief, the AD/ CI and other CIA Offices.

Soviet Staff

SECRET

Approved For Release 2000/04/19 : CIA-RDP79B01737A001100010001-8

Air Forces Branch

- e. In consultation with Presentations Division, prepares material for, and presents, air forces current intelligence briefings for OCI, CIA and other governmental officials.
- f. In consultation with Special Intelligence Staff, develops requirements for all-source current air forces information and initiates requests for special materials.
- g. Conducts continuing liaison with other OCI, CIA, IAC and USCIB components in order to obtain and coordinate data and analyses concerning air forces information and in order to develop consolidated evaluations of all-source information.
- h. Advises the Chief, Military Division and the IAC Watch Committee in regard to the collection of air forces information and the production of air forces intelligence.
- i. Maintains order-of-battle reference materials on a world-wide basis, using information provided by U.S. Air Force intelligence.

Approved For Release 2000/04/19 : CIA-RDP79B01737A001100010001-8

SECRET

SECRET

Approved For Release 2000/04/19 : CIA-RDP79B01737A001100010001-8

STATEMENT OF MISSION AND FUNCTIONS

OFFICE OF CURRENT INTELLIGENCE

PRODUCTION STAFF

I. MISSION

The Production Staff will, through its Chief, provide a Chairman of the Publications Board; will advise the Assistant Director in regard to the production of current intelligence publications and briefings; will review, edit and produce current intelligence publications, issuances and briefings, and will provide a 24-hour watch over incoming information in order to alert appropriate officials on receipt of important information.

II. FUNCTIONS

- a. Reviews and edits material submitted for written or verbal presentation, in terms of current value, conformity with OCI policies and editorial adequacy, and recommends revision or addition where necessary, and determines that necessary CIA coordination has been accomplished where appropriate.
- b. Prepares workload and publications schedules for OCI publications and controls adherence to schedules by OCI production components.
- c. Advises the Assistant Director, Current Intelligence, the Publications Board, and OCI personnel in the development of standards for current and proposed OCI publications, presentations and issuances.
- d. Scans incoming cables and teletypes in order to alert appropriate government officials upon receipt of important information and provides the CIA Watch Office.
- e. Advises OCI components in the development of material for written or verbal presentation, and provides graphics and reference material for use in such presentations.
- f. Plans, reviews, and coordinates all printing and reproduction of, CIA COMINT AND OCI all-source publications and issuances.
- g. Prepares special publications for dissemination to the AD/CI and other Agency officials, upon receipt of important or significant information.

Approved For Release 2000/04/19 : CIA-RDP79B01737A001100010001-8

SECRET

SECRET

Approved For Release 2000/04/19 : CIA-RDP79B01737A001100010001-8

Production Staff

- h. Controls dissemination of OCI publications.
- i. Arranges and coordinates current intelligence support for the Office of National Estimates and the National Security Planning Board, and the Director of Central Intelligence.
- j. Serves, through the Staff Chief, as a permanent member of the OCI Career Service Board.

Approved For Release 2000/04/19 : CIA-RDP79B01737A001100010001-8

SECRET

SECRET

Approved For Release 2000/04/19 : CIA-RDP79B01737A001100010001-8

STATEMENT OF MISSION AND FUNCTIONS

OFFICE OF CURRENT INTELLIGENCE

PRODUCTION STAFF

SECRETARIAT

I. MISSION

The Secretariat will scan all-source current information and will alert CIA officials upon receipt of important information, will prepare special current intelligence reports for the Director of Central Intelligence, will supervise the reproduction of OCI publications and will serve as executive secretary to the Publications Board.

II. FUNCTIONS

- a. Scans all incoming cables, teletypes and news tickers and selects items of an important or significant nature, and maintains and supervises the 24-hour CIA Watch Office.
- b. Prepares special publications and reports, such as the Daily Watchpot, the Director's Daily Digest and cable briefs, designed to alert the Director, his deputies, the Assistant Director, Current Intelligence and other CIA officials on the receipt of important or significant information.
- c. Controls dissemination of special reports, such as intelligence notes.
- d. Prepares and maintains continuing indexes to all OCI current intelligence publications for reference use by CIA components.
- e. Serves as executive secretary to, and member of, the Publications Board, prepares material for the Board's agenda, alerts the Board to the receipt of important information, and assists in determining OCI publications content, policies and standards.
- f. Prescribes reproduction schedules for OCI publications, controls adherence to schedules and conducts continuing liaison with the Office of General Services in regard to printing and reproduction facilities within the Special Center.

Approved For Release 2000/04/19 : CIA-RDP79B01737A001100010001-8

SECRET

SECRET

Approved For Release 2000/04/19 : CIA-RDP79B01737A001100010001-8

Production Staff
Secretariat

- g. Prescribes design and layout for all OCI publications.
- h. Reviews requests for reproduction of all CIA COMINT publications in the Special Center and determines action to be taken.
- i. Receives, and serves as custodian of, State Department S/S cables.
- j. Conducts continuing liaison with all CIA components where necessary to obtain materials for inclusion in OCI publications.

Approved For Release 2000/04/19 : CIA-RDP79B01737A001100010001-8

SECRET

~~SECRET~~

Approved For Release 2000/04/19 : CIA-RDP79B01737A001100010001-8

STATEMENT OF MISSION AND FUNCTIONS

OFFICE OF CURRENT INTELLIGENCE

PRODUCTION STAFF

SECRETARIAT

I. MISSION

The Secretariat will scan all-source current information and will alert CIA officials upon receipt of important information, will prepare special current intelligence reports for the Director of Central Intelligence, will supervise the reproduction of OCI publications and will serve as executive secretary to the Publications Board.

II. FUNCTIONS

- a. Scans all incoming cables, teletypes and news tickers and selects items of an important or significant nature, and maintains and supervises the 24-hour CIA Watch Office.
- b. Prepares special publications and reports, such as the Daily Watchpot, the Director's Daily Digest and cable briefs, designed to alert the Director, his deputies, the Assistant Director, Current Intelligence and other CIA officials on the receipt of important or significant information.
- c. Controls dissemination of special reports, such as intelligence notes.
- d. Prepares and maintains continuing indexes to all OCI current intelligence publications for reference use by CIA components.
- e. Serves as executive secretary to, and member of, the Publications Board, prepares material for the Board's agenda, alerts the Board to the receipt of important information, and assists in determining OCI publications content, policies and standards.
- f. Prescribes reproduction schedules for OCI publications, controls adherence to schedules and conducts continuing liaison with the Office of General Services in regard to printing and reproduction facilities within the Special Center.

Approved For Release 2000/04/19 : CIA-RDP79B01737A001100010001-8

~~SECRET~~

SECRET

Approved For Release 2000/04/19 : CIA-RDP79B01737A001100010001-8

Production Staff
Secretariat

- g. Prescribes design and layout for all OCI publications.
- h. Reviews requests for reproduction of all CIA COMINT publications in the Special Center and determines action to be taken.
- i. Receives, and serves as custodian of, State Department S/S cables.
- j. Conducts continuing liaison with all CIA components where necessary to obtain materials for inclusion in OCI publications.

Approved For Release 2000/04/19 : CIA-RDP79B01737A001100010001-8

SECRET

SECRET

Approved For Release 2000/04/19 : CIA-RDP79B01737A001100010001-8

STATEMENT OF MISSION AND FUNCTIONS

OFFICE OF CURRENT INTELLIGENCE

PRODUCTION STAFF

EDITORIAL DIVISION

I. MISSION

The Editorial Division will review all items submitted for inclusion in OCI publications and special current intelligence issuances for adherence to prescribed editorial standards, and will guide and assist OCI production components in the preparation of materials for OCI publications.

II. FUNCTIONS

- a. Reads items submitted for inclusion in OCI publications and special current intelligence issuances for adherence to established OCI policies and standards for style, format, substantive value and timeliness, and if necessary, revises material or submits material for revision by originators.
- b. Provides continuing advice and assistance to OCI components preparing materials for OCI publications.
- c. In consultation with production components, prepares publications schedules and conducts continuing liaison with such components to insure maintenance of schedules.
- d. Provides, through the division chief, a permanent member of the Publications Board, who acts as chairman of the Board in the absence of the chairman.
- e. Prepares style manuals and other technical guides for maintaining the standards of OCI publications.
- f. Conducts liaison with the State Department concerning receipt and utilization by CIA of State Department Information Only cables.
- g. Prepares dissemination lists of recipients of OCI publications, on the basis of content of publications and recipients' requirements.

Approved For Release 2000/04/19 : CIA-RDP79B01737A001100010001-8

SECRET

STATEMENT OF MISSION AND FUNCTIONS

OFFICE OF CURRENT INTELLIGENCE

PRODUCTION STAFF

PRESENTATIONS DIVISION

I. MISSION

The Presentations Division will administer, arrange or present all-source current intelligence briefings or debriefings requiring participation by OCI, and will prepare graphics and reference material for use in briefings and in current intelligence publications.

II. FUNCTIONS

- a. In consultation with the appropriate OCI staff chiefs and other CIA components, selects topics, schedules the program and advises on personnel to participate in briefings or debriefings on current intelligence subjects.
- b. Delivers as required for various audiences current intelligence briefings based upon information received from OCI staffs and divisions and other CIA components.
- c. Schedules and controls the use of the Situation Room and other OCI conference rooms.
- d. Prepares maps, charts, drawings and other graphics materials for use in briefings.
- e. Prepares special graphics material for reference display purposes, for OCI publications and other graphics support as directed by the Chief, Production Staff, or the Assistant Director, Current Intelligence.
- f. Plans and supervises the production of Current Intelligence handbooks and certain non-graphics reference materials.
- g. Serves, through the Division Chief, as a member of the Publications Board.
- h. Conducts liaison with CIA components and maintains files of intelligence and graphics materials incident to the division's mission.

SECRET

Approved For Release 2000/04/19 : CIA-RDP79B01737A001100010001-8

STATEMENT OF MISSION AND FUNCTIONS

OFFICE OF CURRENT INTELLIGENCE

PRODUCTION STAFF

PRESENTATIONS DIVISION

PLANNING AND COORDINATION BRANCH

I. MISSION

The Planning and Coordination Branch will plan, schedule and arrange for the conduct of all-source current intelligence briefings or debriefings requiring OCI participation and will maintain certain non-graphics reference materials relating to current intelligence.

II. FUNCTIONS

- a. Reviews intelligence material on a continuing basis for briefing purposes, coordinates the content of briefings with OCI substantive staffs and other CIA components and presents briefings of a general nature as required.
- b. Selects special topics for briefings, consults with OCI substantive staffs and other CIA components regarding content of briefings and personnel to present them, schedules briefings and makes necessary arrangements for the conduct of briefings.
- c. Conducts staff work for the AD/CI on OCI participation in briefings to be given by the Director of General Intelligence or his deputies.
- d. Supervises the preparation by OCI divisions of Current Intelligence handbooks and other non-graphics reference materials.

Approved For Release 2000/04/19 : CIA-RDP79B01737A001100010001-8

SECRET

SECRET

Approved For Release 2000/04/19 : CIA-RDP79B01737A001100010001-8

STATEMENT OF MISSION AND FUNCTIONS

OFFICE OF CURRENT INTELLIGENCE

PRODUCTION STAFF

PRESENTATIONS DIVISION

TECHNICAL BRANCH

I. MISSION

The Technical Branch will prepare all graphic presentations for use in current intelligence briefings, OCI publications and displays, and for reference purposes.

II. FUNCTIONS

- a. Advises the Chief, Production Staff, the Assistant Director, Current Intelligence, and other OCI personnel regarding the application of graphics presentations to intelligence material.
- b. Prepares maps, charts, graphs and other illustrative materials for use in the conduct of special or regularly scheduled current intelligence briefings.
- c. Prepares special graphic presentations upon direction of the Chief, Production Staff, or the Assistant Director, Current Intelligence, for use by other CIA components or non-CIA agencies in conducting briefings.
- d. Prepares graphic materials for all OCI intelligence publications.
- e. Prepares and maintains graphics displays and graphics reference material on current intelligence.
- f. Conducts liaison with other CIA and IAC components in order to obtain data used in graphic presentations.

Approved For Release 2000/04/19 : CIA-RDP79B01737A001100010001-8

SECRET

SECRET

Approved For Release 2000/04/19 : CIA-RDP79B01737A001100010001-8

STATEMENT OF MISSION AND FUNCTIONS

OFFICE OF CURRENT INTELLIGENCE

PUBLICATIONS BOARD

I. MISSION

The Publications Board, under the chairmanship of the Chief, Production Staff, will review and approve publication of items in the Current Intelligence Bulletin and the Current Intelligence Review, and in special issuances, and will review other current intelligence publications for adherence to Office policies and publications criteria.

II. FUNCTIONS

- a. Reviews current intelligence items and articles submitted for publication through the Production Staff in terms of substantive value, conformity with OCI policies and requirements and editorial accuracy.
- b. Selects items of current importance for inclusion in the Current Intelligence Bulletin or the Current Intelligence Review, or for dissemination as Intelligence Notes, Intelligence Memoranda or other special issuances.
- c. Reviews other OCI current intelligence publications, after publication, for adherence to Office policies, criteria and objectives.
- d. Advises the Assistant Director, Current Intelligence, and OCI personnel regarding the substantive and editorial aspects of current and proposed OCI current intelligence publications and issuances.

Approved For Release 2000/04/19 : CIA-RDP79B01737A001100010001-8

SECRET

SECRET

Approved For Release 2000/04/19 : CIA-RDP79B01737A001100010001-8

STATEMENT OF MISSION AND FUNCTIONS

OFFICE OF CURRENT INTELLIGENCE

REGIONAL STAFF

WESTERN DIVISION

I. MISSION

The Western Division, under the direction of the Chief, Regional Staff, will produce, after necessary coordination with other CIA components, all-source current intelligence reports and items for OCI publications concerning specified Western European and Northern European countries, Scandinavian and British Commonwealth countries, and Latin American countries, and organizations for European integration and related affairs, and will provide briefing and other current intelligence support for other CIA components.

II. FUNCTIONS

With regard to the above-named countries and areas:

- a. Analyzes all-source current information and prepares evaluations and comments concerning developments, activities and trends of current importance or significance, for inclusion in regular and special OCI publications.
- b. Prepares for the Director of Central Intelligence, his deputies and other CIA officials and personnel special reports, briefs and analyses of all-source current intelligence pertaining to the area, and provides continuing assistance for other CIA components in matters relating to the area.
- c. Serves, through the division chief, as a permanent member of the Publications Board to coordinate production activities and to establish current intelligence publication policies and standards.
- d. In consultation with the Presentations Division, prepares special detailed briefing material and presents current intelligence briefings for OCI, CIA, and other governmental officials.
- e. In consultation with the Special Intelligence Staff, develops requirements for all-source current information and initiates requests for special materials.

Approved For Release 2000/04/19 : CIA-RDP79B01737A001100010001-8

SECRET

- f. Prepares all-source current intelligence indicators, for the use of the Indications Center, in coordination with the Soviet Staff.
- g. Conducts continuing liaison with other CIA, IAC and USCIB components in order to obtain detailed data and analyses concerning specialized areas or areas of mutual responsibility and in order to develop consolidated evaluations of all-source current information.

STATEMENT OF MISSION AND FUNCTIONS

OFFICE OF CURRENT INTELLIGENCE

REGIONAL STAFF

I. MISSION

The Regional Staff will plan, coordinate and produce all-source current intelligence on foreign countries, not including the USSR and its European Satellites, and will provide briefing and other current intelligence support for other CIA components.

II. FUNCTIONS

- a. Serves, through the Staff Chief, as a permanent member of the Publications Board.
- b. Analyzes all-source current information, evaluates and comments upon material of current importance or significance, and prepares items and articles for inclusion in regular and special OCI publications.
- c. Prepares special reports, briefs and analyses of all-source current intelligence for Agency officials and personnel and other governmental officials, and provides continuing assistance for other CIA components in current intelligence matters relating to the assigned area.
- d. In coordination with Presentations Division, prepares and presents current intelligence briefings for OCI, CIA and other governmental officials.
- e. Develops requirements for all-source current information and initiates requests for special materials and information.
- f. Conducts continuing desk-level liaison with CIA, IAC and USCIB components in order to obtain detailed data and, as appropriate, analyses on subjects of mutual concern and specialized interest.
- g. Prepares current intelligence reports on trends and indications, in coordination with the Soviet Staff, for support of the Indications Center of the IAC Watch Committee.
- h. Provides intelligence support and requirements guidance for overseas OCI elements.
- i. Serves, through the Staff Chief, as a member of the OCI Career Service Board.

SECRET

Approved For Release 2000/04/19 : CIA-RDP79B01737A001100010001-8

STATEMENT OF MISSION AND FUNCTIONS

OFFICE OF CURRENT INTELLIGENCE

REGIONAL STAFF

WESTERN DIVISION

WESTERN EUROPE BRANCH

I. MISSION

The Western Europe Branch will prepare all-source current intelligence reports and items for OCI publications as related to France, the Benelux countries, Spain, Portugal, Italy, Switzerland, West Germany, Austria, and the colonial and foreign policies of these countries, and will provide briefing and other current intelligence support for other CIA components.

II. FUNCTIONS

With regard to the above-named countries and areas:

- a. Analyzes all-source current information and prepares evaluations and comments regarding items of current importance or significance.
- b. Coordinates closely with other CIA components in order to obtain detailed information and analyses on subjects of mutual concern and in specialized areas.
- c. Prepares regular and special reports and items for inclusion in OCI publications.
- d. Prepares special material for, and presents, briefings on current intelligence matters for OCI, CIA and other governmental officials.
- e. Prepares special detailed current intelligence briefs, analyses and reports for use by CIA representatives on IAC and other committees, and upon request by other CIA components.
- f. Acts as advisor to the Publications Board in matters relating to the assigned countries.
- g. Consults with personnel of the Special Intelligence Staff to develop requirements for all-source current information and to initiate requests for special materials.
- h. Prepares, in conjunction with the Soviet Staff, all-source current intelligence indicators relating to the assigned countries.

Approved For Release 2000/04/19 : CIA-RDP79B01737A001100010001-8

SECRET

STATEMENT OF MISSION AND FUNCTIONS

OFFICE OF CURRENT INTELLIGENCE

REGIONAL STAFF

WESTERN DIVISION

NORTHERN EUROPE BRANCH

I. MISSION

The Northern Europe Branch will prepare all-source current intelligence reports and items for OCI publications as related to the United Kingdom, Ireland, Canada, Sweden, Denmark, Norway, Iceland, Finland, to Danish colonial policies and to major British colonial policies with all dependencies, Commonwealth relations, and to British world-wide foreign policy, and will provide briefing and other current intelligence support for other CIA components.

II. FUNCTIONS

With regard to the above-named countries and areas:

- a. Analyzes all-source current information and prepares evaluations and comments regarding items of current importance or significance.
- b. Coordinates closely with other CIA components in order to obtain detailed information and analyses on subjects of mutual concern and in specialized areas.
- c. Prepares regular and special reports and items for inclusion in OCI publications.
- d. Prepares special material for, and presents, briefings on current intelligence matters for OCI, CIA, and other governmental officials.
- e. Prepares special detailed current intelligence briefs, analyses, and reports for use by CIA representatives on IAC and other committees, and upon request by other CIA components.
- f. Acts as advisor to the Publications Board in matters relating to the assigned countries.
- g. Consults with personnel of the Special Intelligence Staff to develop requirements for all-source current information and to initiate requests for special materials.
- h. Prepares, in conjunction with the Soviet Staff, all-source current intelligence indicators relating to the assigned countries.

STATEMENT OF MISSION AND FUNCTIONS

OFFICE OF CURRENT INTELLIGENCE

REGIONAL STAFF

WESTERN DIVISION

EUROPEAN REGIONAL AFFAIRS BRANCH

I. MISSION

The European Regional Affairs Branch will prepare all-source current intelligence reports and items for OCI publications as related to general Western European economic trends, to political and economic organizations for Western European integration and to U.N. organizational matters (not including country relations with the U.N.), and will provide briefing and other current intelligence support for other CIA components.

II. FUNCTIONS

- a. Analyzes all-source current information and prepares evaluations and comments regarding economic trends, and the organization and relationships of such groups as the European Coal-Steel Community, European Defense Community, COCOM, which is involved in export controls of strategic materials, and related matters of current importance or significance.
- b. Prepares evaluations and comments and conducts a continuing appraisal of organizational matters involving the U.N. and its specialized agencies, collaborating where necessary with CIA components having responsibility for the evaluation of country relationships with the U.N.
- c. Prepares regular and special reports and items for inclusion in OCI publications.
- d. Coordinates closely with other CIA components in order to obtain detailed information and analyses in geographic and functional areas of mutual concern.
- e. Prepares special material for, and presents, briefings on current intelligence matters concerning the assigned areas of responsibility for OCI, CIA and other governmental officials.

Regional Staff

SECRET

Approved For Release 2000/04/19 : CIA-RDP79B01737A001100010001-8

European Regional Affairs Branch

- f. Prepares special detailed current intelligence briefs, analyses and reports for use by CIA representatives on IAC and other committees, and upon request by other CIA components.
- g. Acts as advisor to the Publications Board in matters relating to the assigned areas of responsibility.
- h. Consults with personnel of the Special Intelligence Staff to develop requirements for all-source current information and to initiate requests for special materials.
- i. Prepares, in conjunction with the Soviet Staff, all-source current intelligence indicators.

Approved For Release 2000/04/19 : CIA-RDP79B01737A001100010001-8

SECRET

STATEMENT OF MISSION AND FUNCTIONS

OFFICE OF CURRENT INTELLIGENCE

REGIONAL STAFF

WESTERN DIVISION

LATIN AMERICA BRANCH

I. MISSION

The Latin America Branch will prepare all-source current intelligence reports and items for OCI publications as related to Mexico, Guatemala, Honduras, British Honduras, El Salvador, Nicaragua, Panama, Costa Rica, Cuba, Dominican Republic, Haiti, British, French, and Dutch West Indies, Colombia, Ecuador, Peru, Bolivia, Chile, Argentina, Uruguay, Paraguay, Brazil, Venezuela, and the Guianas, and to regional Latin American affairs and policies and local organizations, and will provide briefing and other current intelligence support for other CIA components.

II. FUNCTIONS

With regard to the above-named countries and areas:

- a. Analyzes all-source current information and prepares evaluations and comments regarding items of current importance or significance.
- b. Coordinates closely with other CIA components in order to obtain detailed information and analyses on subjects of mutual concern and in specialized areas.
- c. Prepares regular and special reports and items for inclusion in OCI publications.
- d. Prepares special material for, and presents, briefings on current intelligence matters for OCI, CIA, and other governmental officials.
- e. Prepares special detailed current intelligence briefs, analyses, and reports for use by CIA representatives on IAC and other committees, and upon request by other CIA components.
- f. Acts as advisor to the Publications Board in matters relating to the assigned countries.
- g. Consults with personnel of the Special Intelligence Staff to develop requirements for all-source current information and to initiate requests for special materials.
- h. Prepares, in conjunction with the Soviet Staff, all-source current intelligence indicators relating to the assigned countries.

~~SECRET~~

Approved For Release 2000/04/19 : CIA-RDP79B01737A001100010001-8

STATEMENT OF MISSION AND FUNCTIONS

OFFICE OF CURRENT INTELLIGENCE

REGIONAL STAFF

NEAR EAST AFRICA DIVISION

I. MISSION

The Near East Africa Division, under the direction of the Chief, Regional Staff, will produce, after necessary coordination with other CIA components, all-source current intelligence reports and items for OCI publications concerning specified South Asian and African countries, Arab States and Greece, Turkey, Iran and Cyprus, and will provide briefing and other current intelligence support for other CIA components.

II. FUNCTIONS

With regard to the above-named countries and areas:

- a. Analyzes all-source current information and prepares evaluations and comments concerning developments, activities and trends of current importance or significance for inclusion in regular and special OCI publications.
- b. Prepares for the Director of Central Intelligence, his deputies and other CIA officials and personnel special reports, briefs and analyses of all-source current intelligence pertaining to the area, and provides continuing assistance for other CIA components in matters relating to the area.
- c. Serves, through the division chief, as a permanent member of the Publications Board to coordinate production activities and to establish current intelligence publication policies and standards.
- d. In consultation with the Presentations Division, prepares special detailed briefing material and presents current intelligence briefings for OCI, CIA and other governmental officials.
- e. In consultation with the Special Intelligence Staff, develops requirements for all-source current information and initiates request for special materials.
- f. Prepares all-source current intelligence indicators, for the use of the Indications Center, in coordination with the Soviet Staff.
- g. Conducts continuing liaison with other CIA, IAC and USCIB components in order to obtain detailed data and analyses concerning specialized areas or areas of mutual responsibility and in order to develop consolidated evaluations of all-source current

Approved For Release 2000/04/19 : CIA-RDP79B01737A001100010001-8

~~SECRET~~

SECRET

Approved For Release 2000/04/19 : CIA-RDP79B01737A001100010001-8

STATEMENT OF MISSION AND FUNCTIONS

OFFICE OF CURRENT INTELLIGENCE

REGIONAL STAFF

NEAR EAST AFRICA DIVISION

GREECE-TURKEY-IRAN BRANCH

I. MISSION

The Greece-Turkey-Iran Branch will prepare all-source current intelligence reports and items for OCI publications as related to Greece, Turkey, Iran and Cyprus, and will provide briefing and other current intelligence support for other CIA components.

II. FUNCTIONS

With regard to the above-named countries:

- a. Analyzes all-source current information and prepares evaluations and comments regarding items of current importance or significance.
- b. Coordinates closely with other CIA and IAC components in order to obtain detailed information and analyses on subjects of mutual concern and in specialized areas.
- c. Prepares regular and special reports and items for inclusion in OCI publications.
- d. Prepares special material for, and presents, briefings on current intelligence matters for OCI, CIA, and other governmental officials.
- e. Prepares special detailed current intelligence briefs, analyses, and reports for use by CIA representatives on IAC and other committees, and upon request by other CIA components.
- f. Acts as advisor to the Publications Board in matters relating to the assigned countries.
- g. Consults with personnel of the Special Intelligence Staff to develop requirements for all-source current information and to initiate requests for special materials.
- h. Prepares, in conjunction with the Soviet Staff, all-source current intelligence indicators relating to the assigned countries.

Approved For Release 2000/04/19 : CIA-RDP79B01737A001100010001-8

SECRET

SECRET

Approved For Release 2000/04/19 : CIA-RDP79B01737A001100010001-8

STATEMENT OF MISSION AND FUNCTIONS

OFFICE OF CURRENT INTELLIGENCE

REGIONAL STAFF

NEAR EAST AFRICA DIVISION

ARAB STATES BRANCH

I. MISSION

The Arab States Branch will prepare all-source current intelligence reports and items for OCI publications as related to Aden, Anglo-Egyptian Sudan, Bahrain, Egypt, Iraq, Israel, Jordan, Kuwait, Lebanon, Libya, Muscat, Oman, Qatar, Saudi Arabia, Syria, Trucial Sheikdoms and Yemen, and will provide briefing and other current intelligence support for other CIA components.

II. FUNCTIONS

With regard to the above-named countries and areas:

- a. Analyzes all-source current information and prepares evaluations and comments regarding items of current importance or significance.
- b. Coordinates closely with other CIA and IAC components in order to obtain detailed information and analyses on subjects of mutual concern and in specialized areas.
- c. Prepares regular and special reports and items for inclusion in OCI publications.
- d. Prepares special material for, and presents, briefings on current intelligence matters for OCI, CIA, and other governmental officials.
- e. Prepares special detailed current intelligence briefs, analyses, and reports for use by CIA representatives on IAC and other committees, and upon request by other CIA components.
- f. Acts as advisor to the Publications Board in matters relating to the assigned countries.
- g. Consults with personnel of the Special Intelligence Staff to develop requirements for all-source current information and to initiate requests for special materials.
- h. Prepares, in conjunction with the Soviet Staff, all-source current intelligence indicators relating to the assigned countries.

Approved For Release 2000/04/19 : CIA-RDP79B01737A001100010001-8

SECRET

~~SECRET~~

Approved For Release 2000/04/19 : CIA-RDP79B01737A001100010001-8

STATEMENT OF MISSION AND FUNCTIONS

OFFICE OF CURRENT INTELLIGENCE

REGIONAL STAFF

NEAR EAST AFRICA DIVISION

SOUTH ASIA BRANCH

I. MISSION

The South Asia Branch will prepare all-source current intelligence reports and items for OCI publications as related to Afghanistan, Bhutan, Sikkim, Nepal, Ceylon, French and Portuguese possessions in India, Giodar, Kashmir, Pakistan and adjacent islands, and will provide briefing and other current intelligence support for other CIA components.

II. FUNCTIONS

With regard to the above-named countries and areas:

- a. Analyzes all-source current information and prepares evaluations and comments regarding items of current importance or significance.
- b. Coordinates closely with other CIA and IAC components in order to obtain detailed information and analyses on subjects of mutual concern and in specialized areas.
- c. Prepares regular and special reports and items for inclusion in OCI publications.
- d. Prepares special material for, and presents, briefings on current intelligence matters for OCI, CIA, and other governmental officials.
- e. Prepares special detailed current intelligence briefs, analyses, and reports for use by CIA representatives on IAC and other committees, and upon request by other CIA components.
- f. Acts as advisor to the Publications Board in matters relating to the assigned countries.
- g. Consults with personnel of the Special Intelligence Staff to develop requirements for all-source current information and to initiate requests for special materials.
- h. Prepares, in conjunction with the Soviet Staff, all-source current intelligence indicators relating to the assigned countries.

Approved For Release 2000/04/19 : CIA-RDP79B01737A001100010001-8

~~SECRET~~

STATEMENT OF MISSION AND FUNCTIONS

OFFICE OF CURRENT INTELLIGENCE

REGIONAL STAFF

NEAR EAST AFRICA DIVISION

AFRICA BRANCH

I. MISSION

The Africa Branch will prepare all-source current intelligence reports and items for OCI publications as related to all of the African continent except Libya, Egypt and the Anglo-Egyptian Sudan, and will provide briefing and other current intelligence support for other CIA components.

II. FUNCTIONS

With regard to the above-named countries and areas:

- a. Analyzes all-source current information and prepares evaluations and comments regarding items of current importance or significance.
- b. Coordinates closely with other CIA and IAC components in order to obtain detailed information and analyses on subjects of mutual concern and in specialized areas.
- c. Prepares regular and special reports and items for inclusion in OCI publications.
- d. Prepares special material for, and presents, briefings on current intelligence matters for OCI, CIA, and other governmental officials.
- e. Prepares special detailed current intelligence briefs, analyses, and reports for use by CIA representatives on IAC and other committees, and upon request by other CIA components.
- f. Acts as advisor to the Publications Board in matters relating to the assigned countries.
- g. Consults with personnel of the Special Intelligence Staff to develop requirements for all-source current information and to initiate requests for special materials.
- h. Prepares, in conjunction with the Soviet Staff, all-source current intelligence indicators relating to the assigned countries.

SECRET

Approved For Release 2000/04/19 : CIA-RDP79B01737A001100010001-8

STATEMENT OF MISSION AND FUNCTIONS

OFFICE OF CURRENT INTELLIGENCE

REGIONAL STAFF

FAR EAST DIVISION

I. MISSION

The Far East Division, under direction of the Chief, Regional Staff, will produce, after necessary coordination with other CIA components, all-source current intelligence reports and items for OCI publications concerning North and South Korea, Japan, Communist China, Nationalist China, the Philippines, Indonesia, Australia, New Zealand, Burma, Thailand, Indochina, Malaya, Pacific Ocean Islands, and other specified countries, and will provide briefing and other current intelligence support for other CIA components.

II. FUNCTIONS

With regard to the above-named countries and areas:

- a. Analyzes all-source current information and prepares evaluations and comments concerning developments, activities and trends of current importance or significance, for inclusion in regular and special OCI publications.
- b. Prepares for the Director of Central Intelligence, his deputies and other CIA officials and personnel, special reports, briefs and analyses of all-source current intelligence pertaining to the area, and provides continuing assistance for other CIA components in matters relating to the area.
- c. Serves, through the division chief, as a permanent member of the Publications Board to coordinate production activities and to establish current intelligence publication policies and standards.
- d. In consultation with the Presentations Division, prepares special detailed briefing material and presents current intelligence briefings for OCI, CIA and other governmental officials.

Approved For Release 2000/04/19 : CIA-RDP79B01737A001100010001-8

SECRET

SECRET

Approved For Release 2000/04/19 : CIA-RDP79B01737A001100010001-8
Far East Division (2)

- e. In consultation with the Special Intelligence Staff, develops requirements for all-source current information and initiates requests for special materials.
- f. Prepares all-source current intelligence indicators, for use of the Indications Center, in coordination with the Soviet Staff.
- g. Conducts continuing liaison with other CIA, IAC and USCIB components in order to obtain detailed data and analyses concerning specialized areas or areas of mutual responsibility and in order to develop consolidated evaluations of all-source current information.

Approved For Release 2000/04/19 : CIA-RDP79B01737A001100010001-8

SECRET

STATEMENT OF MISSION AND FUNCTIONS

OFFICE OF CURRENT INTELLIGENCE

REGIONAL STAFF

FAR EAST DIVISION

SOUTHEAST ASIA BRANCH

I. MISSION

The Southeast Asia Branch will prepare all-source current intelligence reports and items for OCI publications as related to Indochina (Cambodia, Laos, Vietnam), Burma, Thailand, Malaya, Singapore, North Borneo, Brunei, Sarawak, Indonesia, Portuguese Timor, New Zealand, Australia, the Philippines, Netherlands New Guinea and Pacific Ocean islands (other than U.S. or Japanese controlled), and will provide briefing and other current intelligence support for other CIA components.

II. FUNCTIONS

With regard to the above-named countries and areas:

- a. Analyzes all-source current information and prepares evaluations and comments regarding items of current importance or significance.
- b. Coordinates closely with other CIA components in order to obtain detailed information and analyses on subjects of mutual concern and in specialized areas.
- c. Prepares regular and special reports and items for inclusion in OCI publications.
- d. Prepares special material for, and presents, briefings on current intelligence matters for OCI, CIA and other governmental officials.
- e. Prepares special detailed current intelligence briefs, analyses and reports for use by CIA representatives on IAC and other committees, and upon request by other CIA components.
- f. Acts as advisor to the Publications Board in matters relating to the assigned countries.
- g. Consults with personnel of the Special Intelligence Staff to develop requirements for all-source current information and to initiate requests for special materials.
- h. Prepares, in conjunction with the Soviet staff, all-source current intelligence indicators relating to the assigned countries.

SECRET

Approved For Release 2000/04/19 : CIA-RDP79B01737A001100010001-8

STATEMENT OF MISSION AND FUNCTIONS

OFFICE OF CURRENT INTELLIGENCE

REGIONAL STAFF

FAR EAST DIVISION

CHINA BRANCH

I. MISSION

The China Branch will prepare all-source current intelligence reports and items for OCI publications as related to Communist China (including Manchuria, Inner Mongolia, Tibet, Sinkiang), Nationalist China (Formosa), Hong Kong and Macao, and will provide briefing and other current intelligence support for other CIA components.

II. FUNCTIONS

With regard to the above-named countries and areas:

- a. Analyzes all-source current information and prepares evaluations and comments regarding items of current importance or significance.
- b. Coordinates closely with other CIA components in order to obtain detailed information and analyses on subjects of mutual concern and in specialized areas.
- c. Prepares regular and special reports and items for inclusion in OCI publications.
- d. Prepares special material for, and presents, briefings on current intelligence matters for OCI, CIA and other governmental officials.
- e. Prepares special detailed current intelligence briefs, analyses and reports for use by CIA representatives on IAC and other committees, and upon request by other CIA components.
- f. Acts as advisor to the Publications Board in matters relating to the assigned countries.
- g. Consults with personnel of the Special Intelligence Staff to develop requirements for all-source current information and to initiate requests for special materials.
- h. Prepares, in conjunction with the Soviet Staff, all-source current intelligence indicators relating to the assigned countries.

Approved For Release 2000/04/19 : CIA-RDP79B01737A001100010001-8

SECRET

STATEMENT OF MISSION AND FUNCTIONS

OFFICE OF CURRENT INTELLIGENCE

REGIONAL STAFF

FAR EAST DIVISION

JAPAN-KOREA BRANCH

I. MISSION

The Japan-Korea Branch will prepare all-source current intelligence reports and items for OCI publications as related to Japan, North Korea and South Korea, and will provide briefing and other current intelligence support for other CIA components.

II. FUNCTIONS

With regard to the above-named countries:

- a. Analyzes all-source current information and prepares evaluations and comments regarding items of current importance or significance.
- b. Coordinates closely with other CIA components in order to obtain detailed information and analyses on subjects of mutual concern and in specialized areas.
- c. Prepares regular and special reports and items for inclusion in OCI publications.
- d. Prepares special material for, and presents, briefings on current intelligence matters for OCI, CIA and other governmental officials.
- e. Prepares special detailed current intelligence briefs, analyses and reports for use by CIA representatives on IAC and other committees, and upon request by other CIA components.
- f. Acts as advisor to the Publications Board in matters relating to the assigned countries.
- g. Consults with personnel of the Special Intelligence Staff to develop requirements for all-source current information and to initiate requests for special materials.
- h. Prepares, in conjunction with the Soviet Staff, all-source current intelligence indicators relating to the assigned countries.

TAB

Approved For Release 2000/04/19 : CIA-RDP79B01737A001100010001-8

B

Approved For Release 2000/04/19 : CIA-RDP79B01737A001100010001-8

SECRET

Grd 5:OCI-2813

Approved For Release 2000/04/19 : CIA-RDP79B01737A001100010001-8
OFFICE OF CURRENT INTELLIGENCE 8 December 1954

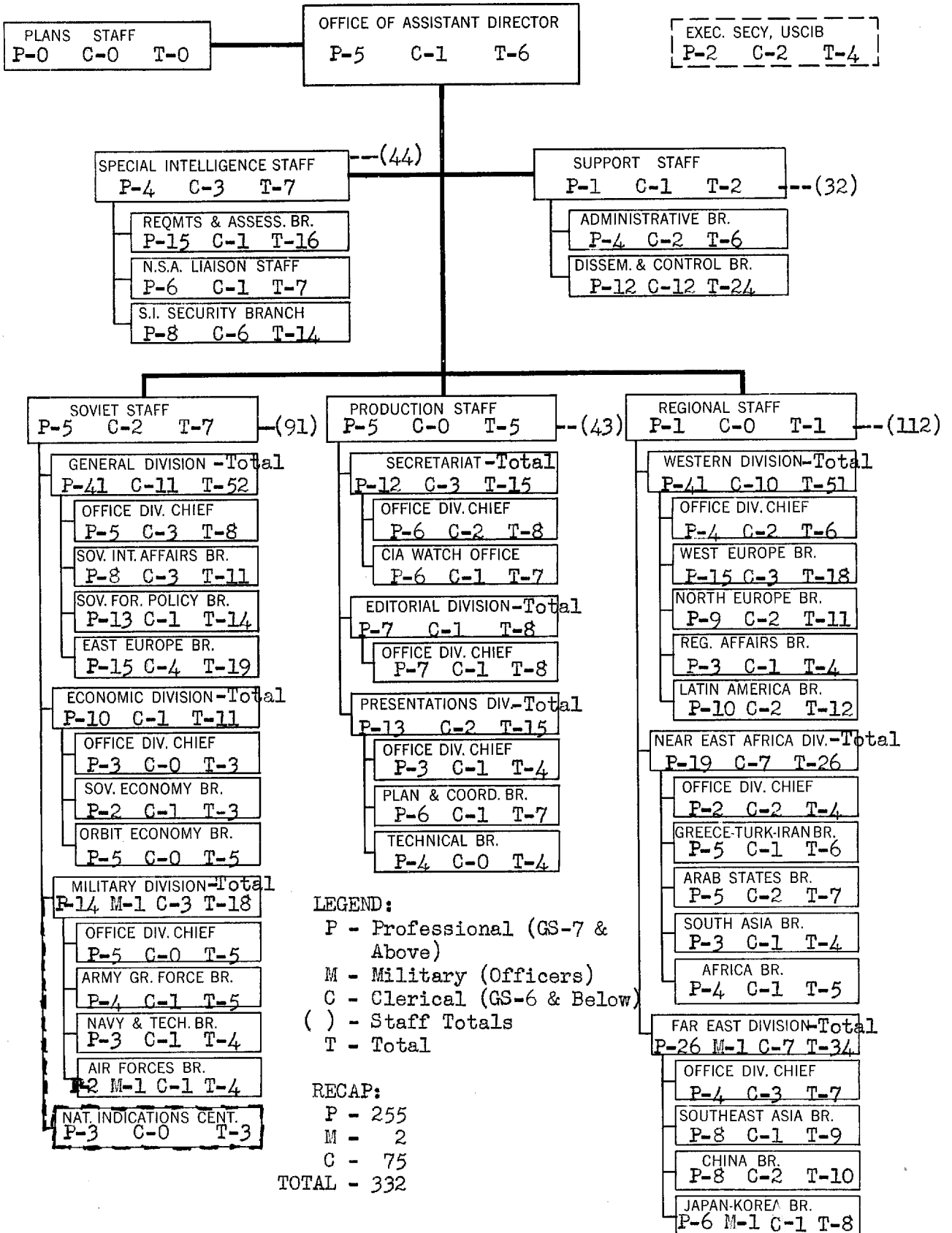

LEGEND:
 P - Professional (GS-7 & Above)
 M - Military (Officers)
 C - Clerical (GS-6 & Below)
 () - Staff Totals
 T - Total

RECAP:
 P - 255
 M - 2
 C - 75
 TOTAL - 332

TAB

Approved For Release 2000/04/19 : CIA-RDP79B01737A001100010001-8

C

Approved For Release 2000/04/19 : CIA-RDP79B01737A001100010001-8

SECRET

8 December 1954

Approved For Release 2000/04/19 : CIA-RDP79B01737A001100010001-8
OFFICE OF CURRENT INTELLIGENCE

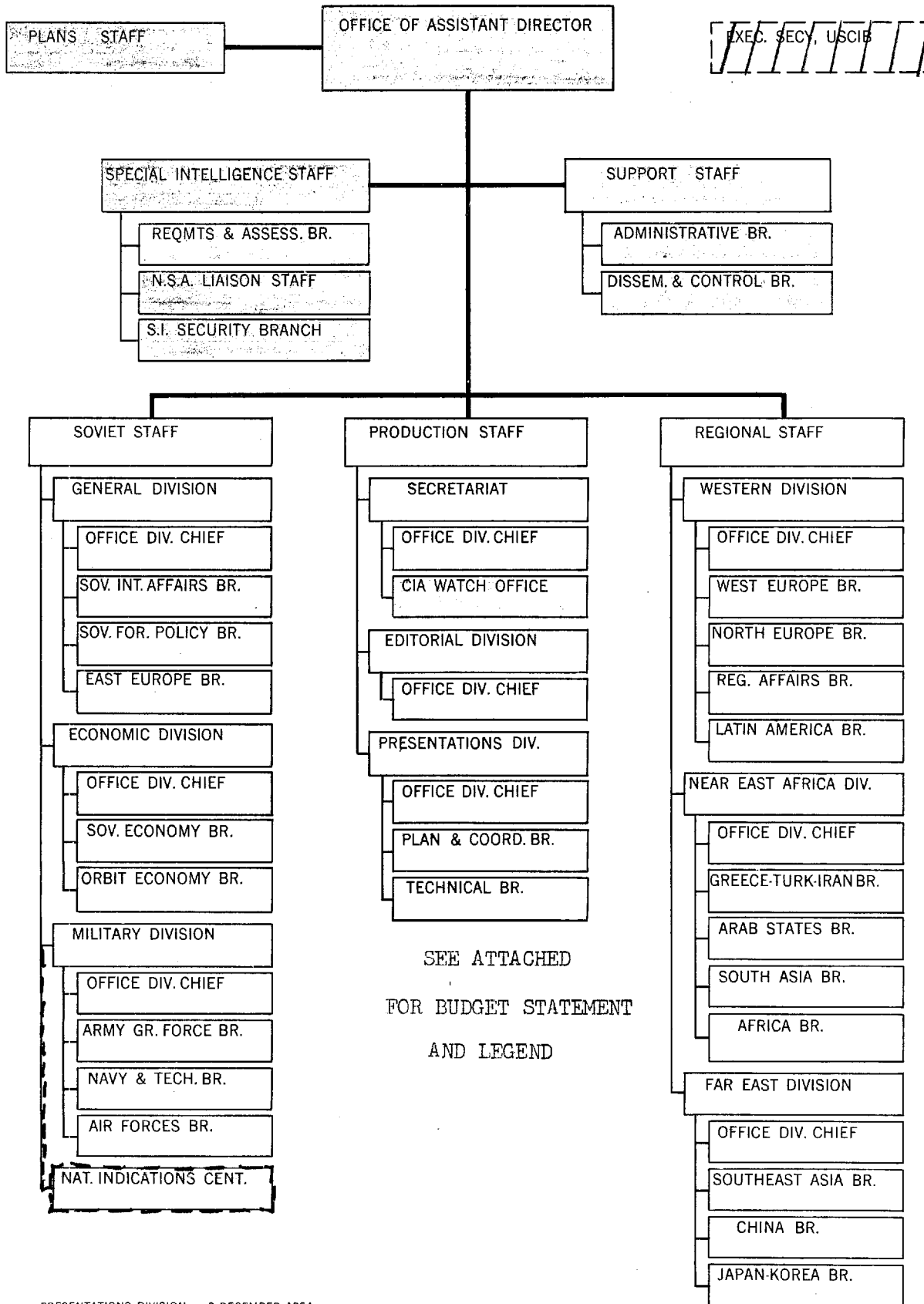







SEE ATTACHED
FOR BUDGET STATEMENT
AND LEGEND

SECRET

BUDGET STATEMENT - FY 1955

DEPARTMENTAL

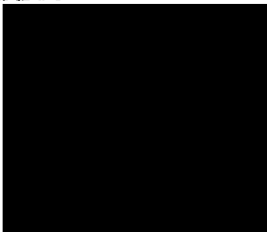
	5101 - Executive Direction & Policy		
	OI		
	All other		25X1A
	Total		
	5102 - Intelligence Support		
	OI		
	All other		25X1A
	Total		
	5103 - Intelligence Production		
	OI		25X1A
	All other		
	Total		
	5104 - USCIB Secretariat		25X1A
	OI		
	All other		
	Total		
	Total OI		
	Total All other		
	Total Departmental		

OVERSEAS

	Total OI		
	Total All other		25X1A
	Total Overseas		
	Total Departmental and Overseas		

TAB

Approved For Release 2000/04/19 : CIA-RDP79B01737A001100010001-8

D

Approved For Release 2000/04/19 : CIA-RDP79B01737A001100010001-8

8 December 1954

OFFICE OF CURRENT INTELLIGENCE PUBLICATIONS

Approved For Release 2000/04/19 : CIA-RDP79B01737A001100010001-8

<u>Name and Authority</u>	<u>Size and Frequency</u>	<u>Description of Contents</u>	<u>Production</u>
<u>Current Intelligence Bulletin</u>	Averages 6 pages Published daily Monday thru Saturday	A selection of the most important intelligence received from all sources, with evaluation and comment, prepared as a briefing for the President.	137
<u>Current Intelligence Review</u>	Averages 20 pages Published weekly on Wednesday.	An all source publication explaining trends, and problems of current concern. The Review affords a vehicle for more rounded treatment than is possible in the Bulletin.	164
<u>Current Intelligence Weekly</u>	Averages 20 pages Published on Thursdays	A secret version of the Review, for circulation to offices which do not have access to special intelligence.	490
<u>Situation Summary</u>	Averages 15 pages Published weekly on Thursday	A roundup from all sources of indications, including contributions from the Military services, bearing on Soviet Orbit capabilities and intentions.	169
<u>Current Intelligence Digest</u>	Averages 15 pages Published daily Monday thru Friday	A comprehensive digest of information received, with evaluation and comment, for distribution to analysts at the desk level. In CIA and other interested agencies. The digest is classified secret, but recipients entitled to handle more sensitive information also receive a top secret and special intelligence supplement.	534 TS SU-37
<u>Intelligence Notes</u>	Indeterminate as to size Published at irregular intervals.	Papers on any intelligence subject of current interest requiring additional information as well as elaboration and comment.	31 -

Approved For Release 2000/04/19 : CIA-RDP79B01737A001100010001-8

Approved For Release 2000/04/19 : CIA-RDP79B01737A001100010001-8

<u>Name and Authority</u>	<u>Size and Frequency</u>	<u>Description of Contents</u>	<u>Production</u>
<u>Watchpot</u>	Averages 3 pages Published daily Monday thru Saturday.	A very terse summary for the use of CIA officials of information from all sources as of one hour before the close of business. A morning edition covering the period from 1700 to 0830 includes the most significant items received during the night.	44 41
<u>Intelligence Digest for the Director.</u>	Averages 2 pages Published daily Monday thru Friday.	A very short daily summary for the DCI of items not contained in other publications read by him.	
<u>Project</u> [REDACTED] 25X1A	Averages 25 pages Published irregularly.	A series of reports analyzing the significance of developments pertaining to the status of Soviet leaders, utilizing a biographical approach. The contributors include the DD/P, biographic units of the State Department, and the National Security Agency.	150
<u>OCI Handbooks</u>	15 - 44 pages 94 books contemplated of which 53 have been distributed.	These are prepared on a country basis. They include current political, economic, military, biographic, and geographic data, with a brief review of major problems and significant trends.	157
<u>Calendar of Schedule of Forthcoming Events.</u>			
<u>Chronology of Principal Events Relative to Soviet Orbit.</u>	8 pages monthly	Information compiled for use of analysts at the desk level within CIA. The calendar is a chronological listings of significant forthcoming events. The chronology compiles the principal events that have taken place within the Orbit during the reporting period. It gives the desk level a background on which to study current situations.	69 68

<u>Name and Authority</u>	<u>Size and Frequency</u>	<u>Description of Contents</u>	<u>Production</u>
<u>Special Briefings</u>	Indeterminate as to size Published at irregular intervals.	During the presidential campaign of 1952 OCI prepared special briefings for the candidates, and after the election maintained a briefing office at the President-elect's headquarters. Portions of the NSC briefings given by the DCI are prepared by OCI on a variety of subjects suggested by current events. Other more limited briefings are prepared as the occasion arises.	Indeterminate
<u>Special Reports - Indochina Report Survey of Africa</u>	Indeterminate as to size Published at irregular intervals.	Detailed, comprehensive reports on selected subjects. The Indochina report covered all of the negotiations, plans and dates of withdrawal contained in the formulation of the truce in Indochina. The Survey of Africa reviewed the political, economic, and sociological problems facing the various governments and administrations in Africa.	Indeter- minate

(To Be Appended to Tab D of memorandum,
11 December 1954, from the Assistant
Director, Current Intelligence to
Assistant Director for Operations,
Subject: "Additional Briefing Material
for Clark Committee")

Summary of Authority for Publications Listed

Authority for CIA publication of current intelligence items from NSCID #3, paragraph b (2), which states: "The CIA and the several agencies shall produce current intelligence necessary to meet their own internal needs or external responsibilities."

Authority for OGI publication of current intelligence of critical significance is implied in CIA Regulation 50-190 "CIA Watch - Critical Information" which defines critical information and assigns responsibility to the Assistant Director for Current Intelligence for maintaining a continuous CIA Watch and for "making appropriate arrangements with the Office of the Director for officials to be contacted . . . in connection with information of the type governed by paragraph 6 of NSCID #1 and other information believed to be of sufficient importance to warrant the Director's attention." The definition of critical information includes information indicating that "conditions have arisen which may rapidly develop into an enlargement of a national emergency, endanger national security, or otherwise require urgent executive or military action."

CIA Regulation 51-550, paragraph 5, states that: "The categories listed below are reserved exclusively for documents being published under them:

(4) Situation Summary."

This Regulation, paragraph 5 b, further authenticates the use of publication titles:

- (3) Current Intelligence Review or Weekly
- (4) Current Intelligence Digest
- (5) Current Intelligence Bulletin

Regular Publications

1. Situation Summary

The Situation Summary was published by authority of a request of the White House for a weekly roundup of all intelligence bearing on the Korean War together with indications of Soviet Communist intentions elsewhere in the world and was first issued in July 1950. This obligation was assumed and continued by OGI at the request of the Director, General Smith.

2. Daily Publication

A current intelligence presidential daily was authorized by direction of the White House and was published by OGI as the "Daily Summary." When OGI was formed, the Director assigned responsibility for this to OGI, and requested that it present a comprehensive roundup of current intelligence. The name was changed to the "Current Intelligence Digest," with the edition going to the White House carrying only selected items being called "The Current Intelligence Bulletin."

3. Weekly Issues

The authority for the Weekly stems from the request of the Executive Secretary, NSC, for a weekly to supplement the daily production with a more comprehensive treatment of trends.

Special Purpose Publications

All special purpose publications were authorized by individual requests of the Office of the Director, or of the Deputy Director, Intelligence.

OFFICE OF CURRENT INTELLIGENCE

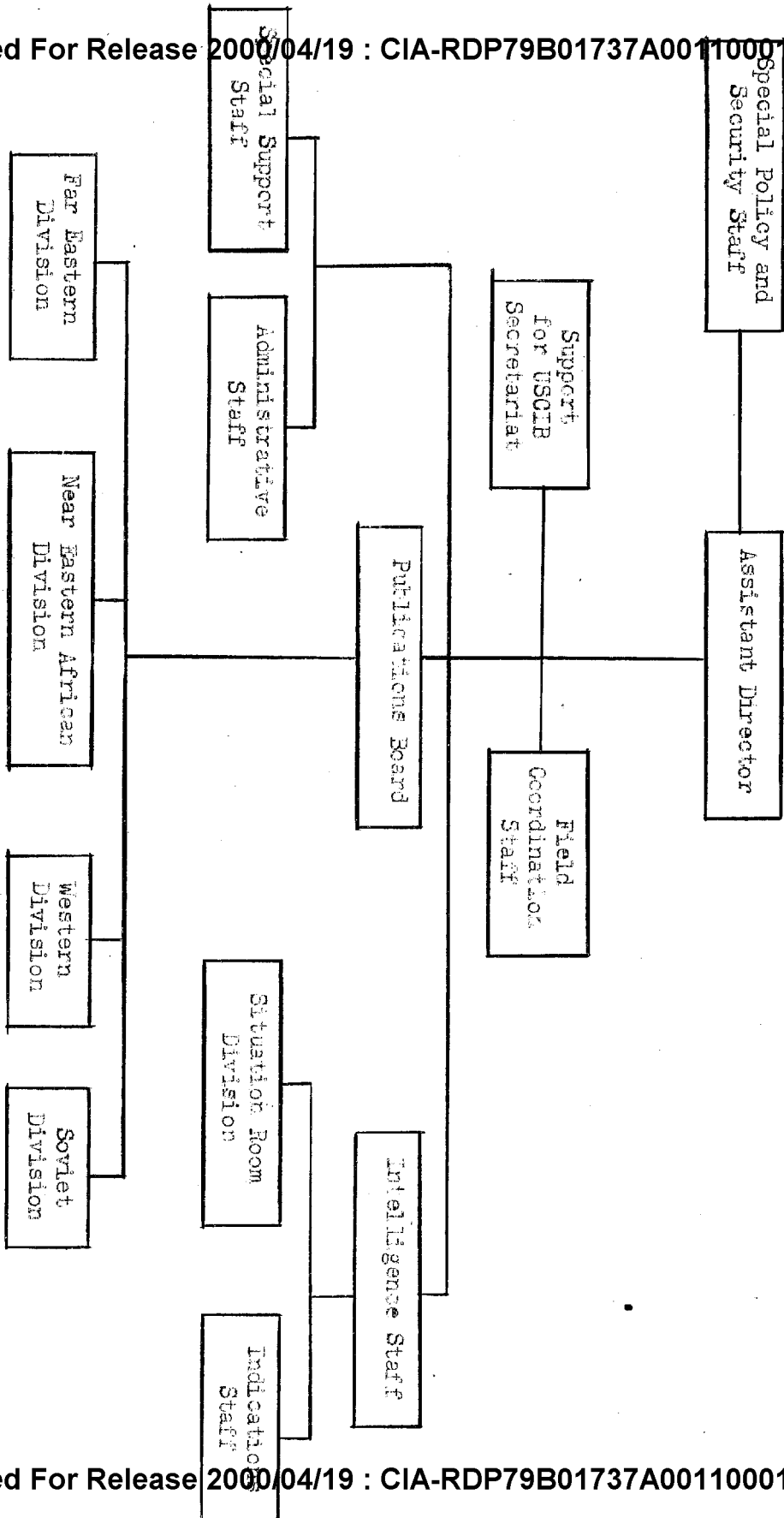

15 September 1953

SECRET
Security Information

E-7-1

SECRET
Security Information

OFFICE OF CURRENT INTELLIGENCE

FUNCTIONS AND ACTIVITIES:

The Office of Current Intelligence is charged with the responsibility for producing current intelligence on an all-source basis for the secure handling of certain special information available only to this Office, and for rendering current intelligence support to the Director of Central Intelligence and his Senior Representative abroad, to the National Security Council, the President and other high-level recipients. The Office is also responsible for maintaining and supporting the USCIB Secretariat and the Field Coordination Staff serving the Deputy Director (Intelligence).

In matters relating to special intelligence, OGI has responsibility for negotiating procurement, insuring security, arranging maximum exploitation and use, and carrying out interdepartmental and international liaison. Five special intelligence centers in CIA are controlled by this Office, in each of which are delegated or detailed elements of other CIA offices whose needs extend to the exploitation of all-source information available in OGI. The Assistant Director, as a member of USCIB, renders staff assistance and represents the Director of Central Intelligence, who is Chairman of USCIB, in policy matters relating to the handling of certain unique and sensitive material.

Assistant Director

The Assistant Director of Current Intelligence is responsible for the supervision and administration of the Office of Current Intelligence, including, primarily production of all-source current intelligence, consulting as appropriate with other offices and agencies, providing an all-source situation room for the Director of Central Intelligence and other authorized officials, maintaining the Agency Duty Officer Watch and alert United States officials concerned in the event of receipt of critical information, and performing special functions as specified by the Director of Central Intelligence.

Executive Direction and Policy

Special Policy and Security Staff

The Special Policy and Security Staff represents and advises the Assistant Director in matters of liaison and interdepartmental coordination bearing on special information. It assists in planning with regard to development, exploitation, sanitization, disguise, and operational use of such special intelligence, and provides representation on committees concerned therewith. Its Security

15 September 1953

SECRET
Security Information

E-7-2

SECRET

Security Information

Branch controls physical, personnel, and operational security measures required for the protection of intelligence of the highest order of sensitivity.

Field Coordination Staff

The Field Coordination Staff of the Deputy Director (Intelligence) is charged with the responsibility for carrying out matters pertaining to the establishment, maintenance, and substantive support of DD/I overseas elements (including ONE, ORR, OCI, OSI, OCD, but excluding [REDACTED] at foreign posts agreed upon by Senior Representatives, DD/I, and DD/P.

STATSPEC

Intelligence Support

Special Support Staff

Both within the special intelligence field and as applied to collateral materials, the Special Support Staff coordinates the activities of OCI production elements and of the special center components of other Offices of CIA. It provides operational assistance in the establishment, coordination, integration, and definition of requirements. It initiates collection actions based thereon, and processes requests for materials available through other activities. It distributes or disseminates both information and intelligence issues, and controls sensitive distribution lists, and operates a special officer-courier system for sensitive materials. Substantive and statistical assessment is accomplished within this Staff in order to afford guidance to all participating activities. The CIA Watch Office for off-duty-hour facilities and alerting media is operated by this Staff.

Administrative Staff

The Administrative Staff acts for the Assistant Director in matters of personnel, career service, management, budget and finance, training, emergency planning, and logistics.

Intelligence Production

Intelligence Staff

The Intelligence Staff exercises policy direction over the processing, production, and issuance of current intelligence on an all-source basis. It makes final substantive determination and authorizes the release of current intelligence, including that which contains evaluated comment.

15 September 1953

SECRET

E-7-3

SECRET
Security Information

It exercises substantive and policy direction over the current intelligence support rendered by OCI to other CIA Offices having a need.

Indications Staff

Under the Intelligence Staff, the Indications Staff analyzes and interprets indications of foreign capabilities and intentions affecting the security of the United States. It provides representation for CIA on the IAC Watch Committee. Through continuing study of critical situations, it provides the Chief, Intelligence Staff with hypotheses to be used in rationalization and evaluation of intentions. It guides the regional divisions in the development of all-source indicators relating to their particular geographic areas.

Situation Room Division

This Division maintains, operates, and controls the Situation Room. In collaboration with specialists having competence, and in coordination with the Publications Board, it prepares graphic portrayals and produces special maps, charts, and graphs to illustrate publications, or as may be needed in support of current intelligence presentation. It contributes to, and coordinates briefings and substantive intelligence presentations to the President, White House Staff, Director of Central Intelligence, the Deputy and Assistant Directors, and other qualified officials and intelligence officers.

Publications Board

The Publications Board selects, edits, and issues evaluated current intelligence. It takes immediate action to evaluate and issue critical items after coordination with the Intelligence Staff. It coordinates and administers established production controls over the activities of divisions producing current intelligence. It is responsible for the coordination of current intelligence assistance to other components of OCI and other Offices of CIA.

Geographic Divisions

(NB: Within their respective areas of geographic competence, the functions set forth below apply equally to Soviet Division, Far Eastern Division, Near East African Division, and Western Division.)

Approved For Release 2000/04/19 : CIA-RDP79B01737A001100010001-8
15 September 1953

SECRET
Security Information

E-7-4

SECRET
Security Information

Each area division is responsible for production of all-source current intelligence from its area, supported by appropriate evaluated comment. It selects, prepares, and submits to the Publications Board items which are held to be suitable for issue as Current Intelligence. It collaborates with the Publications Staff, Publications Board, Situation Room Division, and those other activities or Offices of CIA having competence or interest. It provides qualified senior representation to the Publications Board or to the Situation Room for briefings. It initiates information or intelligence requirements for service upon collection through the Special Support Staff, and collaborates with the Publications Staff to identify indications of current intentions of foreign powers.

USCIB Secretariat

The United States Communications Intelligence Board Secretariat, consisting of administrative and clerical personnel who are paid, given office space, and provided logistic support by CIA for the Board Chairman in his capacity as Director of Central Intelligence, produces continuity of the executive, technical, and administrative affairs of the United States Communications Intelligence Board and performs such functions as are assigned by the Board.

Approved For Release 2000/04/19 : CIA-RDP79B01737A001100010001-8

15 September 1953

SECRET
Security Information

E-7-5

Approved For Release 2000/04/19 : CIA-RDP79B01737A001100010001-8

SECRET

Security Information

OFFICE OF CURRENT INTELLIGENCE

ACCOMPLISHMENTS AND OBJECTIVES:

During FY 1953 OCI broadened its current intelligence support within CIA to provide increased service to Senior Representatives abroad, and extended its external support by providing current intelligence to the Presidential candidates and, after the inauguration, to the White House Staff and, through the Director of Central Intelligence, to the President and the National Security Council on a weekly basis. The Office has increased dissemination of its five daily issues from 638 to 674, its two weekly issues to three with dissemination from 205 to 246, and has initiated the production of intelligence notes in issues as they occurred, totalling about 350 for the year, or 234,000 copies of OCI publications issued annually, not including many oral briefings on timely subjects.

In addition, OCI now provides Secretariat services for USCIB, Field Coordination Staff functions for the DD/I offices, and current intelligence support in the field [REDACTED] for the Senior Representatives.

25X1A

25X1A

OCI has strengthened its watch on critical information, both by doubling the strength of its Watch Office and by participating directly in the deliberations of the IAC Watch Committee.

The Office has handled daily, 15,000 copies of some 2,200 separate items of information from all available sources, on an around-the-clock-alert basis, producing an average of 60 items of finished intelligence for issue each day and a large residue of research information bearing on further evaluations.

During the year, research projects were initiated relative to the critical events associated with the changing situation in Soviet Russia following the death of Stalin.

The objectives for the current and budget years, in addition to maintaining as high a quality of current intelligence output as possible will be to consolidate activities with a view to improving quality of product and dependability of intelligence support rendered the planners, policy-makers, and operators of government.

The emphasis will be upon increased competence, training, and service.

15 September 1953

SECRET

Security Information

E-7-6

Approved For Release 2000/04/19 : CIA-RDP79B01737A001100010001-8

SECRET

Security Information

Special effort will be made to strengthen the approach to evaluation of intentions through indications, to the conduct of assessment of consistency and accuracy of product, and to the development of continuity in developing appreciations and rationalizations of the motivation behind the intelligence issued.

15 September 1953

SECRET

Security Information

E-7-7

Approved For Release 2000/04/19 : CIA-RDP79B01737A001100010001-8

TOP SECRET

CONDENSED MISSION & FUNCTIONS CHART OCI

Sheet 1 of 3

1954

25X1C

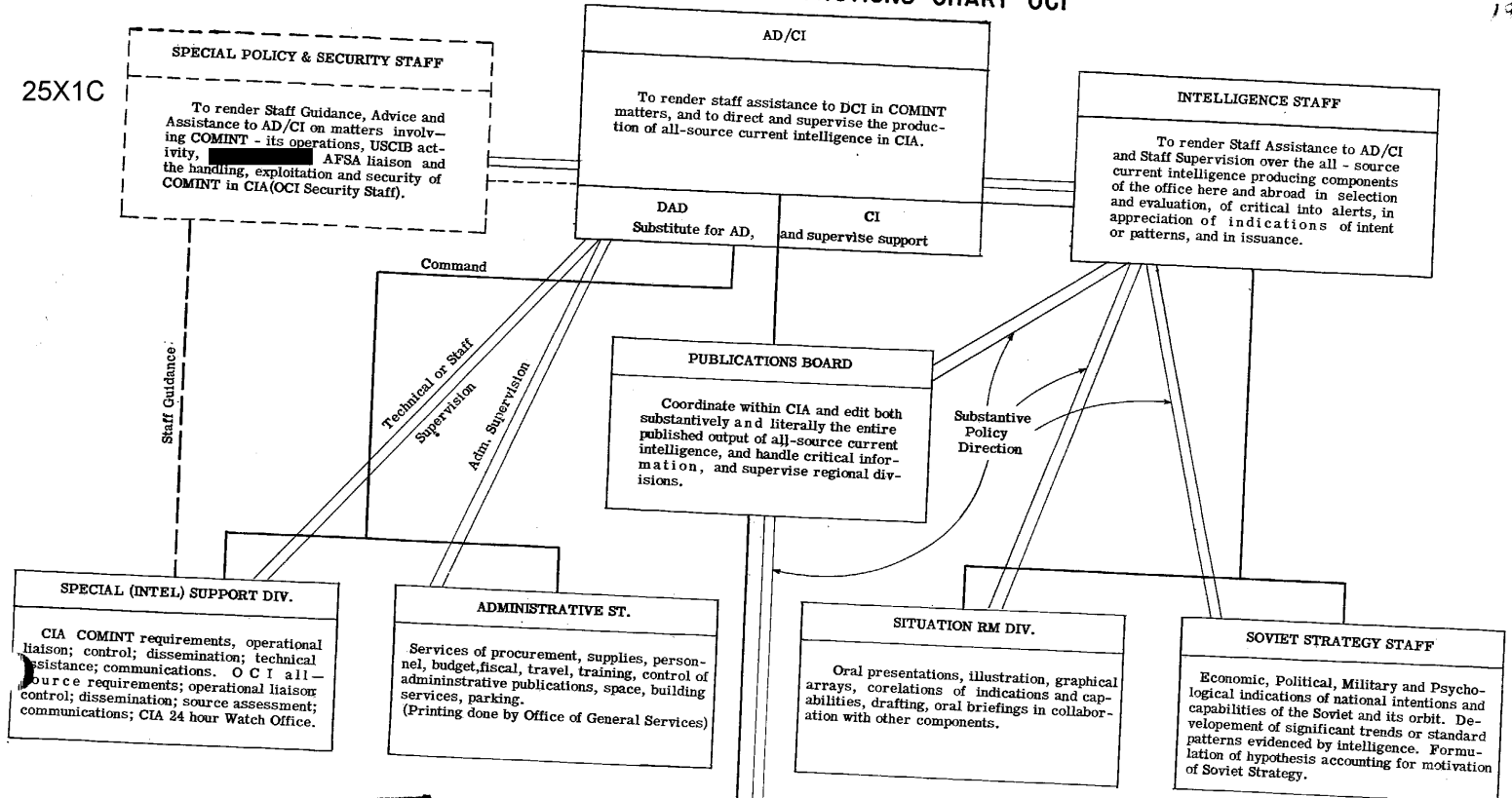

NOT TO BE REMOVED FROM SPECIAL CENTERS
TOP SECRET
 SECURITY INFORMATION

REGIONAL DIVISIONS

Producing for specifically delimited areas all-source current intelligence by:

Analysis of incoming information, and evaluation based on previous background. Prepare items for daily and weekly publication, and for irregular release, following coordination with all competent authority under time limitations imposed. Edit briefing and written dissemination of OCI in collaboration with other components.

Prepare critical items for comment and background support to DCI.

LEGEND

ACTIVITY	LEVEL	COST ACCOUNT NO.
I Direction	Policy & Management A	5101
II Production	Staff Guidance Work	5102
III Support	Staff Guidance Work	5103

25X1C

TOP SECRET

ORGANIZATION CHART OCI

LEGEND

ACTIVITY	LEVEL	COST
I Direction	Policy & Management A	5101
II Production	Staff Guidance Work	5102
III Support & Allo.	Staff Guidance Work	5103

25X1C

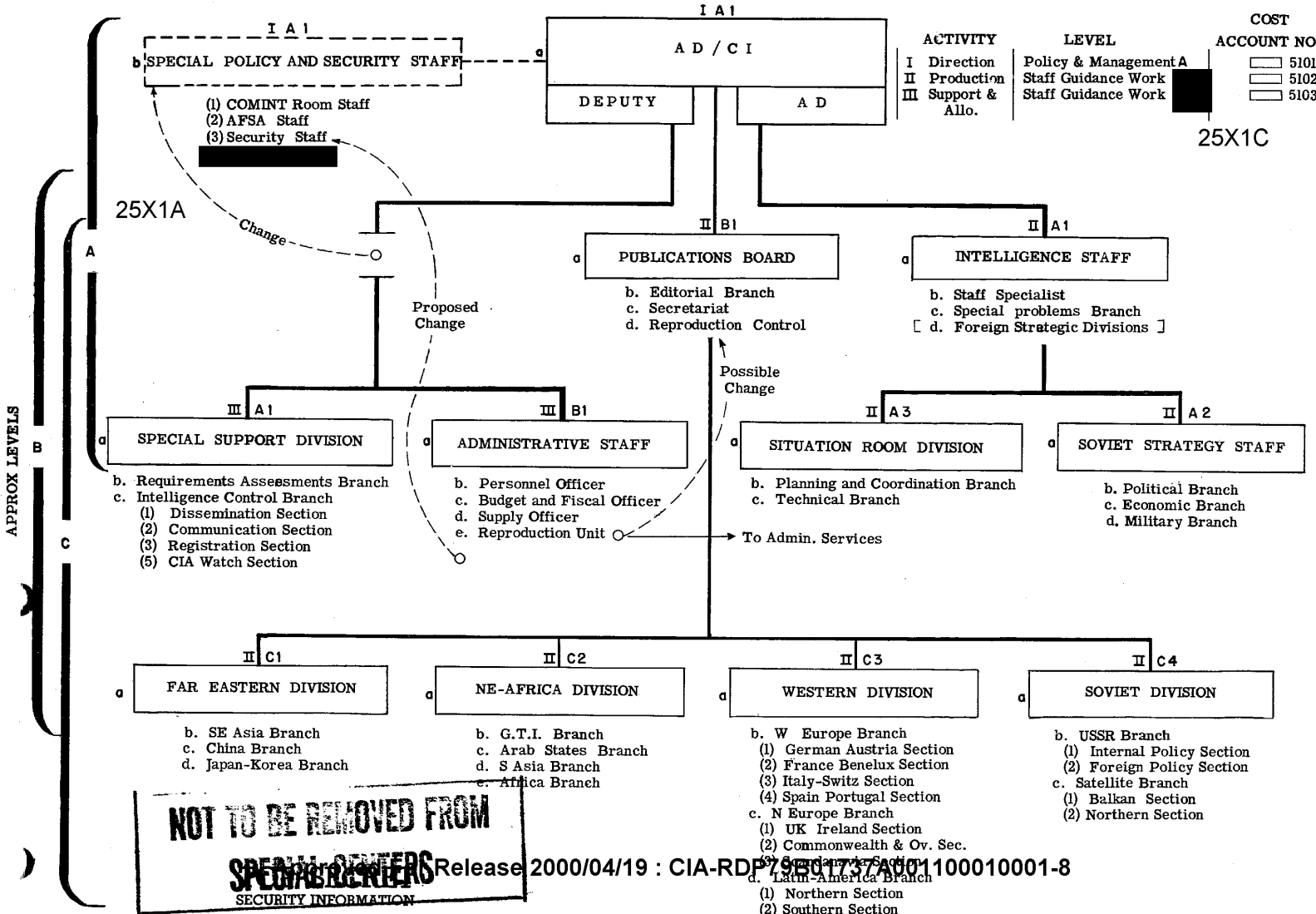

NOT TO BE REMOVED FROM

SPECIAL CENTERS SECURITY INFORMATION

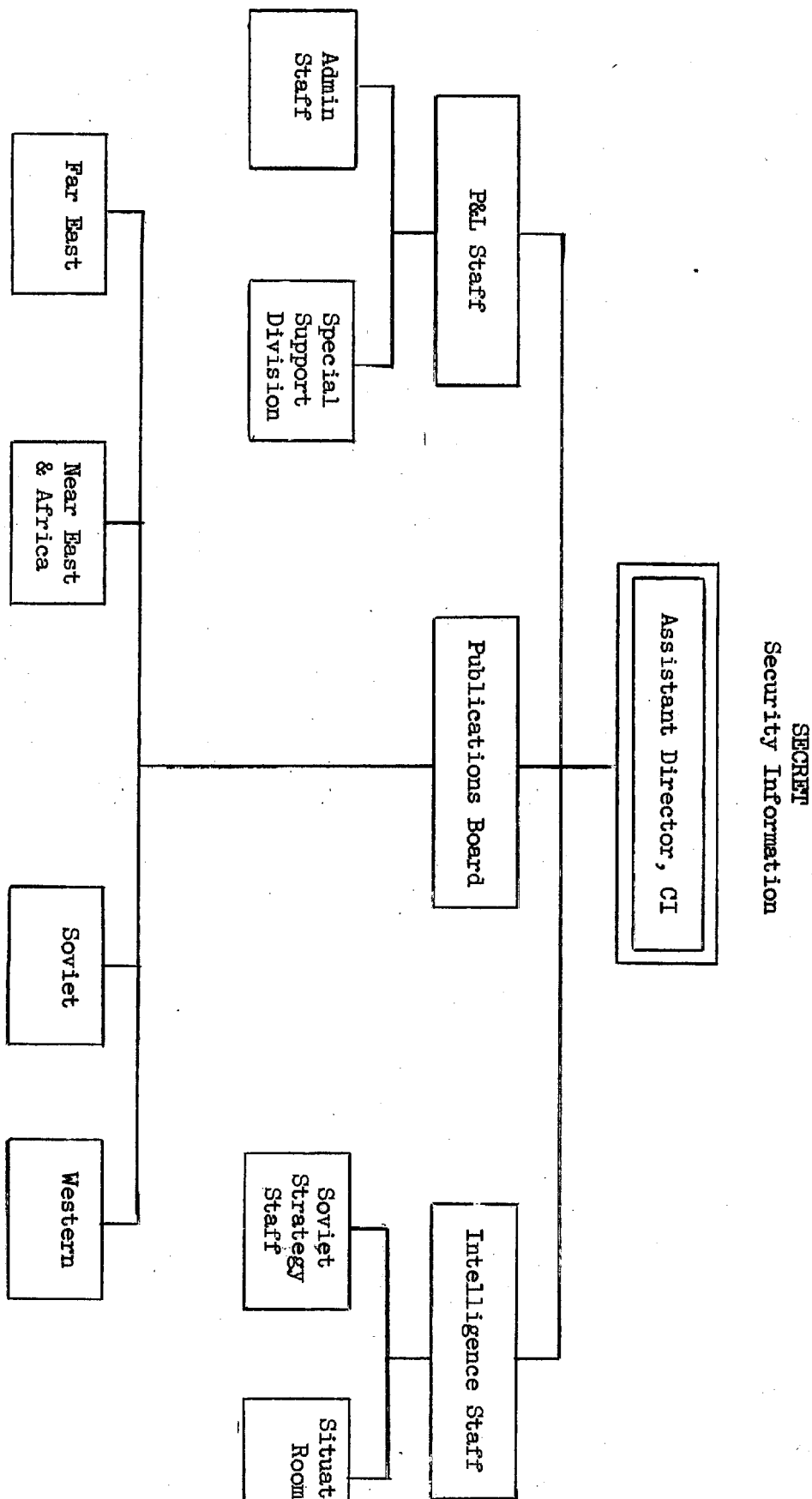

SECRET
Security Information

SECRET
Security Information

SECRET

OFFICE OF CURRENT INTELLIGENCE

STATEMENT OF CURRENT FUNCTIONS & ACTIVITIES

The Office of Current Intelligence is charged with the responsibility for producing current intelligence on an all-source basis, including certain sensitive information available only to this Office, and with disseminating such current intelligence to the National Security Council, the President, and other high-level recipients.

In matters relating to its exclusive sensitive material, OCI has responsibility for negotiating procurement, insuring security, arranging maximum exploitation and use, and carrying out interdepartmental and international liaison. A special center is operated by this Office, wherein are physically conjoined with its own activities, delegated or detailed elements of other CIA offices whose needs extend to the unique materials available through OCI. The Assistant Director renders staff assistance and represents the Director, Central Intelligence, in policy matters relating to the unique and sensitive material of cognizance.

SECRET

SECRET

OFFICE OF CURRENT INTELLIGENCE

ACCOMPLISHMENTS & OBJECTIVES

In meeting its responsibility for producing current intelligence on an all-source basis, OCI now publishes ten series of reports of various security classifications. Five of these are issued daily, three weekly, and two from time to time as required. Approximately 4,485 copies of all reports are disseminated weekly throughout the intelligence community. Additional current intelligence data are often prepared for use by the Director, Central Intelligence, in extraordinary briefings of the President and the National Security Council and in special presentations to Congressional Committees. Further, OCI has established a Situation Room where through the use of graphic media and verbal presentations periodic briefings are given by OCI to the Director, Central Intelligence, his Deputies and Assistants, and key intelligence personnel of the Government. Other CIA Offices participate in these briefings routinely.

OCI has established operations within the Armed Forces establishment for the purpose of exploitation at the source of sensitive intelligence information within its cognizance. Drawing on other Offices for personnel qualified within their respective areas of activity, OCI has provided coordination and central direction of the effort.

As the world situation shifts emphasis, it is the objective of OCI not only to keep pace by re-examining its emphasis in its publications and briefing media, but actually to remain one step ahead of developments by discovering indications of intentions and introducing presentations germane to the changing situation. To this end it is an objective of this Office to exploit fully all sources of information, utilizing to the greatest extent possible existing collection agencies. It is the plan to introduce new bodies and new operations to the minimum extent feasible for the accomplishment of this objective.

SECRET

SECRET

OFFICE OF CURRENT INTELLIGENCE

ACTIVITY DESCRIPTION

ADMINISTRATIVE STAFF:

The Administrative Staff acts in an executive capacity for the Assistant Director in matters of management, budget and finance, training, emergency planning, and logistics. It maintains a personnel office for the conduct of traditional and appropriate personnel affairs. Its security staff controls physical, personnel and operational security, whether of standard Agency significance or of special scope as dictated by sensitive areas of operation. Its reproduction facilities are operated for the sole purpose of insuring the safe reproduction of highly sensitive materials on a time-value basis. It coordinates and negotiates logistical needs and operations of whatever kind indicated.

POLICY & LIAISON STAFF:

The Policy and Liaison Staff represents and advises the Assistant Director in all matters of policy-level liaison and interdepartmental liaison bearing on OCI's special and sensitive materials. It assists in policy planning with regard to development, exploitation and operational use of such materials, and provides representation on committees and in areas where special materials are of chief concern.

SECRET

SECRET

SPECIAL SUPPORT DIVISION:

Both within the sensitive field, and as applies to collateral materials, the Special Support Division coordinates the activities of all OCI production elements and of the conjoined divisions of other Offices of CIA. It provides operational assistance in the establishment, coordination, integration, and definition of requirements. It initiates collection actions based thereon, and processes requests for materials available through other activities, avoiding duplication either of facilities or action. It distributes or disseminates both information and intelligence, and controls sensitive distribution lists, and operates a special officer courier system for sensitive materials. Substantive and statistical assessment is accomplished within this division in order to afford guidance to all participating activities. The CIA Watch Office for off-duty hour facilities and alerting media is operated by this division.

INTELLIGENCE STAFF:

The Intelligence Staff exercises substantive policy direction over the processing, production, and issuance of current intelligence on an all-source basis. It makes final determination and authorizes the publication or other presentation of all current intelligence, including that which contains evaluated comment. It exercises substantive policy direction over the current intelligence support to other CIA Offices having a need.

SOVIET STRATEGY STAFF:

Under the direct control of the Intelligence Staff, the Soviet Strategy Staff analyzes and interprets intelligence indications of foreign capabilities and intentions affecting the security of the United States. It provides total support for CIA representation of the IAC Watch Committee.

SECRET

SECRET

Through continuing study of critical situations, it provides the Chief, Intelligence Staff, with hypotheses to be used for the direction of intelligence production. It guides the regional divisions in the development of all-source indicators relating to their particular geographic areas.

PUBLICATIONS BOARD:

The Publications Board receives from production divisions of OCI materials proposed for current intelligence publications, from which it selects, edits, and publishes, or otherwise issues appropriate current intelligence. It takes immediate action to issue critical items after coordination with the Intelligence Staff. It coordinates and administers established production controls over the activities of divisions producing current intelligence. It is responsible for the coordination of current intelligence assistance to other components of OGI, and other Offices of CIA.

GEOGRAPHIC DIVISION:

(NB: Within their respective areas of geographic cognizance, the functions set forth below apply equally to Soviet Division, Eastern Division, Near East/Africa Division, and Western Division.)

Each geographic division, within its area of cognizance, is responsible for production of current intelligence based upon all-source information, and containing appropriate evaluated comment. It analyzes incoming information, and evaluates and comments upon items of current importance and significance. Selectively it prepares and submits to the Publications Board items which are held to be suitable for inclusion in Current Intelligence publications. It provides all-source current intelligence assistance to Soviet Strategy Staff, Publications Board, Situation Room Division, and those other activities or Offices of CIA which may have need therefor. It

SECRET

SECRET

provides qualified senior representation to the Publications Board or to the Situation Room for briefings. It initiates collection requirements for service upon the Special Support Division; and upon the advice and with the guidance of the Soviet Strategy Staff, it produces indicators germane to its particular area.

SITUATION ROOM DIVISION:

This division maintains, operates, and controls the use of the Situation Room. It prepares, displays, and maintains appropriate graphic portrayals of available intelligence of the highest degree of sensitivity, and produces such special maps, charts, or other graphic media as may be needed in support of current intelligence. In coordination with the Publications Board, it conducts all briefings and substantive intelligence presentations to the Director of Central Intelligence, the Deputy and Assistant Directors, and other qualified officials and intelligence officers. It operates a control desk for the selection of divisional intelligence officers to perform briefings. It provides sensitive graphic and cartographic materials for current intelligence publications. It maintains and controls a reading room for the use of qualified individuals.

SECRET

S-E-C-R-E-T

OFFICE OF CURRENT INTELLIGENCE

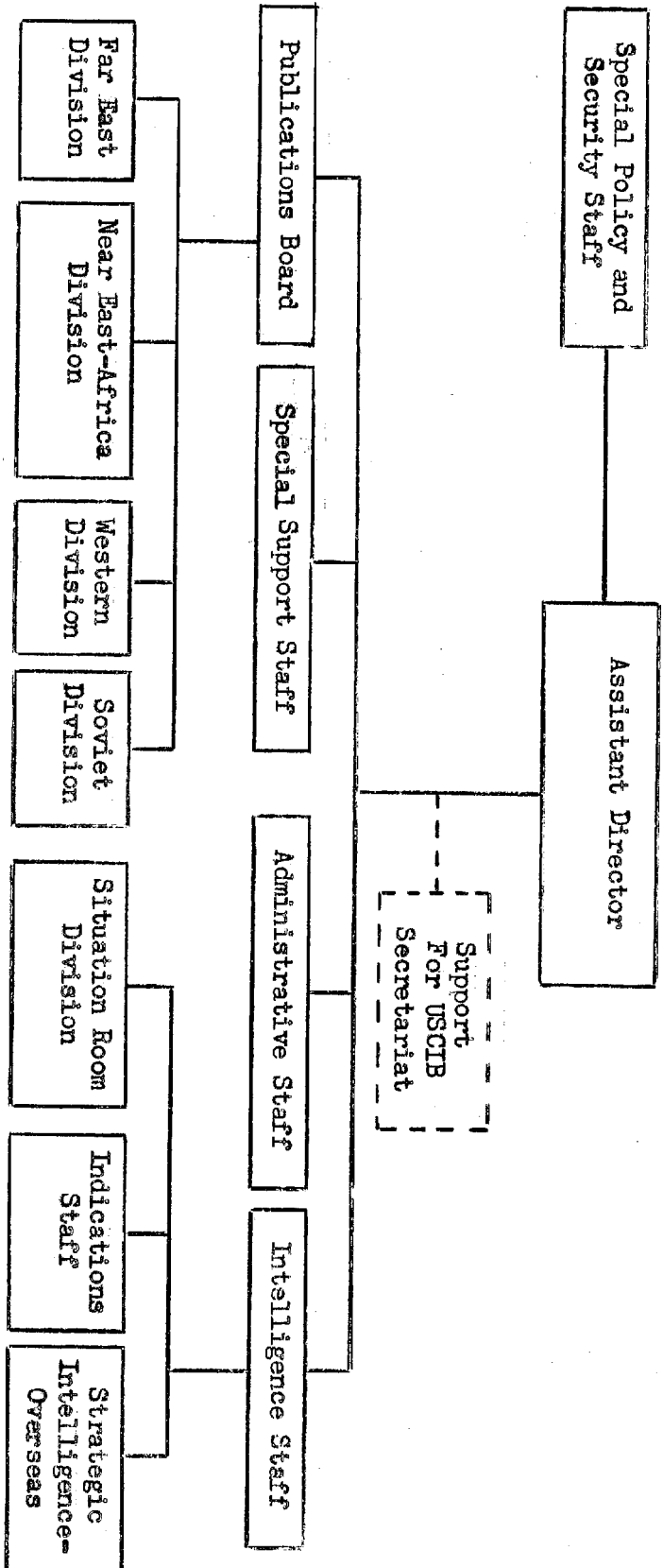

OCI - /

30 September 1955

S-E-C-R-E-T

S-R-C-R-R-T

OFFICE OF CURRENT INTELLIGENCE

FUNCTIONAL STATEMENT

The Office of Current Intelligence is charged with the responsibility for producing (all-source) current intelligence and for the procurement, exploitation and secure handling of special information. Its primary function is to render current intelligence support to the Director of Central Intelligence, his Senior Representatives abroad, the National Security Council, and the President. The Office is also responsible for maintaining and supporting the USCIB Secretariat, and contributing to the support of the National Indications Center through the IAC Watch Committee.

In matters relating to special intelligence, OCI has responsibility for negotiating procurement, insuring security, arranging maximum exploitation and use, and carrying out interdepartmental and international liaison. Five special intelligence centers or restricted areas in CIA are controlled by this Office, in each of which are stationed working elements of other CIA Offices whose needs extend to the exploitation of all-source information available in OCI. The Assistant Director, as a member of USCIB, represents CIA and gives staff assistance to the Director of Central Intelligence, who is Chairman of USCIB, the Board's primary function being formulation of operational and security policies for implementation by member agencies.

Special Policy and Security Staff

The Special Policy and Security Staff provides for CIA implementation of special intelligence policy formulated by USCIB, and represents and advises the Assistant Director in matters of liaison and interdepartmental coordination bearing on special information. It assists in planning with regard to development, exploitation, sanitization, disguise and operational use of such special intelligence, and provides representation on committees concerned therewith. Its Security Branch controls physical, personnel, and operational security measures required for the protection of intelligence of a high order of sensitivity, and advises and assists the line of supervision in exercising its responsibility for enforcement of the CIA security program in Special Centers, in staff capacity.

OCI-2

30 September 1955

S-R-C-R-R-T

~~S-E-C-R-E-T~~

OFFICE OF CURRENT INTELLIGENCE

FUNCTIONAL STATEMENT (Cont'd)

Special Support Staff

Both within the special intelligence field and as applied to collateral materials, the Special Support Staff provides operational assistance in the establishment, coordination, and levying of information requirements. It initiates collection actions and processes requests for intelligence materials available through others. It distributes, disseminates and controls information and intelligence, and operates a special courier system for sensitive materials. Statistical assessment of intelligence production is accomplished within this Staff in order to afford guidance to all participating activities. The CIA Watch Office, for providing off-duty-hour administrative facilities and for alerting upon receipt of significant or critical information, is operated by this Staff.

Administrative Staff

The Administrative Staff acts for the Assistant Director in matters of personnel, career service, management, budget and finance, training, emergency planning, and logistics.

Intelligence Staff

The Intelligence Staff exercises policy direction over the processing, production, and issuance of current intelligence on an all-source basis. It makes final substantive determination and authorizes the release of current intelligence, including that which contains evaluated comment. It exercises substantive and policy direction over the current intelligence support rendered by OCI to other CIA Offices having a need, and, in the field, staff guidance to the strategic intelligence components that provide current intelligence support to Senior Representatives at

25X1A

OCI-3

30 September 1955

S-E-C-R-E-T

S-E-C-R-E-T

OFFICE OF CURRENT INTELLIGENCE

FUNCTIONAL STATEMENT (Cont'd)

Indications Staff

Under the Intelligence Staff, the Indications Staff analyzes and interprets indications of foreign capabilities and intentions affecting the security of the United States. It provides representation for CIA on the IAC Watch Committee, and liaison and coordination with the National Indications Center. Through continuing study of critical situations, it provides the Chief, Intelligence Staff with hypotheses to be used in rationalizations and evaluation of intentions. It guides the regional divisions in the development of all-source indicators relating to their particular geographic areas. OCI also provides professional and clerical personnel who give full-time support to the activities of the National Indications Center of the IAC.

Situation Room Division

The Division maintains, operates, and controls the Situation Room. In collaboration with specialists and in coordination with the Publications Board, it prepares graphic portraels, special maps, charts, and graphs to illustrate publications, or in support of current intelligence oral presentations. It conducts, contributes to, and coordinates briefings and substantive intelligence presentations to the President, White House Staff, Director of Central Intelligence, the Deputy Assistant Directors, and others.

Publications Board

The Publications Board selects, edits, and issues evaluated current intelligence. It takes immediate action to evaluate and issue critical items after coordination with the Intelligence Staff. It coordinates and administers established production controls over the activities of divisions producing current intelligence. It is responsible for the coordination of current intelligence assistance to other components of OCI and other Offices of CIA, and for direct line supervision of area divisions of OCI.

OCZ-4

30 September 1955

S-E-C-R-E-T

S-E-C-R-E-T

OFFICE OF CURRENT INTELLIGENCE

FUNCTIONAL STATEMENT (Cont'd)

Area Divisions

(NB: Within their respective geographic areas, the functions set forth below apply equally to Soviet Division, Far East Division, Near East-Africa Division, and Western Division.)

Each area division is responsible for both spot and periodic production of all-source current intelligence from its area, supported by appropriate evaluated comment. It selects, prepares, and submits to the Publications Board items which are held to be suitable for issue as current intelligence, or which constitute indications intelligence. It collaborates with Indications Staff, Publications Board, Situation Room Division, and those other activities or Offices of CIA having competence or interest. It provides qualified senior representation to the Publications Board or to the Situation Room for briefings. It initiates information or intelligence requirements for service upon collection agencies through the Special Support Staff, and collaborates with Indications Staff to identify indications of current intentions of foreign powers.

USCIB Secretariat

OCI provides administrative and clerical personnel, office space, and logistic support for the USCIB Secretariat, in its function of providing continuity of executive, technical, and administrative service to the Board, and performs such other functions as the Board may direct.

25X1A

Strategic Intelligence - Overseas

25X1A

25X1A

Strategic Division, [redacted] (a) prepares regular briefings for [redacted] and his immediate staff and periodic briefings for [redacted] (b) provides a daily briefing cable for [redacted] (c) represents [redacted] on [redacted] (d) provides periodic cabled situation reports and spot evaluations and field estimates for the DD/I in Washington; (e) provides substantive intelligence support for [redacted]

25X1A

25X1A

25X1A

OCI-5

25X1A

30 September 1955

S-E-C-R-E-T

S-E-C-R-E-T

OFFICE OF CURRENT INTELLIGENCE

Statement of Accomplishments and Objectives

General - The on-duty strength of OCI's work force continued levelling off. Simultaneously the volume of input of raw information increased 10%, and current intelligence produced as output increased 4%. This increased quantity of work done was attended by notable improvement in its quality, as well as by expansion in its use.

Major Accomplishments and Significant Developments During Fiscal Year 1955

Non-production activities including raw information processing and other support functions (information procurement, liaison, administration, requirements, registration, dissemination, and control of information from all sources, including the most sensitive) were conducted effectively and securely--the office experiencing a new low record for frequency of security violations. Of the 711,000 separate items of information received, COMINT and State Department material made up 80%. Approximately 27% of OCI's personnel strength was utilized in performing these various facilitating services.

Intelligence Production activities utilized approximately 73% of the on-duty work force. This force, working upon an information input load 10% larger than last, produced 15,700 original pages of finished current intelligence compared with 15,000 pages for the previous year. Overtime increased approximately 100% over the previous year. Use of intelligence produced, reflected by dissemination requirements, increased by 20%. The volume of reproduction for publications increased 71%, or from 7 to 12 million pages for theyear. In addition to routine written intelligence support, the Office provided intelligence support to Senior Representatives [REDACTED] and to NSC and the White House Staff in Washington.

25X1A

C-8-2

S-E-C-R-E-T

OFFICE OF CURRENT INTELLIGENCE

Statement of Accomplishments and Objectives (Cont'd)

Objectives for Fiscal Year 1956 and the Status of the Current Program - by Activity

OCI objectives for its two major activities are:

- (1) To continue at present level the essential information processing (non-production) necessary to support intelligence production. These facilitating operations include activities of distribution, control, security, requirements, administrative support, sensitive intelligence staff support, and liaison.
- (2) To continue to improve the quality of current intelligence production, and to lend support and emphasis to the integration of indications intelligence into IAC warning of attack activities.

Program Outlook for Fiscal Year 1957

OCI's program for Fiscal Year 1957 contemplates a continuation of 1956 activities without substantial change.

2-8-3

30 September 1955

S-E-C-R-E-T