

DIFFERENTIAL ABILITIES BATTERY

FORM A

Name (Please Print) _____

Age _____ Sex _____ Applicant ()
or
Employee ()

Date _____, 19____.

This will confirm my understanding of and agreement to the following conditions of the examinations:

1. Since these examinations are considered classified, I will not discuss them either generally or in any particular with anyone.
2. I will not accept or give aid or assistance in any manner during these examinations except as authorized by the test administrator, and I understand that any such action on my part will exclude me from any further consideration for employment by the Central Intelligence Agency, or may be grounds for dismissal from the Service.
3. I further understand that the results of these examinations will not be the sole basis of decision in my case.

I hereby affirm that the signature below is my own.

(Signed) _____

FORM A

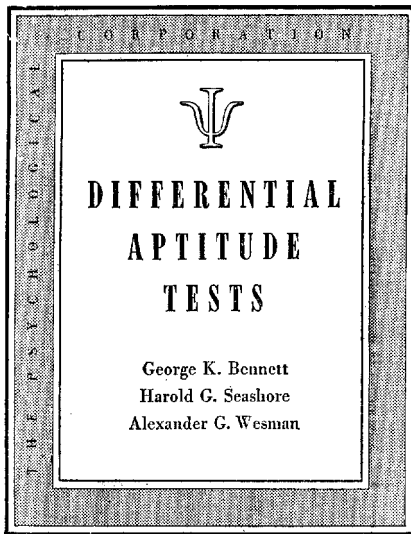

CLERICAL SPEED AND ACCURACY

FORM A

Do not open this booklet until you are told to do so.

On your SEPARATE ANSWER SHEET, print your name, address,
and other requested information in the proper spaces.

Then wait for further instructions.

DO NOT MAKE ANY MARKS IN THIS BOOKLET.

Copyright 1947
The Psychological Corporation
522 Fifth Avenue
New York 36, N. Y.

Do not make any
marks in this
booklet

SPEED AND ACCURACY

Mark your answers
on the separate
Answer Sheet

DIRECTIONS

This is a test to see how quickly and accurately you can compare letter and number combinations. On the following pages are groups of these combinations; each Test Item contains five. These same combinations appear after the number for each Test Item on the separate Answer Sheet, but they are in a different order. You will notice that in each Test Item one of the five is **underlined**. You are to look at the **one** combination which is underlined, find the **same** one after that item number on the separate Answer Sheet, and fill in the space under it.

These examples are correctly done. Note that the combination on the Answer Sheet must be exactly the same as the one in the Test Item.

TEST ITEMS

V.	<u>AB</u>	AC	AD	AE	AF
W.	aA	aB	BA	Ba	<u>Bb</u>
X.	A7	7A	B7	<u>7B</u>	AB
Y.	Aa	Ba	<u>bA</u>	BA	bB
Z.	3A	3B	<u>33</u>	B3	BB

SAMPLE OF ANSWER SHEET

	AC	AE	AF	AB	AD
V	■
W	BA	Ba	■	aA	aB

X	7B	B7	AB	7A	A7
	■
Y	Aa	■	bB	Ba	BA

Z	BB	3B	B3	3A	33
	■

If you finish the items in Part I before time is called, check your work. Do not turn to Part II until you are told to do so. Work as fast as you can.

DO NOT TURN THE PAGE UNTIL YOU ARE TOLD TO DO SO.

PART I

- | | | | | | | | | | |
|---------------|-----------|-----------|-----------|-----------|---------------|-----------|-----------|-----------|-----------|
| 1. <u>nv</u> | nx | xn | vx | xv | 26. <u>ud</u> | un | nd | nu | du |
| 2. bl | dl | ld | <u>lb</u> | bd | 27. fk | <u>lk</u> | kf | lf | kl |
| 3. ar | au | ur | ra | <u>ru</u> | 28. pq | <u>qg</u> | gp | gq | qp |
| 4. <u>wu</u> | vu | vw | wv | uw | 29. 2u | 2q | <u>qu</u> | q2 | u2 |
| 5. wm | um | mu | wu | <u>mw</u> | 30. 4i | 44 | <u>14</u> | 1i | 40 |
| 6. <u>79</u> | 76 | 67 | 69 | 97 | 31. nr | ne | en | rn | <u>re</u> |
| 7. ra | <u>na</u> | nr | rn | ar | 32. bb | <u>dd</u> | ld | db | bd |
| 8. za | mz | <u>zm</u> | az | ma | 33. RB | <u>RD</u> | DR | BR | BD |
| 9. AV | VN | NV | <u>NA</u> | VA | 34. MW | MV | VW | <u>VM</u> | WM |
| 10. OQ | <u>CQ</u> | QC | QO | OC | 35. OD | OB | BD | <u>DO</u> | BO |
| 11. <u>CU</u> | UU | UC | US | CC | 36. PR | <u>PB</u> | RB | RP | BP |
| 12. 4H | 4N | NH | N4 | <u>HN</u> | 37. Dd | Db | <u>dB</u> | bB | DD |
| 13. Rr | RP | <u>pR</u> | PP | rr | 38. EE | Ef | eF | <u>Fe</u> | <u>FF</u> |
| 14. Aa | A8 | 8a | <u>8A</u> | aA | 39. Ze | Zz | <u>ZE</u> | zE | eZ |
| 15. LT | Tt | <u>tT</u> | TI | tt | 40. <u>Zz</u> | NZ | zZ | zn | ZN |
| 16. Av | <u>Vv</u> | av | VV | AA | 41. 7c | 9b | <u>9c</u> | 9e | 7b |
| 17. 4d | 3c | <u>4a</u> | 4c | 3a | 42. 7c | <u>2b</u> | 7b | 2d | 7d |
| 18. X7 | V9 | V5 | X9 | <u>V7</u> | 43. <u>n3</u> | Sn | 3s | ns | 3n |
| 19. <u>A9</u> | 7b | 79 | 9b | b7 | 44. 20 | <u>25</u> | 02 | 05 | 52 |
| 20. <u>20</u> | 25 | 02 | 05 | 52 | 45. ec | ac | <u>ca</u> | ce | ae |
| 21. ar | ra | <u>ro</u> | or | oa | 46. 2h | h4 | 42 | <u>4h</u> | 24 |
| 22. lc | lo | ol | <u>oc</u> | co | 47. <u>av</u> | va | vo | ao | ov |
| 23. 1s | 13 | 31 | 3s | <u>s1</u> | 48. fa | <u>fr</u> | ra | rf | ar |
| 24. ma | cm | ca | <u>mc</u> | am | 49. <u>ma</u> | cm | ca | mc | am |
| 25. xv | vx | <u>vw</u> | wx | wv | 50. rc | cr | <u>co</u> | oc | or |

GO ON TO THE NEXT PAGE AND KEEP RIGHT ON WORKING.

51. <u>ch</u> ho hc oc oh	76. <u>u6</u> u4 4u 6u 46
52. se <u>rs</u> re es er	77. 3x 7x <u>78</u> 37 x7
53. <u>ar</u> au ur ra ru	78. 1s 13 31 3s <u>s1</u>
54. pq qg <u>gp</u> gq qp	79. <u>en</u> dn de ed nd
55. am na nm <u>mn</u> an	80. ni fi <u>fn</u> in nf
56. gj <u>ig</u> pg jp gp	81. 35 53 h3 <u>3h</u> 5h
57. <u>tp</u> et ep pe pt	82. bl <u>dl</u> ld lb bd
58. ra na nr rn <u>ar</u>	83. fk <u>lk</u> kf lf kl
59. bb dd ld <u>db</u> bd	84. 69 6d 9d d6 <u>d9</u>
60. 18 <u>81</u> 1a 8a a8	85. XX VX <u>VZ</u> ZV XV
61. HN HZ ZH ZN <u>NH</u>	86. <u>j8</u> a8 8a 8j ja
62. RR BR RB <u>BB</u> RP	87. 79 76 <u>67</u> 69 97
63. CU <u>UU</u> UC US CC	88. nr <u>ne</u> en rn re
64. PR PB RB <u>RP</u> BP	89. 4X 4V <u>Vx</u> V4 X4
65. CK KJ JC <u>KC</u> <u>JK</u>	90. vn vz zv nv <u>zn</u>
66. T1 1T <u>11</u> Tt TT	91. B8 R8 <u>8B</u> RB 8R
67. SX sX sx <u>Xs</u> XS	92. <u>OQ</u> CQ QC QO OC
68. LT Tt <u>tT</u> Tl tt	93. OD OB <u>BD</u> DO BO
69. Zz NZ zZ zn <u>ZN</u>	94. ZY ZX XY <u>YZ</u> YX
70. GQ Qg <u>qg</u> qg QG	95. OU OC <u>UC</u> UO CO
71. 4c <u>1a</u> 1c 4d 2d	96. Cc Oc OO cO <u>cc</u>
72. <u>S8</u> C3 S3 C8 C5	97. Aa <u>A8</u> 8a 8A aA
73. A9 <u>7b</u> 79 9b b7	98. Ze Zz <u>ZE</u> zE eZ
74. 18 81 <u>71</u> 78 17	99. BP Pb bP <u>pp</u> bB
75. b4 4d db d4 <u>bd</u>	100. <u>Cz</u> CZ Zc zC cz

STOP. DO NOT TURN THE PAGE UNTIL YOU ARE TOLD TO DO SO.

PART II

- | | | | | | | | | | |
|---------------|-----------|-----------|-----------|-----------|---------------|-----------|-----------|-----------|-----------|
| 1. YZ | VY | <u>VX</u> | XY | ZY | 26. AV | VN | NV | <u>NA</u> | VA |
| 2. b9 | c6 | 69 | 96 | <u>6c</u> | 27. YX | XX | Yy | Xy | <u>xX</u> |
| 3. ou | <u>oa</u> | ua | uo | ao | 28. EL | <u>FL</u> | FE | LF | LE |
| 4. lc | lo | ol | oc | <u>co</u> | 29. MN | NM | VN | MV | <u>NV</u> |
| 5. X7 | <u>V9</u> | V5 | X9 | V7 | 30. EE | Ef | eF | <u>Fe</u> | FF |
| 6. <u>Sc</u> | 8c | 8s | cS | c8 | 31. S8 | <u>C8</u> | 8C | 8S | S5 |
| 7. ob | bt | ot | tb | <u>bo</u> | 32. h6 | h8 | <u>86</u> | 8h | 6h |
| 8. 5e | 3d | <u>4d</u> | 2e | 2d | 33. <u>4d</u> | 3c | 4a | 4c | 3a |
| 9. rc | dc | <u>dr</u> | rd | cr | 34. Z4 | Z1 | 14 | <u>1Z</u> | 4Z |
| 10. ws | sw | <u>st</u> | tw | ts | 35. <u>Qo</u> | Qq | OQ | oq | QQ |
| 11. wm | um | mu | wu | <u>mw</u> | 36. xc | ex | <u>ec</u> | ce | xe |
| 12. pp | qq | <u>pq</u> | pg | qp | 37. <u>ar</u> | ra | ro | or | oa |
| 13. nv | nx | xn | vx | <u>xv</u> | 38. 8c | 8a | 7a | 6c | <u>7c</u> |
| 14. nu | un | <u>um</u> | mn | mu | 39. us | ue | se | <u>su</u> | eu |
| 15. zn | zz | <u>nz</u> | nn | mn | 40. <u>wo</u> | ro | rw | ow | wr |
| 16. <u>pg</u> | gy | py | yp | yg | 41. wu | vu | vw | wv | <u>uw</u> |
| 17. <u>59</u> | 9Y | 5Y | Y9 | 95 | 42. <u>er</u> | ri | ir | ie | re |
| 18. nu | <u>on</u> | ou | un | uo | 43. <u>31</u> | 23 | 32 | 13 | 21 |
| 19. ud | un | nd | <u>nu</u> | du | 44. 2u | <u>2q</u> | qu | q2 | u2 |
| 20. 41 | <u>44</u> | 14 | 11 | 40 | 45. xv | <u>vx</u> | vw | wx | wv |
| 21. Rr | RP | <u>pR</u> | PP | rr | 46. ae | et | <u>ea</u> | ta | te |
| 22. LT | IT | IL | <u>TL</u> | TI | 47. <u>VI</u> | SI | SV | VS | IV |
| 23. MW | <u>MV</u> | VW | VM | WM | 48. th | <u>he</u> | et | eh | ht |
| 24. Uu | Wu | uW | <u>WW</u> | uU | 49. za | mz | zm | <u>az</u> | ma |
| 25. 3x | xc | c3 | cx | <u>3c</u> | 50. sx | sa | ax | xs | <u>xa</u> |

GO ON TO THE NEXT PAGE AND KEEP RIGHT ON WORKING.

51. Av Vv aV VV AA
 52. Mw wW WM MM mW
 53. 4H 4N NH N4 HN
 54. Dd Db dB bB DD
 55. S8 88 S8 38 3S

56. XO OO OX OV XX
 57. S8 C8 8C 8S S5
 58. X7 V9 V5 X9 V7
 59. L7 L1 17 1L 7L
 60. RB RD DR BR BD

61. 18 81 71 78 17
 62. Vv Ww Wv wV vv
 63. Mm MN NN nn mM
 64. b9 c8 69 96 6c
 65. 4c 1a 1c 4d 2d

66. 2h h4 42 4h 24
 67. YZ VY VX XY ZX
 68. n3 Sn 3s ns 3n
 69. wo ro rw ow wr
 70. ar ra ro or oa

71. ni fi fn in nf
 72. wu vu vw wv uw
 73. th he et eh ht
 74. am na nm mn an
 75. 3x 7x 78 37 x7

76. j8 a8 8a 8j ja
 77. 59 9Y 5Y Y9 95
 78. fk lk kf lf kl
 79. ma cm ca mc am
 80. nv nx xn vx xv

81. se rs re es er
 82. 4X 4V VX V4 X4
 83. zn zz nz nn mn
 84. LT IT IL TL TI
 85. 41 44 14 11 40

86. us ue se su eu
 87. PR PB RB RP BP
 88. Rr RP pR PP rr
 89. SX sX sx Xs XS
 90. ra na nr rn ar

91. OU OC UC UO CO
 92. RB RD DR BR BD
 93. XX XO OO OX OV
 94. HN HZ ZH ZN NH
 95. Av Vv aV VV AA

96. OQ CQ QC QO OC
 97. Ze Zz ZE zE eZ
 98. GQ Qg qq qg QG
 99. Mm MN NN nn mM
 100. Qo Qq OQ oq QQ

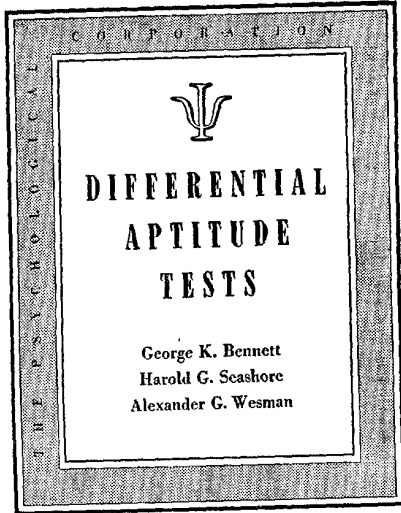

LANGUAGE USAGE

FORM A

Do not open this booklet until you are told to do so.

On your **SEPARATE ANSWER SHEET**, print your name, address, and other requested information in the proper spaces.

In the space after **Form**, print an **A**.

Then wait for further instructions.

DO NOT MAKE ANY MARKS IN THIS BOOKLET.

Copyright 1947
The Psychological Corporation
522 Fifth Avenue
New York 36, N. Y.

Do not make any marks in this booklet

LANGUAGE USAGE

Mark your answers on the separate Answer Sheet

Part I SPELLING

DIRECTIONS

This test is composed of a series of words. Some of them are correctly spelled; some are incorrectly spelled. You are to indicate whether each word is spelled right or wrong by blackening the proper space on the separate Answer Sheet. If the spelling of the word is **right**, fill in the space under **RIGHT**. If it is spelled **wrong**, fill in the space under **WRONG**.

EXAMPLES

- W. man
- X. gurl
- Y. catt
- Z. dog

SAMPLE OF ANSWER SHEET

	RIGHT	WRONG
W	<input type="checkbox"/>	<input type="checkbox"/>
	RIGHT	WRONG
X	<input type="checkbox"/>	<input type="checkbox"/>
	RIGHT	WRONG
Y	<input type="checkbox"/>	<input type="checkbox"/>
	RIGHT	WRONG
Z	<input type="checkbox"/>	<input type="checkbox"/>

If you finish Part I before time is called, check your work. Do not go on to Part II until you are told to do so.

DO NOT TURN OVER THE BOOKLET UNTIL YOU ARE TOLD TO DO SO.

- | | |
|----------------|------------------|
| 1. apointed | 26. condem |
| 2. commission | 27. absolutely |
| 3. limited | 28. cancel |
| 4. arival | 29. carreer |
| 5. comunity | 30. bullitin |
| 6. variety | 31. oposition |
| 7. agency | 32. ammunition |
| 8. distrubute | 33. survay |
| 9. hereafter | 34. energy |
| 10. conference | 35. sundery |
| 11. salery | 36. visinity |
| 12. preveous | 37. sheriff |
| 13. colusion | 38. pamflet |
| 14. director | 39. conserning |
| 15. essential | 40. securety |
| 16. cilinder | 41. necessity |
| 17. astablish | 42. expences |
| 18. quarrel | 43. testomony |
| 19. premeum | 44. avalable |
| 20. relize | 45. stating |
| 21. gratitude | 46. courtesy |
| 22. sugestion | 47. naturaly |
| 23. consinment | 48. apoligy |
| 24. revenue | 49. invilid |
| 25. inferier | 50. construction |

TURN THE PAGE AND KEEP RIGHT ON WORKING.

- | | |
|------------------|-------------------|
| 51. secretary | 76. deploma |
| 52. duplacate | 77. abundant |
| 53. gosple | 78. tedious |
| 54. traffic | 79. diligent |
| 55. captian | 80. aquainted |
| 56. sanatory | 81. resonable |
| 57. specimen | 82. customery |
| 58. accomodate | 83. muslin |
| 59. Sabbath | 84. investagation |
| 60. consious | 85. temperary |
| 61. athority | 86. indignant |
| 62. owing | 87. wretched |
| 63. emergancy | 88. unusal |
| 64. opperation | 89. defnate |
| 65. syllable | 90. garrulous |
| 66. talant | 91. allowence |
| 67. nourish | 92. appropriate |
| 68. ignorence | 93. remembrance |
| 69. behavior | 94. presense |
| 70. exceedingly | 95. caisson |
| 71. murmer | 96. appendicitis |
| 72. signiture | 97. convienient |
| 73. guardian | 98. occured |
| 74. interrupt | 99. intuition |
| 75. congradulate | 100. greatful |

STOP HERE AND WAIT FOR FURTHER INSTRUCTIONS.

Do not make any marks in this booklet

LANGUAGE USAGE

Mark your answers on the separate Answer Sheet

Part II SENTENCES

DIRECTIONS

This test consists of a series of sentences, each divided into five parts lettered A, B, C, D, and E. You are to look at each and decide which of the lettered parts have errors in grammar, punctuation or spelling. When you have decided which parts are wrong, fill in the space under those letters after that item number on the separate Answer Sheet.

EXAMPLE

Ain't we / going to the / office / next week / at all.
A B C D E

SAMPLE OF ANSWER SHEET

A	B	C	D	E

The space under A has been filled in because "ain't" is wrong; the space under E has been blackened because "at all" should be followed by a question mark. There is nothing wrong in Parts B, C and D, so the spaces under those letters have been left blank.

Some of the sentences are entirely correct. Others may have from one to five parts wrong. For each part of each sentence which you think is wrong, blacken the space under that letter on the separate Answer Sheet.

DO NOT TURN THE PAGE UNTIL YOU ARE TOLD TO DO SO.

1. Where / did you / stop at / on your trip / to Chicago.
A B C D E
2. Was it / him / who / got burned / when the boiler bursted?
A B C D E
3. The dog / laid / sleeping / after chasing John and I / with hardly no / time out.
A B C D E
4. I doubt / if Jack / has fewer / than sixteen / baseball bats.
A B C D E
5. "It is me," / said Will, / as his mother / answered / his knock.
A B C D E
6. If I were / he, / I'd be / sure / of myself.
A B C D E
7. I could / of won / if I had stood / in the game / a little longer.
A B C D E
8. If John were here / he'd sure / have done / faster work / than Fred.
A B C D E
9. I can't hardly / raise my hand / more than / three foot / above the board.
A B C D E
10. I sung / until / I was hoarse, / and then drunk / a quart of water.
A B C D E
11. Neither money / or fame / would of been / alright as payment / for such a job.
A B C D E
12. I don't understand / how anyone / could admire / a person as careless / as her.
A B C D E
13. Is it / I / whom / they / are calling?
A B C D E
14. I didn't feel / good enough / to attend / the conference / last tuesday.
A B C D E
15. I did / pretty good / in history / on last / week's quizzes.
A B C D E
16. Her father replied / "I feel / that Carol / is some better / than Mary."
A B C D E
17. The rivers raised / ten feet / after the rains, / overflowing / their banks.
A B C D E
18. I thought / you was through / doing / your work / all ready.
A B C D E
19. We O.K.'d / there proposal / that we cooperate / for our / mutual profit.
A B C D E
20. The writer / made / an illusion / to his hero's / earlier exploits.
A B C D E
21. I don't like / those kind / of peaches; / give me some / of the ripe ones.
A B C D E
22. Leave / me go / with John / and she / to the show.
A B C D E
23. He is / one of those men / who works / well / and long.
A B C D E
24. James said, / "Work, / not words, / is what / is needed."
A B C D E
25. None of the books / were / worth reading / more then / once or twice.
A B C D E

GO ON TO THE NEXT PAGE AND KEEP RIGHT ON WORKING.

26. They / nearly were / starved / before they landed / somewhere in Florida.
A B C D E
27. She / got hurt / when the dish / busted / in her hands.
A B C D E
28. I thought it / was him, / and it sure / looked like him / from this distance.
A B C D E
29. Who / do you / think / your / talking about?
A B C D E
30. The number / of volunteers / were / seldom ever / enough.
A B C D E
31. One issue of bonds / were / distributed / between / three banks.
A B C D E
32. There goes / John and Bill, / fighting / like / always.
A B C D E
33. Is it / me / who / you wanted / to see?
A B C D E
34. I don't see / as good / as Tom, / my friend / can.
A B C D E
35. Paul had / promised / to return / the book / in two weeks.
A B C D E
36. The man who / everybody likes / is one / who / they can trust.
A B C D E
37. He asked / we three, / "where / is the folks / which lived here?"
A B C D E
38. I've had / less headaches / since I / went to sleep / earlier.
A B C D E
39. The books / laid / in the grass / all day / and got wet.
A B C D E
40. You can / leave the house / in an hour / if you feel / good.
A B C D E
41. I will / be real glad / to visit you / whenever / you would prefer.
A B C D E
42. The bible / is one / of the best books / their / are for serious study.
A B C D E
43. Each of / these flowers / look best / in a different / sort of a plot.
A B C D E
44. We always turn / to who / we use to / know. the old friend / is best.
A B C D E
45. Being that / a pipe bust, / we hadn't / hardly / any water.
A B C D E
46. He had smoked / their tobacco, / drank their wine / and heard / their tales.
A B C D E
47. A man, / who beats his wife, / is considered depraved / by people / nowadays.
A B C D E
48. We seldom ever / have to / watch close / in our kind / of a job.
A B C D E
49. If it was possible, / we would of / gave him / the workers / which he wanted.
A B C D E
50. Neither Jones / nor Smith / are / the men / for that sort of a job.
A B C D E

THIS IS THE END OF THE TEST. CLOSE YOUR BOOKLET.

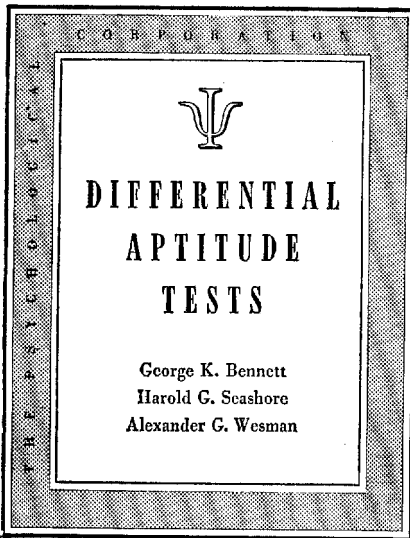

NUMERICAL ABILITY

FORM A

Do not open this booklet until you are told to do so.

On your SEPARATE ANSWER SHEET, print your name, address, and other requested information in the proper spaces.

In the space after Form, print an A.

Then wait for further instructions.

DO NOT MAKE ANY MARKS IN THIS BOOKLET.

Copyright 1947
The Psychological Corporation
522 Fifth Avenue
New York 18, N. Y.

Do not make any marks in this booklet

Mark your answers on the separate Answer Sheet

DIRECTIONS

This test consists of forty numerical problems. Next to each problem there are five answers. You are to pick out the correct answer and fill in the space under its letter on the separate Answer Sheet.

EXAMPLE X

Add $\begin{array}{r} 13 \\ 12 \\ \hline \end{array}$

A 14
B 25
C 16
D 59
E none of these

In Example X, 25 is the correct answer, so the space under the letter for 25—B—has been filled in.

EXAMPLE Y

Subtract $\begin{array}{r} 30 \\ 20 \\ \hline \end{array}$

A 15
B 26
C 16
D 8
E none of these

In Example Y, the correct answer has not been given, so the space under the letter for "none of these"—E—has been blackened.

SAMPLE OF ANSWER SHEET

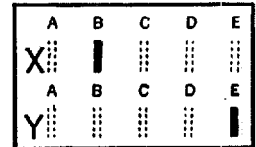

Each answer must be reduced to its simplest terms. For example, if two choices are $1\frac{1}{2}$ and $1\frac{2}{4}$, only the $1\frac{1}{2}$ is correct.

DO ALL YOUR FIGURING IN THE SPACE PROVIDED ON THE ANSWER SHEET.

1. Add

$\begin{array}{r} 393 \\ 4658 \\ 3790 \\ 67 \\ \hline \end{array}$

ANSWER
A 7908
B 8608
C 8898
D 8908
E none of these

2. Subtract

$\begin{array}{r} 5473 \\ 2987 \\ \hline \end{array}$

A 2485
B 2486
C 2496
D 3486
E none of these

3. Multiply

$\begin{array}{r} 484 \\ 25 \\ \hline \end{array}$

A 10900
B 11100
C 11900
D 11700
E none of these

4. Multiply

$\begin{array}{r} 2.04 \\ .75 \\ \hline \end{array}$

A 1.5300
B 153.0
C 1530
D 15300
E none of these

5. Multiply

$\begin{array}{r} 4.50 \\ 22 \\ \hline \end{array}$

A .99
B 98.40
C 99.00
D 9900
E none of these

6. Multiply

$\begin{array}{r} .025 \\ .025 \\ \hline \end{array}$

ANSWER
A .001375
B .00625
C .625
D 1.375
E none of these

7. Multiply

$\begin{array}{r} .016 \\ .016 \\ \hline \end{array}$

A 256
B 25.6
C .00256
D .000256
E none of these

8. Divide

$46 \overline{)69}$

A $1\frac{13}{46}$
B $1\frac{23}{46}$
C 1.5
D 15
E none of these

9. Divide

$.75 \overline{)2.25}$

A .0003
B .03
C .3
D 3
E none of these

10. Divide

$3.6 \overline{)72}$

A .02
B .2
C 2
D 20
E none of these

11. Divide

$64.7 \overline{)304.09}$

ANSWER
A .47
B 4.07
C 4.7
D 47
E none of these

12. Divide

$.04 \overline{)4.036}$

A 1.009
B 10.9
C 10.09
D 100.9
E none of these

13.

$\frac{1}{4} \div \frac{1}{8} =$

A $\frac{1}{32}$
B $\frac{1}{8}$
C $\frac{1}{2}$
D 2
E none of these

14.

$\frac{2}{7} \times \frac{3}{7} =$

A $\frac{6}{49}$
B $\frac{3}{7}$
C $\frac{2}{3}$
D $\frac{6}{7}$
E none of these

15.

$\frac{3 \times 10}{5 \times 9} =$

A $\frac{27}{50}$
B $1\frac{1}{2}$
C $\frac{30}{45}$
D $\frac{2}{3}$
E none of these

16. Add

- 4 $\frac{3}{4}$
- 9 $\frac{1}{2}$
- 13 $\frac{7}{8}$

- A 26 $\frac{11}{14}$
- B 27 $\frac{1}{8}$
- C 28 $\frac{1}{2}$
- D 28 $\frac{11}{14}$
- E none of these

17. Add

- 2 ft. 3 in.
- 28 ft. 11 $\frac{1}{2}$ in.
- 17 ft. 5 in.
- 4 $\frac{1}{2}$ in.

- A 49 ft.
- B 48 ft. 2 in.
- C 47 ft. 24 in.
- D 48 ft.
- E none of these

18. Add

- 3 lbs. 3 oz.
- 6 lbs. 7 oz.
- 7 lbs. 5 oz.
- 11 lbs. 1 oz.

- A 28 lbs. 16 oz.
- B 28 lbs.
- C 27 lbs. 16 oz.
- D 18 lbs.
- E none of these

19. Square root

$$\sqrt{169}$$

- A 13
- B 43
- C 84 $\frac{1}{2}$
- D 169
- E none of these

20. Square root

$$\sqrt{.09}$$

- A .03
- B .3
- C 3
- D 9
- E none of these

21. Square root

$$\sqrt{\frac{4}{9} \times \frac{25}{36}}$$

- A $\frac{25}{81}$
- B $\frac{25}{36}$
- C $\frac{5}{9}$
- D $2\frac{7}{9}$
- E none of these

22.

$$? = 33\frac{1}{3}\% \text{ of } 963$$

- A 32.19
- B 231
- C 321
- D 32100
- E none of these

23.

$$? = 12\frac{1}{2}\% \text{ of } 816$$

- A .12
- B 12
- C 102
- D 104
- E none of these

24.

$$? = \frac{4}{9} \text{ of } 648$$

- A 14.58
- B 72
- C 218
- D 1458
- E none of these

25.

$$15 = 75\% \text{ of } ?$$

- A .20
- B 10.25
- C 20
- D 22.5
- E none of these

26.

$$25 = ?\% \text{ of } 125$$

- A $\frac{1}{5}$
- B 5
- C 20
- D 31.25
- E none of these

27.

$$2.5 = ?\% \text{ of } 2$$

- A 5
- B 8
- C 80
- D 125
- E none of these

28.

$$\frac{?}{8} = \frac{3}{24}$$

- A $\frac{1}{8}$
- B 1
- C 3
- D 4
- E none of these

29.

$$\frac{5}{9} = \frac{55}{?}$$

- A $\frac{55}{99}$
- B 11
- C 45
- D 99
- E none of these

30.

$$\frac{11}{4} = \frac{77}{?}$$

- A $\frac{77}{28}$
- B 28
- C 44
- D 308
- E none of these

31. Cube root

$$\sqrt[3]{32 \times 2}$$

- A 4
- B 8
- C $21\frac{1}{3}$
- D 192
- E none of these

32. Cube root

$$\sqrt[3]{.000729}$$

- A .000243
- B .009
- C .027
- D .09
- E none of these

33. Cube root

$$\sqrt[3]{\frac{1}{8} \times \frac{125}{64}}$$

- A $\frac{5}{8}$
- B $\frac{375}{512}$
- C $2\frac{1}{2}$
- D $15\frac{5}{8}$
- E none of these

34.

List price = \$75.00
Discounts = $33\frac{1}{3}\%$; 2%
Net price = \$?

- A 25
- B 48.50
- C 49.50
- D 50
- E none of these

35. What one number can replace both question marks?

$$\frac{2}{?} = \frac{?}{50}$$

- A 1
- B 10
- C 25
- D 100
- E none of these

36. What one number can replace both question marks?

$$\frac{1}{?} = \frac{?}{36}$$

- A 6
- B 12
- C 35
- D 36
- E none of these

37. What one number can replace both question marks?

$$\frac{4}{?} = \frac{?}{100}$$

- A 1
- B 20
- C 25
- D 200
- E none of these

38. What one number can replace both question marks?

$$\frac{8}{?} = \frac{?}{12\frac{1}{2}}$$

- A $1\frac{1}{2}$
- B 4
- C 64
- D 100
- E none of these

39. What one number can replace both question marks?

$$\frac{6.25}{?} = \frac{?}{16}$$

- A 4
- B 10
- C 16
- D 50
- E none of these

40.

$$\frac{9+1 \times 6-3}{4+2 \times 7-6} = ?$$

- A $\frac{57}{50}$
- B $1\frac{7}{12}$
- C 1
- D $\frac{57}{36}$
- E none of these

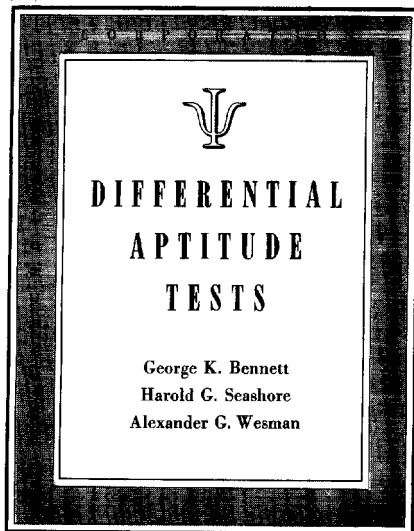

ABSTRACT REASONING

FORM A

Do not open this booklet until you are told to do so.

On your SEPARATE ANSWER SHEET, print your name, address, and other requested information in the proper spaces.

In the space after Form, print an A.

Then wait for further instructions.

DO NOT MAKE ANY MARKS IN THIS BOOKLET

Copyright 1947
The Psychological Corporation
522 Fifth Avenue
New York 18, N. Y.

Do not make
any marks in
this booklet

ABSTRACT REASONING

Mark your answers
on the separate
Answer Sheet

DIRECTIONS

In this test you will see rows of designs or figures like those on this page. Each row is a problem. You are to mark your answers on a separate Answer Sheet as shown in the samples below.

Each row consists of four figures called Problem Figures and five called Answer Figures. The four Problem Figures make a series. You are to find out which one of the Answer Figures would be the next, or the fifth one in the series.

EXAMPLE X

PROBLEM FIGURES

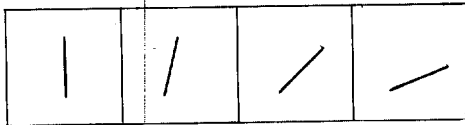

ANSWER FIGURES

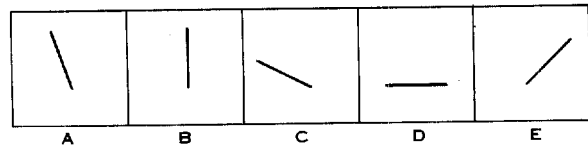

Note that the lines in the Problem Figures are falling down. In the first square the line stands straight up, and as you go from square to square the line falls more and more to the right. In the fifth square the line would be lying flat. So the answer is D, which is indicated on your Answer Sheet by filling in the little space below D, like this



EXAMPLE Y

PROBLEM FIGURES

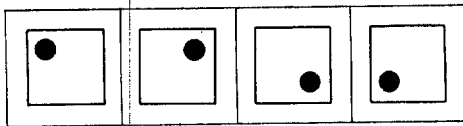

ANSWER FIGURES

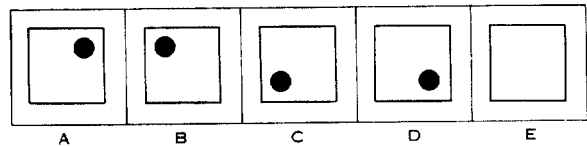

Study the position of the black dot. Note that it keeps moving around the square clockwise: upper left corner, upper right corner, lower right corner, lower left corner. In what position will it be seen next? It will come back to the upper left corner. Therefore, B is the answer, and you would mark your Answer Sheet like this



Remember—You are to select the one figure from among the Answer Figures which belongs next in the series.

DO NOT TURN OVER THE BOOKLET UNTIL YOU ARE TOLD TO DO SO.

PROBLEM FIGURES

ANSWER FIGURES

Approved For Release 1999/09/08 : CIA-RDP80-01826R001000010002-2

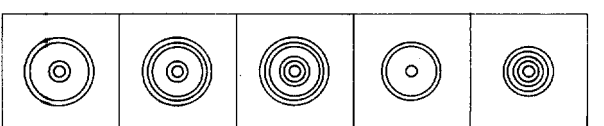
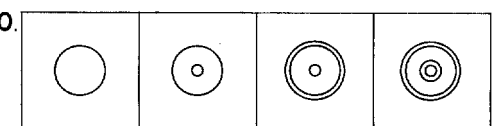
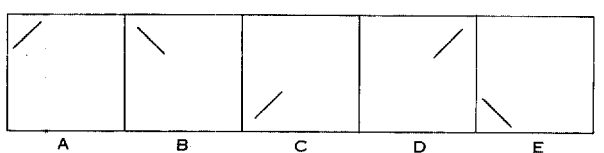
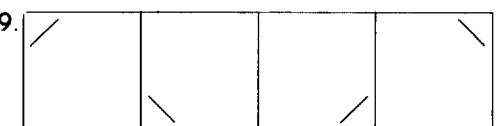
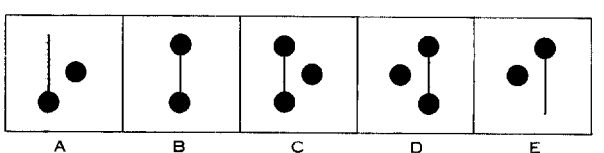
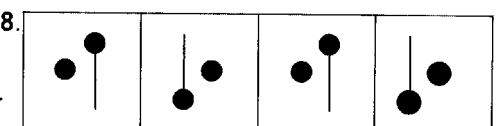
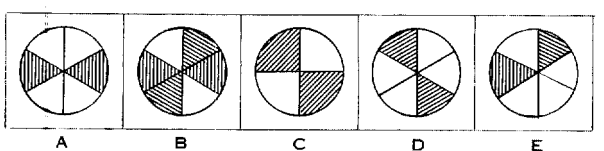
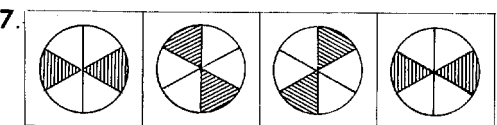
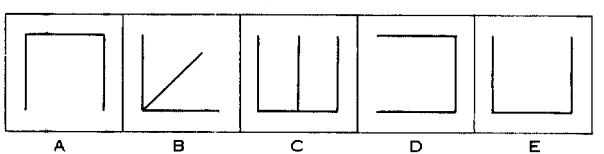
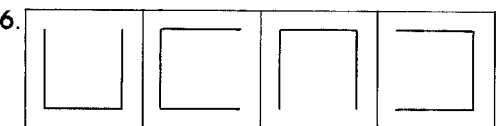
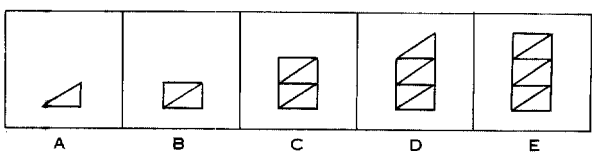
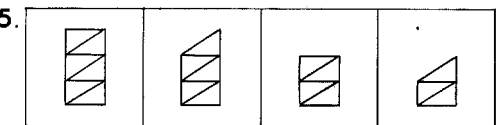
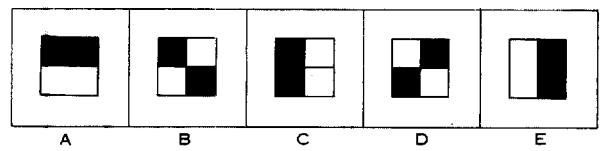
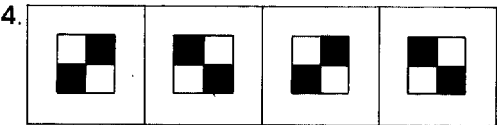
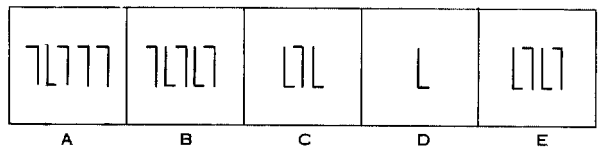
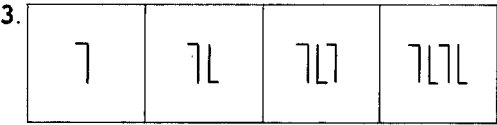
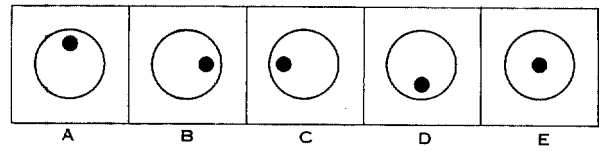
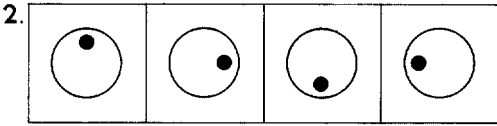
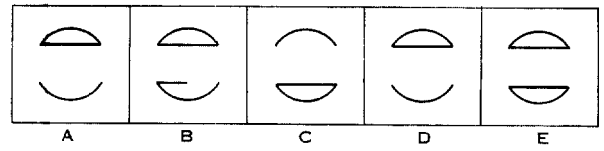
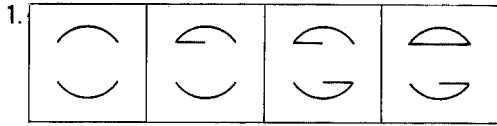

Approved For Release 1999/09/08 : CIA-RDP80-01826R001000010002-2

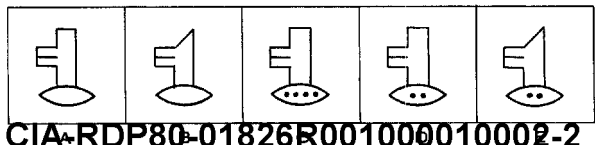
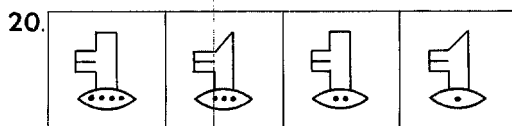
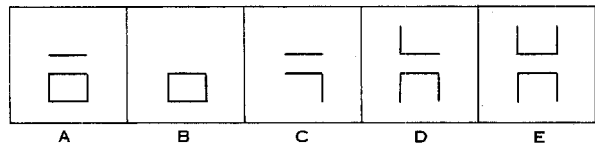
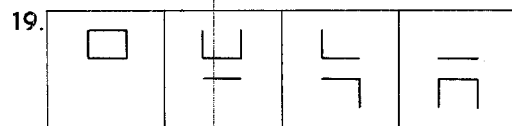
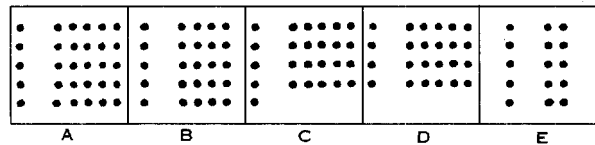
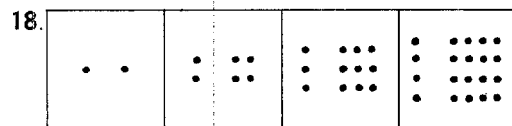
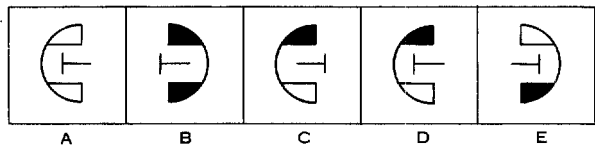
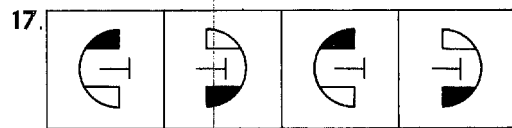
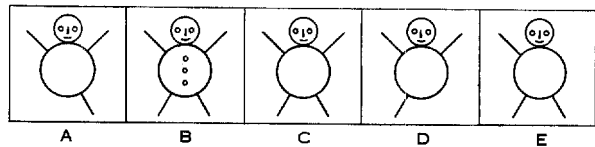
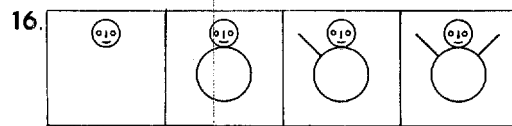
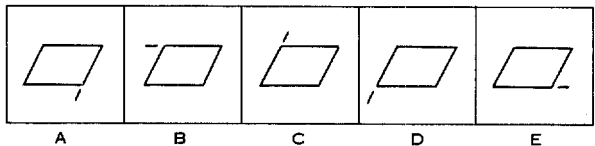
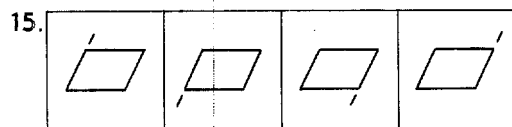
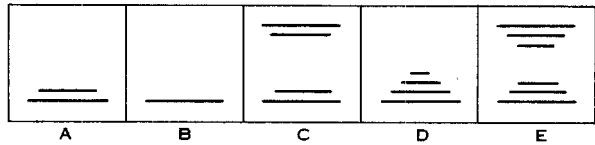
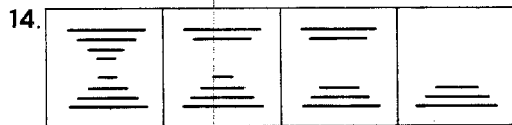
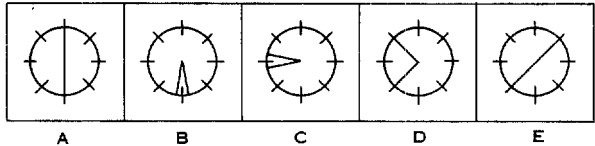
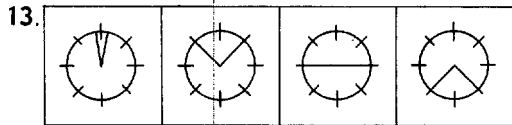
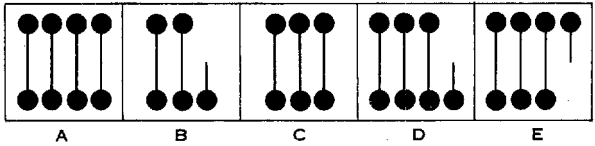
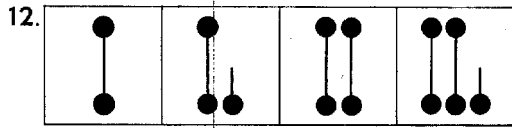
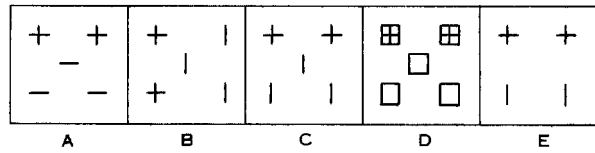
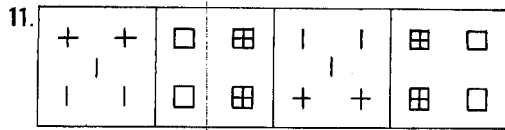

PROBLEM FIGURES

ANSWER FIGURES

Approved For Release 1999/09/08 : CIA-RDP80-01826R001000010002-2

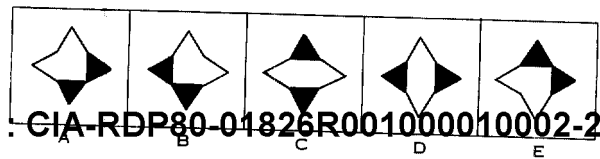
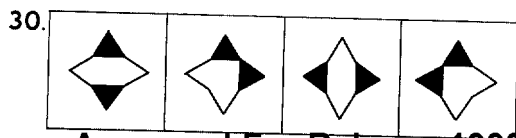
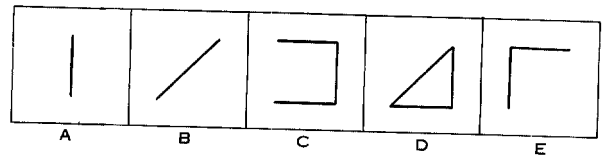
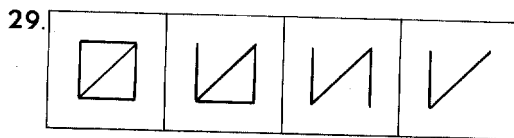
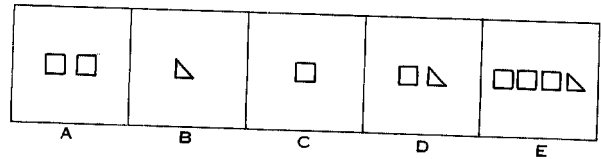
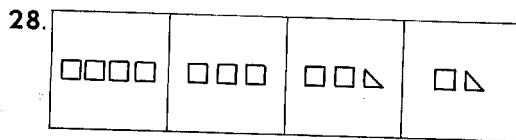
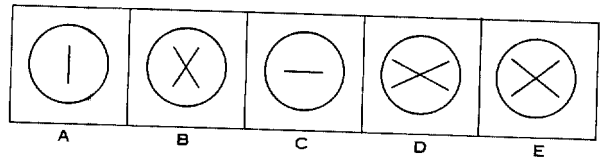
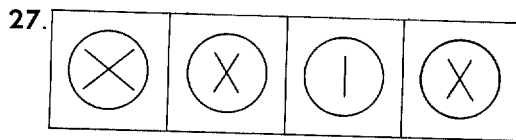
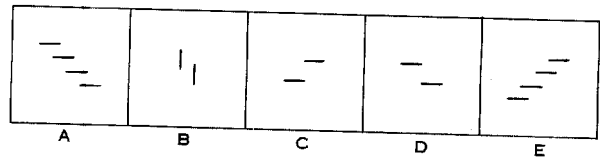
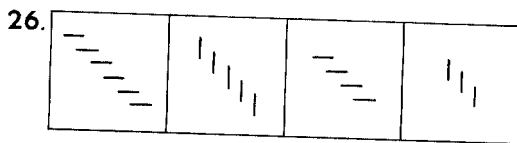
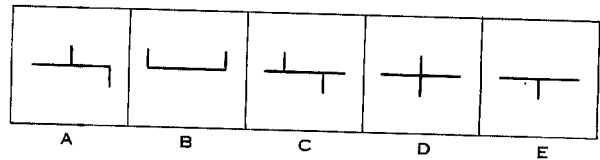
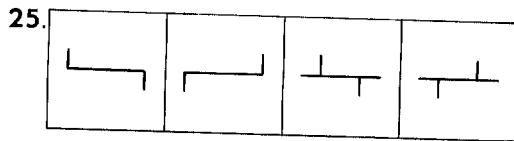
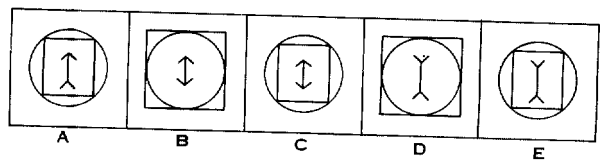
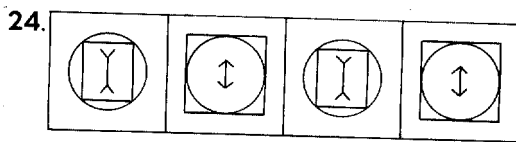
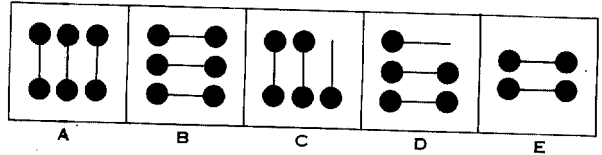
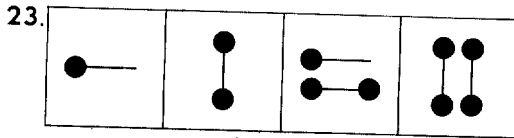
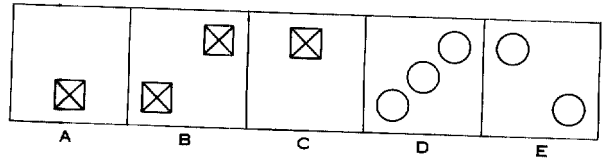
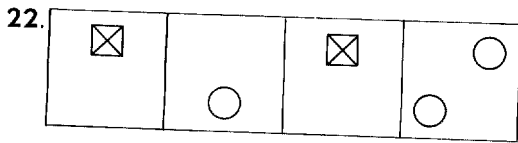
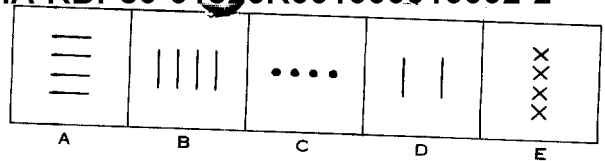
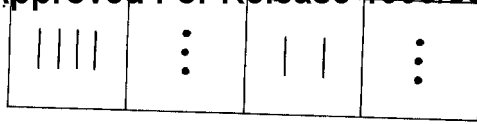

Approved For Release 1999/09/08 : CIA-RDP80-01826R001000010002-2

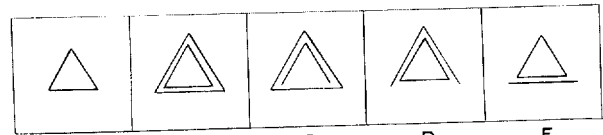
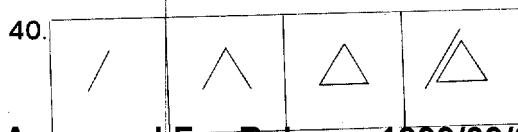
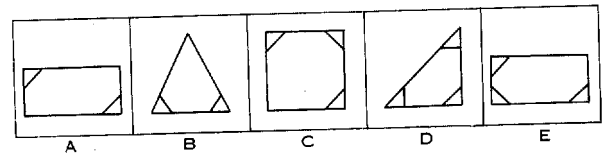
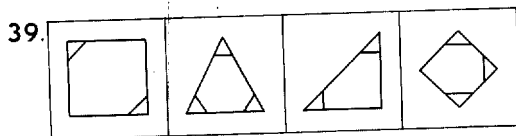
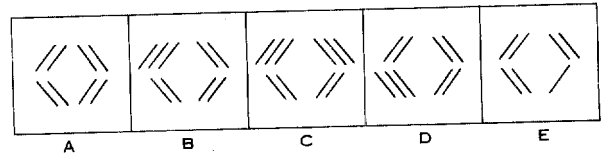
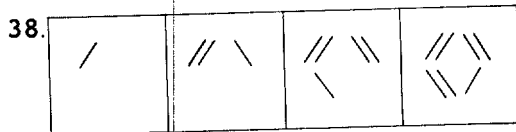
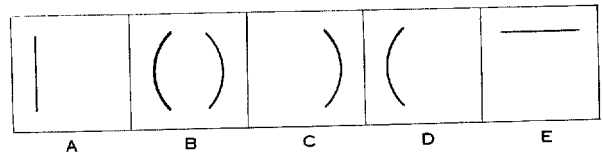
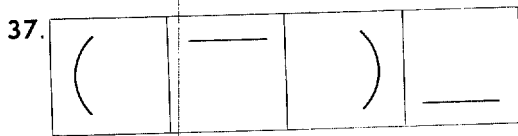
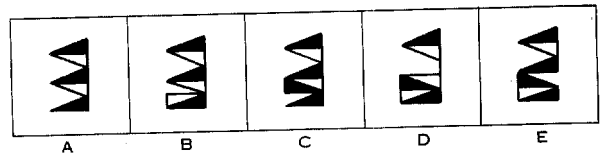
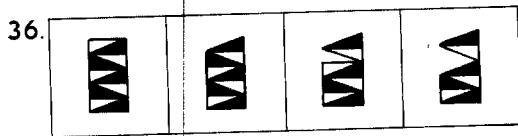
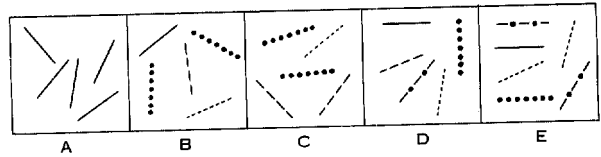
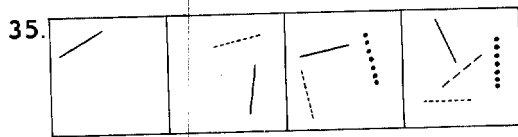
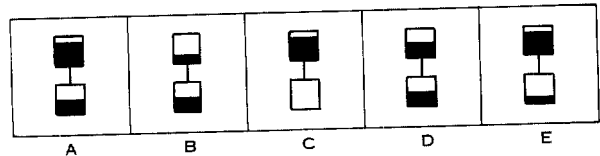
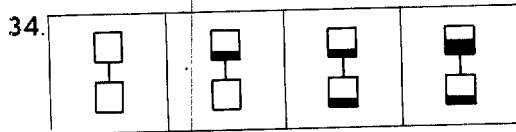
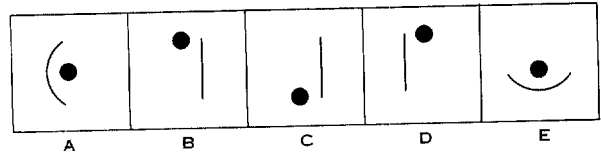
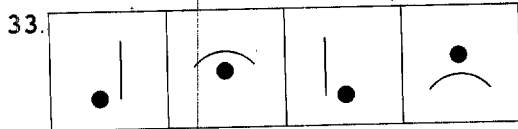
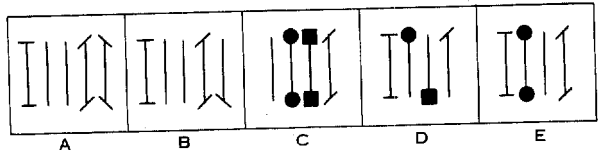
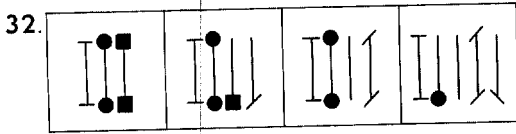
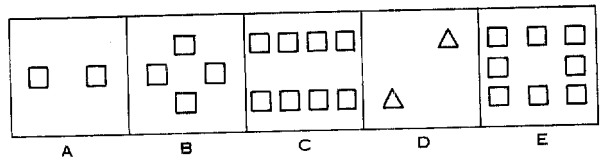
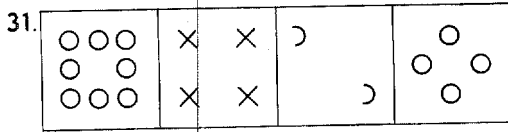

PROBLEM FIGURES

ANSWER FIGURES

Approved For Release 1999/09/08 : CIA-RDP80-01826R001000010002-2

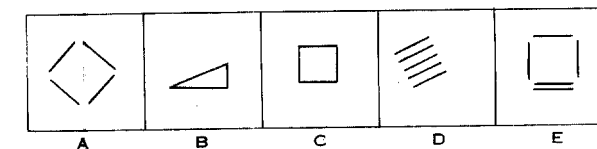
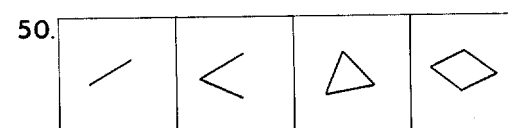
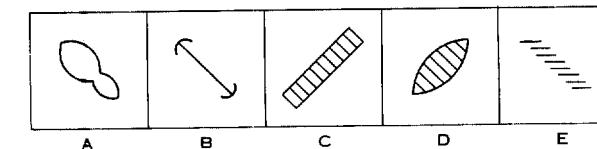
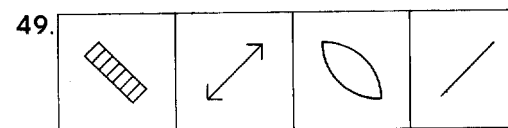
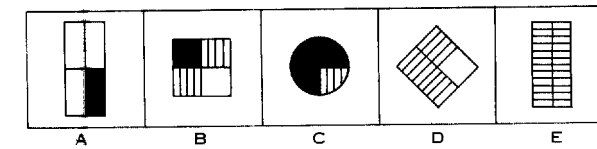
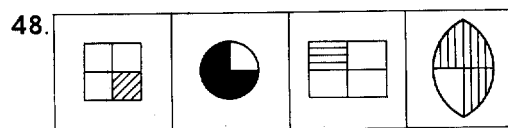
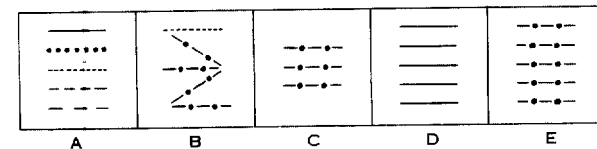
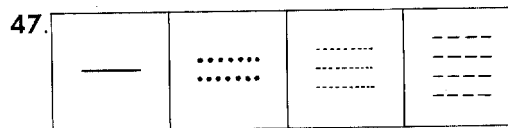
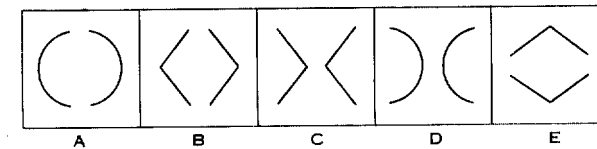
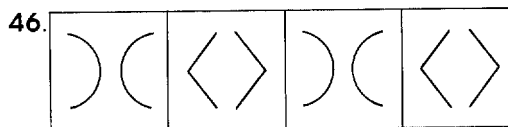
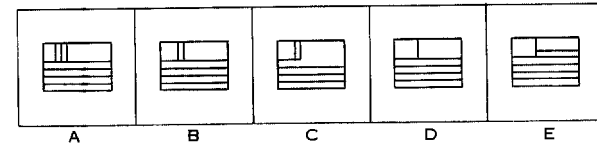
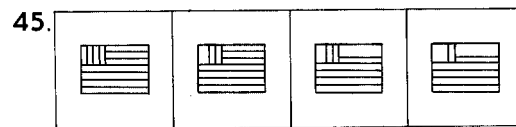
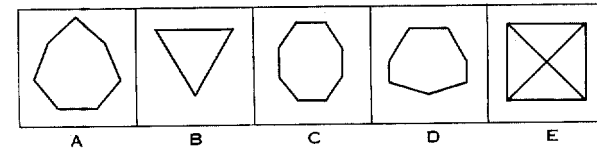
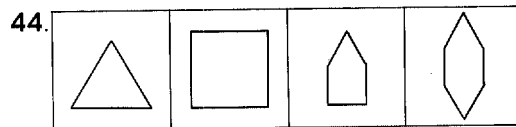
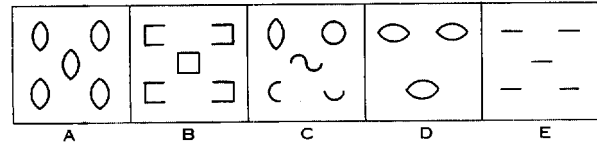
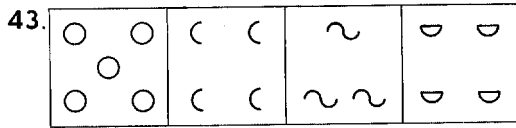
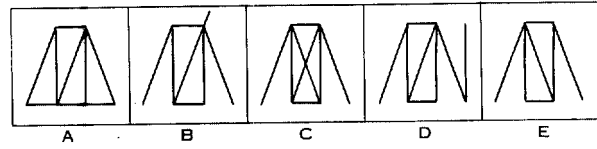
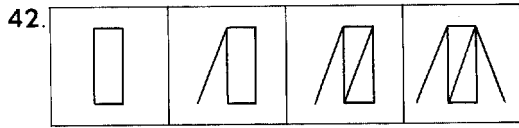
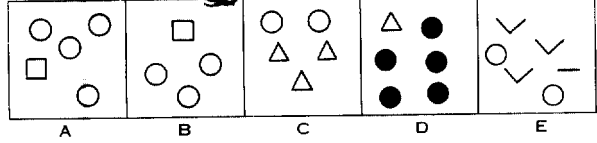
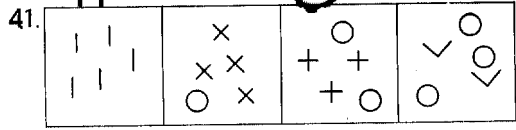

Approved For Release 1999/09/08 : CIA-RDP80-01826R001000010002-2

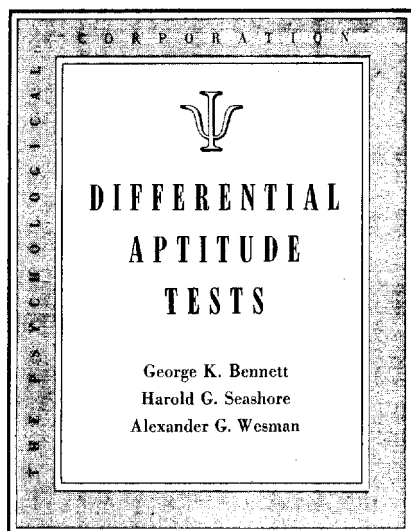

MECHANICAL REASONING

FORM A

Do not open this booklet until you are told to do so.

On your SEPARATE ANSWER SHEET, print your name, address, and other requested information in the proper spaces.

In the space after Form, print an A.

Then wait for further instructions.

DO NOT MAKE ANY MARKS IN THIS BOOKLET

Copyright 1947
The Psychological Corporation
522 Fifth Avenue
New York 18, N. Y.

Do not make any marks in this booklet

Mark your answers on the separate Answer Sheet

MECHANICAL REASONING

DIRECTIONS

This test consists of a number of pictures and questions about those pictures. Look at Example X on this page to see just what to do. Example X shows a picture of two men carrying a machine part on a board and asks, "Which man has the heavier load? If equal, mark C." Man "B" has the heavier load because the weight is closer to him than to man "A," so on the separate Answer Sheet you would fill in the space under B, like this →



Now look at Example Y. The question asks, "Which weighs more? If equal, mark C." As the scale is perfectly balanced, "A" and "B" must weigh the same, so you would blacken the space under C on your separate Answer Sheet, like this →

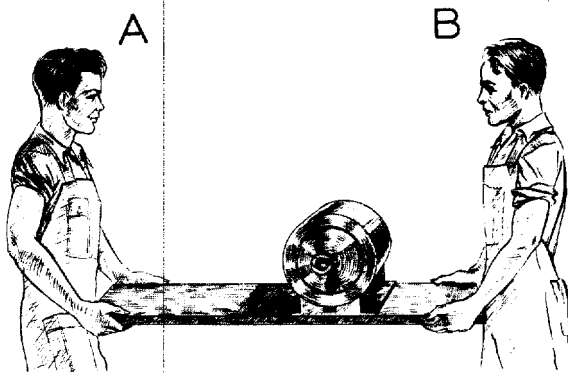
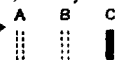

X

Which man has the heavier load?
(If equal, mark C.)

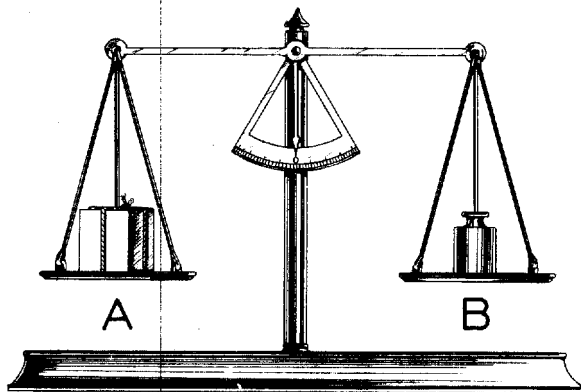

Y

Which weighs more?
(If equal, mark C.)

On the following pages there are more pictures and questions. Read each question carefully, look at the picture, and mark your answer on the separate Answer Sheet. Do not forget that there is a third choice for every question.

DO NOT TURN OVER THE BOOKLET UNTIL YOU ARE TOLD TO DO SO.

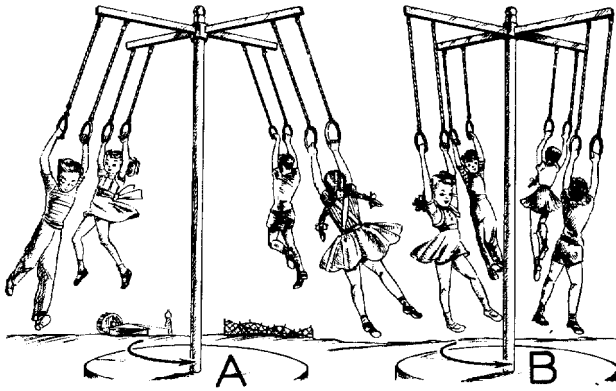

1

In which picture are the children whirling faster?
(If equal, mark C.)

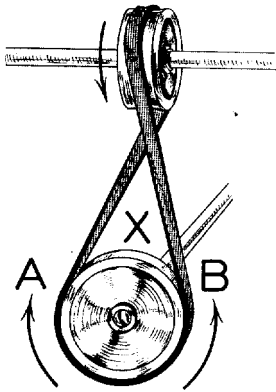

2

When the top pulley turns in the direction shown, which way will the lower pulley turn?
(If either, mark C.)

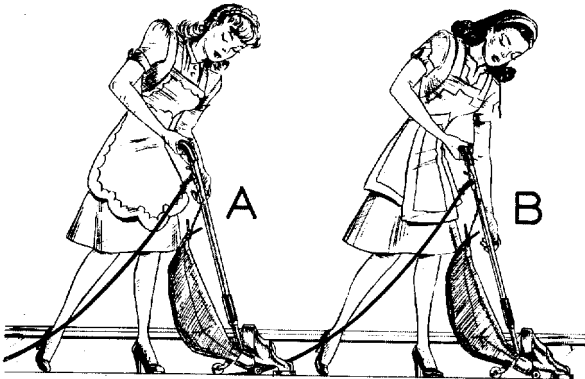

3

Which girl can lift the cleaner more easily?
(If equal, mark C.)

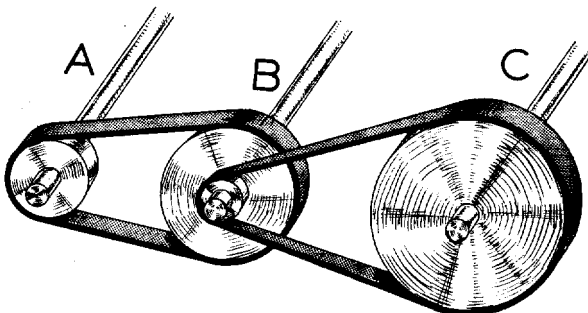

4

Which shaft will turn most slowly?

4

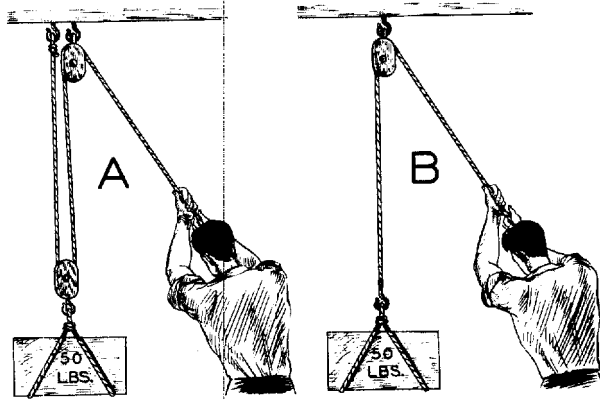

5

Which man must pull harder to lift the weight?
(If equal, mark C.)

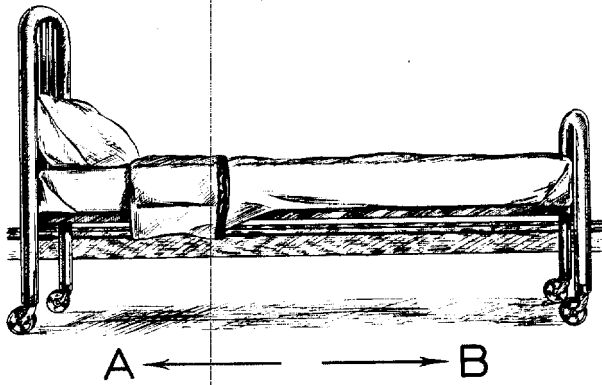

6

Which way has this bed just been rolled?
(If either, mark C.)

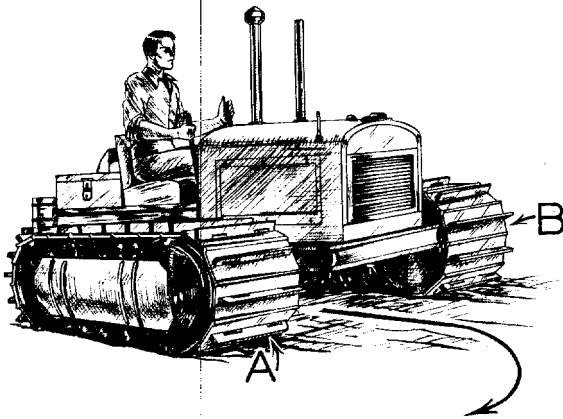

7

Which tread must stop for the tractor to turn in the direction shown?
(If neither, mark C.)

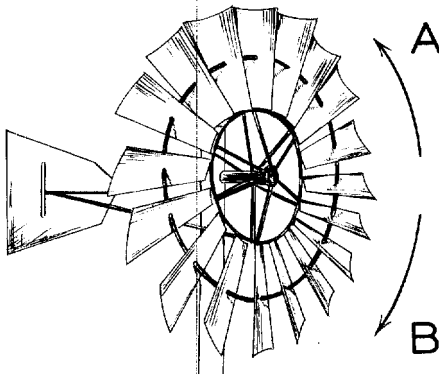

8

In which direction is this windmill more likely to turn?
(If either, mark C.)

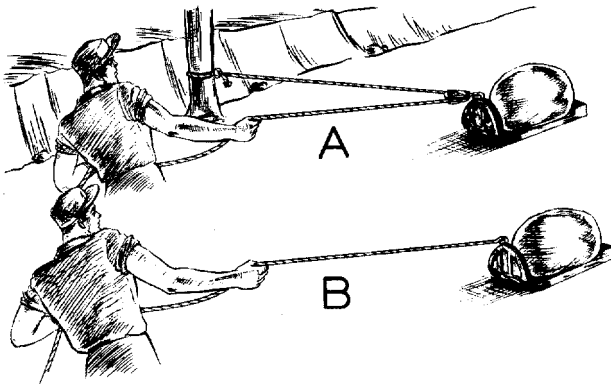

9

Which man has to pull harder?
(If equal, mark C.)

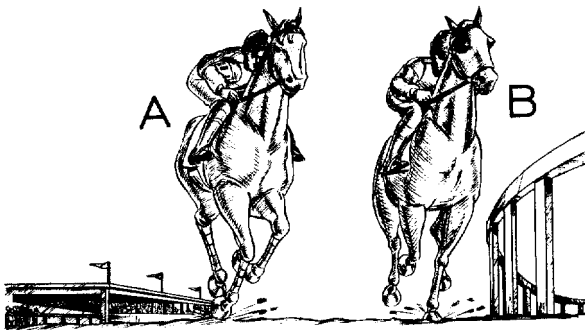

10

Which horse must go faster to
hold his place on the turn?
(If equal, mark C.)

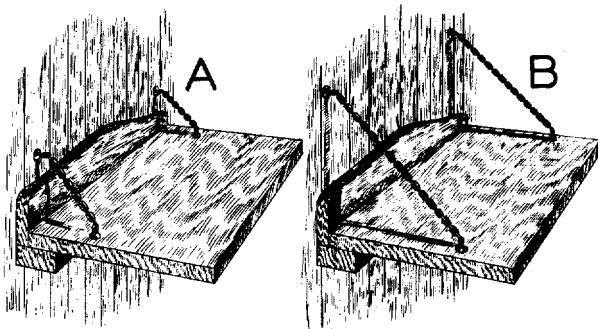

11

Which shelf is stronger?
(If equal, mark C.)

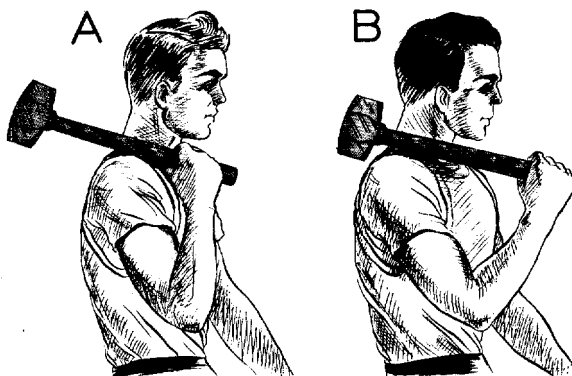

12

Which is the harder way to carry
the hammer?
(If equal, mark C.)

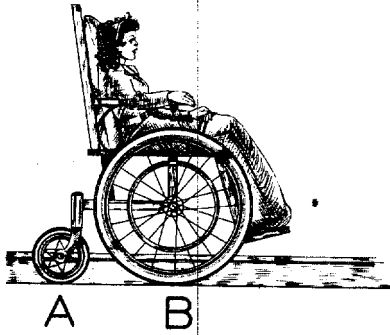

13

Which wheel will turn faster?
(If equal, mark C.)

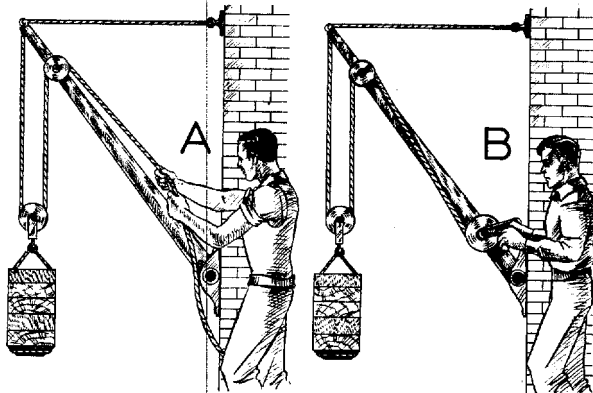

14

Which man can lift the weight
more easily?
(If equal, mark C.)

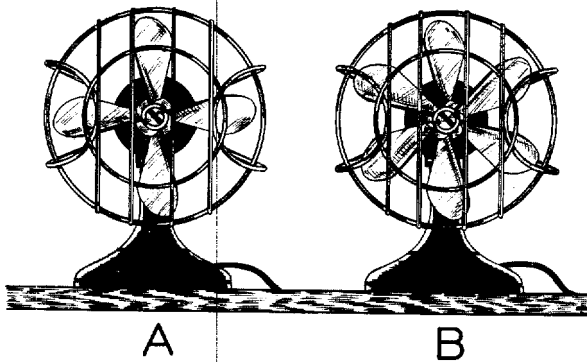

15

Which fan needs the more power-
ful motor?
(If equal, mark C.)

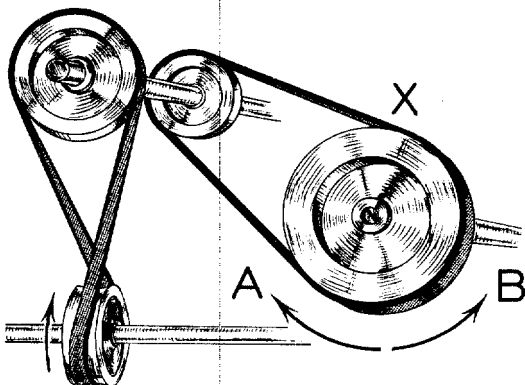

16

Which way will pulley "X" turn?
(If either, mark C.)

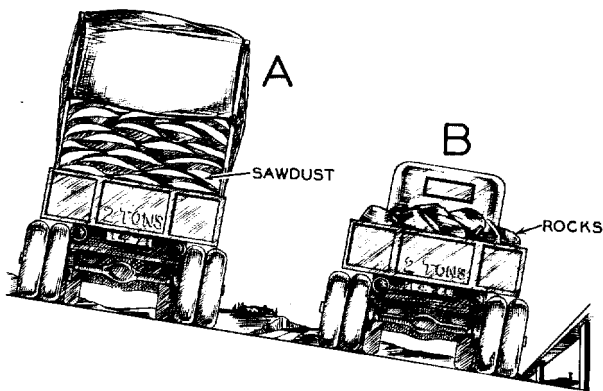

17

Which truck will turn over more easily?
(If equal, mark C.)

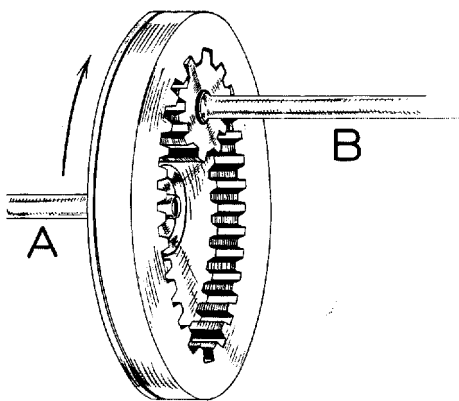

18

Which shaft turns faster?
(If equal, mark C.)

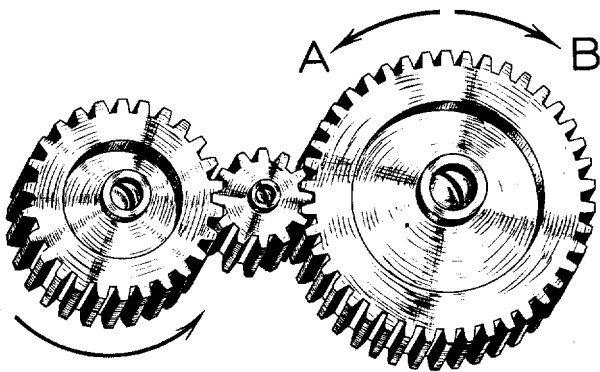

19

When the left-hand gear turns in the direction shown, which way does the right-hand one turn?
(If either, mark C.)

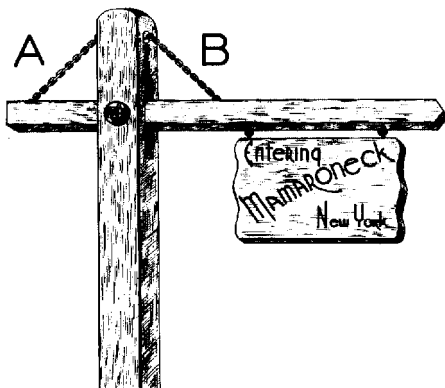

20

Which chain alone will hold up the sign?
(If either, mark C.)

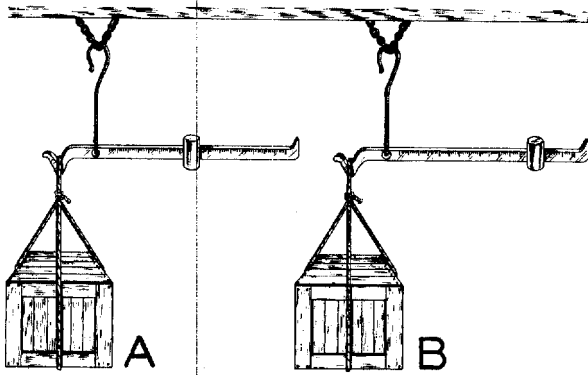

21

Which box weighs more?
(If equal, mark C.)

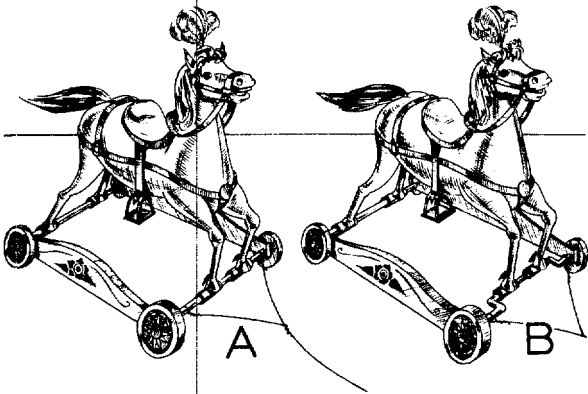

22

Which horse will jump more
when it is pulled?
(If equal, mark C.)

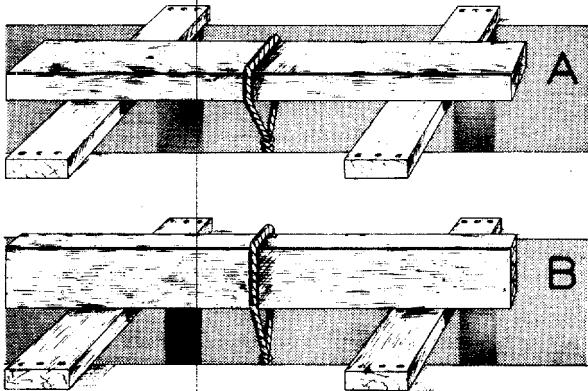

23

In which picture can you safely
put a heavier weight on the rope?
(If equal, mark C.)

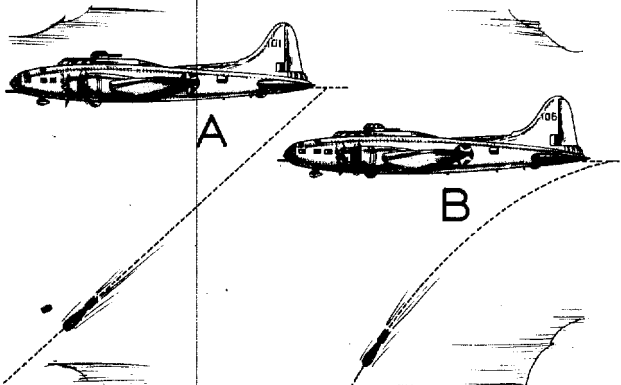

24

Which drawing shows how a
bomb really falls?
(If both, mark C.)

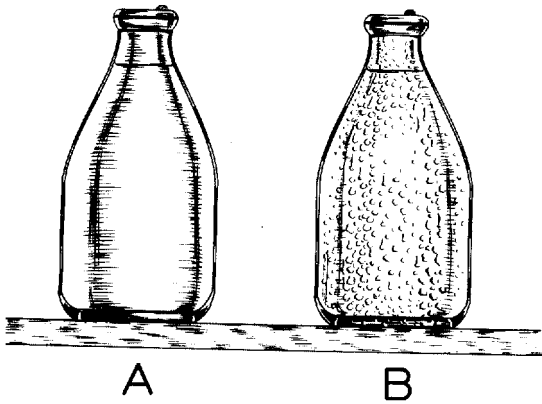

25

Which bottle has just been taken from the refrigerator?
(If neither, mark C.)

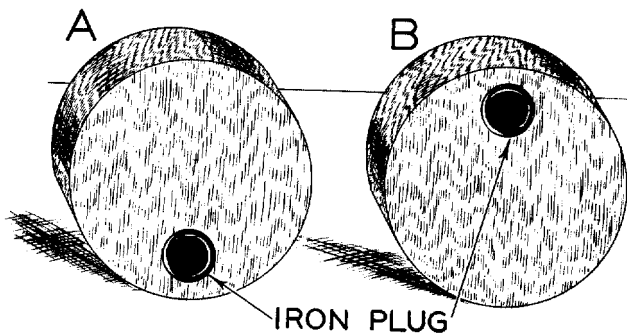

26

Which picture shows how this wooden circle will stand?
(If neither, mark C.)

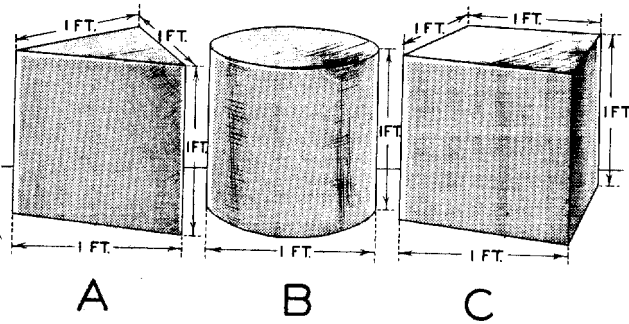

27

Which weighs least?

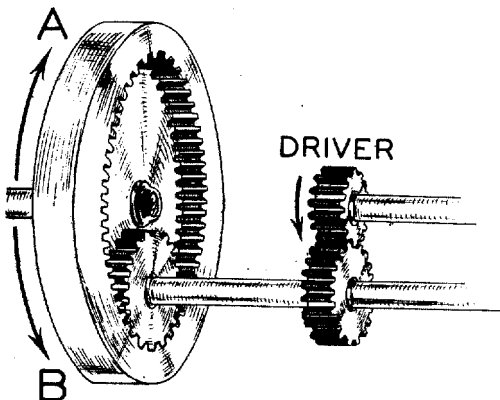

28

When the driver turns in the direction shown, which way will the left-hand gear turn?
(If either, mark C.)

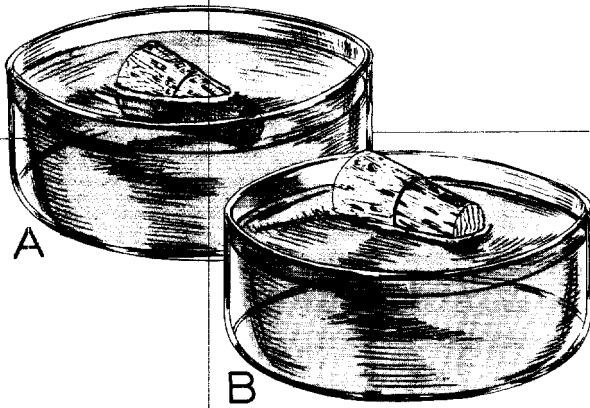

29

Which liquid is heavier?
(If equal, mark C.)

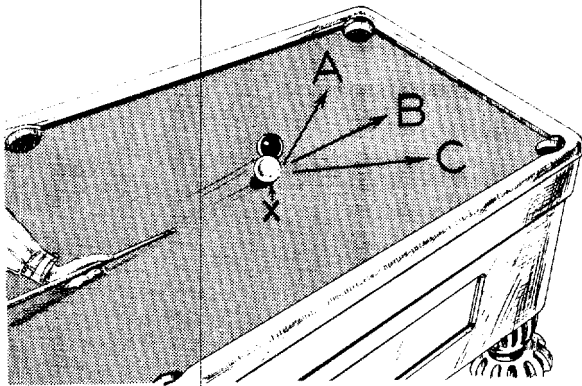

30

After hitting the black ball, which way will ball "X" go?

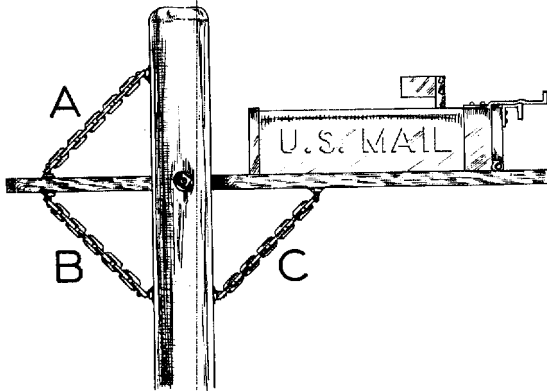

31

Which one piece of chain is needed to support the mail box?

CURB

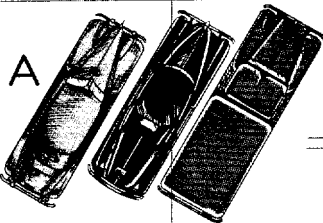

32

CURB



Which way can more cars be parked in a block?
(If equal, mark C.)

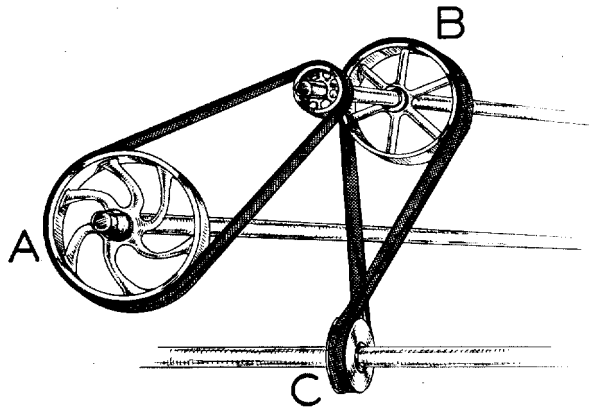

33

Which shaft will turn most rapidly?

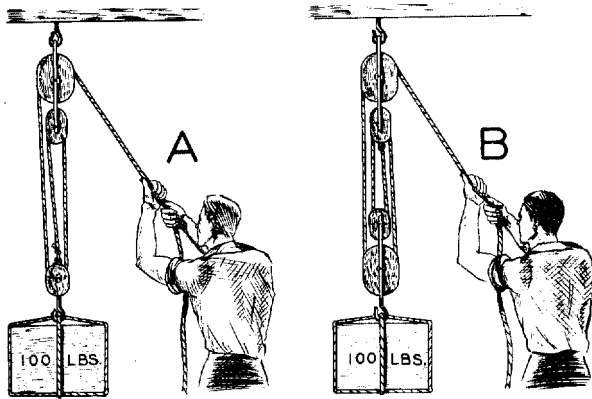

34

Which man can lift the load more easily?
(If equal, mark C.)

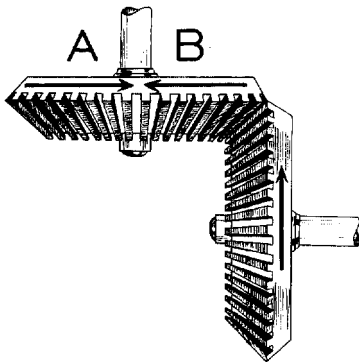

35

When the right-hand gear turns in the direction shown, which way does the top gear turn?
(If neither, mark C.)

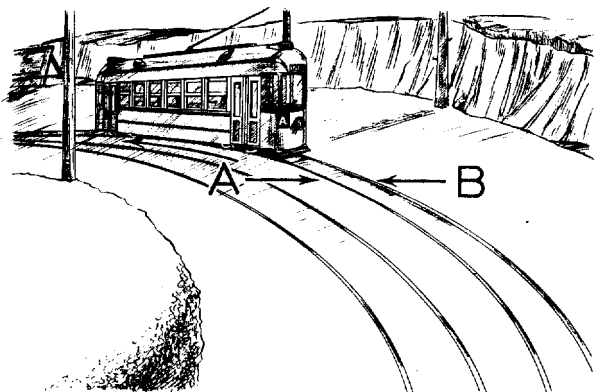

36

Which rail should be higher?
(If equal, mark C.)

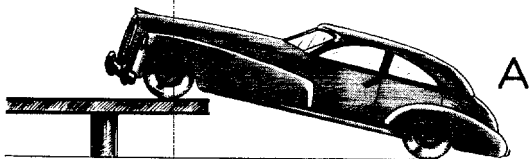

A

37

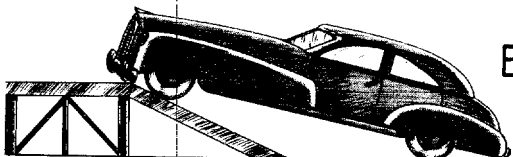

B

Which car is less likely to roll?
(If equal, mark C.)

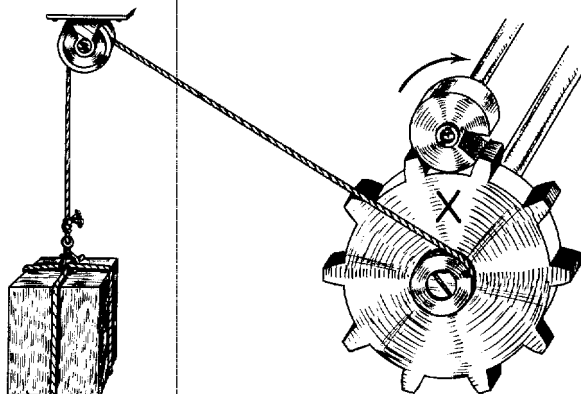

38

The top of wheel "X" will go:
(A) steadily to the right;
(B) steadily to the left;
(C) by jerks to the left.

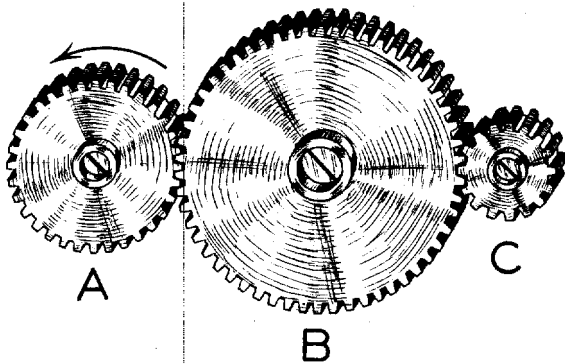

39

Which gear turns most times in a minute?

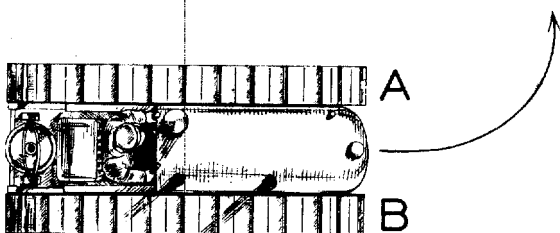

40

Which tread should be run more rapidly in order to turn the caterpillar tractor in the direction shown?
(If neither, mark C.)

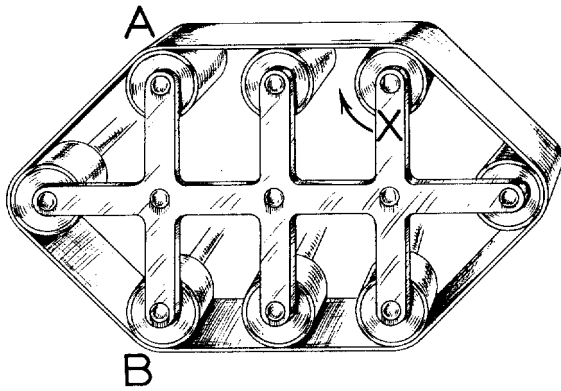

41

Which roller turns the same way as the roller at "X"?
(If both, mark C.)

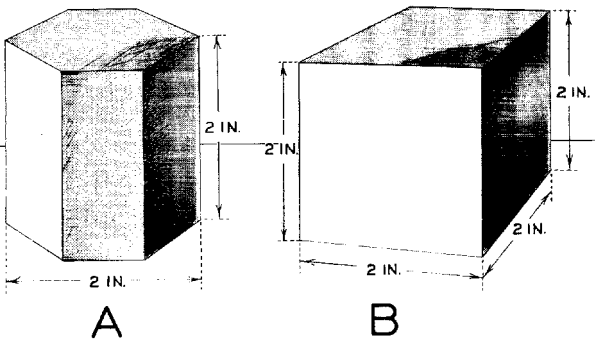

42

Which weighs more?
(If equal, mark C.)

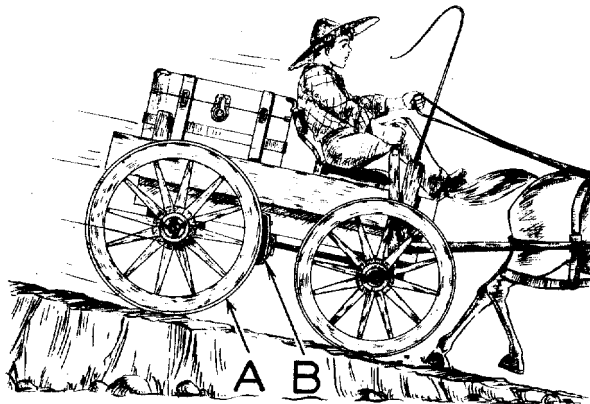

43

When the brake is put on, which part gets hotter?
(If equal, mark C.)

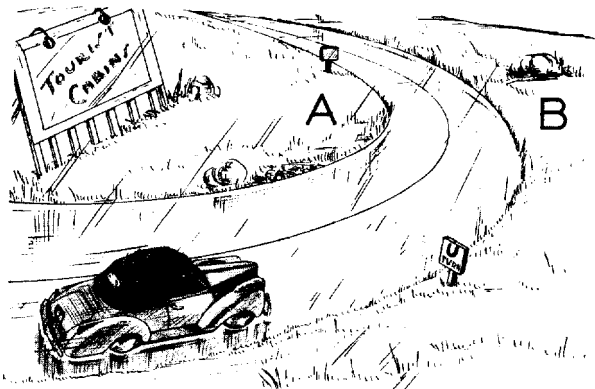

44

Off which side of the road is the car more likely to skid?
(If equal, mark C.)

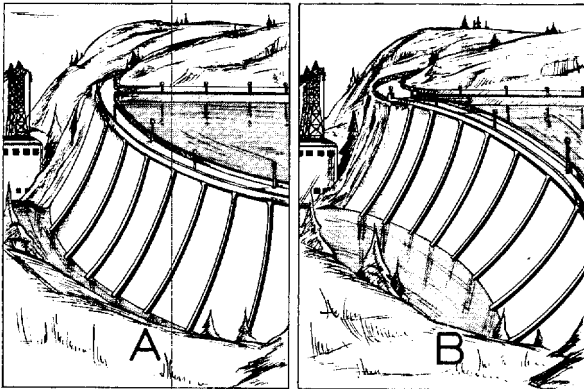

45

Which dam is stronger?
(If equal, mark C.)

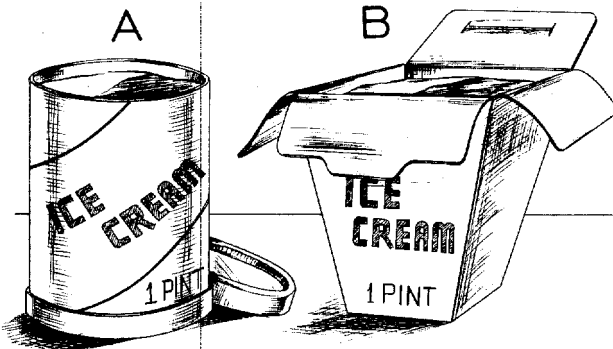

46

In which container will the ice cream stay hard longer?
(If equal, mark C.)

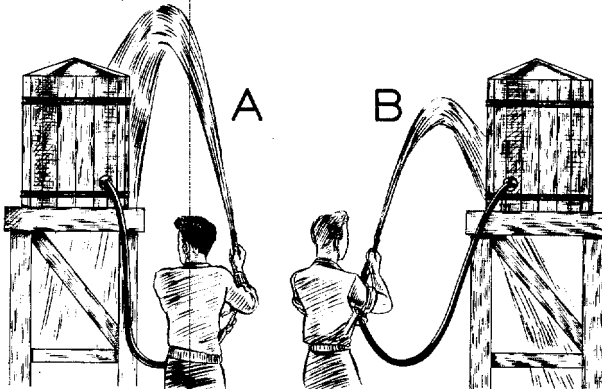

47

Which picture is correct?
(If both, mark C.)

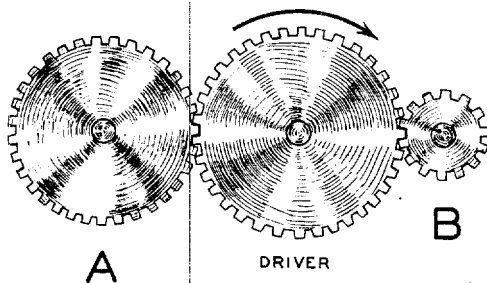

48

Which gear turns the same way as the driver?
(If neither, mark C.)

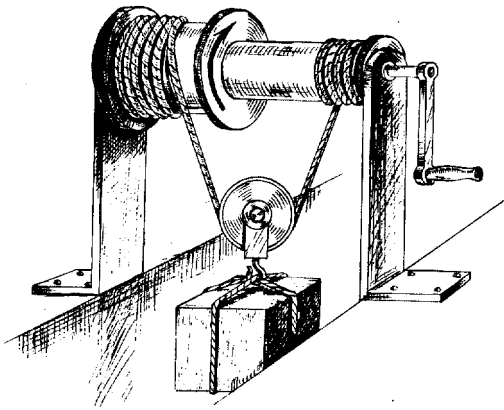

49

When the windlass is turned in the direction shown, the weight will:

- (A) fall;
- (B) stand still;
- (C) rise.

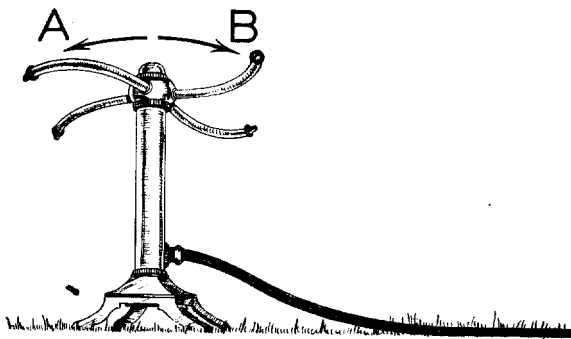

50

When the water is turned on, which way will the sprinkler turn?
(If either, mark C.)

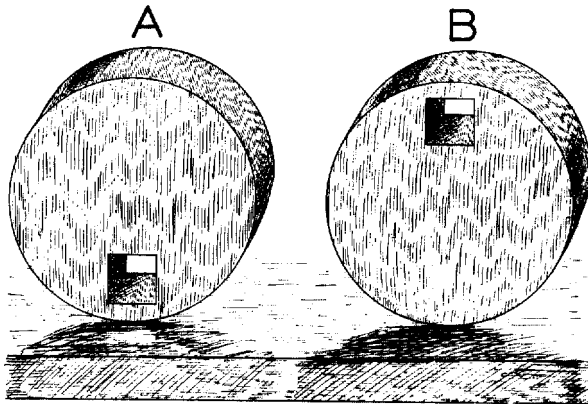

51

Which picture shows how this wooden circle will stand?
(If neither, mark C.)

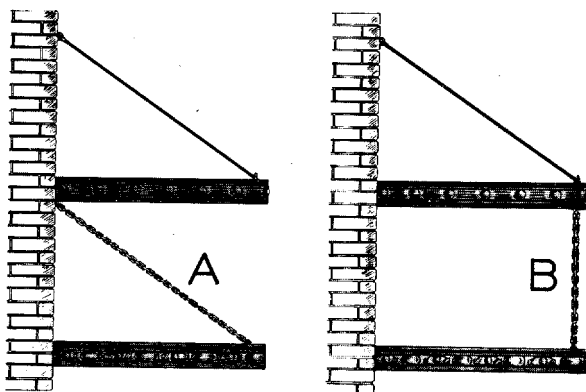

52

Which chain has more strain upon it?
(If equal, mark C.)

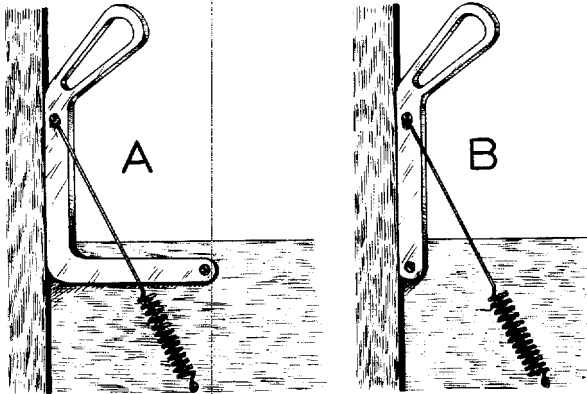

53

In which picture will the spring hold the handle where it now is?
(If both, mark C.)

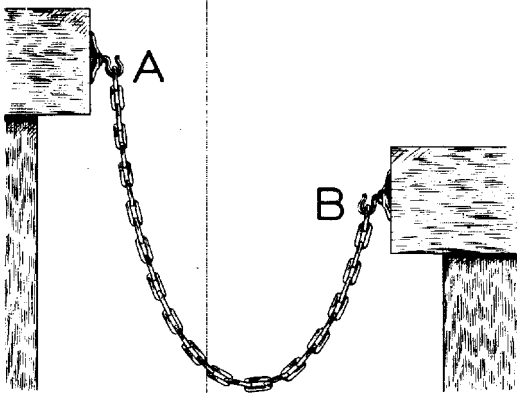

54

Which hook supports more weight?
(If equal, mark C.)

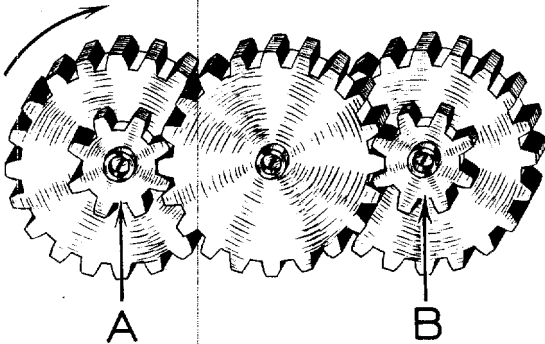

55

Which gear turns slower?
(If equal, mark C.)

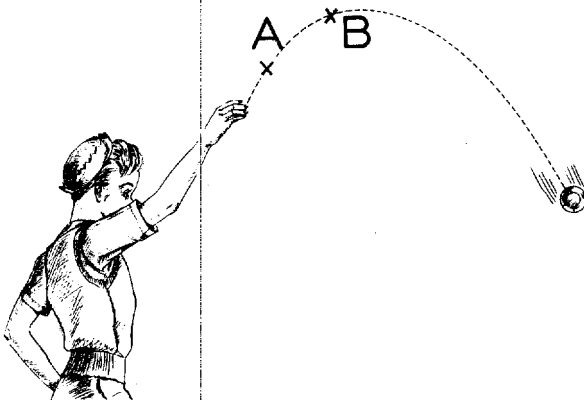

56

At which point was the ball going faster?
(If equal, mark C.)

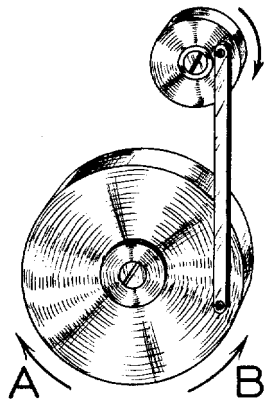

57

When the small wheel is turned around, the big wheel will:

- (A) turn in direction A;
- (B) turn in direction B;
- (C) move back and forth.

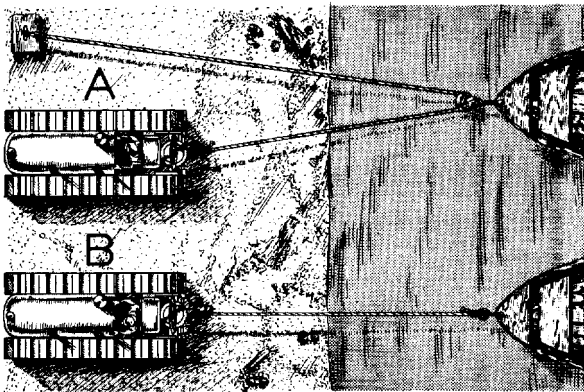

58

Which tractor must go further to pull the boat up on the beach?
(If equal, mark C.)

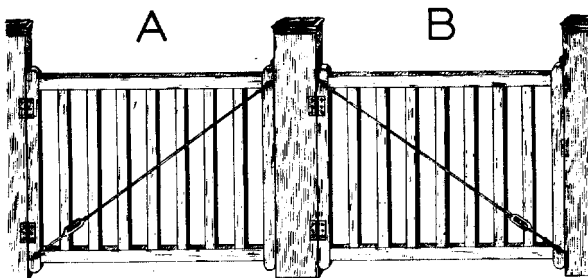

59

Which gate is better braced?
(If equal, mark C.)

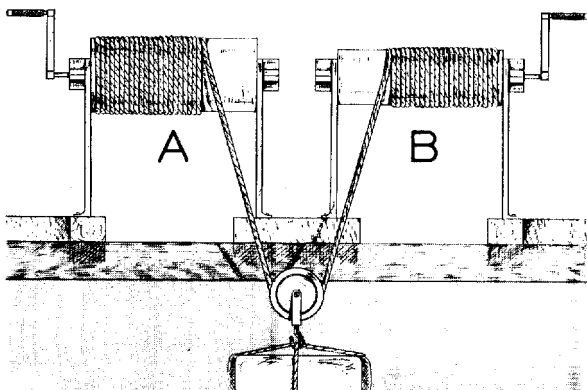

60

Which windlass will be harder to turn in order to lift the weight?
(If equal, mark C.)

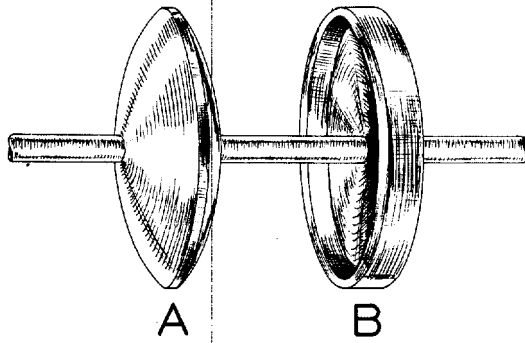

61

Which wheel is safer when spun at high speed?
(If equal, mark C.)

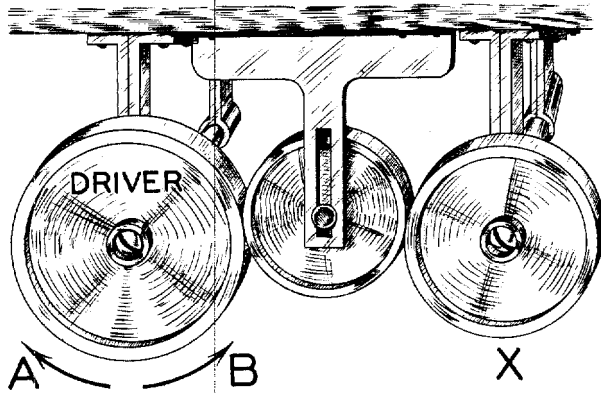

62

Which way must the driver turn to drive the wheel "X"?
(If either, mark C.)

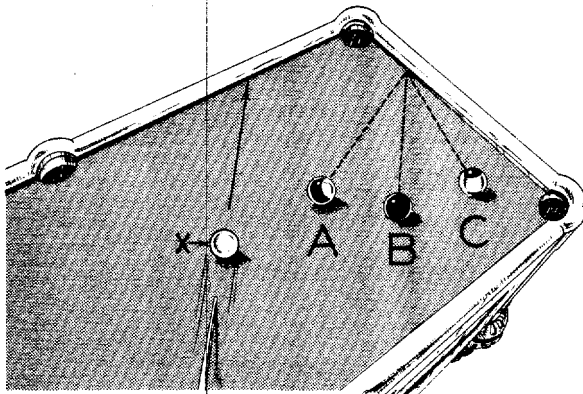

63

Which of these balls will the white ball "X" hit?

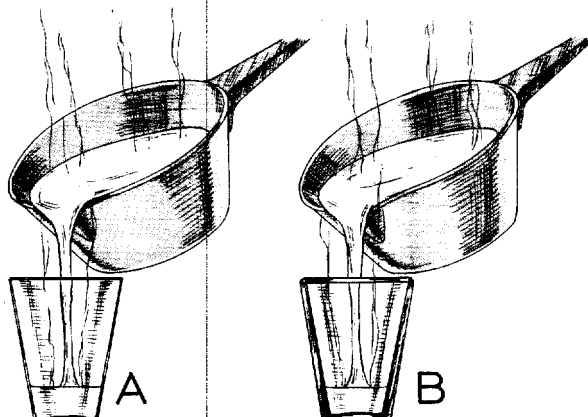

64

Which glass is more likely to break?
(If equal, mark C.)

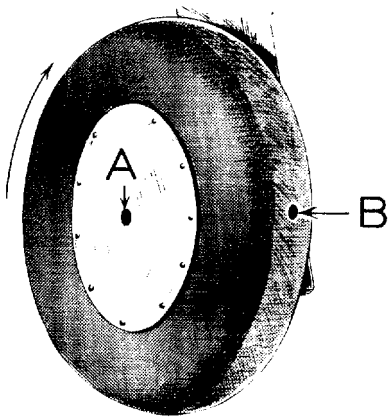

65

Which point moves faster when the wheel turns?
 (If equal, mark C.)

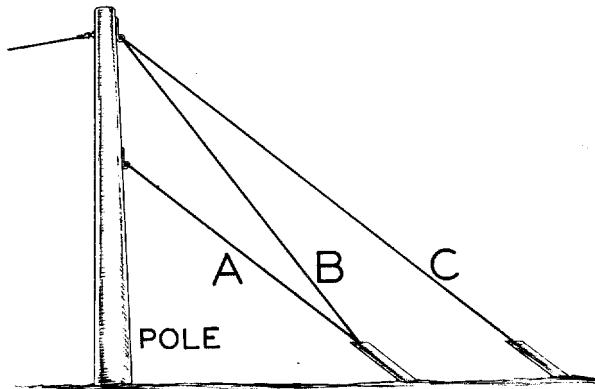

66

Which one piece of cable will give this pole the best support?

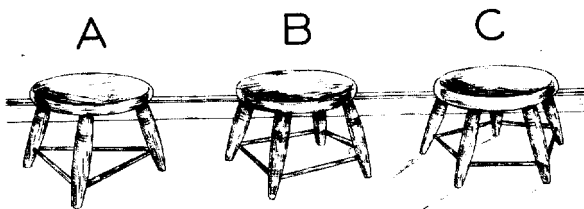

67

Which stool will be steadiest on uneven ground?

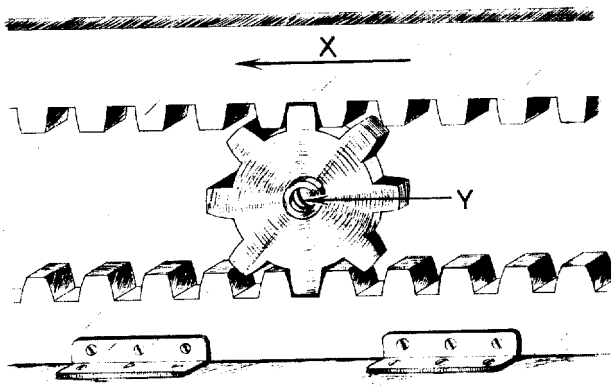

68

If "X" moves two feet in the direction shown, the center of the gear "Y" will move:

- (A) more than two feet;
- (B) less than two feet;
- (C) two feet.

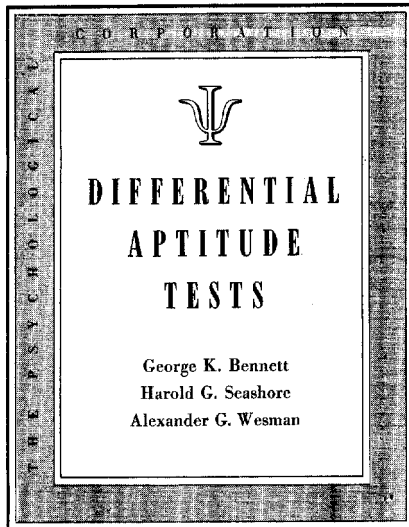

SPACE RELATIONS

FORM A

Do not open this booklet until you are told to do so.

On your SEPARATE ANSWER SHEET, print your name, address, and other requested information in the proper spaces.

In the space after Form, print an A.

Then wait for further instructions.

DO NOT MAKE ANY MARKS IN THIS BOOKLET

Copyright 1947
The Psychological Corporation
522 Fifth Avenue
New York 18, N. Y.

Do not make any
marks in this
booklet

Mark your answers
on the separate
Answer Sheet

SPACE RELATIONS

DIRECTIONS

This test consists of forty patterns which can be folded into figures. For each pattern, five figures are shown. You are to decide which of these figures can be made from the pattern shown. The pattern always shows the outside of the figure. Here is an example:

EXAMPLE X

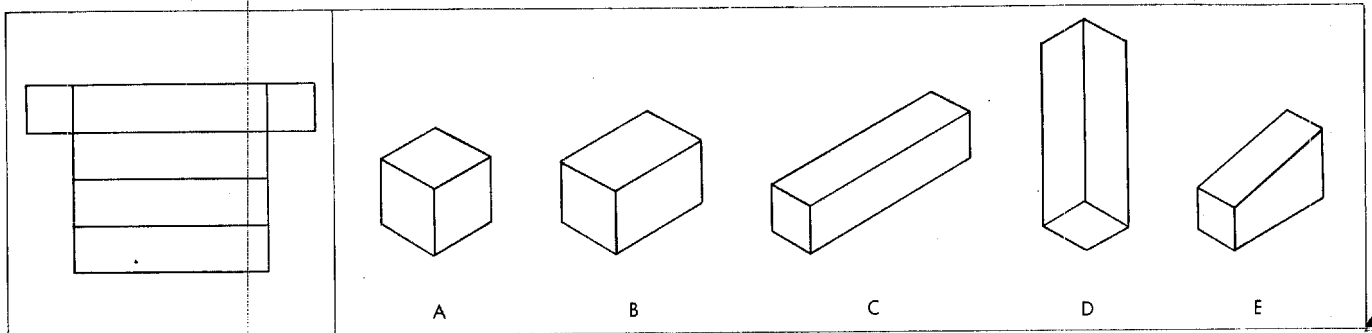

Which of these five figures — A, B, C, D, E — can be made from the pattern in Example X? A and B certainly cannot be made; they are not the right shape. C and D are correct both in shape and size. You cannot make E from this pattern.

- In the test there will always be a row of five figures for each pattern.
- In every row there is at least one correct figure.
- Usually more than one is correct. In fact, in some cases, all five may be correct.

Now look at the pattern for Example Y and the five choices for it. Note that when the pattern is folded, the figure must have two gray surfaces. One of these is a large surface which could be either the top or bottom of a box. The other is a small surface which would be one end of the box.

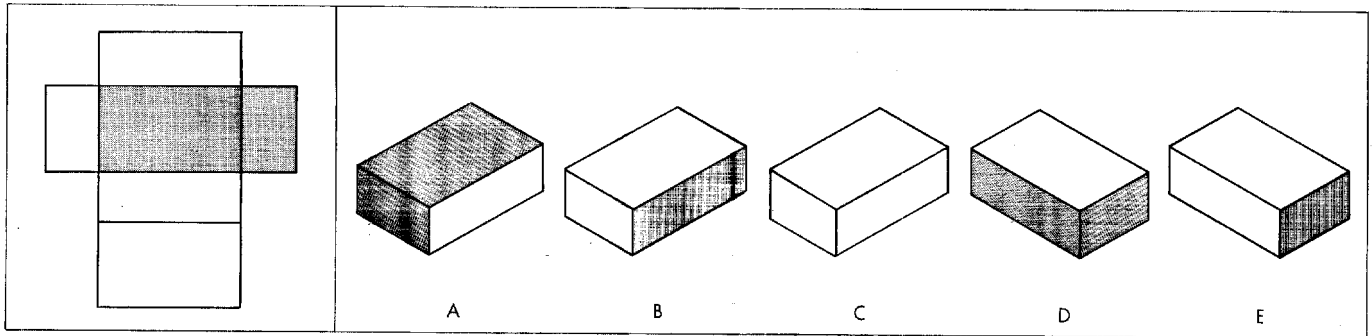

Notice — all the “boxes” made from this pattern are correct in **shape**, but the sides which you see are different. Some of these figures can be made from this pattern while others cannot. Let us look at them.

— Figure A is correct. If the large gray surface is shown as the top, then the end surface of gray can be shown facing towards you.

— Figure B is wrong. The **long, narrow** side is not gray in the pattern.

— Figure C is correct. The two gray surfaces can both be hidden by placing the large gray surface at the bottom and the gray end to the back.

— Figure D is wrong. The gray end is all right, but there is no long gray side in the pattern.

— Figure E is correct. One can show the box so that the large gray surface is at the bottom (as it was in C), but with the gray end showing at the front.

So, you see, there are three figures (A, C and E) which can be made from the pattern in Example Y, and two figures (B and D) which cannot be made from this pattern.

Remember that the surface you see in the pattern must always be the **OUTSIDE** surface of the completed figure.

Now let's see how we mark our answers on the separate Answer Sheet. A sample is shown here.

For Example X we found that only figures C and D could be made, so the spaces under C and D opposite X have been blackened. For Example Y, A is a correct figure, C is correct, and E is correct, so opposite Y we have blackened in the spaces under A, C and E.

SAMPLE OF ANSWER SHEET

X	A	B	C	D	E
	⋮	⋮	█	█	⋮
Y	█	⋮	█	⋮	█

In taking the test:

- Study each pattern.
- Decide which of the figures can be made from the pattern.
- Show your choices on the Answer Sheet by blackening in the little space under the letter which is the same as that of the figure you have chosen in the booklet.
- If you decide a certain figure cannot be made from the Pattern, make no mark on the Answer Sheet.

Do Not Write Anything in This Booklet
 Use Separate Answer Sheet
 You Will Be Told When to Begin

1

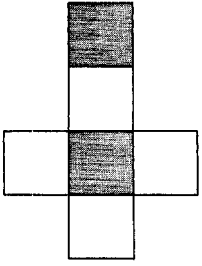

A

B

C

D

E

2



A

B

C

D

E

3

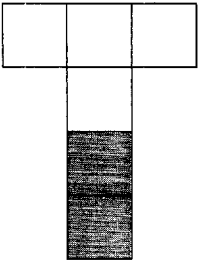

A

B

C

D

E

4

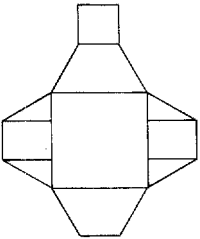

A

B

C

D

E

5

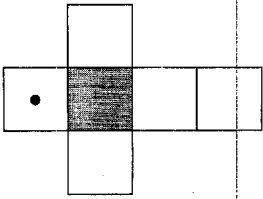

A

B

C

D

E

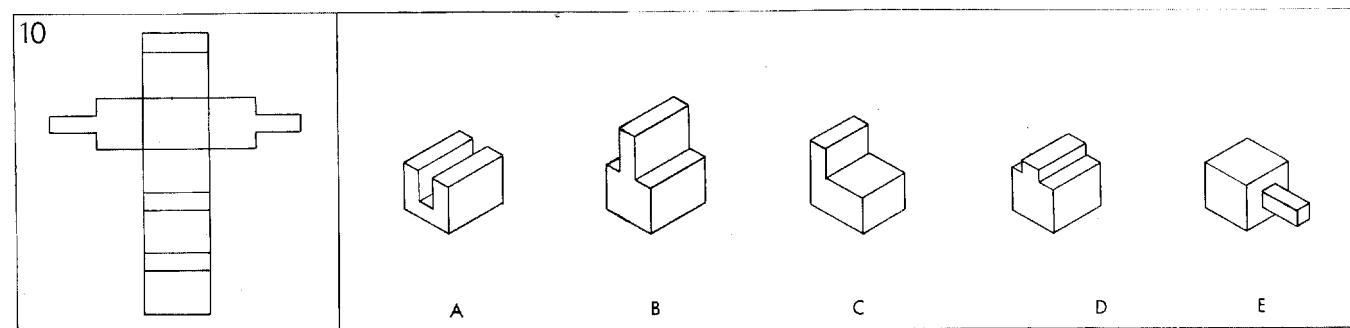
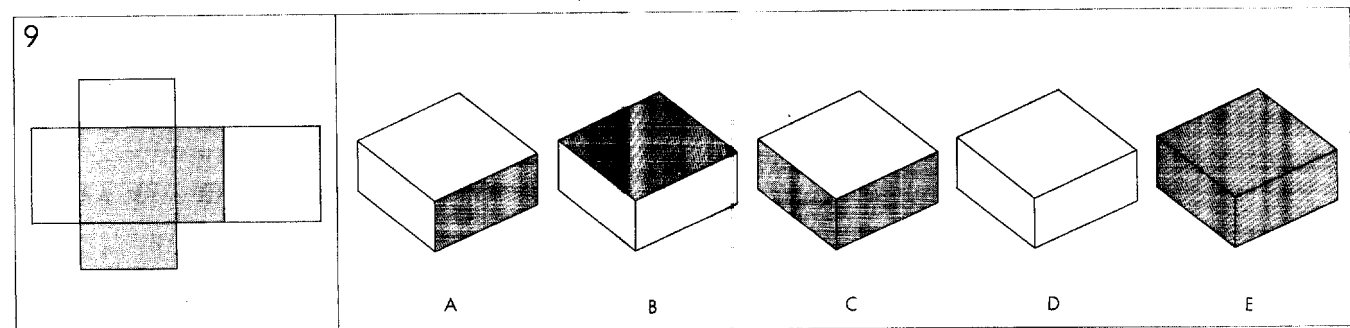
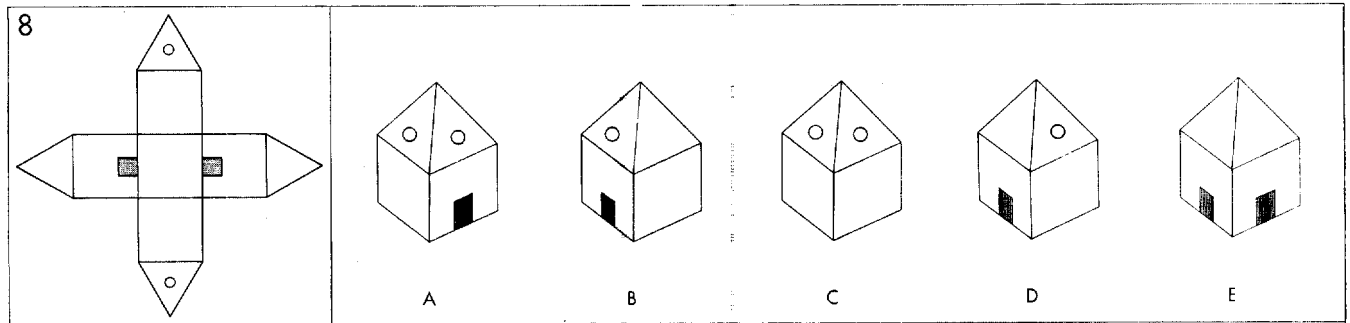
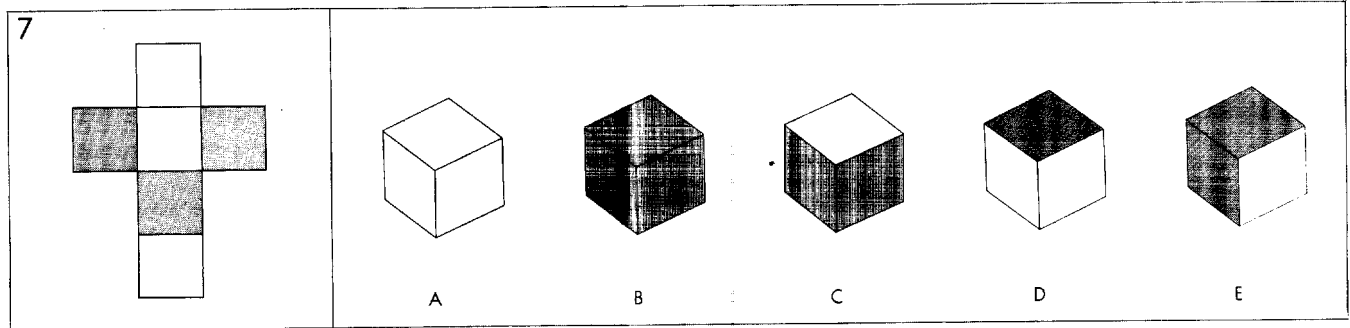
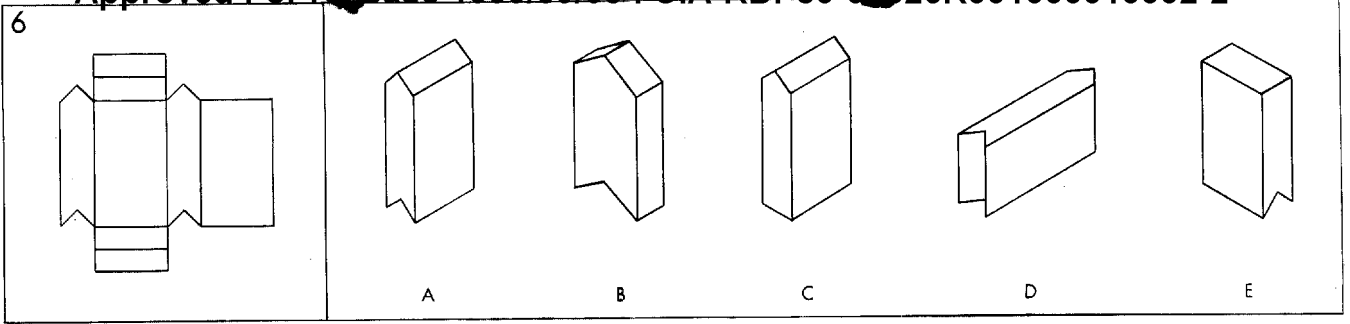

11

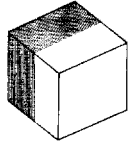
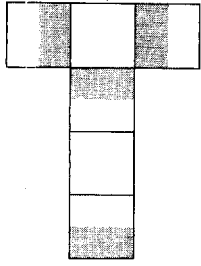

A

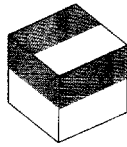

B

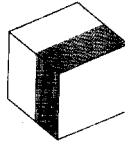

C

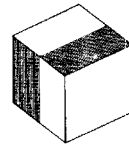

D

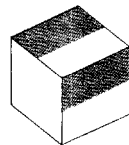

E

12

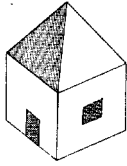
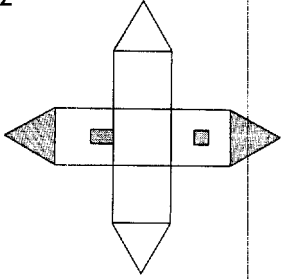

A

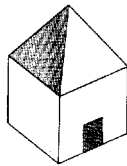

B

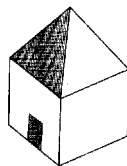

C

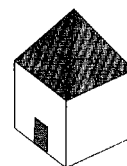

D

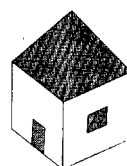

E

13

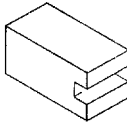
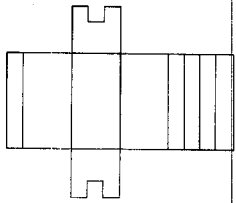

A



B

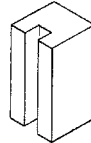

C

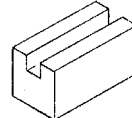

D



E

14

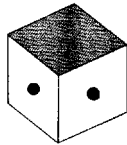
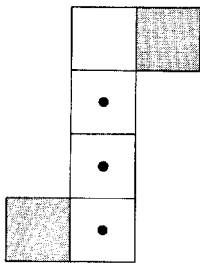

A

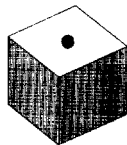

B

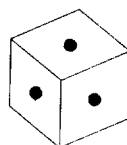

C

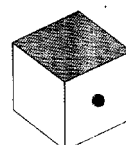

D

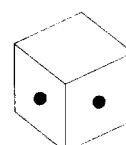

E

15

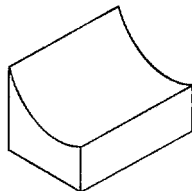
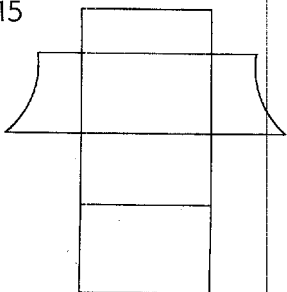

A

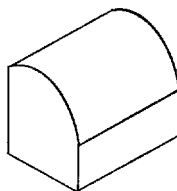

B

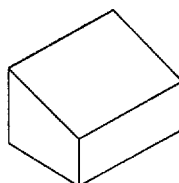

C

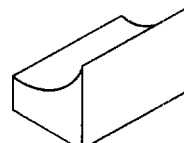

D

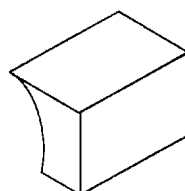

E

16

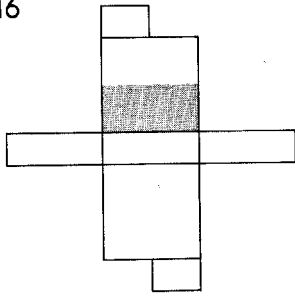

A B C D E

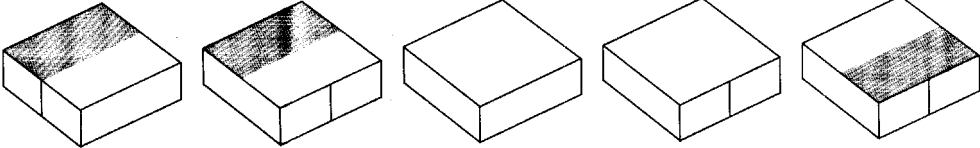

17

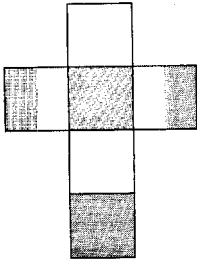

A B C D E

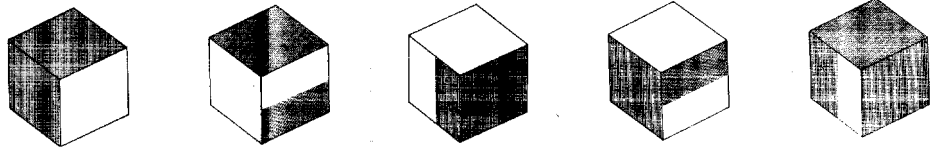

18

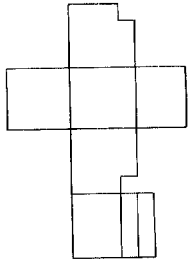

A B C D E

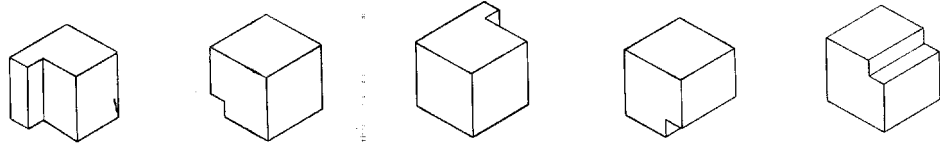

19

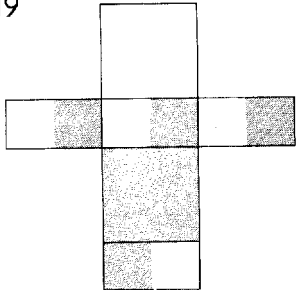

A B C D E

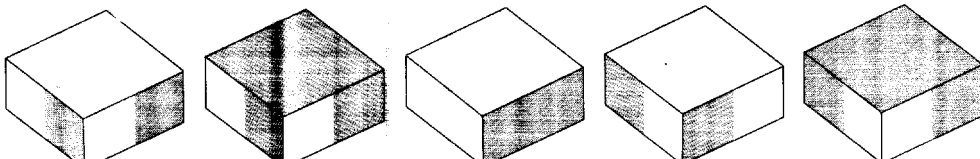

20

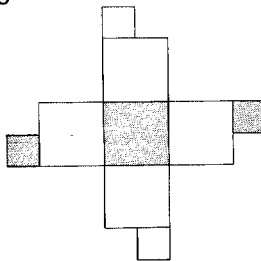

A B C D E

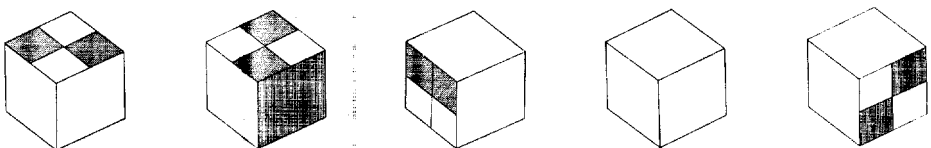

21

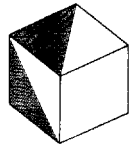
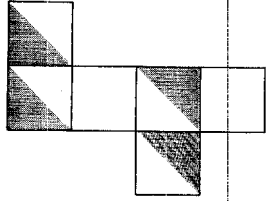

A

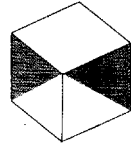

B

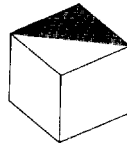

C

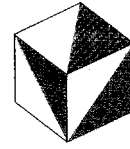

D

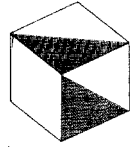

E

22

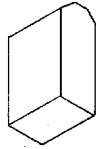
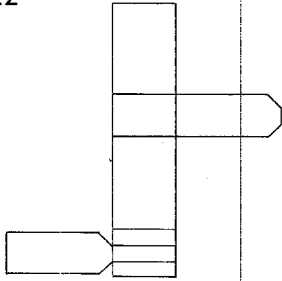

A

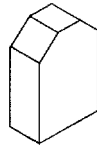

B

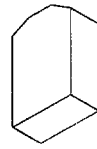

C

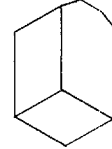

D

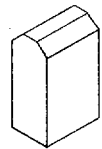

E

23

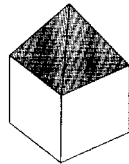
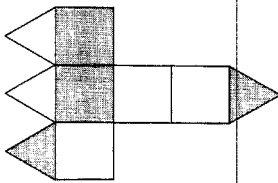

A

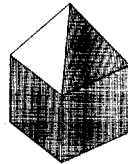

B

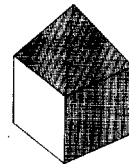

C



D

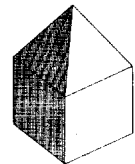

E

24

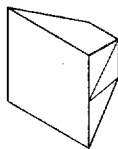
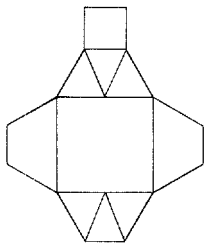

A

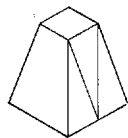

B

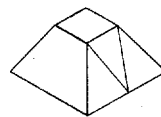

C

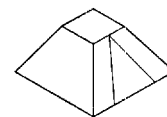

D

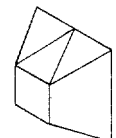

E

25

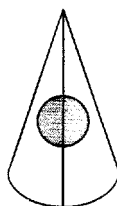
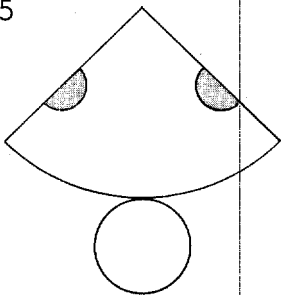

A

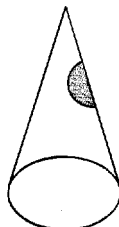

B

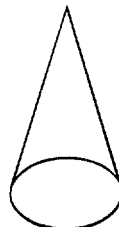

C



D

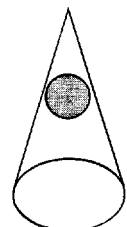

E

26

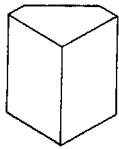
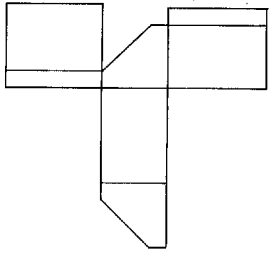

A

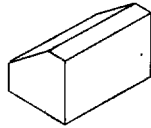

B

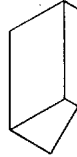

C

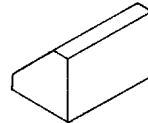

D

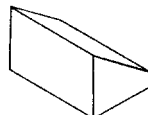

E

27

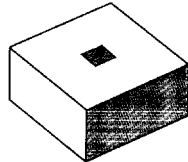
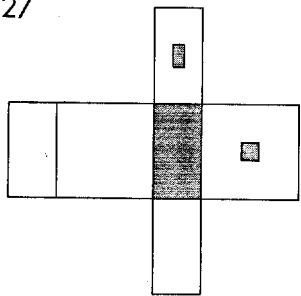

A

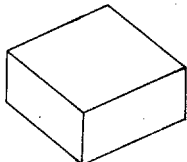

B

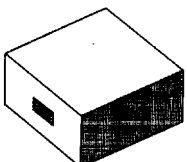

C

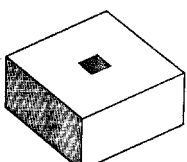

D

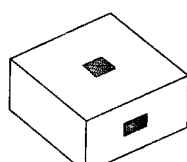

E

28

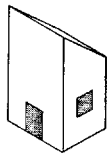
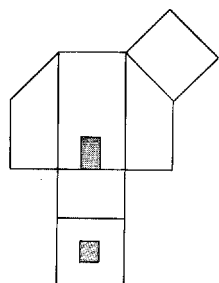

A

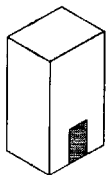

B

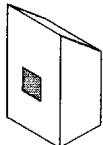

C

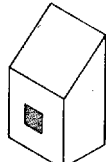

D

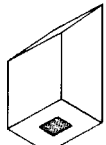

E

29

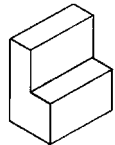
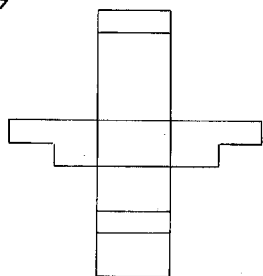

A

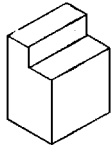

B

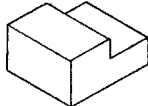

C

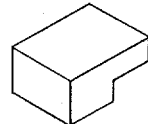

D

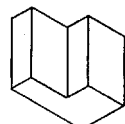

E

30

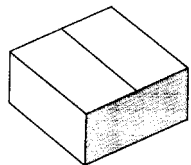
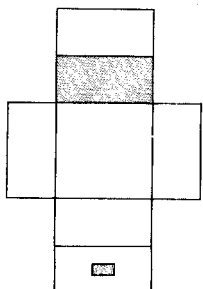

A

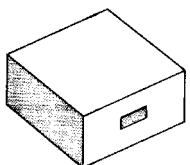

B

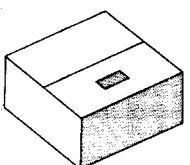

C

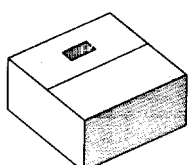

D

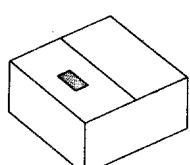

E

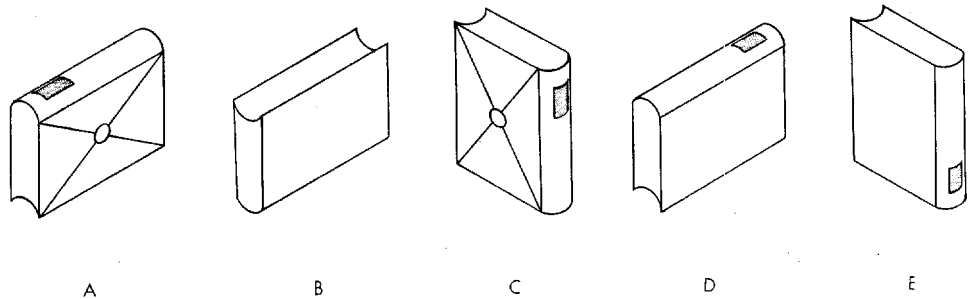
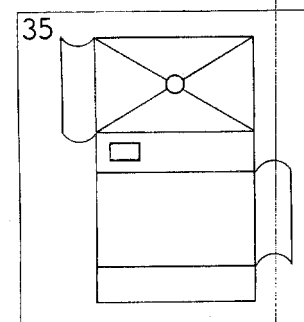
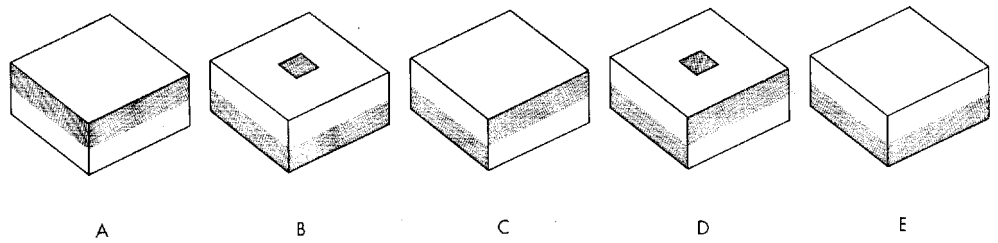
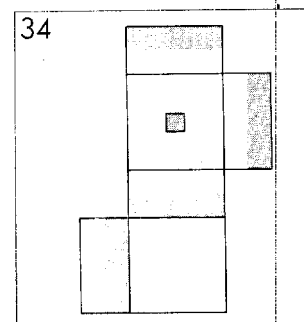
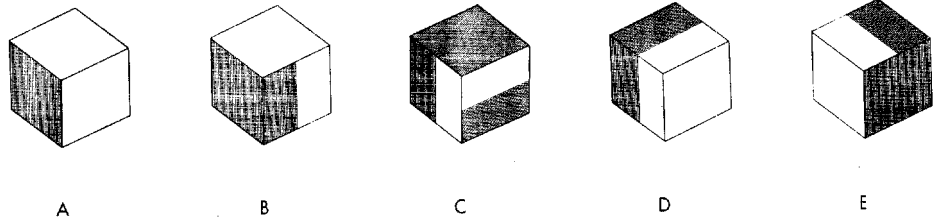
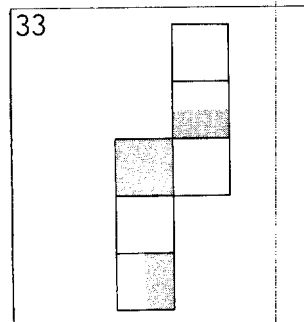
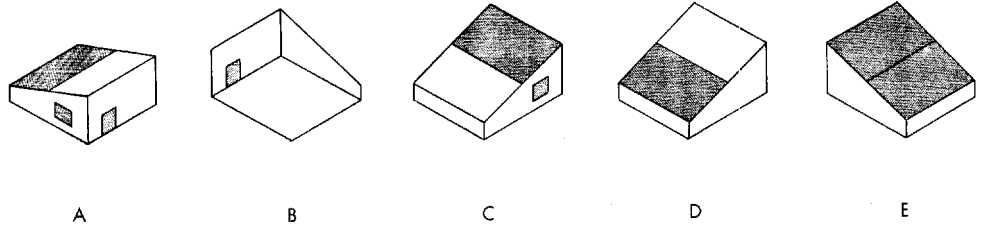
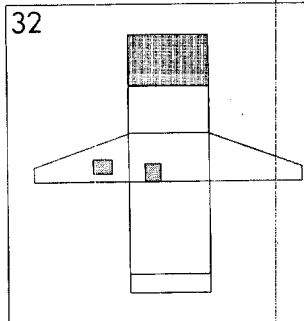
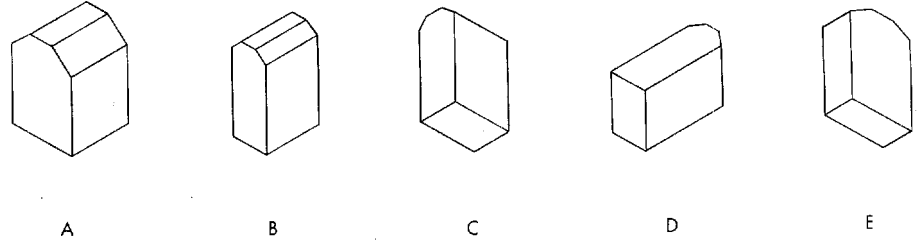
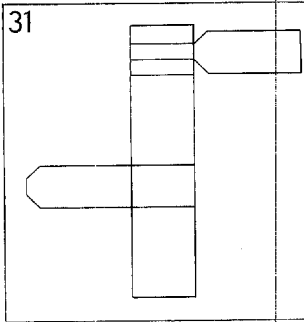

36

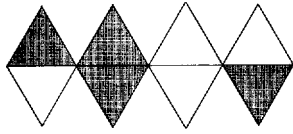

A

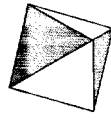

B



C

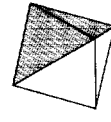

D

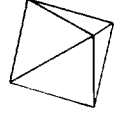

E

37

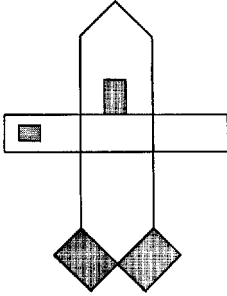

A



B



C



D

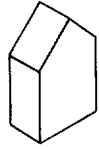

E

38

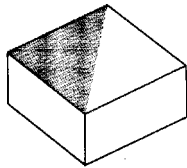
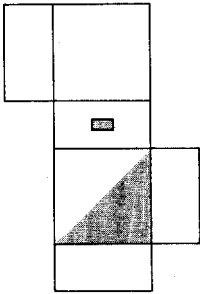

A

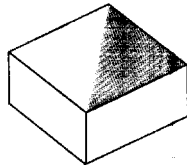

B

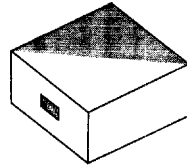

C

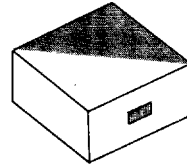

D

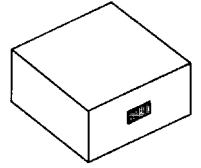

E

39

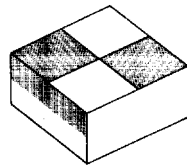
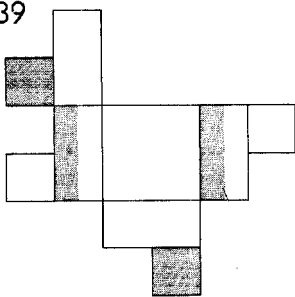

A

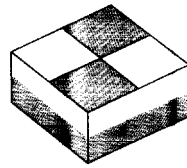

B

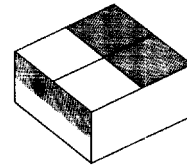

C

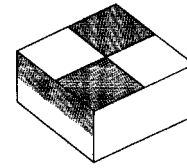

D

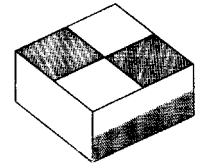

E

40

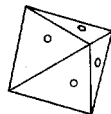
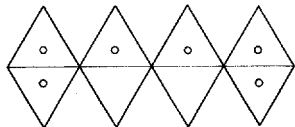

A

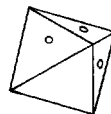

B

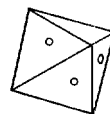

C

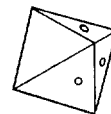

D

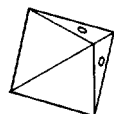

E

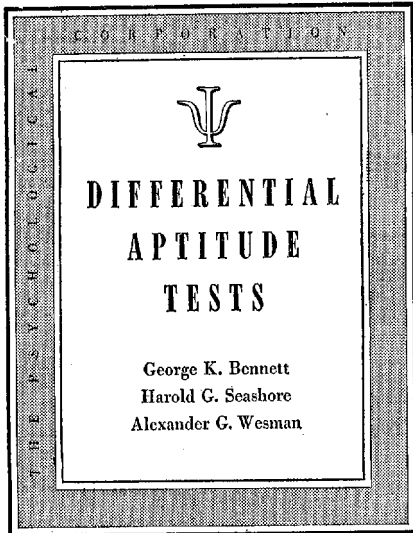

VERBAL REASONING

FORM A

Do not open this booklet until you are told to do so.

On your SEPARATE ANSWER SHEET, print your name, address, and other requested information in the proper spaces.

In the space after Form, print an A.

Then wait for further instructions.

DO NOT MAKE ANY MARKS IN THIS BOOKLET.

Copyright 1947
The Psychological Corporation
522 Fifth Avenue
New York 18, N. Y.

Do not make any marks in this booklet

VERBAL REASONING

Mark your answers on the separate Answer Sheet

DIRECTIONS

Each of the fifty sentences in this test has the first word and the last word left out. You are to pick out words which will fill the blanks so that the sentence will be true and sensible.

For the first blank, pick out a numbered word — 1, 2, 3, or 4. For the blank at the end of the sentence, pick one of the lettered words — A, B, C, or D. **Combine** the number and the letter you have chosen and mark that combination on the separate Answer Sheet after the number of the question you are working on.

EXAMPLE X.is to water as eat is to.....

- | | | | |
|-------------|----------|---------|-------------|
| 1. continue | 2. drink | 3. foot | 4. girl |
| A. drive | B. enemy | C. food | D. industry |

Drink is to water as eat is to food. Drink is numbered 2, and food is lettered C, 2 and C are combined as 2C. The space under 2C has been filled in on line X on the sample Answer Sheet shown below.

Now look at the next example.

EXAMPLE Y.is to one as second is to.....

- | | | | |
|-----------|----------|-----------|----------|
| 1. middle | 2. queen | 3. rain | 4. first |
| A. two | B. fire | C. object | D. hill |

First is to one as second is to two. 4A has been properly marked on line Y on the sample Answer Sheet as the correct answer. 4 is the number for first; A is the letter for two. They were combined to make 4A which was filled in on the sample Answer Sheet.

EXAMPLE Z.is to night as breakfast is to.....

- | | | | |
|------------|------------|-----------|-----------|
| 1. flow | 2. gentle | 3. supper | 4. door |
| A. include | B. morning | C. enjoy | D. corner |

Supper, numbered 3, is to night as breakfast is to morning, lettered B. This number and this letter make the combination 3B which has been found and blackened on line Z on the sample Answer Sheet.

Fill in **only one** space for each question.

SAMPLE OF ANSWER SHEET

X	1A	1B	1C	1D	2A	2B	2C	2D	3A	3B	3C	3D	4A	4B	4C	4D
	■
Y	1A	1B	1C	1D	2A	2B	2C	2D	3A	3B	3C	3D	4A	4B	4C	4D

Z	1A	1B	1C	1D	2A	2B	2C	2D	3A	3B	3C	3D	4A	4B	4C	4D
	■

DO NOT TURN THE PAGE UNTIL YOU ARE TOLD TO DO SO.

Do not make any marks in this booklet.
Mark your answers on the separate answer sheet.

1.is to street as rd. is to....

1. lo.	2. ma.	3. st.	4. aw.
A. city	B. France	C. end	D. road

2.is to cavalry as foot is to....

1. horse	2. cemetery	3. votary	4. hiding
A. yard	B. travel	C. armory	D. infantry

3.is to wide as thin is to....

1. store	2. narrow	3. nothing	4. street
A. fat	B. weight	C. man	D. present

4.is to masculine as woman is to....

1. disguise	2. malicious	3. virile	4. man
A. intuitive	B. madame	C. feminine	D. girl

5.is to dispute as endure is to....

1. impute	2. repute	3. argue	4. distaff
A. last	B. verdure	C. imbue	D. invert

6.is to verse as sculptor is to....

1. poet	2. reverse	3. free	4. music
A. crime	B. chisel	C. statue	D. artist

7.is to chain as bead is to....

1. watch	2. iron	3. pull	4. link
A. pearl	B. board	C. necklace	D. aim

8.is to animal as rind is to....

1. shell	2. husk	3. skin	4. man
A. hard	B. melon	C. nut	D. corn

9.is to cork as box is to....

1. bottle	2. fish	3. brittle	4. light
A. fight	B. lid	C. hat	D. crate

10.is to tusk as deer is to....

1. ivory	2. work	3. elephant	4. trunk
A. doe	B. hunt	C. moose	D. antler

11.is to contralto as tenor is to....

1. singer	2. soprano	3. sonata	4. solo
A. score	B. song	C. orchestra	D. baritone

12.is to hang as guillotine is to....

1. picture	2. gallows	3. criminal	4. punish
A. revolution	B. behead	C. capitulate	D. citizen

13.is to tree as melon is to....

1. bush	2. elm	3. gnarled	4. apple
A. vine	B. water	C. ripe	D. sweet

GO ON TO THE NEXT PAGE AND KEEP RIGHT ON WORKING.

14.is to pea as shell is to.....
1. green 2. sweep 3. pod 4. soup
A. rifle B. nut C. crack D. peel
15.is to steer as pork is to.....
1. beef 2. bull 3. cow 4. barn
A. steak B. lard C. chop D. pig
16.is to sentence as sentence is to.....
1. jail 2. word 3. period 4. question
A. fine B. comma C. paragraph D. phrase
17.is to Dick as Margaret is to.....
1. Richard 2. Francis 3. William 4. Benjamin
A. Mary B. Peggy C. Joan D. Frances
18.is to childhood as adolescence is to.....
1. infantry 2. infancy 3. weaning 4. health
A. adultery B. maturity C. sinecure D. intelligence
19.is to potato as beater is to.....
1. masher 2. mashed 3. skin 4. spud
A. winner B. baton C. steak D. egg
20.is to dog as Guernsey is to.....
1. terrier 2. tail 3. bark 4. cat
A. cow B. Jersey C. noble D. furniture
21.is to top as base is to.....
1. ibex 2. spin 3. side 4. apex
A. vile B. ball C. bottom D. home
22.is to eagle as Pekingese is to.....
1. flag 2. sparrow 3. dollar 4. vulture
A. Chinese B. collie C. yen D. crow
23.is to river as coast is to.....
1. flood 2. boat 3. bank 4. tide
A. beach B. spa C. sea D. sled
24.is to foot as elbow is to.....
1. man 2. thigh 3. knee 4. toe
A. hand B. thumb C. shoulder D. finger
25.is to day as calendar is to.....
1. noon 2. clock 3. sun 4. night
A. year B. week end C. March D. century

TURN THE PAGE AND KEEP RIGHT ON WORKING.

26. is to constitution as prologue is to.....
1. independence 2. law 3. preamble 4. amendment
A. eulogy B. writ C. play D. epilogue
27. is to proceed as stop is to.....
1. profit 2. halt 3. recede 4. intercede
A. prevent B. bottle C. gone D. go
28. is to horse as bray is to.....
1. drive 2. hoof 3. neigh 4. saddle
A. relay B. pony C. wagon D. donkey
29. is to sea as rebellion is to.....
1. mutiny 2. navy 3. sailor 4. river
A. revolting B. war C. land D. soldier
30. is to distance as pound is to.....
1. far 2. rod 3. Europe 4. travel
A. heavy B. ounce C. weight D. noise
31. is to door as pane is to.....
1. home 2. lock 3. wood 4. panel
A. glass B. window C. ache D. view
32. is to never as all is to.....
1. always 2. usually 3. seldom 4. often
A. none B. whole C. every D. total
33. is to future as regret is to.....
1. ahead 2. opportunity 3. forecast 4. hope
A. past B. atone C. absent D. sins
34. is to rain as levee is to.....
1. cloud 2. fog 3. water 4. umbrella
A. departure B. flood C. rise D. wash
35. is to fish as gun is to.....
1. cod 2. bait 3. rod 4. fry
A. hunt B. trigger C. shot D. bullet
36. is to pacifist as religion is to.....
1. war 2. atlantis 3. object 4. conscience
A. devout B. sacred C. atheist D. minister
37. is to deft as awkward is to.....
1. clumsy 2. hearing 3. blindness 4. newt
A. skillful B. stupid C. ugly D. left
38. is to nut as hook is to.....
1. fruit 2. sane 3. bolt 4. hazel
A. bend B. golf C. eyehole D. pitch

GO ON TO THE NEXT PAGE AND KEEP WORKING.

39.is to land as knot is to.....
 1. desert 2. mile 3. acre 4. farm
 A. rope B. meter C. sea D. mountain
40.is to bird as shed is to.....
 1. call 2. fly 3. migrate 4. moult
 A. barn B. dog C. hay D. farm
41.is to physician as secretary is to.....
 1. hospital 2. doctor 3. nurse 4. medicine
 A. office B. stenographer C. clerk D. executive
42.is to England as lira is to.....
 1. London 2. pound 3. king 4. colony
 A. Italy B. Mexico C. mandolin D. money
43.is to city as national is to.....
 1. mayor 2. Chicago 3. limits 4. municipal
 A. country B. Federal C. government D. international
44.is to prison as Louvre is to.....
 1. warden 2. Bastille 3. crime 4. bars
 A. France B. museum C. paramour D. artist
45.is to Canada as Havana is to.....
 1. Detroit 2. Nome 3. Toronto 4. Alberta
 A. Puerto Rico B. Cuba C. Mexico D. Florida
46.is to opera as lyric is to.....
 1. baritone 2. drama 3. Wagner 4. composer
 A. song B. music C. poem D. liltling
47.is to bleach as flushed is to.....
 1. color 2. gay 3. sheep 4. combine
 A. blushed B. drained C. wan D. truffle
48.is to static as dynamic is to.....
 1. radio 2. politic 3. inert 4. air
 A. speaker B. motor C. active D. regal
49.is to all as part is to.....
 1. each 2. right 3. none 4. full
 A. whole B. separate C. role D. many
50.is to diamond as circle is to.....
 1. square 2. shape 3. cube 4. gold
 A. triangle B. oval C. round D. smooth

Timed Writing

DIRECTIONS: TYPE YOUR NAME AND DATE AT THE TOP RIGHT SIDE OF THE PAPER. SPACE DOWN 10-12 SPACES (TWO INCHES) TO BEGIN TYPING. THE LEFT MARGIN SHOULD BE ABOUT ONE INCH IN WIDTH. WHEN YOU ARE TOLD TO BEGIN TYPING, TYPE THE FOLLOWING MATERIAL EXACTLY AS IT IS PRINTED, LINE FOR LINE AND PAGE FOR PAGE. INDENT THE PARAGRAPHS 5 SPACES FROM THE MARGIN. DOUBLE-SPACE.

With reference to the fishing industry, Mr. Hoover commented when he was Secretary of Commerce, "Blindly, without regard to the stability of the industry in our generation, without sense of responsibility to future generations, we are recklessly destroying our littoral fisheries--that is, the species of sea-food in our bays and adjacent to our coast, at a rate which promises the end in a generation unless we accomplish further reform." (How can we prove that we are superior to the savage?)

In the northern part of North America the fisheries are based on a rich combination of rivers, bays, and shallow off-shore banks. Of special importance are the Grand Banks of Newfoundland and the smaller banks of Labrador, New England, and New Jersey. Within a dozen years after Columbus had returned to Spain from his first voyage, the Newfoundland banks were known to the fishermen of the French provinces of Normandy and Brittany. Without question, the knowledge of these fishing banks made a greater sensation in Europe than the mere fact of the discovery of the new continent. At the time of the discovery, Europe was poorer than now, and a new food supply was important.

The fishing industry in that day was relatively more important than it is in the twentieth century. Fish was an essential food because practically the whole of Europe was Catholic, and even those who could afford meat observed many fast days upon which fish must be eaten in its place. For a century before the French made settlements in the St. Lawrence valley, scores of vessels sailed back and forth from France to these Newfoundland banks each year.

Before the First World War the Nova Scotia fishing industry had a catch of \$10,000,000 per year, which equalled that of Massachusetts, the leading state of the United States. The total Canadian catch (\$35,000,000 in 1921) was nearly double that of New England. Nova Scotia with her many good harbors partook somewhat of the character of Newfoundland but, though she caught nearly one-third of the fish of Canada, the warmer climate of this province enabled her people to engage, to a considerable extent, in agriculture. They also exported sheep, cattle, and horses across the straits to the people of Newfoundland.

Fishermen do not confine their catch to one type of fish. For example, cod fishermen also catch halibut and hake. The American catch of these fish is actually equal in value to the catch of cod. The cod thrives in cold waters and is, therefore, taken in greater quantity by Canadians than by New Englanders, and the people of Newfoundland and Labrador catch more codfish than all the

rest of the people of America. Dried cod makes up nearly two-thirds of the exports of this northern dependency of Great Britain.

Fish are like many of the other resources upon which our mechanical civilization depends. They are limited in numbers and rapidly declining. The difference lies in the fact that fish offer hope of restoration since their cycle is as follows: natural plenty, destruction by man, study of the situation, restoration by the application of science, and the control of this generation in the interest of the future. The latter two stages, unfortunately, require intelligence and the concept of racial welfare; the first is but slightly visible in larger human affairs, and the second is almost completely invisible at present.

One of the greatest resources which is not used extensively as yet is the sea. It covers three-fourths of the world's surface. It is the habitat of countless millions of minute plant organisms which are eaten by many small animals; these in turn are eaten by each other and by the smaller fish, and they in turn by the larger fish, and the whole pyramid of marine animal life, like that of land animals, is dependent upon vegetation for its existence.

There are two habits of fish which enable us to catch near the land those species that may have passed most of their lives hundreds of miles away at sea, and it is upon these habits that the world's fishing industry depends.

The first habit is that of spawning. Many species habitually

lay their eggs only in rivers or in the shallow waters near

the shore. The second habit is the congregation of fish at the ocean bottoms, in shallow waters, for feeding. These waters are commonly known as "banks." The greatest fishing regions are located where these banks occur in large numbers.

The term "fishery" refers to the catching of practically any animal that is taken from the water. This includes oysters, lobsters, whales, and even seals, which are often taken on shore.

I		
III		
TOTAL		

NAME _____

Approved For Release 1999/09/08 : CIA-RDP80-01826R001000010002-2

AGE _____ SEX _____ DATE _____

SYSTEM OF SHORTHAND USED _____

DATE STENOGRAPHIC TRAINING WAS COMPLETED _____

DICTIONATION SPEED _____ WORDS PER MINUTE YEARS OF STENOGRAPHIC EXPERIENCE _____

1. _____ 2. _____ 3. _____

RESTRICTED: Not to be shown to unauthorized persons in or out of the Army, or to be reproduced in whole or in part without authorization by the Office, Secretary of War.

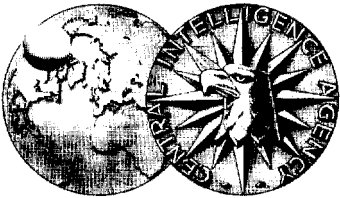

Shorthand Test

Form A

TESTING SECTION
PERSONNEL BRANCH
CENTRAL INTELLIGENCE AGENCY

Dear Sir:

Make all corrections in spaces below

1. _____ Recently I reviewed a copy of your letter which
2. _____ was addressed to an employee (---) the (---) of going
3. _____ into the insurance business. In my opinion, if a man
4. _____ has the proper (---) and is willing to invest a lot of
5. _____ (---) the (---) are good for success. I am happy
6. _____ to say you were (---) with our company and will
7. _____ (---) to (---) you in any way that is proper. Sincerely,

Approved For Release 1999/09/08 : CIA-RDP80-01826R001000010002-2

Gentlemen:

Every time a friend writes us about the (--) he 1. _____

is receiving from our (--) it makes us feel quite proud. 2. _____

If you are a dealer of (--) no doubt you (--) this 3. _____

feeling of pride. (--) however, we (--) that can 4. _____

in no way be considered (--) (--) to reports of 5. _____

many (--) some difficulties have been (--) in the (--) 6. _____

of our products. This problem, of course, is not ours 7. _____

alone. All (--) of (--) have expected similar (--) The 8. _____

problem is to (--) the quality of our stock and yet make 9. _____

an (--) to solve (--) in packing. If this (--) is not 10. _____

(--) by an (--) in (--) we shall (--) have a 11. _____

probable (--) to our (--) Please send (--) you 12. _____

want (--) to the board of directors. In all (--) 13. _____

if plans are not to become (--) to (--) action must be 14. _____

taken. If you have any (--) or (--) concerning (--) 15. _____

methods of (--) or (--) please send them before the 16. _____

(--) meeting of the (--) Yours truly, 17. _____

Make all corrections
in spaces below

Dear Sir: **Approved For Release 1999/09/08 : CIA-RDP80-01826R001000010002-2**

Now that the vacation season is at (--) you
 may be (--) some difficulty in (--) the proper
 place to visit. To (--) our many friends to (--)
 the most interesting (--) our company has (--)
 the enclosed booklet. For your convenience, all
 information is (--) under one cover which (--)
 the (--) of your going through an (--) of
 (--). We suggest you choose the (--) and then
 (--) us for (--) service. Of (--) immediate
 (--) is the necessity of (--). Already many of the
 more (--) are (--) to (--). Of course (--)
 reservations may be (--) after August 15. Our (--)
 is always (--). We (--) you with the (--) that
 everything (--) is (--) to (--) the best (--)
 under (--). Remember, our travel (--) for all
 (--). Let us (--) you a (--) place among our (--)
 and (--). If you are (--) interested in (--)
 or (--) merely (--) any of our (--) or formal

- 36. _____
- 37. _____
- 38. _____
- 39. _____
- 40. _____
- 41. _____
- 42. _____
- 43. _____
- 44. _____
- 45. _____
- 46. _____
- 47. _____
- 48. _____
- 49. _____
- 50. _____
- 51. _____
- 52. _____
- 53. _____

Approved For Release 1999/09/08 : CIA-RDP80-01826R001000010002-2

Dear Sir:

Enclosed you will find two letters which (--) should like you to read carefully (--) we want to have the (--) of your opinion of them. (--) are part of a (--) of eight which describe (--) the new (--) and products (--) in this area. We are keeping a record of all (--) as we receive them from our readers. A table will then be prepared in such form as to present a (--) picture of the (--) that have (--) as a (--) of (--). The (--) will be prepared by a (--) in his particular field and will (--) a special (--) and (--) of the results (--) from (--). Particular (--) will be presented upon (--) and especially (--) in this country.

With the cooperation of technical and (--) we plan to (--) this (--). We learn many (--) do (--) for (--) but this (--) of (--) is something entirely new. We feel certain

- 18. _____
- 19. _____
- 20. _____
- 21. _____
- 22. _____
- 23. _____
- 24. _____
- 25. _____
- 26. _____
- 27. _____
- 28. _____
- 29. _____
- 30. _____
- 31. _____
- 32. _____
- 33. _____
- 34. _____
- 35. _____

that the (--) will prove (--) and (--). Sincerely,

THIS TEST USED PRIMARILY IN FIELD
RECRUITING

RESTRICTED

Learning Ability Test

Form 5

**DO NOT MAKE ANY MARKS ON THIS BOOKLET
DO NOT OPEN UNTIL TOLD TO DO SO**

1944

RESTRICTED

RESTRICTED

DIRECTIONS

This test contains 90 questions. You will have 30 minutes in which to answer them. You may not be able to finish all of the questions in the time allowed, but do as many as you can. Your score on this test will be the number of answers you get right. There is no penalty for wrong answers. If you are not sure of the right answer to any question, make the best choice you can.

You have a special answer sheet on which to mark your answers. Do not fold or crease this answer sheet in any way. Do not write anything, or make marks of any kind, on the test booklet.

In answering the questions, read each question carefully; then read the four answers which follow it. Choose the correct answer and mark your answer in the proper place on the answer sheet. Always make sure that the number on the answer sheet agrees with the number of the question.

Here are some sample questions to show you how to mark your answers on the answer sheet.

1. A robin is a kind of
- A) fish
 - B) bird
 - C) reptile
 - D) insect

The right answer for question 1 is B). Now look at your answer sheet. After the number 1, there are four pairs of dotted lines labeled A, B, C, and D. A heavy mark has been made between the lines labeled B since the B answer is the right one for this question.

2. If one apple costs 5 cents, how many cents do three apples cost?
- A) 10
 - B) 5
 - C) 20
 - D) 15
3. Sky is related to blue just as grass is related to
- A) green
 - B) table
 - C) warm
 - D) big

Answer questions 2 and 3 by yourself. Read each question and its four possible answers. Decide which answer is the right one. Then, make a heavy black mark between the pair of dotted lines labeled the same as the answer you think is right. Be sure that the mark is heavy (make several strokes up and down with your pencil) and that it is no longer or wider than the space between the dotted lines. If you make a mistake, erase the mark. Be sure to erase thoroughly.

DO NOT TURN THIS PAGE UNTIL YOU ARE TOLD TO DO SO.

RESTRICTED

4. Ear is related to hear just as eye is related to
A) table
B) hand
C) see
D) play
5. If you make 7 engines a month for 4 months, how many engines will you have?
A) 11
B) 28
C) 3
D) 14
6. A small piece of sheet metal weighs 1 pound 2 ounces. A pile of eight of these pieces would weigh how many pounds?
A) 9
B) 24
C) 12
D) $1 \frac{1}{2}$
7. A man wishes to build a wooden box 4 feet square, having a bottom but no cover, with sides 2 feet high. How many square feet of lumber will he use?
A) 16
B) 24
C) 64
D) 48
8. To eliminate is to
A) unite
B) remove
C) adjust
D) fail
9. A foreman has 12 spare parts; he received 3 more from the stock room, and then used 6. How many spare parts did he have left?
A) 3
B) 6
C) 9
D) 12
10. Granary is to wheat as library is to
A) desk
B) books
C) paper
D) librarian
11. Which letter appears most often within a single word of the following sentence?

A large proportion of the world's surface is covered with water.

A) p
B) s
C) e
D) o
12. The ampere is used in measuring
A) wind power
B) electricity
C) water power
D) rainfall
13. Gun is related to shoots just as knife is related to
A) run
B) cuts
C) hats
D) bird
14. A word meaning the opposite of assemble is
A) join
B) disgrace
C) install
D) dismantle
15. Sand is to glass as clay is to
A) stone
B) hay
C) bricks
D) dirt
16. To make plans specific is to make them
A) detailed
B) possible
C) tentative
D) general

17. The Allison engine is used in the
 A) automobile
 B) motorcycle
 C) tank
 D) airplane
18. Peninsula is related to land as bay is related to
 A) boats
 B) river
 C) ocean
 D) Massachusetts
19. Cypress is a kind of
 A) machine
 B) food
 C) tree
 D) fabric
20. A word meaning the opposite of accept is
 A) permit
 B) receive
 C) reject
 D) take
21. If 241 squads of men are to dig 4097 yards of trench, how many yards must be dug by each squad?
 A) 61
 B) 14
 C) 27
 D) 17
22. Giant is to dwarf as large is to
 A) big
 B) monster
 C) queer
 D) small
23. December is to January as last is to
 A) least
 B) worst
 C) month
 D) first
24. Bombay is a city in
 A) China
 B) Egypt
 C) India
 D) Japan
25. Establish is to begin as abolish is to
 A) slavery
 B) wrong
 C) abolition
 D) end
26. Coral is obtained from
 A) mines
 B) elephants
 C) oysters
 D) reefs
27. The opposite of concave is
 A) concern
 B) obtuse
 C) conical
 D) convex
28. Gregg was most famous in
 A) physics
 B) shorthand
 C) railroading
 D) electricity
29. The bassoon is used in
 A) music
 B) stenography
 C) book-binding
 D) lithography
30. A six-sided figure is called a
 A) scholium
 B) parallelogram
 C) hexagon
 D) trapezium
31. A house that is adjacent to yours would be one that
 A) looks like yours
 B) is next door
 C) is across the street
 D) is the same size
32. To minimize is to
 A) prevent
 B) increase
 C) scrutinize
 D) lessen

33. Scrooge appears in
A) Vanity Fair
B) The Christmas Carol
C) Pickwick Papers
D) Henry IV
34. Bold is to timid as advance is to
A) proceed
B) retreat
C) campaign
D) soldier
35. A tendency is
A) a possibility
B) an inclination
C) a desire
D) an ability
36. If the following words were arranged to make a good sentence, with what letter would the last word of the sentence begin?

are wood made Many of desks

A) d
B) M
C) a
D) w
37. Maize is a kind of
A) corn
B) hay
C) oats
D) rice
38. Lion is to animal as rose is to
A) small
B) leaf
C) plant
D) thorn
39. Prerogative means most nearly
A) a question
B) a custom
C) a right
D) temperament
40. A commission house which had already supplied 1897 barrels of apples to a camp delivered the remainder of its stock to 29 mess halls. Each mess hall received 54 barrels. What was the total numbers of barrels supplied?
A) 1951
B) 3463
C) 1926
D) 1980
41. If there are more cars than countries in the following group, mark A; if not mark C.

Ford, Canada, Russia, Buick, England, Italy, Sweden, Chrysler, Chevrolet, Plymouth
42. A word meaning the opposite of former is
A) before
B) latter
C) above
D) earlier
43. A rectangular bin holds 400 cubic feet of lime. If the bin is 10 feet long and 5 feet wide, how many feet deep is it?
A) 4
B) 25
C) 8
D) 15
44. Pretty is to ugly as attract is to
A) fine
B) repel
C) nice
D) draw
45. The pancreas is in the
A) abdomen
B) head
C) shoulder
D) neck

46. A carpenter has a 12-foot board. How many cuts must he make to cut it into 3 equal parts?
- A) 1
 - B) 2
 - C) 3
 - D) 4

47. Quarrel is to enemy as agree is to
- A) friend
 - B) disagree
 - C) agreeable
 - D) foe

48. The author of The Raven is
- A) Stevenson
 - B) Kipling
 - C) Hawthorne
 - D) Poe

49. Which number of the following series is incorrect?

5 23 6 21 7 19 8 18
9 15 10 13

- A) 7
- B) 10
- C) 18
- D) 19

50. Eighteen widths of clapboard are needed to cover a wall 12 feet high. How many widths of clapboard are needed to cover a wall 20 feet high?

- A) 24
- B) 30
- C) 36
- D) 38

51. Spare is a term used in
- A) bowling
 - B) football
 - C) tennis
 - D) hockey

52. Emeralds are usually
- A) red
 - B) blue
 - C) green
 - D) yellow

53. One number in the following series is incorrect.

2 5 8 11 13 17 20 23 26 29

The incorrect number is

- A) 23
- B) 13
- C) 8
- D) 17

54. If the following words were arranged to make a good sentence, with which letter would the next to the last word begin?

certain some death of mean kinds
sickness

- A) c
- B) m
- C) s
- D) o

55. A stock-keeper is directed to send 32 percent of his stock of nails to a certain department. If he has 75 pounds of nails in his stock, how many pounds should he send?

- A) 23
- B) 34
- C) 24
- D) 2

56. The Battle of Gettysburg was fought in

- A) 1863
- B) 1813
- C) 1778
- D) 1812

57. An electrician is instructed to cut into 4 equal pieces a wire that is $10\frac{1}{3}$ feet long. How many inches long should each piece be?
- A) 30
 - B) 8
 - C) 31
 - D) 41

58. Which letter in the following sentence appears for a second time nearest the beginning?

Both milk and cream are beverages.

- A) m
- B) a
- C) b
- D) e

59. How many sixteenths of an inch are in a foot and one half?
- A) 16
 - B) 24
 - C) 192
 - D) 288

60. A word meaning the opposite of dissipate is
- A) facilitate
 - B) accumulate
 - C) accentuate
 - D) agitate

61. Apathy means the same as
- A) vagueness
 - B) sympathy
 - C) indifference
 - D) laziness

62. Count the number of states listed below

Florida, Alabama, Albany, Oregon,
Buffalo, Seattle, Indiana, Chicago,
Illinois, Detroit, Kentucky

The total number of states is

- A) 4
- B) 5
- C) 6
- D) 11

63. Some of the words in the following list are not in the correct alphabetical order. Which one is the first one out of order?

alto, bearing, beauty, black, crime, cringe, dilute, drum, enemy, emulate, flange, grind, heir, hear, hollow, iron

- A) beauty
- B) cringe
- C) enemy
- D) heir

64. The opposite of oppress is

- A) depress
- B) hurt
- C) uplift
- D) surge

65. Which of the following statements means most nearly the same as "Strike while the iron is hot"?

- A) Nothing ventured, nothing gained.
- B) Sail when the wind blows.
- C) Don't count your chickens before they are hatched.
- D) Better safe than sorry.

66. The most important reason for using cork for bottle stoppers is that

- A) it floats in liquids
- B) it is cheap
- C) it gives a tight fit
- D) it neutralizes bacteria

67. Town A is $3\frac{1}{4}$ inches from Town B on a map with a scale of 1 inch = 16 miles. To find the actual distance between the two towns, you should

- A) add
- B) subtract
- C) multiply
- D) divide

68. Effigy means most nearly

- A) image
- B) corpse
- C) ridicule
- D) apparition

69. It is harder to breathe at high altitudes because
- A) it is harder for the lungs to expel the heavy air
 - B) more poisonous gases have drifted up from lower altitudes
 - C) it is difficult to adjust to the decreased oxygen content of the air
 - D) the relative humidity is greater at higher altitudes.

70. Census figures show that the death rate among married persons is lower than among unmarried persons in the same age group. This proves that
- A) marriage causes persons to live longer
 - B) census figures are sometimes misleading
 - C) more unmarried persons die than married persons of the same age
 - D) none of the above conclusions follow

71. Inherently means most nearly
- A) naturally
 - B) primarily
 - C) completely
 - D) externally

72. Fanaticism means most nearly
- A) fantasy
 - B) zealotry
 - C) partisanship
 - D) vitality

73. Rescinded means most nearly
- A) amplified
 - B) canceled
 - C) modified
 - D) delayed

74. What letter would come next in this series?

G A R H B S I

- A) T
- B) C
- C) J
- D) N

75. Assume the following to be true:

- A is equal to B
- B is greater than C
- C is less than D
- D is less than E
- C is equal to F

Then, it follows that

- A) D is less than A
- B) D is equal to A
- C) D is greater than A
- D) D may or may not be greater than A

76. It also follows that

- A) A is less than F
- B) A is greater than F
- C) A is equal to F
- D) A may or may not be greater than F

77. If some employees of a company are women, and most of the employees are efficient workers, it follows that

- A) the inefficient workers are women
- B) some women are efficient workers
- C) most women in this company are efficient workers
- D) none of these conclusions follow

78. A flying buttress is a part of

- A) an airline staff
- B) a football play
- C) a Gothic building
- D) a climbing vine

79. A cube which is painted on two adjacent sides is divided into 8 smaller cubes, all of equal size. The number of smaller cubes having only one painted side is

- A) 4
- B) 6
- C) 0
- D) 8

30. The fifth letter in the alphabet to the right of the letter half-way between h and l is
 A) o
 B) q
 C) e
 D) n
81. If 240 ounces of meat last 7 days for 6 men, how many ounces per day are rationed to each man?
 A) 40
 B) .57
 C) 6.1
 D) $5\frac{5}{7}$
82. Predisposition means about the same as
 A) susceptibility
 B) foresight
 C) prevalence
 D) persuasion
83. Three draft boards are ordered to furnish a total of 400 men. Board 1 has 2,300 men registered with it, Board 2 has 1,600, and Board 3 has 1,100. If each board supplied a number of men proportional to the number registered, Board 2 will supply
 A) 128 men
 B) 88 men
 C) 160 men
 D) 40 men
84. A purchasing department can buy either of two grades of a certain part. Grade A costs \$2.40 and has an average life of 8 months; Grade B costs \$3.20 and has an average life of 1 year. It follows that
 A) the two grades are equally economical purchases
 B) Grade A is slightly more economical
 C) Grade B is slightly more economical
 D) in the long run, Grade A parts would cost twice as much as Grade B
85. To be amenable is to be
 A) tractable
 B) likable
 C) humble
 D) gullible
86. If you know the perimeter of a square, and wish to find its area, you would
 A) divide and square
 B) take the square root and multiply
 C) take the square root and add
 D) subtract and multiply
87. All mugwumps are catbirds. All catbirds are corny. Some stopgaps are mugwumps. Only dugongs are stopgaps. Therefore some dugongs must be corny.
 If the first four statements are true, the conclusion
 A) is probably false
 B) is certainly true
 C) does not follow from the statements
 D) is certainly false
88. Sporadic means most nearly
 A) vigorous
 B) occasional
 C) convivial
 D) feverish
89. Salient means most nearly
 A) bitter
 B) eccentric
 C) controversial
 D) prominent
90. A and B can finish a job in 6 days. A and C can finish the same job in 4 days. A works twice as fast as B. The time it would take B and C to finish the job is most likely
 A) more than 6 days
 B) between 4 and 6 days
 C) less than 4 days
 D) one cannot say

RESTRICTED

91. Epitome means most nearly

- A) a large book
- B) a sinecure
- C) an abridgement
- D) a eulogy

93. Descry means most nearly

- A) explain
- B) scorn
- C) espy
- D) dislike

92. A dealer decreased the price of a certain article by 20 percent, and as a result the quantity of the article which he sold increased by 30 percent. By what percent did his gross income increase or decrease?

- A) 10%
- B) 30%
- C) 4%
- D) 6%

By ARTHUR S. OTIS

Formerly Development Specialist with Advisory Board, General Staff, United States War Department

HIGHER EXAMINATION: FORM A

For High Schools and Colleges

Score.....

20

Read this page. Do what it tells you to do.

Do not open this paper, or turn it over, until you are told to do so. Fill these blanks, giving your name, age, birthday, etc. Write plainly.

Name..... Age last birthday..... years
First name, initial, and last name

Birthday..... Class..... Date..... 19.....
Month Day

School or College..... City.....

This is a test to see how well you can think. It contains questions of different kinds. Here is a sample question already answered correctly. Notice how the question is answered:

Which one of the five words below tells what an apple is?
1 flower, 2 tree, 3 vegetable, 4 fruit, 5 animal..... (4)

The right answer, of course, is "fruit"; so the word "fruit" is underlined. And the word "fruit" is No. 4; so a figure 4 is placed in the parentheses at the end of the dotted line. This is the way you are to answer the questions.

Try this sample question yourself. Do not write the answer; just draw a line under it and then put its number in the parentheses:

Which one of the five words below means the opposite of north?
1 pole, 2 equator, 3 south, 4 east, 5 west..... ()

The answer, of course, is "south"; so you should have drawn a line under the word "south" and put a figure 3 in the parentheses. Try this one:

A foot is to a man and a paw is to a cat the same as a hoof is to a — what?
1 dog, 2 horse, 3 shoe, 4 blacksmith, 5 saddle..... ()

The answer, of course, is "horse"; so you should have drawn a line under the word "horse" and put a figure 2 in the parentheses. Try this one:

At four cents each, how many cents will 6 pencils cost?..... ()

The answer, of course, is 24, and there is nothing to underline; so just put the 24 in the parentheses. If the answer to any question is a number or a letter, put the number or letter in the parentheses without underlining anything. Make all letters like printed capitals.

The test contains 75 questions. You are not expected to be able to answer all of them, but do the best you can. You will be allowed half an hour after the examiner tells you to begin. Try to get as many right as possible. Be careful not to go so fast that you make mistakes. Do not spend too much time on any one question. No questions about the test will be answered by the examiner after the test begins. Lay your pencil down.

Do not turn this page until you are told to begin.

PRINTED IN U.S.A.

Published by World Book Company, Yonkers-on-Hudson, New York, and 2126 Prairie Avenue, Chicago
Copyright 1922 by World Book Company. Copyright in Great Britain. All rights reserved. OSATMA:HE:A-23

This test is copyrighted. The reproduction of any part of it by mimeograph, hectograph, or in any other way, whether the reproductions are sold or are furnished free for use, is a violation of the copyright law.

EXAMINATION BEGINS HERE:

1. The opposite of hate is (?)
1 enemy, 2 fear, 3 love, 4 friend, 5 joy..... ()
2. If 3 pencils cost 5 cents, how many pencils can be bought for 50 cents?..... ()
3. A bird does not always have (?)
1 wings, 2 eyes, 3 feet, 4 a nest, 5 a bill..... ()
4. The opposite of honor is (?)
1 glory, 2 disgrace, 3 cowardice, 4 fear, 5 defeat..... ()
5. A fox most resembles a (?)
1 wolf, 2 goat, 3 pig, 4 tiger, 5 cat..... ()
6. Quiet is related to sound in the same way that darkness is related to (?)
1 a cellar, 2 sunlight, 3 noise, 4 stillness, 5 loud..... ()
7. A party consisted of a man and his wife, his two sons and their wives, and four children in each son's family. How many were there in the party?..... ()
8. A tree always has (?)
1 leaves, 2 fruit, 3 buds, 4 roots, 5 a shadow..... ()
9. The opposite of economical is (?)
1 cheap, 2 stingy, 3 extravagant, 4 value, 5 rich..... ()
10. Silver is more costly than iron because it is (?)
1 heavier, 2 scarcer, 3 whiter, 4 harder, 5 prettier..... ()
11. Which one of the six statements below tells the meaning of the following proverb? "The early bird catches the worm."..... ()
 1. Don't do the impossible.
 2. Weeping is bad for the eyes.
 3. Don't worry over troubles before they come.
 4. Early birds like worms best.
 5. Prompt persons often secure advantages over tardy ones.
 6. It is foolish to fret about things we can't help.
12. Which statement above tells the meaning of this proverb? "Don't cry over spilt milk.".... ()
13. Which statement above explains this proverb? "Don't cross a bridge till you get to it.".... ()
14. An electric light is related to a candle as an automobile is to (?)
1 a carriage, 2 electricity, 3 a tire, 4 speed, 5 glow..... ()
15. If a boy can run at the rate of 6 feet in $\frac{1}{4}$ of a second, how many feet can he run in 10 seconds? ()
16. A meal always involves (?)
1 a table, 2 dishes, 3 hunger, 4 food, 5 water..... ()
17. Of the five words below, four are alike in a certain way. Which is the one not like these four?
1 bend, 2 shave, 3 chop, 4 whittle, 5 shear..... ()
18. The opposite of never is (?)
1 often, 2 sometimes, 3 occasionally, 4 always, 5 frequently..... ()
19. A clock is related to time as a thermometer is to (?)
1 a watch, 2 warm, 3 a bulb, 4 mercury, 5 temperature..... ()
20. Which word makes the truest sentence? Men are (?) shorter than their wives.
1 always, 2 usually, 3 much, 4 rarely, 5 never..... ()
21. One number is wrong in the following series. What should that number be?
1 4 2 5 3 6 4 7 5 9 6 9..... ()
22. If the first two statements following are true, the third is (?) All members of this club are Republicans. Smith is not a Republican. Smith is a member of this club.
1 true, 2 false, 3 not certain..... ()
23. A contest always has (?)
1 an umpire, 2 opponents, 3 spectators, 4 applause, 5 victory..... ()
24. Which number in this series appears a second time nearest the beginning?
6 4 5 3 7 8 0 9 5 9 8 8 6 5 4 7 3 0 8 9 1..... ()
25. The moon is related to the earth as the earth is to (?)
1 Mars, 2 the sun, 3 clouds, 4 stars, 5 the universe..... ()
26. Which word makes the truest sentence? Fathers are (?) wiser than their sons.
1 always, 2 usually, 3 much, 4 rarely, 5 never..... ()

27. The opposite of awkward is (?)
 1 strong, 2 pretty, 3 short, 4 graceful, 5 swift. ()
28. A mother is always (?) than her daughter.
 1 wiser, 2 taller, 3 stouter, 4 older, 5 more wrinkled. ()
29. Which one of the six statements below tells the meaning of the following proverb? "The burnt child dreads the fire." ()
 1. Frivolity flourishes when authority is absent.
 2. Unhappy experiences teach us to be careful.
 3. A thing must be tried before we know its value.
 4. A meal is judged by the dessert.
 5. Small animals never play in the presence of large ones.
 6. Children suffer more from heat than grown people.
30. Which statement above explains this proverb? "When the cat is away, the mice will play." ()
31. Which statement above explains this proverb? "The proof of the pudding is in the eating." ()
32. If the settlement of a difference is made by mutual concession, it is called a (?) .
 1 promise, 2 compromise, 3 injunction, 4 coercion, 5 restoration. ()
33. What is related to disease as carefulness is to accident?
 1 doctor, 2 surgery, 3 medicine, 4 hospital, 5 sanitation. ()
34. Of the five things below, four are alike in a certain way. Which is the one not like these four?
 1 smuggle, 2 steal, 3 bribe, 4 cheat, 5 sell. ()
35. If 10 boxes full of apples weigh 400 pounds, and each box when empty weighs 4 pounds, how many pounds do all the apples weigh? ()
36. The opposite of hope is (?)
 1 faith, 2 misery, 3 sorrow, 4 despair, 5 hate. ()
37. If all the odd-numbered letters in the alphabet were crossed out, what would be the tenth letter not crossed out? Print it. *Do not mark the alphabet.*
 A B C D E F G H I J K L M N O P Q R S T U V W X Y Z. ()
38. What letter in the word SUPERFLUOUS is the same number in the word (counting from the beginning) as it is in the alphabet? Print it. ()
39. What people say about a person constitutes his (?)
 1 character, 2 gossip, 3 reputation, 4 disposition, 5 personality. ()
40. If $2\frac{1}{2}$ yards of cloth cost 30 cents, how many cents will 10 yards cost? ()
41. If the words below were arranged to make a good sentence, with what letter would the second word of the sentence begin? Make it like a printed capital.
 same means big large the as. ()
42. If the first two statements following are true, the third is (?) George is older than Frank. James is older than George. Frank is younger than James.
 1 true, 2 false, 3 not certain. ()
43. Suppose the first and second letters in the word CONSTITUTIONAL were interchanged, also the third and fourth letters, the fifth and sixth, etc. Print the letter that would then be the twelfth letter counting to the right. ()
44. One number is wrong in the following series. What should that number be?
 0 1 3 6 10 15 21 28 34. ()
45. If $4\frac{1}{2}$ yards of cloth cost 90 cents, how many cents will $2\frac{1}{2}$ yards cost? ()
46. A man's influence in a community should depend upon his (?)
 1 wealth, 2 dignity, 3 wisdom, 4 ambition, 5 political power. ()
47. What is related to few as ordinary is to exceptional?
 1 none, 2 some, 3 many, 4 less, 5 more. ()
48. The opposite of treacherous is (?)
 1 friendly, 2 brave, 3 wise, 4 cowardly, 5 loyal. ()
49. Which one of the five words below is most unlike the other four?
 1 good, 2 large, 3 red, 4 walk, 5 thick. ()
50. If the first two statements following are true, the third is (?) Some of Brown's friends are Baptists. Some of Brown's friends are dentists. Some of Brown's friends are Baptist dentists.
 1 true, 2 false, 3 not certain. ()
51. How many of the following words can be made from the letters in the word LARGEST, using any letter any number of times?
 great, stagger, grasses, trestle, struggle, rattle, garage, strangle. ()
52. The statement that the moon is made of green cheese is (?)
 1 absurd, 2 misleading, 3 improbable, 4 unfair, 5 wicked. ()

S. A. Highes: A

53. Of the five things following, four are alike in a certain way. Which is the one not like these four?
1 tar, 2 snow, 3 soot, 4 ebony, 5 coal..... ()
54. What is related to a cube in the same way in which a circle is related to a square?
1 circumference, 2 sphere, 3 corners, 4 solid, 5 thickness..... ()
55. If the following words were seen on a wall by looking in a mirror on an opposite wall, which word would appear exactly the same as if seen directly?
1 OHIO, 2 SAW, 3 NOON, 4 MOTOR, 5 OTTO..... ()
56. If a strip of cloth 24 inches long will shrink to 22 inches when washed, how many inches long will a 36-inch strip be after shrinking?..... ()
57. Which of the following is a trait of character?
1 personality, 2 esteem, 3 love, 4 generosity, 5 health..... ()
58. Find the two letters in the word DOING which have just as many letters between them in the word as in the alphabet. Print the one of these letters that comes first in the alphabet.
A B C D E F G H I J K L M N O P Q R S T U V W X Y Z..... ()
59. Revolution is related to evolution as flying is to (?)
1 birds, 2 whirling, 3 walking, 4 wings, 5 standing..... ()
60. One number is wrong in the following series. What should that number be?
1 3 9 27 81 108..... ()
61. If Frank can ride a bicycle 30 feet while George runs 20 feet, how many feet can Frank ride while George runs 30 feet?..... ()
62. Count each N in this series that is followed by an O next to it if the O is not followed by a T next to it. Tell how many N's you count.
N O N T Q M N Q T M O N O O N Q M N N O Q N O T O N A M O N O M..... ()
63. A man who is averse to change and progress is said to be (?)
1 democratic, 2 radical, 3 conservative, 4 anarchistic, 5 liberal..... ()
64. Print the letter which is the fourth letter to the left of the letter which is midway between O and S in the alphabet..... ()
65. What number is in the space which is in the rectangle and in the triangle but not in the circle? ()

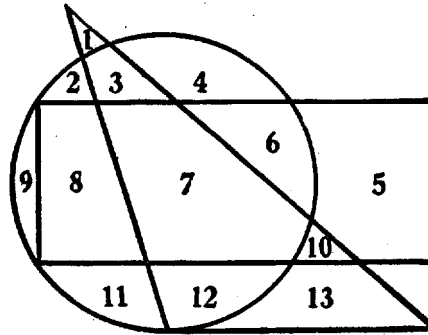

66. What number is in the same geometrical figure or figures as the number 8?..... ()
67. How many spaces are there that are in any two but only two geometrical figures?..... ()
68. A surface is related to a line as a line is to (?)
1 solid, 2 plane, 3 curve, 4 point, 5 string..... ()
69. If the first two statements following are true, the third is (?) One cannot become a good violinist without much practice. Charles practices much on the violin. Charles will become a good violinist.
1 true, 2 false, 3 not certain..... ()
70. If the words below were arranged to make the best sentence, with what letter would the last word of the sentence end? Print the letter as a capital.
sincerity traits courtesy character of desirable and are..... ()
71. A man who is influenced in making a decision by preconceived opinions is said to be (?)
1 influential, 2 prejudiced, 3 hypocritical, 4 decisive, 5 impartial..... ()
72. A hotel serves a mixture of 2 parts cream and 3 parts milk. How many pints of cream will it take to make 15 pints of the mixture?..... ()
73. What is related to blood as physics is to motion?
1 temperature, 2 veins, 3 body, 4 physiology, 5 geography..... ()
74. A statement the meaning of which is not definite is said to be (?)
1 erroneous, 2 doubtful, 3 ambiguous, 4 distorted, 5 hypothetical..... ()
75. If a wire 20 inches long is to be cut so that one piece is $\frac{2}{3}$ as long as the other piece, how many inches longer must the shorter piece be?..... ()

GENERAL TEST I

DIRECTIONS

This test contains 80 questions. You will have one hour in which to answer them. You may not be able to finish all of the questions in the time allowed, but do as many as you can. Your score on this test will be the number of answers you get right. There is no penalty for wrong answers. If you are not sure of the right answer to any question, make the best choice you can.

You have a special answer sheet on which to mark your answers. Do not fold or crease this answer sheet in any way. Do not write anything, or make marks of any kind, on the test booklet.

In answering the questions, read each question carefully; then read the five answers which follow it. Choose the correct answer and mark your answer in the proper place on the answer sheet. Always make sure that the number on the answer sheet agrees with the number of the question.

Here are some sample questions to show you how to mark your answers on the answer sheet.

1. A robin is a kind of
 - A) fish
 - B) bird
 - C) reptile
 - D) insect
 - E) plant

The right answer for question 1 is B). Now look at your answer sheet. After the number 1, there are five pairs of dotted lines labeled A, B, C, D, and E. A heavy mark has been made between the lines labeled B since the B answer is the right one for this question.

2. If one apple costs 5 cents, how many cents do three apples cost?
 - A) 10
 - B) 5
 - C) 20
 - D) 15
 - E) 25
3. Sky is related to blue just as grass is related to
 - A) green
 - B) table
 - C) warm
 - D) big
 - E) tree

Answer questions 2 and 3 by yourself. Read each question and its five possible answers. Decide which answer is the right one. Then, make a heavy black mark between the pair of dotted lines labeled the same as the answer you think is right. Be sure that the mark is heavy (make several strokes up and down with your pencil) and that it is no longer or wider than the space between the dotted lines. If you make a mistake, erase the mark. Be sure to erase thoroughly.

The questions need not be taken up in order. Answer those first that you can answer without any delay. Then use the remainder of the hour allowed on the questions you have passed over.

Select the BEST ANSWER, and blacken the space on the Answer Sheet that bears the same letter as the answer. Do not write in this booklet.

4. DESIST means most nearly (A) annoy (B) stop (C) persevere (D) forbid (E) resume.

CAUTION.--RECORD YOUR ANSWERS ON THE SPECIAL ANSWER SHEET.

5. (Reading) "There are today four general methods of water purification: storage, slow sand filtration, rapid filtration with use of chemicals, and disinfection (usually with chlorine). By these methods, used alone or in combination, polluted water may be made safe even for drinking purposes."

According to the quotation, polluted water (A) can be detected in several different ways (B) requires complex methods for purification (C) can be purified best with chlorine (D) is the result of chemical action (E) is capable of being purified.

6. Of the following, the CHIEF reason why vitamins are sometimes added to foods is that (A) an adequate supply of vitamins is essential to good health (B) vitamins are most beneficial when they are consumed in food (C) such an addition imparts a special flavor to foods (D) no foods are supplied by nature with enough vitamins (E) vitamins in an unadulterated state cannot be consumed safely.

7. (Reading) "Better housing, better zoning laws, systems of transportation that open up new residential districts in urban areas, better roads in remote rural districts, improvements in agriculture and in the handling of foods--all of these may promote health as truly as a full-time health department."

According to the quotation, good health (A) can best be attained by indirect methods (B) can be fostered by a number of means (C) results in the improvement of general living conditions (D) is less general in rural than in urban areas (E) can be promoted best by a public health department.

8. ATHWART means most nearly (A) parallel (B) below (C) across (D) perpendicular (E) around.

9. (Reading) "Modern transportation facilities vastly increase the danger of diffusion of communicable disease; the speed and complexity of modern industry involve accident and poison hazards of the gravest sort, and the entire pace of modern life places upon the physical and mental machine an enormous strain."

According to the quotation, the modern mode of life (A) makes physical and mental breakdowns more common than they were years ago (B) is responsible for a great increase in the spread of disease (C) forces society to wage a losing battle against industrial hazards (D) cannot be advanced unless the public health is protected (E) increases the difficulty of maintaining good health.

10. In many shops, a signed copy of the labor contract between union members and their employers is conspicuously posted. Of the following, the CHIEF reason for such a custom is that (A) the terms of the contract may be readily accessible to all workers in the shops (B) visitors may observe at once that the shops are unionized (C) employees will remain satisfied with the conditions under which they work (D) employees may study the contract for the purpose of making the next one better (E) an ever-present consciousness of the contract makes its enforcement certain.
11. ENCUMBER means most nearly (A) enrage (B) contradict (C) obstruct (D) attach (E) surround.
12. The Post Office Department locates post-office stations in some large department stores CHIEFLY in order to (A) encourage post-office patrons to become store patrons also (B) serve as a convenience for patrons of the Service (C) provide economical working quarters for postal employees (D) save the stores' time and effort in shipping packages to patrons (E) popularize special as well as ordinary post-office functions.
13. Of the following, the CHIEF value of zoning ordinances is that they (A) correct all errors resulting from a lack of town planning (B) compel the decentralization of business to make shopping equally convenient in all sections (C) insure the continual increase of residential real estate values (D) regulate the use of land for the greatest good of the community as a whole (E) prevent the charging of high rents in neighborhoods under their control.
14. BANAL means most nearly (A) commonplace (B) forceful (C) tranquil (D) forbidden (E) indifferent.
15. (Reading) "Animal groups are undoubtedly dominated by heredity or instinct. Human society, on the other hand, is characterized from its earliest beginnings by acquired uniformities due to habit." According to the quotation, animals (A) are more uniform than are men in their behavior (B) act instinctively until they begin to act from habit (C) differ from men in the basis of their actions (D) possess many of the characteristics found in human beings (E) are affected by heredity whereas men are not.
16. The periodic taking of a census is ESPECIALLY necessary in a country having a representative form of government CHIEFLY because (A) prosperity depends largely upon the size of the domestic market (B) all qualified citizens have the right to vote (C) unemployment cannot be corrected if its extent is unknown (D) the best use of resources demands statistics concerning them (E) representation is based on population.
17. VAUNT means most nearly (A) ridicule (B) sneer (C) boast (D) insult (E) tease.

18. (Reading) "The Federal Government has not the power to pass and enforce laws upon every matter that concerns the general welfare of the people, but it has the power to raise money by taxation and to expend it in order to provide for the common defense and the general welfare of the United States."

The quotation indicates that the public welfare (A) is not the primary function of the Federal Government (B) depends on the local enforcement of existing laws (C) is best promoted by provision for the common defense (D) is not entirely under the jurisdiction of the Federal Government (E) is not usually the purpose for which local taxes are levied.

19. Three-lane highways are MORE LIKELY to be dangerous in hilly than in level country because (A) head-on collisions cause most of the fatal motor accidents in the Nation (B) heavy trucks often get out of control while descending steep hills (C) there is a tendency for through highways to encourage excessive speed (D) traffic from each direction must use the center lane for passing (E) dangerous intersections occur where such highways are crossed by side roads.

20. (Reading) "At one time the status of labor in this country was greatly affected by the influence of immigration on the labor supply. During the World War, however, immigration virtually ceased, and in recent years the number of emigrant departures has often exceeded that of immigrant admissions."

According to the quotation, the present supply of labor in this country (A) has discouraged foreigners from settling here in recent years (B) has not recently been increased by the migration of workers (C) would be affected little by the discontinuance of immigration (D) is great enough to meet any sudden demand on it (E) has been increased by an excess of immigrants over emigrants.

21. NEGATION means most nearly (A) avoidance (B) denial (C) dread (D) carelessness (E) regret.

22. (Reading) "Notwithstanding the difference in housing expenditures by families within the same income group, the amount spent for shelter is usually related to the income. In all areas housing is a substantial item in family budgets, varying at the lower income levels from 15 to 25 percent of total expenditures."

According to the quotation, expenditures for shelter (A) usually vary in some degree according to income (B) consume too large a share of the average income (C) vary considerably in different sections of the country (D) are usually small in comparison with total expenses (E) do not vary with the same income group.

23. Of the following, the CHIEF factor tending to discourage the individual ownership of automobiles by residents of large cities is (A) the recent tendency toward the decentralization of the population of large cities (B) transit problems in large cities arising from the over-crowding of public transportation facilities at rush hours (C) the high cost of delivering cars to widely scattered markets from automobile manufacturing centers (D) traffic hindrances and the high cost of garage and parking space (E) the great distances that residents of large cities must travel in order to reach resort areas.

24. COMMENSURATE means most nearly (A) unsuitable (B) moderate
(C) proportionate (D) irregular (E) justifiable
25. (Reading) "All our water power, including both that already developed and that feasible of development, could produce energy annually equivalent to only about one-fourth of the energy contained in all mineral fuels consumed in this country in 1937 for all purposes. Thus it is evident that water power can supply only a fraction of our energy requirements and that mineral fuels must bear the main burden."
According to the quotation, our water-power resources (A) cannot produce power that is adaptable to all types of uses (B) have been developed almost to their full extent (C) are used to supplement our nearly exhausted fuel resources (D) could not possibly supply all our energy requirements (E) are capable of producing four times their present energy output.
26. REPLETE means most nearly (A) abounding (B) destitute (C) burdensome
(D) empty (E) defective.
27. (Reading) "The characteristics of any machine can be roughly grouped into its structural characteristics and its operating characteristics. So long as a machine runs well, its operating characteristics are all-important and its structure can be largely taken for granted. But when the machine fails to operate properly, a knowledge of its essential structure is necessary in order to make the appropriate adjustments."
According to the quotation, the making of adjustments on a machine (A) is seldom necessary while it is still new (B) is the best way of learning how it operates (C) requires practical information as to its makeup (D) is often possible while it is in operation (E) necessarily requires skill in the operation of the machine.
28. Of the following, the CHIEF reason why suburban areas adjacent to large cities usually have fewer public institutions than have independent towns of equal size is that (A) the average income in suburbs tends to be relatively low (B) the city performs part of the community functions of suburban areas (C) towns of moderate size have less need for cooperative activities than do suburbs (D) restrictions on building sometimes prevent their construction in suburban areas (E) social problems are more acute in large cities than in small towns.
29. JEOPARDY means most nearly (A) indecision (B) danger (C) jealousy
(D) surprise (E) bewilderment.
30. (Reading) "With the consolidation by transcontinental railroad systems of the market of the United States, a market with apparently limitless demands for both capital goods and consumer goods was created, and a previously uneconomical degree of mass selling and large-scale production became practicable."
According to the quotation, the establishment in this country of far-flung railroad lines (A) greatly decreased local consumption of locally produced goods (B) increased the per capita demand for consumer goods (C) fostered the growth of large manufacturing industries (D) was made possible by the size of the market for industrial products (E) followed

31. Of the following factors, which one would be MOST LIKELY to result in a widely scattered geographical distribution of the shipbuilding industry?
(A) The materials needed for making ships change as the industry develops.
(B) skilled labor is concentrated in highly industrialized areas (C) ships can be easily transported from the centers of most economical production
(D) the development of specialized uses for ships has multiplied the variety of types built (E) there is likely to be a demand for ships wherever navigable rivers and accessible ports exist.
32. (Reading) "Usually Federal prisoners found to be mentally ill, tuberculous, or infirm are transferred to the medical center regardless of the type of supervision required. Since some of them may have definite destructive and escape tendencies, there should be an adequate number of men for each shift on each floor of the medical building."
According to the quotation, the fact that Federal prisoners are ill (A) alters the amount of supervision they should receive (B) is sometimes the result of improper treatment (C) makes their early release inadvisable (D) does not lessen the need for alert guards (E) lessens their tendency to attempt to escape.
33. (Reading) "The attention given to the physical and vocational restoration of disabled soldiers and sailors led to the belief that methods capable of restoring war victims to economic efficiency would prove equally effective in the case of victims of industrial accident and disease."
The quotation indicates that (A) industrial accidents disable more persons than does war (B) there are effective methods of making disabled persons again employable (C) the cure of physical injuries must precede vocational restoration (D) war ceases to be a liability when its victims become self-supporting (E) the effects of accidents are more serious than are those of disease.
34. SANGUINE means most nearly (A) despondent (B) noisy (C) dormant (D) reckless (E) confident.
35. Of the following, the MOST REASONABLE explanation of the fact that the fiscal year of the United States Government begins July 1st, instead of in January, is in order that (A) the celebration of January 1 as a national holiday may in no way be interrupted (B) Government departments may use an otherwise slack season in which to balance their books (C) it may coincide with the date used for the fiscal year by other countries (D) Congress, which convenes in January, may have time to act on new bills before the next Government year opens (E) new taxes may be levied to cover new appropriations.
36. (Reading) "The rigidity of quarantine varies with the disease. Moderate regulations generally enforced are far more effective than unduly severe ones that are unenforceable."
According to the quotation, quarantine regulations should be (A) severe (B) practicable (C) uniform (D) changed (E) posted.

37. (Reading) "The importance of the political machine lies in the fact that active popular interest is essentially episodic and that, except in those rare moments when a sense of crisis prevails, the winning of an election depends on stimulating apathetic voters to participate."
According to the quotation, political machines (A) serve to keep a people disunited (B) try to allay popular mistrust (C) are beneficial only to politicians (D) encourage active participation in elections (E) generally originate during times of emergency.
38. Imports into a country will greatly increase during the period between the enactment of tariff legislation and the date of its becoming operative CHIEFLY when (A) rates are to be increased (B) prices in that country are falling (C) fewer goods are to be taxed (D) the period of uncertainty is long (E) rates are to be lowered.
39. OCCULT means most nearly (A) injurious (B) awesome (C) irrational (D) secret (E) obvious.
40. (Reading) "A sharp distinction is often drawn between invention and discovery. The former is defined as an active combination of elements into a new form, and the latter as a passive perception of the existing relations of such elements."
According to the quotation, the distinction often made between inventions and discoveries is that the process resulting in the former is (A) creative (B) accidental (C) inevitable (D) spontaneous (E) significant.
41. RECAPITULATE means most nearly (A) surrender (B) debate (C) reinstate (D) interpret (E) summarize.
42. In more than half of the States, certain building and loan associations are exempt from the payment of State income taxes. This exemption is allowed CHIEFLY because such associations (A) provide the public with the safest channel for investing its money (B) strive to maintain construction activities at a steady level (C) have a favorable effect on local real estate business (D) often have members residing outside the geographical limits of the State (E) are operated for mutual benefit and without profit.
43. (Reading) "Since business profits in modern industry may sometimes be obtained at the expense of industrial efficiency, it is not necessarily true that the most profitable managerial policies from the standpoint of the individual firm are the most desirable from the standpoint of social interest."
According to the quotation, the profits of an individual firm (A) cannot remain high if efficiency continues to be neglected (B) are not always an indication of the prosperity of the individual business (C) are of primary importance to most managers (D) do not necessarily provide a reliable measure of efficiency (E) when excessive have a harmful effect on society.
44. REPERCUSSION means most nearly (A) retrogression (B) destruction (C) redress (D) reverberation (E) expansion.

45. General stores are the usual retail agencies for sparsely settled regions CHIEFLY because under such conditions (A) one agency must supply varied needs (B) people produce for themselves most of what they consume (C) demand is not so varied as it is in cities (D) a large variety of products is produced (E) a large proportion of buying is done by mail.
46. (Reading) "The demands made upon a government for services, which are a measure of its monetary requirements, are in direct relation to the social and economic development of the people living under the government; indeed, these demands increase in proportion to the general advancement attained by that people in the use of the technical arts and sciences."
According to the quotation, demands for government services (A) increase as the funds available to the government increase (B) indicate that the general public lacks self-reliance (C) generally operate to hasten social progress (D) decrease upon the improvement of general economic conditions (E) denote the stage of development reached by the public.
47. (Reading) "The shift from a money to a credit economy freed economic activity from concern over the availability of precious metals for use as money and substituted therefor the transfer of claims between buyer and seller, creditor and debtor, on the books of financial institutions."
The quotation implies that a credit economy (A) was adopted because precious metals became unavailable (B) created as many problems as it solved (C) gave rise to disputes between creditors and debtors (D) tended to stimulate economic activity (E) is not a permanent solution of current monetary problems.
48. The number of urban families exceeds the number of rural families by a larger proportion than the excess of urban population over rural population. Of the following, the MOST LIKELY explanation of this fact is that (A) the farm families average larger in size (B) the urban census is not accurate (C) many rural families have moved to cities (D) population is most dense in industrial areas (E) some urban families own rural property.
49. SALIENT means most nearly (A) primary (B) disastrous (C) subordinate (D) conspicuous (E) insignificant.
50. Of the following factors, which one is MOST LIKELY to cause variations in the price of the same commodity in different localities? (A) Uniform supply (B) unrestricted competition (C) poor transportation facilities (D) equalized demand (E) unequal size of population.
51. (Reading) "Conscious and organized welfare work is common only in large industrial organizations where personal contacts are least intimate, where the problem of winning individual interest and good will is more difficult because the unfavorable forces of mass psychology find free play, and where the per capita cost of such work may be distributed over a large output."
The quotation implies that organized welfare work in industry (A) cannot serve as a substitute for personal contacts among employees (B) increases in per capita cost as the size of the industry increases (C) is designed to secure the loyalty and the good will of employees (D) is most effective where it is made least obtrusive (E) greatly increases the per capita output of an industrial organization.

52. (Reading) "While an adverse environment may mean a limitation or a restriction of human existence and may reach the extent of making it impossible, a favorable environment can present only possibilities, which, however promising, may frequently not be used to advantage." According to the quotation, environment (A) can hamper, though it cannot foster, human existence (B) ordinarily has little effect on human life (C) may simultaneously seem adverse to some and favorable to others (D) is often blamed for failures in which it was not a factor (E) though favorable, does not insure the advancement of human welfare.
53. In certain agreements with industrial concerns, labor unions are granted the authority to restrict the number of days a member may work during slack times. Of the following the CHIEF reason that this authority is sought is to (A) force workers to maintain a proper balance between work and leisure (B) reduce lay-offs through a distribution of available work (C) prevent members from being required to work overtime without proper compensation (D) give the inexperienced worker an opportunity to acquire more experience through employment (E) stimulate the demand for workers by limiting the supply of skilled men.
54. EVENTUATE means most nearly (A) intervene (B) prolong (C) expedite (D) initiate (E) result.
55. (Reading) "Exterritoriality is a legal fiction serving to explain the special immunities attaching to the persons and to the habitations of diplomatic agents, who are not subject to the jurisdiction of the country of official residence and thus in a sense are to be regarded as outside the territory." The quotation indicates that exterritoriality (A) provides for exceptions in the application of local laws (B) is a mistaken idea of the courtesy owed to diplomats (C) places special restrictions on the activities of foreign envoys (D) exists in legal theory but not in international practice (E) prevents the expulsion of unpopular diplomatic agents.
56. (Reading) "Manual training emphasizes manual work and habit formation controlled by a disciplinary conception of education, whereas the industrial arts stress mental and social development and the learning content involved. Neither the industrial arts nor manual training has ever functioned effectively as trade education." According to the quotation, manual training (A) furnishes an effective basis for trade education (B) is synonymous with training in the industrial arts (C) emphasizes manual dexterity at the expense of all formal education (D) allows no scope for mental development (E) stresses social values less than do the industrial arts.
57. Of the following, the CHIEF value of the combination of part-time schooling with part-time jobs is that it (A) assures each worker of a full-time job upon graduation from school (B) eliminates the break between full-time schooling and full-time employment (C) permits all young people to secure at least a secondary school education (D) causes students to become highly skilled workers before they enter the employment market (E) proves that unpaid employment benefits only the employer.

58. (Reading) "The production and sale of machinery are directly dependent upon cyclical fluctuations. As the machinery industries supply the technical equipment for all branches of economic activity, their own development and sales react immediately to the slightest change in the economic situation."

According to the quotation, the machinery industry - (A) must meet ever-increasing demands from all kinds of industries (B) is not affected by seasonal fluctuations in the economic field (C) controls the technical development of all other industries (D) is the most sensitive reflector of general business conditions (E) depends for its development on general industrial activity.

59. TRANSCEND means most nearly (A) develop (B) equal (C) strain (D) exceed (E) exhaust

60. Which one of the following is the CHIEF reason why it is impossible to determine in advance the exact financial needs of a law-enforcement agency? (A) Its activities depend upon outside conditions over which it has no control (B) comprehensive and adequate statistics concerning past crimes are difficult to obtain (C) the amount of law violation differs in different jurisdictions (D) present social conditions reflect to a certain extent probable future trends in crime (E) the financial resources of a law-enforcement agency do not necessarily determine its effectiveness.

61. (Reading) "When a high export duty is imposed on a raw material produced mainly in a single country, it may serve not merely to benefit the national exchequer but also to regulate exports with the object of stabilizing the price in the world market on a higher level to the advantage of the producers."

The quotation indicates that high export duties on a given commodity (A) impose on its producers a heavy disadvantage in the world market (B) may affect total imports by limiting exports of the commodity (C) tend to confine its production to a single country (D) increase the government revenue more than they benefit the producers (E) are profitable when a country largely controls the production of the commodity.

62. EXIGENCY means most nearly (A) deficiency (B) emergency (C) expediency (D) experiment (E) permanency.

63. (Reading) "Morale depends upon subordinating the plurality of individual possibilities to the unity of collective purposes, and all that aids in identifying the person with the group is pertinent to the understanding and management of morale."

According to the quotation, (A) it is difficult to merge the individual into the group (B) cooperation is vital to the maintenance of morale (C) the effectiveness of collective action depends upon the ability of the individual leader (D) group effort does not exclude the possibility of individual action (E) an individual's success depends on his singleness of purpose.

64. OBLIVIOUS means most nearly (A) arrogant (B) imperceptible (C) forgetful

65. (Reading) "The state cannot, by virtue of its sovereign power, escape the consequences of its own actions; the results depend upon the nature of those actions and not upon the fact that it is the state that so acts." According to the quotation, the fact that a state possesses supreme authority (A) cannot influence the nature of its actions (B) leads it to ignore its mistakes (C) does not mean that its power can always be enforced (D) lessens the importance of its failures (E) cannot determine the results of what it does.
66. IMPERTURBABILITY means most nearly (A) obstinacy (B) serenity (C) sagacity (D) confusion (E) anxiety.
67. (Reading) "The denomination of a coin does not necessarily indicate the material of which the coin is made, whether its face value is greater than its intrinsic content or whether it is convertible into some other coin or species of money at the option of the holder, or, finally, whether the species of money in question possesses full, partial, or no legal tender." According to the quotation, the denomination of a coin (A) does not reflect its face value (B) indicates whether it possesses legal tender (C) does not indicate its metallic worth (D) signifies its bullion value (E) depends on its intrinsic value.
68. Of the following, the CHIEF argument in favor of a unicameral, or single-chambered, legislative body over one composed of two houses is that in the case of the former (A) there is no check upon their legislative action (B) the minority party wields more power than in a bicameral legislature (C) elections need be held at less frequent intervals (D) the close association of their members fosters unanimity of political opinion (E) more expeditious handling of legislative business is possible.
69. EQUIVOCAL means most nearly (A) ambiguous (B) accidental (C) routine (D) dishonest (E) irrelevant.
70. If no recent hiring has been done by a firm, its minimum wage rate is likely to be relatively high. This is true CHIEFLY because (A) widespread unemployment tends to prevent a high turnover in labor (B) comparatively high minimum wages are now required by Federal law (C) ordinarily, progressive advances in salary accompany increasing experience in a job (D) long-established firms have lessened the gap between maximum and minimum wages (E) high wages attract the most experienced employees in the field.
71. (Reading) "Inequality of bargaining power has long been a ground for legislative and judicial protection of the weaker party. Where the parties are unequal, the State that refuses to redress the inequality is actually denying to the weaker party the equal protection of its laws." According to the quotation, the provision of equal protection under the law (A) cannot be achieved through legislation (B) is denied when special protection is provided (C) is the chief function of the courts (D) makes for inequality of bargaining power (E) corrects natural inequalities between different groups.

72. Of the following, the chief reason why labor unions often oppose cost-of-living plans of wage adjustment is that (A) such plans tend to keep the purchasing power of wages at the same level (B) production costs always fall more rapidly than do living costs (C) money wages are not a reliable indication of real income (D) changes in competitive conditions usually increase the value of labor (E) wages should be regulated according to the employer's ability to pay.
73. POSTULATED means most nearly (A) verified (B) refuted (C) assumed (D) exaggerated (E) imitated.
74. (Reading) "The modern types of by-product recovery afford a powerful stimulus to large-scale production, since the gains are available only when even the least plentiful constituents are present in quantities sufficient to pay for processes of recovery that are often more complex than the main process and involve a large minimum investment of capital."
According to the quotation, by-product recovery (A) is most likely to be profitable in connection with mass production (B) offers the best field for large capital investments (C) is possible to the same degree for all constituents (D) was the initial cause of the development of large-scale production (E) is a comparatively simple but costly process.
75. TOPICAL means most nearly (A) local (B) historical (C) monotonous (D) verbose (E) evident.
76. WONT means most nearly (A) whim (B) need (C) habit (D) ability (E) opinion
77. (Reading) "Manufacturers of quality goods often seek to establish a difference or an impression of a difference between their products and those of their competitors. To the extent to which they succeed they possess a monopoly of those elements in which their product or its reputation is unique, but not of the basic elements of service common to their product and to that of their rivals."
According to the quotation, any product that possesses unique qualities (A) is less serviceable than other products of its type (B) soon overcomes all competition from rival producers (C) is extensively advertised by its manufacturers (D) does not necessarily have a monopoly on service (E) is generally in the relatively expensive class.
78. MACHINATE means most nearly (A) tempt (B) defraud (C) plot (D) mechanize (E) feign.
79. EVANESCENT means most nearly (A) original (B) extinct (C) prevailing (D) unpopular (E) vanishing.

80. (Reading) "The foreign-language press performs simultaneously the opposing functions of promoting assimilation and maintaining separatism. It is the principal medium by which an immigrant group learns to understand its environment. At the same time, the perpetuation of the inherited language and the publication of news of the home country and of the local immigrant group tend strongly to perpetuate a consciousness of difference."

According to the quotation, through the foreign-language press the immigrant (A) learns the superiority of his adopted country to his homeland (B) is both helped and hindered in identifying himself with his new surroundings (C) makes varied contributions to the culture of the country in which he settles (D) develops a confused conception of his duties toward his adopted country (E) has his only connection with his home land.

81. COGENCY means most nearly (A) conciseness (B) hastiness (C) attentiveness (D) conclusiveness (E) impulsiveness.

82. (Reading) "The invention and use of power machinery and the industrialization it entailed, by enabling the fraction of the population that is engaged in agriculture to support large city populations, have vastly raised the standard of living of the community as a whole and have been both the cause and the effect of the development of modern food industries."

According to the quotation, the industrialization resulting from the use of power machinery (A) helped to improve general living conditions (B) had its greatest effect in the food industries (C) brought a rapid increase in urban population (D) enabled all employees to achieve a greater output (E) caused a reduction in the number of agricultural workers.

83. (Reading) "If, from the consideration of a criminal tax case in the light of all recommendations and a hearing, the guilt of the taxpayer is evident and there is a reasonable probability of conviction, the case is regarded as not being a compromisable one and no compromise settlement is made that involves simply the payment of money, regardless of the amount."

The quotation indicates that in certain criminal tax cases (A) hearings are not always held (B) no financial penalties are levied (C) settlement may be made out of court (D) probable guilt is necessary for a compromise settlement (E) convictions are easy to obtain.

By GOODWIN WATSON, PH.D., and EDWARD MAYNARD GLASER, PH.D.

I-A

BATTERY I : DISCRIMINATION IN REASONING — FORM A

TEST 1. GENERALIZATIONS

DIRECTIONS. In this test you will find statements about the behavior or characteristics of certain groups of persons at the present time. Each statement can begin with *All, Most, Few, or No*, thus:

All men have white hair. Most men have white hair.
 Few men have white hair. No men have white hair.

You are to decide, if you can, which form of the statement is most nearly correct.

There will be five possible answers to each statement: *All, Most, "Don't know," Few, or No.*

The statements will appear in the test in the following form:

Sample statements						
	1	2	3	4	5	
(a)	All	Most	DK	Few	No	— men have white hair.
	6	7	8	9	10	
(b)	All	Most	DK	Few	No	— doctors are college graduates.
	11	12	13	14	15	
(c)	All	Most	DK	Few	No	— persons will catch cold next year.
	16	17	18	19	20	
(d)	All	Most	DK	Few	No	— grown persons were formerly children.
	21	22	23	24	25	
(e)	All	Most	DK	Few	No	— college presidents are ten years old.

Sample answers					
	1	2	3	4	5
(a)	⋮	⋮	⋮	█	⋮
	6	7	8	9	10
(b)	⋮	█	⋮	⋮	⋮
	11	12	13	14	15
(c)	⋮	⋮	█	⋮	⋮
	16	17	18	19	20
(d)	█	⋮	⋮	⋮	⋮
	21	22	23	24	25
(e)	⋮	⋮	⋮	⋮	█

All means *every one* without exception. (*All* persons must die sometime.)

Most means *definitely more than half* but not all. (*Most* mothers are fond of their children.)

DK stands for *Don't Know*. It means you don't know whether the number is more or less than half.

Few means *definitely less than half*, but some. (*Few* persons commit suicide.)

No means *not any whatsoever*. (*No* living person is 500 years old.)

Suppose that in Sample (a) you think that, to be true, the statement should be. *Few* men (less than half) have white hair. In Sample (a) *Few* is number 4; so you would make a heavy mark in the space under 4 on the Answer Sheet, as shown in the sample answers.

Suppose that in Sample (b) you think that the statement should be: *Most* doctors are college graduates. In Sample (b) *Most* is number 7; so for Statement (b) you would make a heavy mark in the space under 7 on the Answer Sheet, as shown in the sample answers.

Suppose that in Sample (c) you do not know whether more or less than half the persons in the world will catch cold next year. In such a case you are to choose the answer *DK*. In Sample (c) *DK* is number 13; so you would make a heavy mark in the space under 13 on the Answer Sheet, as shown in the sample answers.

Samples (d) and (e) show how to answer if you believe that "*All* grown persons were formerly children" and "*No* college presidents are ten years old."

That is the way you are to answer the questions in this test. There is no time limit, but keep steadily at work until you finish. Be sure not to skip any statements. **ANSWER EVERY ONE** as best you can.

Do not write your name or make any marks anywhere in this booklet. Your name goes on the Answer Sheet only, as explained by the examiner, and all your marks go on the Answer Sheet.

In marking the Answer Sheet make your mark as long as the pair of lines, and move the pencil up and down firmly to make a heavy black line so it can be easily seen. If you change your mind, erase the first mark thoroughly. Do not leave any stray marks on the Answer Sheet.

Patent No. 1,586,628

Published by World Book Company, Yonkers-on-Hudson, New York, and Chicago, Illinois
 Copyright 1942 by World Book Company. Copyright in Great Britain. *All rights reserved.* PRINTED IN U.S.A. W-G:ICT:I-A-3
 Copyright 1941 by Goodwin Watson and Edward Glaser

Edition a

TEST 1. GENERALIZATIONS (Cont'd)

Begin here.

PART A

- | | | | | | |
|-----|-----|------|----|-----|---|
| 1 | 2 | 3 | 4 | 5 | |
| 1. | All | Most | DK | Few | No — people in Boston like to read detective stories. |
| 6 | 7 | 8 | 9 | 10 | |
| 2. | All | Most | DK | Few | No — uneducated, illiterate people are more superstitious than people who have graduated from universities. |
| 11 | 12 | 13 | 14 | 15 | |
| 3. | All | Most | DK | Few | No — persons in the United States bought new automobiles during 1941 and paid cash in full for them. |
| 16 | 17 | 18 | 19 | 20 | |
| 4. | All | Most | DK | Few | No — dark-haired persons are better-natured than blond-haired persons. |
| 21 | 22 | 23 | 24 | 25 | |
| 5. | All | Most | DK | Few | No — college professors read little in the newspapers except the sports pages and comics. |
| 26 | 27 | 28 | 29 | 30 | |
| 6. | All | Most | DK | Few | No — teachers know better than their pupils what subjects or courses their pupils in elementary school ought to take. |
| 31 | 32 | 33 | 34 | 35 | |
| 7. | All | Most | DK | Few | No — Scotchmen are more careful than are people of any other nationality in spending their money. |
| 36 | 37 | 38 | 39 | 40 | |
| 8. | All | Most | DK | Few | No — criminals would rather be in prison than be free. |
| 41 | 42 | 43 | 44 | 45 | |
| 9. | All | Most | DK | Few | No — Irishmen are more hot-tempered than Italians. |
| 46 | 47 | 48 | 49 | 50 | |
| 10. | All | Most | DK | Few | No — people believe that women drivers of automobiles do not, as a group, drive as skillfully as men. |

PART B

- | | | | | | |
|-----|-----|------|----|-----|--|
| 51 | 52 | 53 | 54 | 55 | |
| 11. | All | Most | DK | Few | No — Communists are interested only in helping their fellow-men rather than in increasing their own personal power or privileges. |
| 56 | 57 | 58 | 59 | 60 | |
| 12. | All | Most | DK | Few | No — Jews would try to cheat a man in a business deal if they thought they had an opportunity to do so. |
| 61 | 62 | 63 | 64 | 65 | |
| 13. | All | Most | DK | Few | No — politicians will take graft from representatives of large corporations who want laws passed giving special privileges or benefits to their companies. |
| 66 | 67 | 68 | 69 | 70 | |
| 14. | All | Most | DK | Few | No — labor-union leaders really try to bring about improvements in the wages, hours, and working conditions of the members of their unions. |
| 71 | 72 | 73 | 74 | 75 | |
| 15. | All | Most | DK | Few | No — physically able persons on relief are willing to take decent jobs that are offered them in private industry. |
| 76 | 77 | 78 | 79 | 80 | |
| 16. | All | Most | DK | Few | No — persons getting government jobs through competitive civil service examinations are not so capable as persons doing similar work in private industry. |
| 81 | 82 | 83 | 84 | 85 | |
| 17. | All | Most | DK | Few | No — Fascists are interested only in helping their fellow-men rather than in increasing their own personal power or privileges. |
| 86 | 87 | 88 | 89 | 90 | |
| 18. | All | Most | DK | Few | No — Protestants would try to cheat a man in a business deal if they thought they had an opportunity to do so. |
| 91 | 92 | 93 | 94 | 95 | |
| 19. | All | Most | DK | Few | No — poor people are poor because they have been too lazy or shiftless to work when jobs were offered to them. |
| 96 | 97 | 98 | 99 | 100 | |
| 20. | All | Most | DK | Few | No — people who are getting the biggest salaries in our largest corporations today worked their way up from humble beginnings without money or influential friends to help them. |

Approved For Release 1999/09/08 : CIA-RDP80-01826R001000010002-2
 TEST 2. INFERENCES

DIRECTIONS. If we know that it is raining, we decide that the ground is wet. The belief that the ground is wet is called an *inference* or a conclusion which we draw from the fact that it is raining.

From a given statement or given set of facts one person may infer one thing and another person may infer something else. Sometimes people draw wrong inferences or conclusions from given statements of facts.

In this test you will find various *statements of facts*. After each statement of fact you will find five possible inferences — that is, inferences which some persons might make from the stated fact. In each of the exercises below you are to accept the statement of fact as true — assume it to be true even if you do not personally believe it to be true. Then examine each inference and make a decision as to its truth or falsity in the light of the given statement.

You are to be concerned not with the truth of the statement of fact but only with the truth of the inference to be drawn from it. It is an error in thinking to jump at conclusions without sufficient evidence; but it is also an error to be over-cautious and fail to recognize a conclusion that may properly be drawn from given facts.

At the left of each inference you will find the letters T, PT, ID, PF, and F. The meaning of these letters is as follows:

T means that you think the inference is definitely a *true* one; that it properly follows from the statement of fact given in the exercise.

PT means that you think the inference is *probably true*; that the facts in the statement point to the probability of the truth of the inference, but that one cannot be entirely sure that it is true on the basis of the facts given in the statement.

ID means that there are *insufficient data*; that you cannot tell from the facts given whether the inference is likely to be true or false.

PF means that, in the light of the facts given in the statement, you think the inference is *probably false*; that the chances are that it is false, but one cannot be entirely sure that it is false.

F means that you think the inference is definitely a *false* one; that it cannot possibly be drawn or inferred from the statement of fact as given in the exercise and in some manner contradicts the stated fact.

Sometimes, in deciding whether a given inference is probably true or probably false, you will have to use certain common knowledge or information which practically every person knows who has ordinary sense. This will be illustrated in the example which follows:

Sample statement and inferences

I. Five thousand first-year high school students recently attended a week-end conference at which questions of race relations and of possible attitudes toward war were discussed, these being the problems the students felt to be the most vital today.

- | | | | | | |
|--|----|----|----|----|----|
| (a) As a group, the students who attended this conference had a greater interest in humanitarian or broad social problems than most first-year high school students have. | 1 | 2 | 3 | 4 | 5 |
| | T | PT | ID | PF | F |
| (b) The students were all between the ages of 10 and 11. | 6 | 7 | 8 | 9 | 10 |
| | T | PT | ID | PF | F |
| (c) The students came from all sections of the country. | 11 | 12 | 13 | 14 | 15 |
| | T | PT | ID | PF | F |
| (d) The students came to discuss trade-union problems. | 16 | 17 | 18 | 19 | 20 |
| | T | PT | ID | PF | F |
| (e) The question of attitudes toward war is considered by many high school students to be important enough to be discussed. | 21 | 22 | 23 | 24 | 25 |
| | T | PT | ID | PF | F |

Sample answers

	1	2	3	4	5
(a)	⋮	■	⋮	⋮	⋮
	6	7	8	9	10
(b)	⋮	⋮	⋮	■	⋮
	11	12	13	14	15
(c)	⋮	⋮	■	⋮	⋮
	16	17	18	19	20
(d)	⋮	⋮	⋮	⋮	■
	21	22	23	24	25
(e)	■	⋮	⋮	⋮	⋮

In the above sample, inference (a) is *probably true* (PT) because (as is common knowledge) most first-year high school students are not likely to be so seriously concerned with such broad social problems.

Inference (b) is *probably false* (PF) because children between 10 and 11 years of age are not usually so interested in social problems that 5000 of them would attend such a conference; furthermore, there are extremely few high school students between 10 and 11 years of age.

There is just no evidence for inference (c); there are *insufficient data* (ID) for making a judgment in the matter.

Inference (d) is definitely *false* (F) because it contradicts the given statement of fact.

Inference (e) is the only one among those offered which necessarily follows from the given facts; it is therefore *true* (T).

In the exercises which follow, more than one of the inferences from a given statement may be true, or false; or probably true, or probably false, or have insufficient data to warrant a judgment. That is, you are to consider each inference by itself and disregard your answers to other inferences.

TEST 2. INFERENCES (Cont'd)

PART A

I. Yesterday, a freight elevator in the Main Building fell four stories and struck the bumpers at the bottom of the shaft. The elevator, operated by Michael Jackson, had stopped at the fourth floor to let off part of the cleaning crew. Just as Jackson was about to open the door, the elevator began to drop. Jackson immediately applied the emergency brake, but it did not hold, whereupon he shouted, "We're going to crash!"

- | | | | | | |
|---|----|----|----|----|----|
| 1. The original cause of the accident was a deficient emergency brake.... | 1 | 2 | 3 | 4 | 5 |
| | T | PT | ID | PF | F |
| 2. The emergency brake was deficient..... | 6 | 7 | 8 | 9 | 10 |
| | T | PT | ID | PF | F |
| 3. The elevator operator tried to stop the elevator from falling..... | 11 | 12 | 13 | 14 | 15 |
| | T | PT | ID | PF | F |
| 4. Some of the cleaning crew were very much frightened by the drop..... | 16 | 17 | 18 | 19 | 20 |
| | T | PT | ID | PF | F |
| 5. The cleaning crew of the Main Building never uses the passenger elevators in that building. | 21 | 22 | 23 | 24 | 25 |
| | T | PT | ID | PF | F |

II. Mr. Brown, who lives in the town of Salem, was brought to court for the fourth time in the past month on a charge of keeping his dance hall open after midnight. He pleaded guilty and was again given the maximum fine of \$100 by the authorities of Salem.

- | | | | | | |
|---|----|----|----|----|----|
| 6. The neighbors complained that Mr. Brown's customers made a lot of noise; that is why the midnight closing law was enacted..... | 26 | 27 | 28 | 29 | 30 |
| | T | PT | ID | PF | F |
| 7. The maximum fine of \$100 is effective in keeping all dance halls closed in Salem after midnight..... | 31 | 32 | 33 | 34 | 35 |
| | T | PT | ID | PF | F |
| 8. Mr. Brown's dance hall is located within the legal jurisdiction of the town of Salem..... | 36 | 37 | 38 | 39 | 40 |
| | T | PT | ID | PF | F |
| 9. Less than half a dozen people want Mr. Brown's dance hall open after midnight..... | 41 | 42 | 43 | 44 | 45 |
| | T | PT | ID | PF | F |
| 10. Mr. Brown thought either that he could "get away with it," or that he could get the law changed or that it would pay him to keep his place open after twelve o'clock, even though he had to risk paying frequent fines..... | 46 | 47 | 48 | 49 | 50 |
| | T | PT | ID | PF | F |



III. Every year during spells of intense heat an unusually large number of people crowd to the beaches and go swimming. Newspapers report more people drowned while bathing during heat spells than at any other time.

- | | | | | | |
|--|----|----|----|----|----|
| 11. Intense heat causes cramps in many swimmers..... | 51 | 52 | 53 | 54 | 55 |
| | T | PT | ID | PF | F |
| 12. The newspapers print such reports for the purpose of persuading people not to go swimming..... | 56 | 57 | 58 | 59 | 60 |
| | T | PT | ID | PF | F |
| 13. The most important reason why more people are drowned during heat spells is that more people go swimming then..... | 61 | 62 | 63 | 64 | 65 |
| | T | PT | ID | PF | F |
| 14. The actual number of deaths from drowning is the same during heat spells as at any other time, but the newspapers just make a point of featuring them at such times..... | 66 | 67 | 68 | 69 | 70 |
| | T | PT | ID | PF | F |
| 15. Since there are more lifeguards at the beaches during the very hot weather, there is no danger of drowning..... | 71 | 72 | 73 | 74 | 75 |
| | T | PT | ID | PF | F |

TEST 2. INFERENCES (Cont'd)

IV. The town of Westfield, beginning twenty years ago, has gradually bought up farms abandoned by owners who failed to pay taxes, and set out some 5600 acres of community forest. The pine trees set out twenty years ago are now more than twenty feet tall. The town forests yielded \$6000 profit last year on cordwood, and local authorities believe that the lumber revenue will eventually be \$20,000 a year, thus eliminating the need for town taxes.

- 16. The town of Westfield has found one way of using abandoned farm land. T PT ID PF F
- 17. The soil of the community forest in Westfield is favorable for the growth of pine trees. T PT ID PF F
- 18. The Westfield town forests will yield an annual profit of \$20,000 within two or three years. T PT ID PF F
- 19. The owners who failed to pay their taxes and abandoned their farms were either incompetent farmers or lazy ones. T PT ID PF F
- 20. It costs the town more to cut and sell the cordwood and lumber than the sales bring in. T PT ID PF F

V. An English teacher in a small-town high school was interested in finding out whether her students would gain more knowledge and appreciation of Charles Dickens's story *Great Expectations*, through (1) seeing a motion-picture production of the story, or through (2) reading the book and studying and discussing it in class without seeing the picture. Accordingly, she arranged for the students in one of her classes to see the movie *Great Expectations*, adapted from Dickens's book of that title, while the students in one of her other classes studied the book itself, in the usual manner, without the aid of the picture. On all the tests to measure appreciation and understanding of the story, the class which was taught with the aid of the movie did better. The class which saw the movie enjoyed it so much and became so interested that before the semester was over most of the students read the book entirely on their own initiative. They were curious to see how well the movie producers had portrayed Dickens's characters.

- 21. The teacher who conducted the experiment will hereafter try to use motion pictures when they are available, as an aid in teaching literary appreciation. T PT ID PF F
- 22. The children who were taught with the aid of the motion picture were required to read the book *Great Expectations* immediately after seeing the picture. T PT ID PF F
- 23. Pupils can learn more about a given subject from motion pictures than they can from books. T PT ID PF F
- 24. Most of the children in the class which saw the picture would have preferred to study the book *Great Expectations* in the usual way without the aid of the movie. T PT ID PF F
- 25. The students who saw the movie gave evidence that they understood the story at least as well as did those who only read the book. T PT ID PF F

TEST 2. INFERENCES (Cont'd)

PART B

VI. The first newspaper established in America appeared in Boston late in the seventeenth century. During a period of unrest when many people were dissatisfied with the government of Boston, the publisher ran into difficulties with the Boston authorities, who tried to suppress the paper. His long fight to continue his little paper and to print the truth as he saw it marks an important episode in the continuing struggle to maintain a free press.

- 26. The publisher of the first American newspaper resisted attempts to interfere with his freedom of expression. T PT ID PF F
- 27. The publisher of this paper wrote articles against taxes of the kind that later brought about the "Boston Tea Party." T PT ID PF F
- 28. The first American newspaper was published by the Boston government authorities. T PT ID PF F
- 29. The editor of the first American newspaper, as soon as he discovered the disapproval of the Boston authorities, changed the policy of his paper to conform to their wishes, and after that the authorities did not bother him. T PT ID PF F
- 30. Before this newspaper criticized the authorities there had been no criticisms of any kind whatsoever of the authorities of Boston. T PT ID PF F

VII. In the midst of a disastrous coal strike, the company police fired their revolvers directly into a crowd of striking miners. Two days later one of the United States Senators from the state and several labor leaders spoke at a mass meeting called by the union and held in the capital city of the state. The meeting was attended by 10,000 people. Some miners wearing bandages were on the platform. Although reporters from the city where the strike occurred were present, not a word about the meeting or the speeches, most of which strongly condemned the mine owners, was printed in any newspaper in that city. Nearly every other newspaper in the state, as well as some out-of-state newspapers, did report the mass meeting.

- 31. None of the striking miners was injured by the company police. T PT ID PF F
- 32. The newspapers in that city were controlled or strongly influenced by the mine owners. T PT ID PF F
- 33. The United States Senator who spoke at the meeting supported the union side in this affair. T PT ID PF F
- 34. The miners had aroused antagonism by destroying the property of other people. T PT ID PF F
- 35. In this instance the union did not get fair treatment for its side of the controversy in the newspapers of the city where the strike occurred. T PT ID PF F



VIII. June 25, 1939 (*N. Y. Times*). Japan bought aircraft material costing more than \$1,000,000 in this country during the first five months of 1939, the Department of Commerce reported today. The United States has protested strongly against Japanese bombing in China. Total United States exports of aeronautic equipment . . . totaled \$38,247,052 in the period, an increase of 31 per cent over the first five months of 1938. Japan also imported airplanes from Europe.

- 36. In spite of its protest, the United States government either could not or did not wish at that time to stop American aircraft concerns from exporting aircraft material to Japan. T PT ID PF F
- 37. The American aircraft material exported to Japan was primarily of a commercial rather than of a military type. T PT ID PF F
- 38. Most of the United States exports of aeronautic material for the first five months in 1939 were to Japan. T PT ID PF F
- 39. If the manufacturers knew that the aircraft materials they sold to Japan might be used in the bombing of China, they would not have sold these materials to Japan. T PT ID PF F
- 40. If the United States had prohibited export of aeronautic equipment to Japan, Japan would have discontinued her war on China. T PT ID PF F

IX. On November 15, 1941, Saburu Kurusu arrived in Washington as a special Japanese envoy, sent by his government presumably to try to agree on a peaceful settlement with the United States of differences between the two countries. After several conversations among the President of the United States and Japan's envoys — Kurusu and Ambassador Nomura — our Secretary of State — Cordell Hull — on November 26 gave the Japanese a memorandum containing the basis for a general peaceful settlement of the problems between the two countries. On December 7, the two Japanese envoys called at the State Department in Washington to present a document containing their reply to the memorandum which Secretary Hull gave them Novem-

ber 26. At the precise moment that Secretary Hull received the Japanese envoys, word was being received at the White House that Japan's air force and submarines had suddenly and without warning attacked Hawaii, killing many Americans and causing serious damage to United States warships and airplanes stationed there. The Japanese planes took off against Hawaii from airplane carriers which had managed to come within striking distance unobserved in the vast expanses of the Pacific Ocean. The nearest bases from which Japanese naval and air forces could have operated were in certain islands in the Pacific which are more than 2200 miles from Hawaii.

- | | | | | | |
|---|----|----|----|----|----|
| 41. The Japanese had little knowledge of the condition of the American defenses in Hawaii. | 26 | 27 | 28 | 29 | 30 |
| | T | PT | ID | PF | F |
| 42. If the American forces in Hawaii had known at least a few hours in advance that the Japanese were on the way to attack them, they could have offered more effective resistance than they did. | 31 | 32 | 33 | 34 | 35 |
| | T | PT | ID | PF | F |
| 43. If President Roosevelt had talked personally with Japan's envoys instead of sending them to see Secretary of State Hull, Japan would not have attacked the United States forces at Hawaii. | 36 | 37 | 38 | 39 | 40 |
| | T | PT | ID | PF | F |
| 44. Japanese envoy Saburu Kurusu knew before he saw Cordell Hull on December 7 that Japanese forces had already attacked Pearl Harbor. | 41 | 42 | 43 | 44 | 45 |
| | T | PT | ID | PF | F |
| 45. The Japanese attackers must have been approaching Hawaii for several days and must have been planning this attack for some time; even while their envoy was supposedly trying to reach a peaceful settlement in Washington. ... | 46 | 47 | 48 | 49 | 50 |
| | T | PT | ID | PF | F |

X. On August 23, 1939, in the midst of negotiating a possible military alliance with England and France, Soviet Russia unexpectedly announced a non-aggression pact with Nazi Germany. The pact provided that Germany and Russia would "refrain from every act of force, every aggressive action, and every attack against one another"; that "if either should become the object of warlike acts by a third power, the other party will in no

way support this third power." On September 1, Germany invaded Poland. On September 3, England and France, bound by treaty to aid Poland, declared war on Germany. By September 15, the Germans had seized all of Poland's industrial centers. Russia, although not declaring war, on September 17 sent troops to occupy more than one third of Poland. On September 22, Germany and Russia divided Poland between themselves.

- | | | | | | |
|--|----|----|----|----|----|
| 46. If negotiations between Russia and England and France had been successful, and Russia had not concluded this non-aggression pact with Germany, the probability of Germany's invasion of Poland would have been lessened. ... | 51 | 52 | 53 | 54 | 55 |
| | T | PT | ID | PF | F |
| 47. In accordance with the terms of the Russian-German non-aggression pact as given in the statement of this problem, Russia was obligated to invade Poland and to fight on the side of Germany. | 56 | 57 | 58 | 59 | 60 |
| | T | PT | ID | PF | F |
| 48. Whoever wins the war, Poland will rise again, as she has risen in the past. | 61 | 62 | 63 | 64 | 65 |
| | T | PT | ID | PF | F |
| 49. The portion of Poland which Russia took was obtained more easily as a result of her "friendship" pact with Germany than it could have been obtained if Russia had gone to war with Germany and fought for that territory. | 66 | 67 | 68 | 69 | 70 |
| | T | PT | ID | PF | F |
| 50. Russia took advantage of the situation in which Germany was at war with the Allies to occupy a large portion of Poland which otherwise might have been taken by Germany. | 71 | 72 | 73 | 74 | 75 |
| | T | PT | ID | PF | F |

TEST 3. DISCRIMINATION OF ARGUMENTS

DIRECTIONS. In deciding important questions it is necessary to distinguish between arguments that are strong and important and those that are weak and unimportant.

This test consists of a series of questions. Under each question are four statements or arguments which might be put forth in support of either side of the question. Some of these arguments, if regarded as true,

would be strong and important arguments in support of or in opposition to the question at issue. Others, even though regarded as true, would nevertheless be weak and relatively unimportant. Read each argument carefully, and for the purposes of this test regard the argument as true; then decide whether you would call it strong or weak.

You are to indicate your decision as shown below.

Sample question and arguments			Sample answers	
I. Is it desirable for all young men to go to college?			1	2
(a) Yes; if they go to college they will learn the school yells.....	Strong	Weak	(a) <input type="checkbox"/>	<input type="checkbox"/>
(b) No; some college men are conceited.	Strong	Weak	(b) <input type="checkbox"/>	<input type="checkbox"/>
(c) Yes; college is likely to increase their earning powers and culturally enrich their lives.....	Strong	Weak	(c) <input type="checkbox"/>	<input type="checkbox"/>
(d) No; many young men cannot profit from college work and might better spend those years in more definite vocational training.....	Strong	Weak	(d) <input type="checkbox"/>	<input type="checkbox"/>

Argument (a) is a rather unimportant and silly reason for spending four years at college; hence it is marked *Weak*.

Argument (b) does not state that all college men are conceited, or that some non-college men, are not also conceited or that everyone who goes to college will become conceited. The reason as stated is practically meaningless as an argument against going to college; hence it also is marked *Weak*.

Argument (c), if taken to be true, is a *strong* argument for the statement; hence it is marked *Strong*.

Argument (d), if taken to be true, is a strong argument against the statement; hence it is marked *Strong*.

Judge each of the arguments with care. Assume that each argument is true. Decide whether you think the

argument is a strong, important argument with reference to deciding the question at issue, and if you think it is, you are to mark it *Strong*; if, however, you think the argument is weak and unimportant or unrelated to the question at issue, you are to mark it *Weak*.

Try to arrive at a judgment for every argument, but if you feel that you cannot determine whether a given argument is *Strong* or *Weak*, then do not guess, for in this test there is an extra score penalty for answers that are marked incorrectly.

Judge each argument separately. In connection with some of the questions you may decide that all the arguments given are *Strong* or that all the arguments are *Weak*. Be sure to judge each argument on its own merit without regard for how you have judged any of the other arguments with reference to the given question.

PART A

I. Should some refugees from religious and political persecution in other countries be granted admission to the United States?

- | | | |
|--|--------|------|
| 1. No; we have not provided jobs for millions of our own citizens at present, and until we solve that problem these refugees would add seriously to the burden of unemployed..... | 1 | 2 |
| | Strong | Weak |
| 2. Yes; if the United States took some of the refugees, it would help the cause of democracy, freedom, and tolerance at a time when these achievements of civilization are being sorely attacked in many parts of the world..... | 3 | 4 |
| | Strong | Weak |
| 3. Yes; the United States has been a country to which the oppressed from all lands could come for refuge and a new life..... | 5 | 6 |
| | Strong | Weak |
| 4. No; many of the refugees did not obey all the laws in the countries from which they escaped..... | 7 | 8 |
| | Strong | Weak |

Remember: For purpose of this test regard each argument as true; then decide whether you would call it *Strong* or *Weak*.

TEST 3. DISCRIMINATION OF ARGUMENTS (Cont'd)

II. In time of war or other national emergency, should full freedom of press, speech, and assembly be granted in a democracy to minority groups who do not believe in and are actively opposed to democracy?

- | | | |
|---|--------------|------------|
| 5. Yes; for variety of ideas makes life more interesting. | 9
Strong | 10
Weak |
| 6. No; for the unpopularity of the ideas of the groups who do not believe in democracy might start some disagreements and fights. | 11
Strong | 12
Weak |
| 7. No; for if the opponents of democracy were given freedom they would mislead and disunite the people, which in turn would lead to a loss of democracy and all democratic freedoms. | 13
Strong | 14
Weak |
| 8. Yes; for democracy will learn from its critics what must be done to deserve and to preserve the confidence of the people. | 15
Strong | 16
Weak |

III. Should the Federal government pay farmers for soil-conservation practices that cost time and money?

- | | | |
|---|--------------|------------|
| 9. Yes; the welfare of every group in the nation depends eventually upon the soil, which would be rapidly worn out if conservation practices were not made possible through Federal aid to the farmers. | 17
Strong | 18
Weak |
| 10. No; by soil-conservation practices the farmer adds to the fertility and value of his own land; to pay farmers out of public funds for helping themselves would be unfair to everyone else and opposed to the public welfare. | 19
Strong | 20
Weak |
| 11. Yes; some farmers have come to depend on such payments and would be required to reduce their standard of living if the payments stopped. | 21
Strong | 22
Weak |
| 12. No; it would require a considerable expenditure of public funds to pay farmers for soil-conservation practices. | 23
Strong | 24
Weak |

IV. Are labor unions helpful to the welfare of the majority of the people in the United States?

- | | | |
|---|--------------|------------|
| 13. No; labor unions sometimes require men to go out on strike and these strikes often hurt the business of the employer. | 25
Strong | 26
Weak |
| 14. Yes; labor unions are the only form of organization which will adequately protect the interests and rights of the workers. | 27
Strong | 28
Weak |
| 15. No; organized labor constitutes a monopoly which often serves its own selfish interests in opposition to the public welfare by creating scarcity of workers, opposing efficiency and work-saving machinery, and requiring unnecessary men to be hired on jobs, thus raising costs. | 29
Strong | 30
Weak |
| 16. Yes; organized labor groups were among the first advocates of public schools in the United States, and opportunity for free education is a desirable thing. | 31
Strong | 32
Weak |

V. In a time of widespread unemployment should relief funds be provided by the Federal government?

- | | | |
|--|--------------|------------|
| 17. No; for individuals and localities will then lean on the Federal government rather than exercise their own efforts, initiative, and ingenuity. | 33
Strong | 34
Weak |
| 18. Yes; for the Federal government owns billions of dollars' worth of gold now buried in the hills of Kentucky. | 35
Strong | 36
Weak |
| 19. Yes; for the problem is national in scope and cannot otherwise be solved by individuals or by those localities where, due to poverty, the burden is heaviest. | 37
Strong | 38
Weak |
| 20. No; for in some regions the local officials are corrupt and use the money from Washington not to help those most in need but to reward their political supporters. ... | 39
Strong | 40
Weak |

Remember: For purpose of this test regard each argument as true; then decide whether you would call it Strong or Weak.

TEST 3. DISCRIMINATION OF ARGUMENTS (Cont'd)

PART B

VI. Can rich and poor obtain, on the whole, equal justice from the courts in the United States today?

- | | | |
|--|--------|------|
| 21. No; for all governmental agencies in a capitalistic society are fundamentally designed to protect the privileges of the owning class..... | 41 | 42 |
| | Strong | Weak |
| 22. No; there are many dramatic cases illustrating prejudice against the poor.... | 43 | 44 |
| | Strong | Weak |
| 23. Yes; judges take an oath to support the law and the Constitution without fear or special favors. | 45 | 46 |
| | Strong | Weak |
| 24. Yes; when a poor man sues a rich man or a large corporation, the jury's sympathies are more likely to be with the poor man, thus balancing any other advantage which the rich man may have. | 47 | 48 |
| | Strong | Weak |

VII. Should the government take over all the main industries, employ all who want to work, and reduce prices of the products made?

- | | | |
|--|--------|------|
| 25. Yes; the government is already running the army, navy, marines, post offices, veterans' insurance, public health, public housing, public works, and national parks... | 49 | 50 |
| | Strong | Weak |
| 26. No; few men will work as hard and as intelligently for the public in general as they will for their own business; government enterprise will therefore lack the efficiency to produce as high a standard of living as we have had with private business. . . | 51 | 52 |
| | Strong | Weak |
| 27. No; there have been numerous instances in which public officials have been found guilty of graft and corruption. | 53 | 54 |
| | Strong | Weak |
| 28. Yes; when all who want to work are employed by the government, prices will be reduced and people will have the purchasing power to buy the increased output. Only in this way can poverty be abolished. | 55 | 56 |
| | Strong | Weak |

VIII. Should the government of the United States put into effect a "health security" system that would bring free medical care to those families having annual incomes of less than \$3000?

- | | | |
|---|--------|------|
| 29. No; socialized medicine or "health security" means that the doctors work for the government on a straight salary basis. The personal interest of doctor in patient would be seriously lessened; thus the patients would not receive competent treatment | 57 | 58 |
| | Strong | Weak |
| 30. Yes; many doctors who do not at present earn a comfortable living because they do not have enough paying patients could find steady jobs in this new government health service. | 59 | 60 |
| | Strong | Weak |
| 31. No; many people may hardly ever need a doctor; under a "health security" system they would be paying money and not receiving any services in return..... | 61 | 62 |
| | Strong | Weak |
| 32. Yes; "health security" would make available complete and competent medical and dental treatment for those millions of citizens who earn so little money that they cannot save and cannot now afford proper care. | 63 | 64 |
| | Strong | Weak |

IX. Should the public be taxed to provide college education free for all intellectually superior young persons who want it but cannot afford to pay their own way?

- | | | |
|--|--------|------|
| 33. No; facing difficulties builds character; why not let the poor try to work their way through college?..... | 65 | 66 |
| | Strong | Weak |
| 34. Yes; the public spends a great deal of money on free education for the dull, delinquent, and handicapped; why not make possible a higher education for gifted young persons?..... | 67 | 68 |
| | Strong | Weak |
| 35. Yes; without free tax-supported education available to such persons society will lose the contributions of many of our ablest minds in fields where special college training is necessary, such as scientific research. | 69 | 70 |
| | Strong | Weak |
| 36. No; intellectually superior young persons can get the equal of a formal college education through study on their own initiative plus a few evening courses in more technical subjects. The expense involved in such a plan therefore is not justified... | 71 | 72 |
| | Strong | Weak |

TEST 3. DISCRIMINATION OF ARGUMENTS (Cont'd)

X. Should the income of every family head be increased by a government subsidy for each dependent child, so that the cost of proper care for the child is provided without lowering the standard of living for the rest of the family?

- | | | | | |
|--|----|----|--------|------|
| 37. No; additional revenue would have to be found in order to make possible such government support and taxes are already high. | 73 | 74 | Strong | Weak |
| 38. No; such an arrangement would reduce enterprise and the desire to work, and would lead to the birth of children unwanted except for the subsidy they bring in. . . . | 75 | 76 | Strong | Weak |
| 39. Yes; such an arrangement would reduce the worries of many parents. | 77 | 78 | Strong | Weak |
| 40. Yes; with state financial support for the care of offspring, no child would have to suffer from undernourishment, bad housing, inadequate education, or other evil consequences of poverty; the public as a whole would, in the long run, benefit. | 79 | 80 | Strong | Weak |



THE UNITED STATES ARMED FORCES INSTITUTE TESTS OF GENERAL EDUCATIONAL DEVELOPMENT

TEST
1
COLLEGE
FORM B

COLLEGE LEVEL

TEST ONE: CORRECTNESS AND EFFECTIVENESS OF EXPRESSION

DIRECTIONS

Your answers to the exercises in this test are to be recorded on the separate ANSWER SHEET which is provided. **Take this answer sheet now;** write your name and the other information called for in the blanks at the top of the page; then finish reading these directions.

This test is intended to measure your ability to write correctly and effectively. The test contains two parts. Part I is a spelling test of 25 exercises. Each exercise consists of four words, one of which may be misspelled. On the answer sheet (Part I), you will find 25 rows of boxes numbered to correspond to these 25 exercises. Each row contains five boxes. To mark an exercise, decide first which word, if any, is incorrectly spelled. Then find the corresponding row of boxes on the answer sheet, and mark a ~~circle~~ ^{LINE} in one of these boxes as follows: If the first word is misspelled, mark the first box in the row; if the second word is misspelled, mark the second box; if the third word is wrong, mark the third box; if the fourth word, mark the fourth box; and if **none of the words is wrong**, mark the last box in the row. Quite a few of the exercises actually contain no misspelled words; that is, the fifth response is often the correct response.

Part II of the test consists of four "themes" such as might have been written by a college freshman, and which contain many of the errors frequently found in such themes. You are to indicate, in a manner which is explained in the special directions for Part II, what corrections or changes should be made in the themes to improve their quality.

Answer the exercises in the order in which they are given, but do not spend too much time on difficult exercises. Make the best choice you can, and go on to the next exercise.

Make certain each time that your mark is placed in the right box in the right row. If you change your mind, erase your first mark thoroughly.

One reason for using a separate answer sheet is to make it possible to use this test booklet over again. Accordingly, you should be very careful to MAKE NO MARKS ON ANY PAGE OF THIS BOOKLET! Do not fold or tear the pages; keep the booklet in as good condition as you can.

Re-read these directions carefully; then turn the page and begin work.

TOTAL TESTING TIME: 2 HOURS

Prepared by the
EXAMINATIONS STAFF FOR THE UNITED STATES ARMED FORCES INSTITUTE

Published and Distributed by

**COOPERATIVE TEST DIVISION
EDUCATIONAL TESTING SERVICE**

Los Angeles, California

Princeton, N. J.

Chicago, Illinois

PART I

Directions: In the row of boxes corresponding to each exercise, mark the box corresponding to the misspelled word. If none of the words is misspelled, mark the last or fifth box in the row. Note how the first two (sample) exercises are marked on the answer sheet.

- | | | | |
|--|---|---|---|
| S-1. 1. equal
2. ready
3. qualaty
4. improve
5. none misspelled | 6. 1. irritable
2. crusade
3. resurrection
4. coordinate
5. none misspelled | 13. 1. mountainous
2. interogate
3. futility
4. perspiration
5. none misspelled | 20. 1. exagerate
2. delineate
3. loathsome
4. malignant
5. none misspelled |
| S-2. 1. correct
2. practice
3. perfect
4. justice
5. none misspelled | 7. 1. reherse
2. burglary
3. dominant
4. adjourn
5. none misspelled | 14. 1. adviseable
2. perimeter
3. disfranchise
4. jubilant
5. none misspelled | 21. 1. nucleus
2. picturesque
3. controversy
4. heredity
5. none misspelled |
| 1. 1. stringent
2. colloquial
3. fallacy
4. medeval
5. none misspelled | 8. 1. whimsical
2. daily
3. foundation
4. infinite
5. none misspelled | 15. 1. bravado
2. flourish
3. loyalty
4. quandery
5. none misspelled | 22. 1. latitude
2. coherant
3. chameleon
4. sardonic
5. none misspelled |
| 2. 1. magistrate
2. alliteration
3. notoriety
4. scholastic
5. none misspelled | 9. 1. acknowledge
2. grammar
3. homily
4. embarrassment
5. none misspelled | 16. 1. physician
2. adolescent
3. privelege
4. irrelevant
5. none misspelled | 23. 1. eminance
2. courtesy
3. geranium
4. punctuate
5. none misspelled |
| 3. 1. quinine
2. leutenant
3. jocular
4. pleasurable
5. none misspelled | 10. 1. sacrilegious
2. pesimism
3. exemplary
4. litigant
5. none misspelled | 17. 1. enigma
2. debateable
3. orthodox
4. malicious
5. none misspelled | 24. 1. recipient
2. dubious
3. anuity
4. kinetic
5. none misspelled |
| 4. 1. plurality
2. ignorance
3. Parlament
4. strident
5. none misspelled | 11. 1. solemnity
2. conspicuous
3. estrangement
4. miscelany
5. none misspelled | 18. 1. inseperable
2. digress
3. penury
4. belligerent
5. none misspelled | 25. 1. penalty
2. acquiesce
3. diagonal
4. insoluable
5. none misspelled |
| 5. 1. youngster
2. longitude
3. behavior
4. fatigue
5. none misspelled | 12. 1. commissioner
2. handkerchief
3. necessary
4. phantom
5. none misspelled | 19. 1. luxuriant
2. prodigious
3. dissernment
4. bichloride
5. none misspelled | |

Go right on to Part II

PART II

Directions: The first of the "themes" is reproduced below in its original defective form. Read this version once through carefully to get a clear notion of what the theme is about, but without yet trying to decide upon any corrections. Then read the directions immediately following the theme. Don't spend too much time on this first reading.

Theme I

Last summer I undertook to edit a volume of reports authored by committees of teachers. If there is anything worse than a report written by a teacher, they are reports written by a committee of teachers. They have the knack of saying what better could be said in four, in forty words.

One day I told my troubles to the editor of a scientific journal. "I know what you are up against," he said, "you may expect that scientific writing utilizes a minimum of verbiage—and so it does, at its best—but the average manuscript we receive can be cut by a third or half without suffering anything but improvement.

"The abstracts we publish are especially trying. They are limited to 225 words, but most contributors can not say what they have to say in less than 800 words. In most of them, especially the younger men, it is a simple matter to cut the manuscript to the required length. But one day I received an abstract from an elderly

scientist who wrote with New England economy. It turned out to have 226 words. I thought I had made a mistake, so I counted again, but no, Professor Chadwick had made the mistake; there were at least 226 words. Of course, the extra word was of no consequence, and I would have let it go, except it was a challenge to me. I wondered whether I could find one word which could be taken out without spoiling it, so that I could kid Professor Chadwick about it.

"Well, do you know, I spent pretty near two days on that manuscript without finding a single word that could be left out without injury when I came across an "and" in the first paragraph that could be substituted by a semicolon without injuring neither sense nor style.

"I struck it out and was just planning what I would say to Professor Chadwick when this telegram arrived: 'Horrified to find my abstract has 226 words. Kindly strike out "and" in first paragraph.'

Directions (continued)

The theme printed above has been re-printed in a narrow column on the left-hand side of the following pages, with certain portions or situations underlined and numbered. On the right-hand side of each page, several ways are suggested of writing each underlined situation. Before reading the rest of these directions, glance briefly at the numbered situations and answers on the opposite page; then finish reading these directions.

The situations are numbered consecutively all the way through the four themes. On the answer sheet (Part II), you will find as many rows of boxes as there are numbered situations in the themes. The number of each row corresponds to the number of an underlined situation; the boxes correspond to the suggested "answers" for that situation: the first box in the row corresponds to the first answer, the second box to the second answer, etc.

For each numbered situation you are to decide which answer is **best**, and to mark an X in the corresponding box on the answer sheet. The first (sample) situation (S-1) has been marked correctly on the answer sheet; you are to mark the others in a similar fashion. You will note that sometimes the best answer is the one already used in the theme. Sometimes the theme would be improved if the underlined portion were left out entirely, without substituting anything for it; in that case you are to mark the box corresponding to the response "OMIT."

The suggestions you check should be consistent with one another and with the meaning, organization, and style of the theme as a whole. Sometimes, your choice of the best answer for a situation will depend upon what you intend to do about the situations immediately following it. Hence, it will be well for you, before marking each situation, to look ahead at two or three situations following it, in order to see how they affect the situation you are marking.

Correct, formal English is required; do not attempt to employ colloquial English or an unusual style. Note that in many exercises two or more of the responses are grammatically correct, but one is definitely more **effective** than the others. Always consider **all** responses before deciding.

Make sure each time that your mark is placed in the row numbered the same as the situation. If you decide to skip a situation, be sure to skip the corresponding row on the answer sheet also. If you change your mind, erase your first mark very thoroughly.

Work at whatever speed seems natural to you, but waste no time. Go ahead!

Last summer I undertook to edit
S-1

a volume of reports
authored by committees of
1

teachers. If there is anything
worse than a report written by a
teacher, they are reports

2
written by a committee of
teachers. They have the knack
of saying what better could

3
be said in four,
in forty words. One day I

4
old my troubles to the editor
of a scientific journal. "I
know what you are up against,"
he said, "you may

5
expect that scientific writing
6

utilizes a minimum of verbiage—
7

and so it does, at its best—but
the average manuscript we receive
can be cut by a third or half

8
without suffering anything but
improvement.

"The abstracts we
publish are especially trying.
They are limited to 225 words,
but most contributors
can not say what they have
to say in less than

9
800 words.
In most of them, especially the
10

S-1. 1. undertook to edit
2. had to edit
3. had the job of editing
4. had the awful job of editing

1. 1. authored
2. authorized
3. written
4. composed

2. 1. they are reports
2. it is when
3. it is reports
4. it is a report

3. 1. (Leave where it is now.)
2. (Place after "of saying.")
3. (Place after "be said.")
4. (Place after "in four.")

4. 1. (Leave where it is now.)
2. (Place after "knack.")
3. (Place after "of saying.")
4. (Place after "be said.")

5. 1. said, "you
2. said: "you
3. said; "you
4. said. "You

6. 1. expect 2. suspect 3. suppose 4. surmise

7. 1. utilizes a minimum of verbiage
2. makes every word count
3. errs on the side of brevity
4. avoids redundant verbosity

8. 1. or half
2. or in half
3. or a half
4. or one-half

9. 1. can not say what they have to say in less than
2. can not give their message to the world in less
than
3. can not find a place to stop short of
4. submit at least

10. 1. In most of them
2. To most of them
3. For most of them
4. Most of them

younger man, it is a simple matter to cut the manuscript to the required length. But one day I received an abstract from an elderly scientist who wrote with New England economy.

It turned out to have 226 words.

11

I thought I had made a mistake, so I counted again, but no, Professor Chadwick had made the mistake; there were at least

12

226 words. Of course, the extra word was of no consequence, and I would have let it go, except

13

it was a challenge to me. I wondered whether I could find one word which could be taken out without spoiling it,

14

so that I could kid Professor Chadwick about it.

15

"Well, do you know, I spent pretty near two days on that

16

manuscript without finding a single word that could be left out without injury

17

when I

18

came across

19

an "and" in the first paragraph

20

that could be substituted by a semicolon

21

without injuring neither sense nor style.

22

"I struck it out and was just planning what I would say to Professor Chadwick when this telegram arrived: 'Horried to find my abstract has 226 words. Kindly strike out "and" in first paragraph.'

23

1. It turned out to have 226 words.

- 2. I counted 226 words in it.
- 3. I counted the words—226 of them.
- 4. I counted the words and found 226.

12. 1. at least

- 2. truly
- 3. surely
- 4. undeniably

13. 1. except 2. although 3. but 4. only

- 14. 1. could be taken out without spoiling it
- 2. could be deleted
- 3. might be taken out
- 4. might better be deleted

15. 1. kid 2. josh 3. twit 4. tease

- 16. 1. pretty near
- 2. pretty close to
- 3. the better part of
- 4. practically

- 17. 1. without injury
- 2. without loss
- 3. without ruining it
- 4. OMIT

18. 1. when 2. , when 3. . Then 4. . Just then]

- 19. 1. came across
- 2. laid eyes on
- 3. spotted
- 4. tumbled to

- 20. 1. an "and"
- 2. an, "and,"
- 3. an 'and'
- 4. an, 'and'

- 21. 1. substituted
- 2. represented
- 3. replaced
- 4. supplanted

- 22. 1. neither sense nor style
- 2. neither the sense nor the style
- 3. the sense nor the style
- 4. either the sense or the style

- 23. 1. paragraph.'
- 2. paragraph."
- 3. paragraph.'"
- 4. paragraph.'"

Theme II

Students entering a university are liable to be amazed by their new freedom and responsibilities and to waste a great deal of time before settling down to work. Later they will regret it. Since no one among all the people they meet are willing to tuck them obligingly in at night, they may be homesick. They stay out too late at night. They can't hardly realize that they are on their own, irregardless of how many presents they get from home, or how many photos of relations and boy-friends and girl-friends they have in their rooms.

Once they settle down to work, they will snap out of their disinterested state. Then they will feel mighty relieved as if a burden had been lifted. They will know that, although they are not entirely independent from their families, that they have new freedom of thought and

action, they will form their own views. Especially will they feel liberated when they set a task for themselves' which manifests those kind of ideals which are worth fighting for, and when, like Oliver Wendell Holmes says, they have begun "to dig by the divining rod for springs which they may never reach." They will know then how they only have to look about them for problems, which they are capable of solving. Moreover, the problems both to be solved and those that reach no solution gives them a new sense of freedom. In turn, their new freedom will lead them into different attitudes than their earlier ones as related to wasting time. At first athletics were their chief interest. They may regret their wasted time, or they may see it as part of the enrichment inherent to a liberal education.

Mark the exercises as in Theme I.

Students entering a university
are liable to be

24

amazed by their new freedom

25

and responsibilities and to
waste a great deal of time before
settling down to work.

Later they will regret it.

26

Since no one among all the
people they meet
are willing to tuck them

27

obligingly in

28

24. 1. liable 2. due 3. likely 4. prone

25. 1. amazed
2. bewildered
3. discomfited
4. unadjusted

26. 1. Later they will regret it.
2. They will regret it later.
3. They will later regret it.
4. OMIT

27. 1. are 2. is 3. will be 4. have been

28. 1. obligingly in
2. in obligingly
3. in
4. away

29
they may be homesick.
They stay out too late
at night.

30
They can't hardly
31
realize that they are on
their own,
irregardless of how many

32
presents they get from home
or how many
photos of

33
relations and boy-friends
and girl-friends

34
they have in their rooms.
Once they settle down to work,
they will snap out of

35
their disinterested state.

36
Then they will feel
mighty relieved as if a burden

37
had been lifted. They will
know that, although they are not
entirely independent from

38
their families, that they have

39
new freedom of thought and
action, they will form their own views.

40
Especially will they feel
liberated when they set a task
for themselves' which manifests

41

- 30. 1. They stay out too late at night.
2. Some of them stay out too late at night.
3. They remain out too late.
4. OMIT

- 31. 1. can't hardly
2. can hardly
3. can never
4. dimly

- 32. 1. irregardless of
2. disregarding
3. in spite of
4. no matter

- 33. 1. photos
2. photographs
3. snaps
4. mementoes

- 34. 1. relations and boy-friends and girl-friends
2. relations, boy-friends and girl-friends
3. relatives, of boy-friends and of girl-friends
4. relatives and friends

- 35. 1. snap out of
2. get over
3. withdraw from
4. repudiate

- 36. 1. disinterested state
2. uninterested state
3. apathetic lethargy
4. lack of interest in their studies

- 37. 1. mighty 2. mightily 3. so 4. as

- 38. 1. from 2. on 3. of 4. toward

- 39. 1. that 2. yet 3. but 4. OMIT

- 40. 1. , they will form their own views.
2. ; they will form their own views.
3. , and they will form their own views.
4. . OMIT

- 41. 1. themselves'
2. themself's
3. themselves
4. theirselves

those kind of ideals which are

42

Approved For Release 1999/09/08 : CIA-RDP80-01826R001000010002-2

worth fighting for, and when,
like Oliver Wendell Holmes says,

43

they have begun "to dig by the

44

divining rod for springs which
they may never reach." They
will know then how they

45

only have to look about them

46

for problems, which they are

47

capable of solving. Moreover,

48

the problems both to be

49

solved and those that reach
no solution gives them a new

50

use of freedom. In turn,
their new freedom will lead
them into different attitudes

51

than their earlier ones

52

as related to wasting time.

53

At first athletics were their
chief interest.

54

They may regret their wasted
time, or they may see it as
part of the enrichment

55

inherent to

56

literal education.

57

43. 1. like 2. as 3. so 4. OMIT

44. 1. begun
2. began
3. made a start
4. essayed

45. 1. how 2. why 3. that 4. where

46. 1. only have
2. have only
3. ought only
4. are only

47. 1. , 2. : 3. — 4. no punctuation

48. 1. , 2. : 3. — 4. no punctuation

49. 1. the problems both
2. both the problems
3. the problems
4. the two problems

50. 1. gives 2. give 3. gave 4. have given

51. 1. different attitudes
2. attitudes different
3. differing attitudes
4. new attitudes

52. 1. than 2. to 3. from 4. toward

53. 1. as related
2. with regards
3. in regards
4. in regard

54. 1. At first athletics were their chief interest.
2. At first, athletics was their chief interest.
3. Athletics was at first their chief interest.
4. OMIT

55. 1. part of the enrichment
2. one of the advantages
3. one of the disadvantages
4. a consequence of the freedom

56. 1. to 2. from 3. in 4. of

57. 1. literal
2. literary
3. literate
4. liberal

Theme III

Possibly there are times while luxury and ease are things of which we may feel pride, but since Pearl Harbor we Americans know this is not one of those times. Today, anything which can be done for the war however unpleasantly it may strike us as being, satisfies us. It is when no one will tell us what to do, when our efforts seem futile we are most unhappy. That change—from enjoyment of ease to glory in work—results from the discipline of war. After the last war Americans “reacted” against those kind of things learned in the fight against the dirty

Huns. Small-time politicians insist, with very little reason probably, that we shall react again, the same way, today. When one considers how much our country, this great land of liberty, has changed in a single year of war, it would seem risky to make snap guesses as to what we will be like in the future. Perhaps, when the dove of peace again settles on this war-torn world, we Americans, remembering the boys who gave their all, will choose the opposing course, to apply the lessons of this struggle to build a strong and dynamic peace.

Mark the exercises as before.

Possibly there are times
while luxury and ease are things
58

of which we may feel pride,
59

but since Pearl Harbor we Americans
know this is not one of those
times. Today, anything
which can be done for the war ,
60 61

however unpleasantly it may strike
us as being ,
62 63

satisfies us. It is when no one
will tell us what to do, when our
efforts seem futile we are
64

most unhappy. That change—from
enjoyment of ease to glory in work—
results from the discipline of war.
After the last war Americans
“reacted” against
those kind of things
65

58. 1. while 2. when 3. that 4. during which

59. 1. of which we may feel pride
2. to be proud of
3. about which proudness may be felt
4. about which to be proud

60. 1. which can be done for the war
2. which actually we can do for the war
3. we can do for the war
4. which can actually be done by us for the war

61. 1. , 2. no punctuation

62. 1. however unpleasantly it may strike us as being
2. however unpleasant it may be
3. however unpleasantly
4. OMIT

63. 1. , 2. no punctuation

64. 1. futile we
2. futile that we
3. futile, that we
4. futile, we

65. 1. those kind of things
2. these kind of things
3. those things
4. those kinds of things

learned in the fight against
the dirty Huns.

66

Small-time politicians insist, with
very little reason probably,

67

that we shall react again, the
same way, today.

68

When one considers how much our
country, this great land of liberty,

69

has changed in a single year of war,
it would seem risky to make snap
guesses as to what we will be like
in the future. Perhaps, when the
dove of peace again settles on
this war-torn world,

70

we Americans, remembering the boys
who gave their all,

71

all choose the opposing course,
to apply the lessons of this

72

struggle to build a strong and
dynamic peace.

Approved For Release 1999/09/08 : CIA-RDP80-01826R001000010002-2

66. 1. the dirty Huns
2. the Hohenzollern imperialists
3. the German war lords
4. German imperialism
67. 1. , with very little reason probably,
2. , with probably very little reason,
3. , with little probable reason,
4. OMIT
68. 1. today
2. tomorrow
3. after this war
4. in the days ahead
69. 1. , this great land of liberty,
2. , this magnificent democracy,
3. , this great union,
4. OMIT
70. 1. when the dove of peace again settles on this war-torn world
2. when peace comes this time
3. when peace again returns to our war-weary world
4. upon the return of the dove of peace to our war-torn world
71. 1. their all
2. all they hold most dear
3. their lives
72. 1. to apply
2. applying
3. to applying
4. making application of

Theme IV

"So you found the Odyssey dull," said Professor Palmer. "That is a pity. For three thousand years people have thought it was interesting, but perhaps we have learned to write more exciting tales at this time. On the other hand, perhaps we do not read with enough skill. We are used to books where the author explains all mysteries. The older classics, Greek especially, let the reader solve them for themselves."

"Let me find a passage to show you what I mean," he said, turning over the pages rapidly. "Ah! Here is one that will do. It is that in which Nausicaa says good-bye to Odysseus. Odysseus has been trying to get home from the Trojan War for ten years. He is shipwrecked near the island of the Pheacians, he spends two days in the water, and finally gets ashore and falls asleep. Nausicaa, the daughter of the king, is washing clothes nearby, finds Odysseus, gives him food and clothing, and tells him how to get a ship to take him home."

"Odysseus is on his way to a farewell banquet when Nausicaa meets him. She says, 'Stranger, when you get to your own country, remember me.' Odysseus replies,

'Princess, I will honor you next after my own mother, for she gave me life first, and you gave it back to me again.'

"That is all. At first glance, a superficial incident. But let us figure out what probably went on behind the scenes. Ever since Nausicaa was first brought on the scene, we caught glimpses of how much she admired Odysseus, she being too shy to speak to him. When he came to the banquet, it was no chance matter that she connected with him. She had probably been waiting a long time. Upon seeing him, it was nip and tuck whether she would speak to him or run away. She made her little speech with her heart pounding, not daring to hint in any other way that she loved him."

"Odysseus was a suave diplomat who knew what to say in every situation. He waited just long enough to make his smooth reply, which, by placing her in the same category as his mother, he gently blocked any further attention."

"That evening the Pheacians took him home. And Nausicaa? My guess is that she went to bed and cried herself to sleep."

Mark the exercises as before.

"So you found the Odyssey dull," said Professor Palmer. "That is a pity. For three thousand years people have thought it was

73

interesting, but perhaps we have learned to write more exciting tales at this time.

74

On the other hand, perhaps we do not read with enough skill.

75

73. 1. thought it was
2. thought it to be
3. found it
4. supposed it
74. 1. at this time
2. in these times
3. in this day and age
4. in the modern era
75. 1. skill
2. exactitude
3. imagination
4. patience

We are used to books where the

76

author explains all
mysteries.

The older classics,
Greek especially,

77

let the reader solve them for
themselves.

78

"Let me find a passage to show
you what I mean," he said,
turning over the pages rapidly.

79

"Ah! Here is one that will do.
It is that in which

80

Nausicaa says good-bye to
Odysseus. Odysseus has been
trying to get home from the
Trojan War for ten years.

81

He is shipwrecked near the
island of the Pheacians,
he spends two days in the
82

water, and finally gets
ashore and falls asleep.

Nausicaa, the daughter of
the king, is washing clothes
nearby, finds Odysseus,

83

gives him food and clothing,
and tells him how to get a
ship to take him home.

"Odysseus is on his way to a
farewell banquet when Nausicaa
meets him. She says, 'Stranger,
when you get to your own country,
remember me.' Odysseus replies,
'Princess, I will honor you next
after my own mother, for she
gave me life first,

84

76. 1. where
2. of which
3. in which
4. for which

77. 1. Greek especially
2. especially Greek
3. especially the Greek
4. specifically the Greek

78. 1. themselves
2. themselves'
3. themselves
4. himself

79. 1. turning over the pages rapidly
2. turning rapidly over the pages
3. while turning pages
4. scanning over the book

80. 1. that in which
2. the scene in which
3. the time at which
4. the place that

81. 1. (Leave where it is now.)
2. (Place after "Odysseus.")
3. (Place after "has.")
4. (Place after "trying.")

82. 1. he 2. then 3. and 4. OMIT

83. 1. , finds
2. ; finds
3. , and finds
4. . She finds

84. 1. (Leave where it is now.)
2. (Place after "for.")
3. (Place after "she.")
4. OMIT

and you gave it back to me again.

"That is all. At first glance,

85

a superficial incident.

86

But let us figure out

87

what probably went on

88

behind the scenes. Ever since

Nausicaa was first

brought on the scene,

89

we caught glimpses of how much

she admired Odysseus, she being

90

too shy

to speak to him. When he came

to the banquet, it was no

chance matter

91

that she connected with

92

him. She had probably been

waiting a long time.

Upon seeing him, it was

93

nip and tuck whether she would

speak to him or run away. She

made her little speech

with her heart pounding,

94

85. 1. . At 2. —at 3. :at 4. ;at

86. 1. a superficial
2. a trivial
3. an uninteresting
4. a mere

87. 1. figure out
2. piece together
3. see
4. imagine

88. 1. went on
2. transacted
3. was brewing
4. was at stake

89. 1. brought on the scene
2. involved
3. seen
4. introduced

90. 1. she being
2. being
3. since she was
4. but she was

91. 1. chance matter
2. coincident
3. matter of luck
4. accident

92. 1. connected with
2. ran into
3. ran across
4. met

93. 1. Upon seeing him
2. At the sight of him
3. Seeing him
4. When she saw him

94. 1. with her heart pounding
2. her heart wildly beating
3. in a panic
4. emotionally upset

not daring to say
other way that she loved him.
"Odysseus was a suave diplomat
who knew what
95

to say in every situation. He
waited just long
96

enough to make his smooth reply,
which, by placing her in the
same category
as his mother, he gently
97

blocked any further attention.
98

"That evening the Pheacians took
him home. And Nausicaa?
99

My guess is that she went to bed
and cried herself to sleep."
100

- 95. 1. what
2. just what
3. the right thing
4. something
- 96. 1. waited
2. paused
3. postponed his dinner
4. waited for her
- 97. 1. he gently
2. he completely
3. he perfectly
4. perfectly
- 98. 1. attention
2. reply
3. talk
4. conversation
- 99. 1. . And Nausicaa?
2. with Nausicaa.
3. from Nausicaa.
4. . How about Nausicaa?
- 100. 1. herself to sleep
2. her eyes out
3. for several hours
4. to her heart's content

FORM A	Published by	Possible Score	130
	Bureau of Educational Measurements	Number wrong	
	Kansas State Teachers College, Emporia	and omitted	
	BENNETT USE OF LIBRARY TEST	FINAL SCORE	
High School and College	By Alma Bennett, Kellogg Library, and H. E. Schrammel,		
Time: 50 Minutes	Bureau of Educational Measurements, Kansas State Teachers College, Emporia, Kansas		

Name Age Grade

School State Date

PART I

The Book

DIRECTIONS: Read the following sentences carefully. If a statement is true, place a plus (+) in the parenthesis before the statement, as in example A below. If the statement is false, make a minus (-) in the parenthesis, as in example B.

Examples: (+) A. America was discovered by Columbus.
 (-) B. The first president of the United States was Lincoln.

- () 1. The appendix of a book contains additional material not included in the text of the book.
- () 2. The full name of the publisher is found on the title page.
- () 3. If one wishes to learn quickly on which page a certain item appears, he should consult the bibliography.
- () 4. The date at the bottom of a title page always tells how old the material is in the book.
- () 5. The author of a book is the person who has written it.
- () 6. The preface lists in strict alphabetical order all the important topics, names, and terms which are discussed in a book.
- () 7. No book should be carried from the library until it is signed for and stamped.
- () 8. Fiction books frequently have indexes.
- () 9. It is of no importance to know the name and publisher of a book.
- () 10. The index of a book is usually in the back.
- () 11. The quickest way to find material in a reference book that is not indexed is to consult the introduction.
- () 12. The index is an alphabetical list of the things described, explained, or alluded to in a book, with the numbers of the pages on which they are mentioned.
- () 13. The introduction of a book gives a general discussion of the subject matter of the book, preparing the reader for the material taken up in the body of the book.
- () 14. The copyright date and the date of publication are always the same.
- () 15. The number of the edition of a book usually appears on the reverse of the title page.

PART II

The Catalog

Section A

DIRECTIONS: Some of the following statements are true; some of them are false. When a statement is true, mark it with a (+); when it is false, mark it with a (-).

- () 16. There are author cards in the catalog for every writer who has books in the library.
- () 17. The labels on the outside of the catalog drawers indicate the part of the alphabet which is included in each drawer.
- () 18. The articles "a," "an," and "the" are disregarded except when they occur at the beginning of titles.
- () 19. Fiction books do not usually have Dewey Decimal classification numbers.
- () 20. A card for a book about Edgar Allan Poe will be filed in front of a card for a book by Edgar Allan Poe.
- () 21. Cards in the dictionary card catalog are filed in straight alphabetical order.
- () 22. The card catalog gives information as to date of publication of a book.
- () 23. Abbreviations in titles, names, etc. are usually regarded as if spelled in full when they need to be considered in the alphabetical arrangement in the card catalog.
- () 24. The "see also" cross reference card is an aid to further reading on a subject.
- () 25. Books by Mark Twain will be found both under Twain (pen name) and Clemens, a real name.
- () 26. Library books are arranged on the shelves according to size.
- () 27. For individual biographies and autobiographies some libraries use B instead of a number.
- () 28. Most non-fiction books have at least three cards in the card catalog.
- () 29. A card saying "Exports see Commerce" means that there is no material in the library on "Exports."

Section B

DIRECTIONS: Listed below are some of the main headings of the Dewey Decimal classification such as might appear on the library book shelves. Below the headings are ten topics on which you might want information. If you know under which heading each topic belongs, you could go directly to the shelf for the book you want. In the space at the left of each topic write the number of the heading that best covers the topic. Use one number only for each topic and use no number more than once. Note the example.

Example: (913) The ruins of Rome

- | | |
|----------------------------|----------------------------|
| 220 Bible | 640 Home economics |
| 290 Non-Christian religion | 720 Architecture |
| 320 Political science | 730 Sculpture |
| 330 Economics | 750 Painting |
| 350 Administration | 760 Engraving |
| 390 Customs and folklore | 770 Photography |
| 530 Physics | 780 Music |
| 540 Chemistry | 800 Literature |
| 550 Geology | 910 Geography |
| 580 Botany | 913 Archaeology |
| 590 Zoology | 930 Ancient history |
| 620 Engineering | 942 English history |
| 630 Agriculture | 970 North American history |

- () 30. The westward expansion of the United States.
- () 31. Theories of money.
- () 32. Gothic building.
- () 33. Cookery.
- () 34. The growth of the ancient Roman Empire.
- () 35. The Restoration period in England.
- () 36. The opera "Faust."
- () 37. Soy beans.
- () 38. A commentary on the Bible.
- () 39. Myths of Greece and Rome.

Section C

DIRECTIONS: Each of the following statements lists a topic on which you might wish to find a book, together with the possible word under which to look for it in the card catalog. For each, write the number of the best answer in the blank at the left.

- () 40. Frontier and pioneer life: 1. Border life. 2. Frontier and pioneer life. 3. Pioneer life. 4. Adventure and adventurers. 5. Ranch life.
- () 41. Diesel engines: 1. Engines. 2. Diesel engines. 3. Gas and oil engines. 4. Motors. 5. Locomotives.
- () 42. Community centers: 1. Play centers. 2. Recreation centers. 3. Social problems. 4. Social settlements. 5. Community centers.
- () 43. Chemical industries: 1. Chemical technology. 2. Industrial chemistry. 3. Technical chemistry. 4. Chemistry, Technical. 5. Engineering chemistry.
- () 44. Cotton boll weevil: 1. Mexican boll weevil. 2. Boll weevil. 3. Pests. 4. Weevils. 5. Insects.
- () 45. Bacteria: 1. Bacilli. 2. Disease germs. 3. Bacteriology. 4. Microbes. 5. Preventive medicine.
- () 46. Arctic expeditions: 1. Polar expeditions. 2. Arctic regions. 3. Discoveries. 4. Earth. 5. North Pole.
- () 47. Labor strikes: 1. Conciliation, Industrial. 2. Industrial relations. 3. Strikes and lock-outs. 4. Labor and laboring classes. 5. Capital and labor.
- () 48. Fashions: 1. Style in dress. 2. Clothing and dress. 3. Fashion. 4. Costume. 5. Dressmaking.
- () 49. Delinquent children: 1. Crime and criminals. 2. Juvenile delinquency. 3. Delinquency, Juvenile. 4. Reformatories. 5. Defective and delinquent classes.

Section D

DIRECTIONS: In the column to the right are some common library terms. In the column to the left are definitions for those terms. Match the terms to the definitions by placing the number for the term in the blank at the left of the corresponding definition.

Column I

Column II

- | | |
|---|----------------------|
| () 50. That part of a book's call number which represents the author's name. | 1. author number |
| () 51. Reference made from one part of a book or card catalog, to another where the same or allied subject is treated. | 2. binding |
| () 52. Refers from word not used to another. | 3. call number |
| () 53. List of books as they stand on the shelves. | 4. class numbers |
| () 54. The combination of numbers which indicate the location of a library book. | 5. cross reference |
| () 55. Author's pen name. | 6. open entry |
| () 56. That part of a call number which indicates the subject of a book. | 7. pseudonym |
| () 57. Subject card for a part of the book. | 8. secondary entry |
| () 58. The cover of a book. | 9. see reference |
| () 59. An entry for a serial which has not ceased publication. | 10. shelf list |
| () 60. A card with the subject heading printed or typed on the top line. | 11. subject analytic |
| () 61. Any entry other than the main author entry. | 12. subject card |

Section E

DIRECTIONS: Below you will find the titles or descriptions of books with a list of possible words under which you would find each in the card catalog. For each write the number of the best answer in the parenthesis at the left.

- () 62. The call number for a book entitled *Girls at Work in Aviation* written by Dickey Meyer, a pseudonym for Georgette Louise (Meyer) Chappelle: 1. Chappelle. 2. Dickey. 3. Louise. 4. Georgette. 5. Meyer.
- () 63. A book entitled *Her Son's Wife* by Dorothea Francis (Canfield) Fisher: 1. Son's. 2. Canfield. 3. Francis. 4. Wife. 5. Fisher.
- () 64. A book by Annie (Wilhelm) Williams-Heller and Josephine (Vercelli) McCarthy entitled *Soybeans From Soup to Nuts*: 1. Vercelli. 2. Heller. 3. Soup. 4. William-Heller. 5. Wilhelm.
- () 65. A book entitled *Democracy, Efficiency, Stability; An Appraisal of American Government*: 1. Stability. 2. Government. 3. American government. 4. Democracy. 5. Efficiency.
- () 66. The book entitled *1001 Christmas Facts and Fancies*: 1. Noa-Pap. 2. Cha-Cis. 3. Fab-Fas. 4. Aab-Art. 5. Fat-Fay.
- () 67. A book entitled *The Fight For Life* by Paul Henry De Kruif: 1. Kruif. 2. Life. 3. De Kruif. 4. Henry. 5. Paul.
- () 68. A book entitled *With the Turks in Thrace* by Ellis Ashmead-Bartlett: 1. Bartlett. 2. Ellis. 3. Ashmead-Bartlett. 4. Turks. 5. Thrace.
- () 69. A book entitled *The Forge In the Forest*: 1. Forge. 2. Blacksmiths. 3. Forests and forestry. 4. Forest. 5. Fiction.
- () 70. A book by Willard De Mille Price entitled *Japan Rides the Tiger*: 1. Price. 2. De Mille. 3. Willard. 4. Mille. 5. Tiger.
- () 71. A book by Seymour Van Santvoord entitled *Octavia; a Tale of Ancient Rome*: 1. Seymour. 2. Van Santvoord. 3. Santvoord. 4. Fiction. 5. Ancient history.

PART III

Reference Books

Section A

DIRECTIONS: Some of the following statements are true; some of them are false. When a statement is true, mark it with a (+); when it is false, mark it with a (-).

- () 72. The Congressional Directory is a government document.
- () 73. Current Biography contains biographies of persons both living and dead.
- () 74. The Encyclopedia Americana is more scholarly than the Encyclopaedia Britannica.
- () 75. Unusual and obsolete words may be found below the line in the New Standard Dictionary.
- () 76. The biography of the prime minister of England will be found in Who's Who in America.
- () 77. If you look up Robert Louis Stevenson in the dictionary and in the encyclopedia, the longer account will be found in the dictionary.
- () 78. The Statesman's Yearbook contains no biographical notes.
- () 79. The World Almanac is a book of facts published annually.
- () 80. Larned's New History For Ready Reference is a good source for recent world events.
- () 81. To use Who's Who in America one must consult the index.
- () 82. The Readers' Guide contains digests of magazine articles.
- () 83. Three important points to consider when buying an encyclopedia are: date, reliability, and arrangement.
- () 84. The "fact index" is a feature of Compton's Pictured Encyclopedia.
- () 85. Biography is not a feature of the Statesman's Yearbook.
- () 86. The World Book Encyclopedia contains no illustrations.
- () 87. The Lincoln Library of Essential Information is arranged alphabetically.
- () 88. The Congressional Directory contains biographies of government officials.
- () 89. The index in Bartlett's Familiar Quotations is by subject.
- () 90. To use The World Almanac one must consult the index.
- () 91. The World Book Encyclopedia is arranged alphabetically.
- () 92. The words at the top of the page of a dictionary are called "guide" words.
- () 93. Complete poems are printed in Granger's Index to Poetry and Recitations.
- () 94. A biography of the painter Murillo may be found in Grove's Dictionary of Music and Musicians.
- () 95. A key to the abbreviations of the names of magazines used in the Readers' Guide is given in the front of each issue.
- () 96. The Statesman's Yearbook contains no information on commerce.

Section B

DIRECTIONS: Listed below are some types of information you might want to locate together with several books in which you might look. For each write the number of the best answer in the blank space at the left.

- () 97. To find a list of magazine articles published in 1919 on the Versailles Treaty, you would consult: 1. The Encyclopaedia Britannica. 2. The Reader's Guide. 3. Larned's New History for Ready Reference. 4. the card catalog. 5. Webster's New International Dictionary.
- () 98. The purposes, powers and personnel of the United States Government War Agencies of World War II may be found in the: 1. Congressional Directory. 2. Government Manual. 3. Statesman's Yearbook. 4. Encyclopaedia Britannica. 5. World Almanac.
- () 99. A list of representative publications of departments and agencies of the federal government may be found in: 1. Larned's New History for Ready Reference. 2. Statesman's Yearbook. 3. Government Manual. 4. American Encyclopedia. 5. Congressional Directory.
- () 100. For a discussion of the life and works of Beethoven one should consult: 1. Current Biography. 2. a daily newspaper. 3. Granger's Index to Poetry and Recitations. 4. Grove's Dictionary of Music and Musicians. 5. Who's Who.
- () 101. The population of Topeka, Kansas, may be found in the New Standard Dictionary in the: 1. main alphabet. 2. foreign words and phrases. 3. disputed pronunciations. 4. key to abbreviations. 5. statistics of population.
- () 102. The 1944 platforms of both the Republican and Democratic political parties may be found in: 1. Government Manual. 2. Current Biography. 3. Encyclopedia Americana. 4. Lincoln Library. 5. World Almanac.
- () 103. An authoritative bibliography for each country described is given in the: 1. World Almanac. 2. Government Manual. 3. Statesman's Yearbook. 4. Congressional Directory. 5. Current Biography.
- () 104. To find the author and title of the poem beginning "Dear charming, nymph, neglected and derided" look in: 1. Compton's Pictured Encyclopedia. 2. Bartlett's Familiar Quotations. 3. Granger's Index to Poetry and Recitation. 4. The World Book. 5. Encyclopedia Americana.
- () 105. A history of Alaska told by quotations (exerpts) from the writings of several historians may be found in: 1. Statesman's Yearbook. 2. Encyclopedia Americana. 3. Larned's New History for Ready Reference. 4. World Almanac. 5. Congressional Directory.
- () 106. A biographical note on Jane Addams may be found in the New Standard Dictionary in the: 1. main alphabet. 2. foreign words and phrases. 3. biographical section. 4. statistics of population. 5. rules for simplification of spelling.
- () 107. The "Boston Massacre" may be found in Webster's New International Dictionary 2nd ed. in the: 1. main alphabet. 2. Gazetteer. 3. new words section. 4. main alphabet below the line. 5. biographical dictionary.
- () 108. A table showing the rank in population of the largest cities of the United States is the: 1. Government Manual. 2. Congressional Directory. 3. World Almanac. 4. Webster's New International Dictionary.
- () 109. The definition of "coup d'etat" may be found in Webster's New International Dictionary in the: 1. Gazetteer. 2. new words. 3. pronouncing bio-

- graphical dictionary. 4. rules for pronunciation. 5. main alphabet.
- () 110. Maps showing the congressional districts of the states may be found in the: 1. Government Manual. 2. Statesman's Yearbook. 3. Congressional Directory. 4. World Almanac. 5. Encyclopedia Americana.
- () 111. A list of presidents of the Argentine Republic from 1898 to 1944 may be found in the: 1. Larned's New History for Ready Reference. 2. Encyclopedia Americana. 3. Government Manual. 4. World Almanac. 5. Statesman's Yearbook.
- () 112. To find the author and location of the poem whose title is "The Lotus Eaters" one would look in: 1. Reader's Guide. 2. Granger's Index to Poetry and Recitations. 3. Bartlett's Familiar Quotations. 4. Encyclopedia Americana. 5. Grove's Dictionary of Music and Musicians.
- () 113. Brief biographies of members of Congress may be found in the: 1. Encyclopedia Americana. 2. Congressional Directory. 3. World Almanac. 4. U.S. Government Manual. 5. Statesman's Yearbook.
- () 114. To locate the poem whose title is "Song of the Camels" by Elizabeth Coatsworth look in the: 1. Reader's Guide. 2. Bartlett's Familiar Quotations. 3. Granger's Index to Poetry and Recitations. 4. The World Book. 5. Encyclopedia Americana.
- () 115. An article on international arbitration from ancient to modern times may be found in the: 1. World Almanac. 2. Statesman's Yearbook. 3. Government Manual. 4. Larned's New History for Ready Reference. 5. Congressional Directory.
- () 116. Statistics showing the production of raw sugar for the years 1930 through 1943 may be found in the: 1. Statesman's Yearbook. 2. Larned's New History for Ready Reference. 3. World Almanac. 4. Lincoln Library. 5. Reader's Guide.
- () 117. The meaning of *capitis diminutio* may be found in The New Standard Dictionary in the: 1. Statistics of population. 2. foreign words and phrases. 3. key to abbreviations. 4. main alphabet. 5. Gazetteer.
- () 118. The definition of NIRA may be found in Webster's New International Dictionary in the: 1. main alphabet. 2. pronouncing biographical dictionary. 3. arbitrary signs and symbols. 4. abbreviations. 5. Gazetteer.
- () 119. For a description of the musical instrument, pianoforte, one should consult the: 1. World Almanac. 2. Grove's Dictionary of Music and Musicians. 3. Granger's Index to Poetry and Recitations. 4. Bartlett's Familiar Quotations. 5. Readers' Guide.
- () 120. For a map of Oceania, one should consult the: 1. Rand-McNally Atlas. 2. Statesman's Yearbook. 3. A geography textbook. 4. National Geographic Magazine. 5. New Standard Dictionary.

Section C

DIRECTIONS: The following entries appear in the Readers' Guide for June 1944-October 1944. By means of them you could find articles in magazines. Numbers have been placed in parentheses above portions of the information contained in the entries. Below are questions about the entries. Answer them by writing the number of the correct item from the Readers' Guide in the blank space at the left. For each use one number only and do not use the same number twice.

- (1)
Brummel, Belle, pseud. See Worden, H.
- (2)
Dams
By a damsite; Shasta is Frank Crowe's 19th dam and the World's second biggest concrete structure. il Time 43: 79-80 Je 19 '44
- (3)
World's second biggest concrete structure. il Time 43: 79-80 Je 19 '44
- (4)
79-80 Je 19 '44
- (5)
Davis, Forrest
Dewey's April choice. Sat Eve Post 217:9-10+ Ag 12 '44
- (6)
Dewey's April choice. Sat Eve Post 217:9-10+ Ag 12 '44
- (7)
Sat Eve Post 217:9-10+ Ag 12 '44
- (8)
Ag 12 '44
- (9)
Dulles, John Foster
Biography, por Cur Blog Ag '44
- (10)
Cur Blog Ag '44
- (11)
Mr. Hull and Mr. Dulles. por Time 44:22 S 4 '44
- (12)
Dzhugashvili, Iosif Vissarionovich. See Stalin, I. Education, Elementary
- (13)
Present problems facing the elementary school. V. E. Hier-rick. tab. El Sch J 43: 513-19; 44: 575-82; My '43, Je '44
- (14)
Little ride; story. See Lyons, R.
- () 121. Find an article continued in succeeding issues of a magazine.
- () 122. What person is the subject of an article.
- () 123. Find an author entry.
- () 124. Find an article that includes a portrait of the subject.
- () 125. What symbol is used to indicate that the paging is not inclusive.
- () 126. Find an illustrated article.
- () 127. Find the title of a story.
- () 128. Find a subject entry.
- () 129. What is the title of a weekly magazine.
- () 130. How is a pseudonym indicated.



THE UNITED STATES ARMED FORCES INSTITUTE

Examination in FRENCH READING COMPREHENSION—Lower Level
Form LFR—I-B-4

DIRECTIONS: You have 50 minutes for this test. As you answer the questions, you should omit any that seem unusually difficult until you finish the others.

Your answers to the exercises in this test are to be recorded on the separate ANSWER SHEET which is loosely inserted in this test booklet. Remove this answer sheet now; write your name and the other information called for in the blanks at the top of the answer sheet; then finish reading these directions.

After the number on the answer sheet corresponding to that of each exercise, mark the one lettered space which designates the answer you have selected as correct. If your answer sheet contains rows of squares, indicate each answer with a cross (X), for example,

A	B	C	D	E
☒	☐	☐	☐	☐

If your answer sheet contains rows of paired dotted lines, indicate each answer with a heavy black mark with the special pencil, for example,

A	B	C	D	E

Avoid resting the point of your pencil on the answer sheet while you are considering your answer. Do not make unnecessary marks. If you change an answer, erase your first mark completely. Do not fold or crease your answer sheet.

EXAMPLES

Les Français parlent toujours légèrement de leurs malheurs, dans la crainte d'ennuyer leurs amis; ils devinent la fatigue qu'ils pourraient causer, par celle dont ils seraient susceptibles; ils se hâtent de montrer élégamment de l'insouciance [carelessness] pour leur propre sort, afin d'en avoir l'honneur au lieu d'en recevoir l'exemple. Le désir de paraître aimable conseille de prendre une expression de gaieté, quelle que soit la disposition intérieure de l'âme; au reste la physionomie influe par degrés sur ce qu'on éprouve, et ce qu'on fait pour plaire aux autres affaiblit bientôt en soi-même ce qu'on ressent.

0. On explique dans ce passage

- A. comment les Français n'aiment pas cacher leurs propres sentiments à autrui
- B. un manque apparent de sérieux chez les Français
- C. pourquoi les Français sont si susceptibles à l'insouciance de leurs amis

[The correct answer is B; therefore, answer space B would be marked on the answer sheet.]

00. Selon l'auteur, les Français ont l'habitude

- A. de partager leurs ennuis et leurs douleurs avec autrui
- B. d'exprimer à leurs amis leur ressentiment contre le sort
- C. de faire semblant d'être gais quand ils ne le sont plus

[The correct answer is C; therefore, answer space C would be marked on the answer sheet.]

Prepared by the
EXAMINATIONS STAFF FOR THE UNITED STATES ARMED FORCES INSTITUTE

Published by
THE AMERICAN COUNCIL ON EDUCATION

Distributed by
THE AMERICAN COUNCIL ON EDUCATION
15 Amsterdam Avenue, New York 23

SCIENCE RESEARCH ASSOCIATES
228 South Wabash Avenue, Chicago 4

Copyright, 1944
THE AMERICAN COUNCIL ON EDUCATION
SECOND PRINTING

ORDER NO. 415

I. Après la bataille

Mon père, ce héros au sourire si doux,
Suivi d'un seul housard [hussar] qu'il aimait entre tous
Pour sa grande bravoure et pour sa haute taille,
Parcourait à cheval, le soir d'une bataille,
Le champ couvert de morts sur qui tombait la nuit.
Il lui sembla dans l'ombre entendre un faible bruit.
C'était un Espagnol de l'armée en déroute
Qui se traînait sanglant sur le bord de la route,
Râlant [with the death-rattle in his throat], brisé, livide, et
mort plus qu'à moitié,
Et qui disait:—A boire, à boire, par pitié!—
Mon père, ému, tendit à son housard fidèle
Une gourde de rhum qui pendait à sa selle [saddle].
Et dit:—Tiens, donne à boire à ce pauvre blessé.—
Tout à coup, au moment où le housard baissé
Se penchait vers lui, l'homme, une espèce de Maure [Moor],
Saisit un pistolet qu'il étreignait [gripped] encore,
Et vise au front mon père en criant: Caramba!
Le coup passa si près que le chapeau tomba
Et que le cheval fit un écart en arrière.
—Donne-lui tout de même à boire, dit mon père.

1. La bataille avait eu lieu

- A. avant la nuit
- B. au soir
- C. au lever du soleil

2. Dans cette bataille il y avait eu

- A. peu d'hommes tués
- B. beaucoup de morts
- C. toute une armée massacrée

3. L'armée espagnole

- A. avait gagné la bataille
- B. avait résisté jusqu'au dernier soldat
- C. avait été vaincue

4. L'Espagnol

- A. était légèrement blessé
- B. se portait très mal
- C. disait ses prières

5. Le père du poète

- A. eut pitié de cet ennemi abattu
- B. craignit de donner à boire à l'Espagnol
- C. n'aimait pas le rhum

6. L'Espagnol

- A. remercia très poliment le père du poète
- B. resta sans rien faire
- C. manqua de reconnaissance

7. Le père du poète, se voyant accueilli ainsi,

- A. haussa les épaules
- B. se montra généreux
- C. devint furieux

8. Le poète

- A. admire le geste de son père
- B. blâme l'imprudence de son père
- C. trouve toute cette histoire très bête

II

«La comtesse de Turgis! Qu'elle est belle aujourd'hui!» murmuraient les courtisans. Et chacun se pressait pour la mieux voir. Mergy, qui se trouva sur son passage, fut tellement frappé de sa beauté, qu'il resta immobile, et ne pensa à se ranger pour lui faire passage que lorsque la robe de la comtesse toucha son pourpoint [doublet].

Elle remarqua son émotion, peut-être avec plaisir, et daigna fixer un instant ses beaux yeux sur ceux de Mergy, qui si baissèrent aussitôt, tandis que ses joues se couvraient d'une vive rougeur. La comtesse sourit, et en passant laissa tomber un de ses gants devant notre héros, qui, toujours immobile et hors de lui, ne pensa pas même à le ramasser. Aussitôt un jeune homme blond (ce n'était autre que Comminges), qui se trouvait derrière Mergy, le poussa rudement pour passer devant lui, se saisit du gant, et, après l'avoir baisé avec respect, le remit à madame de Turgis. Celle-ci, sans le remercier, se tourna vers Mergy, qu'elle regarda quelque temps, mais avec une expression de mépris écrasante: puis remarquant auprès de lui le capitaine Georges:

«Capitaine,» dit-elle très haut, «dites-moi d'où nous vient ce grand idiot? Sûrement c'est quelque huguenot, à en juger par sa politesse.»

Un éclat de rire général acheva de déconcerter le malheureux qui en était l'objet.

«C'est mon frère, Madame,» répondit Georges un peu moins haut; «il est à Paris depuis trois jours, et, sur mon honneur, il n'est pas plus maladroit que n'était Lannoy avant que vous ne prissiez soin de le former.»

Le comtesse rougit un peu.

«Capitaine, voilà une méchante plaisanterie. Ne parlez pas mal des morts. Tenez, donnez-moi la main; j'ai à vous entretenir de la part d'une dame qui n'est pas trop contente de vous.»

9. La dame qui entra

- A. baissa aussitôt les yeux
- B. était plus que jolie
- C. riait aux éclats

10. Mergy

- A. fit semblant de ne pas voir Mme de Turgis
- B. regarda d'un mauvais oeil le jeune homme blond
- C. resta sans pouvoir dire un mot

11. Mme de Turgis

- A. remercia Mergy de sa politesse
- B. regretta d'avoir laissé tomber son gant
- C. témoigna à ce jeune inconnu un profond mépris

12. Etant ainsi signalé à l'attention générale, Mergy

- A. éclata de rire
- B. se sentit plus timide que jamais
- C. devint de plus en plus hardi

13. Le capitaine Georges

- A. ne laissa pas maltraiter son frère
- B. trouva fort plaisants les propos de Mme de Turgis
- C. ne voulut pas dire du mal des morts

14. Celui qui ramassa le gant de Mme de Turgis, ce fut

- A. Mergy
- B. Comminges
- C. le capitaine Georges

III

Je me rappelle une petite histoire à propos d'une actrice de ce temps-là qui s'appelait Mlle Georges. Celle-ci, après avoir abandonné le Théâtre Français, ayant fait un brillant mariage, fut obligée, après quelques années d'union, sentant le manque d'argent venir dans son foyer, de reparaitre au théâtre; mais l'âge, et surtout la chair abondante, ayant quelque peu endommagé l'esthétique de la célèbre comédienne, c'est au Théâtre de la Porte Saint-Martin qu'elle reparut, dans un drame de sa création.

Dans un acte de cette pièce, après une scène violente que lui faisait son amant, elle tombait à terre; son amant devait relever sa partenaire évanouie et la porter dans un pavillon situé au fond de la scène. Un soir, fatigué peut-être, il fit un effort désespéré pour la relever. En voyant cela, un gamin cria de sa place au balcon: «Idiot, fais-en deux voyages!» Cette boutade amusa beaucoup le public; on dut baisser le rideau pour rétablir l'ordre. Et Mlle Georges dut quitter définitivement le théâtre après cette représentation, brisée à tout jamais.

15. Mlle Georges revint sur la scène,
 - A. parce que tout n'allait pas tout à fait bien chez elle
 - B. parce que sa maison était mal chauffée
 - C. parce qu'en principe elle désapprouvait le mariage
16. Elle reparut au Théâtre de la Porte Saint-Martin, parce qu'
 - A. elle aurait eu à payer au Théâtre Français, une indemnité
 - B. elle n'avait plus tout ce qu'il fallait pour briller au Théâtre Français
 - C. elle regrettait que le Théâtre Français eût abaissé le niveau de l'art dramatique
17. Elle tomba par terre au milieu de la pièce,
 - A. parce qu'elle ne pouvait pas supporter les reproches que lui faisaient les autres acteurs
 - B. parce que la gaieté du public l'avait gênée tout à fait
 - C. parce que cela faisait partie de son jeu de scène
18. Dès que son partenaire vit ce qui était arrivé,
 - A. il appela au secours
 - B. il voulut la consoler
 - C. il essaya de la soulever dans ses bras
19. Voyant cela, un petit garçon
 - A. trouva un bon mot qui fit rire tout le monde
 - B. offrit à l'acteur un conseil fort utile
 - C. baissa le rideau pour sauver la situation

IV

En causant ainsi ils arrivèrent à Portsmouth; une multitude de peuple couvrait les quais, et regardait attentivement un assez gros homme qui était à genoux, les yeux bandés, sur le pont d'un des vaisseaux de la flotte [fleet]; quatre soldats, postés vis-à-vis de cet homme, lui tirèrent chacun trois balles dans le crâne le plus paisiblement du monde, et toute l'assemblée s'en retourna extrêmement satisfaite. «Qu'est-ce donc que tout ceci? dit Candide, et quel démon exerce partout son empire?» Il demanda qui était ce gros homme qu'on venait de tuer en cérémonie. «C'est un amiral, lui répondit-on. —Et pourquoi tuer cet amiral? —C'est, lui dit-on, parce qu'il n'a pas fait tuer assez de monde; il a livré un combat à un amiral français, et on a trouvé qu'il n'était pas assez près de lui. —Mais, dit Candide, l'amiral français était aussi loin de l'amiral anglais que celui-ci l'était de l'autre! —Cela est incontestable, lui répliqua-t-on; mais dans ce pays-ci il est bon de tuer de temps en temps un amiral pour encourager les autres.»

20. Tout le monde s'était assemblé sur les quais pour
- voir décorer l'amiral
 - entendre un discours de l'amiral
 - assister à l'exécution de l'amiral
21. L'amiral était un homme
- assez mince
 - très maigre
 - un peu gras
22. Pendant la cérémonie l'amiral
- était agenouillé
 - était couché sur le dos
 - se tenait debout
23. L'amiral reçut des soldats
- douze balles
 - quatre balles
 - trois balles
24. L'amiral reçut les balles des soldats
- dans la tête
 - dans le ventre
 - dans le dos
25. En voyant ce spectacle, l'assemblée se montra
- très contente
 - peu satisfaite
 - assez déçue
26. Après avoir assisté à cette scène, Candide
- renseigna tout le monde sur ce qui venait de se passer
 - chercha à se l'expliquer
 - fit un discours
27. On avait traité ainsi l'amiral parce que, dans le combat, celui-ci
- s'était montré beaucoup trop brutal
 - ne s'était pas montré assez féroce
 - s'était conduit comme il l'avait fallu
28. L'amiral avait eu le tort de se tenir, vis-à-vis de l'amiral français,
- bien trop près
 - à une distance convenable
 - beaucoup trop loin
29. De son côté, l'amiral français s'était trouvé
- plus loin de l'amiral anglais que celui-ci ne l'était de lui
 - aussi loin de l'amiral anglais que celui-ci l'était de lui
 - moins loin de l'amiral anglais que celui-ci ne l'était de lui
30. Candide apprit donc qu'en Angleterre on tue quelquefois des amiraux
- pour divertir le public
 - pour donner un bon exemple
 - par philanthropie

V

[*Mme Lechat is talking to her daughter Germaine.*]

MME LECHAT. Qu'est-ce que tu dis? ... (*un petit silence*). ... Oui ... oui ... hausse les épaules. ... (*Un temps*) Et sache que sa fortune ne doit rien à personne ... à personne. ... Est-ce clair? ... Sa fortune ... il l'a gagnée en travaillant. ... Il a eu de la chance ... il a été servi par les événements ... je le veux bien ... mais il a eu encore plus d'adresse et de courage. ... S'il a fait deux fois faillite [bankruptcy] ... n'a-t-il pas obtenu son concordat [legal settlement]? ... S'il a été en prison. ... Hé bien ... quoi? ... ne l'a-t-on pas acquitté? ... Ah! il a eu de rudes moments, le pauvre garçon. ... D'autres, moins énergiques, se fussent brûlé la cervelle. ... Lui, pas. ... A chaque chute, il s'est relevé pour gagner davantage ... et atteindre plus haut. ... Il a fondé un grand journal ... lui qui savait à peine écrire. ... Enfin ... voyons ... si ton père était une canaille [rascal] ... est-ce qu'il serait l'ami d'un ministre? ...

GERMAINE (*ironiquement*). De deux ministres ...

31. Mme Lechat
- A. blâme vivement son mari
 - B. ne veut pas entendre parler de son mari
 - C. essaye de justifier son mari
32. M. Lechat, d'après ce que dit sa femme,
- A. a amassé sa fortune lui-même, par ses propres efforts
 - B. a toujours manqué d'habileté et de fermeté d'esprit
 - C. n'a guère su profiter des événements
33. M. Lechat
- A. n'avait jamais su ce que c'est que la banqueroute
 - B. a su s'arranger avec ceux à qui il devait de l'argent
 - C. a payé toutes ses dettes jusqu'au dernier sou
34. Le père de Germaine
- A. n'est entré en prison que pour en sortir
 - B. a été condamné à de lourdes peines
 - C. s'est échappé de prison avec beaucoup d'adresse
35. Ce qui, dans le caractère de M. Lechat, frappe surtout sa femme, c'est
- A. son manque d'énergie
 - B. sa forte volonté
 - C. son extrême douceur
36. M. Lechat fonda un grand journal
- A. bien qu'il sût à peine écrire
 - B. parce qu'il savait à peine écrire
 - C. parce qu'il aimait les articles bien écrits
37. M. Lechat connaît deux ministres; or Mme Lechat croit
- A. que les amis des ministres sont d'assez tristes personnages
 - B. que l'ami d'un ministre est nécessairement un honnête homme
 - C. qu'aucun ami d'un ministre n'a jamais été en prison

VI

Lorsque, dans la même personne ou dans le même corps de magistrature, la puissance législative est réunie à la puissance exécutive, il n'y a point de liberté, parce qu'on peut craindre que le même monarque ou le même sénat ne fasse des lois tyranniques pour les exécuter tyranniquement.

Il n'y a point encore de liberté, si la puissance de juger n'est pas séparée de la puissance législative et de l'exécutive. Si elle était jointe à la puissance législative, le pouvoir sur la vie et la liberté des citoyens serait arbitraire; car le juge serait législateur. Si elle était jointe à la puissance exécutive, le juge pourrait avoir la force d'un oppresseur.

Tout serait perdu, si le même homme, ou le même corps des principaux, ou des nobles, ou du peuple, exerçait ce trois pouvoirs: celui de faire des lois, celui d'exécuter les résolutions publiques, et celui de juger les crimes ou les différends des particuliers.

38. L'auteur de ce passage

- A. ne veut point séparer de la puissance exécutive la puissance législative
- B. s'oppose à l'union des puissances législative et exécutive
- C. trouve qu'il n'y a point de liberté à moins que les puissances législative et exécutive ne soient réunies

39. Cet écrivain

- A. croit que la liberté n'existe point là où celui qui juge ne peut pas mettre en vigueur ses décisions
- B. recommande que le juge puisse opprimer les coupables
- C. s'oppose à l'union de la puissance de juger et de l'une des deux autres puissances

40. Celui qui a écrit ce passage

- A. veut que le peuple exerce lui-même ces trois pouvoirs
- B. tient à ce qu'un seul homme ne soit pas chargé de trop d'autorité
- C. insiste pour qu'un seul homme remplisse ces trois fonctions

41. Cet auteur

- A. veut un gouvernement responsable et sage
- B. est un précurseur du fascisme
- C. expose avec beaucoup d'éloquence les doctrines anarchistes

VII

Instruite de ce qui venait d'avoir lieu, soit par la rumeur qui se répandit, soit par l'assassin lui-même, Frédégonde avait envie de voir son ennemi agonisant. Elle se rendit à la maison de l'évêque, accompagnée des duc Auswald et Beppolon, qui ignoraient tous deux la part qu'elle avait prise à ce crime et l'étrange entretien dont ils allaient être témoins. Praetextatus, étendu sur son lit, bien que la mort fût tout près, était encore sensible à ce qui se passait autour de lui. La reine orgueilleuse se garda de montrer sa joie; elle se tordit [wring] les mains en s'écriant: «Quel sort amer pour nous tous qu'un pareil mal soit arrivé à ta personne vénérable! Plût à Dieu de nous désigner le fou qui a osé commettre ce crime inouï afin qu'il subit un tourment affreux!»

Le vieillard, dont les soupçons étaient confirmés par cette visite même, se souleva et s'écria: «Et qui a frappé ce coup si ce n'est pas la main maudite [cursed] qui a si souvent répandu le sang et fait tant de maux dans le royaume?» Aucun signe de trouble ne se trahissait sur le visage de la reine. Elle reprit du ton le plus calme: «Sachez qu'il y a de très habiles médecins qui sont capables de guérir cette blessure. Veuillez bien, ô saint évêque, les envoyer chercher.» Dans un élan de colère qui épuisa le reste de ses forces, l'homme abattu répondit: «Je sens que Dieu veut me rappeler de ce monde; mais toi qui as conçu cette atteinte qui m'ôte la vie, tu seras haïe dans tous les siècles, et la justice divine ne tardera pas à t'écraser dans la boue [mud]!» Frédégonde se tut, les lèvres serrées, et Praetextatus rendit le dernier soupir.

42. A la nouvelle de ce crime, la reine Frédégonde fut

- A. étonnée
- B. accablée
- C. contente

43. Etant allé voir l'évêque, la reine

- A. le plaignit sincèrement
- B. goûta son triomphe
- C. eut des remords

44. Praetextatus

- A. ne soupçonna pas le véritable auteur du crime
- B. ne se tenait pas de joie en voyant entrer la reine
- C. se doutait bien de l'identité du vrai coupable

45. La reine

- A. demanda la bénédiction du saint évêque
- B. fit semblant d'espérer la guérison de la victime
- C. dit des insultes à Praetextatus

46. L'évêque Praetextatus

- A. remercia sa souveraine
- B. loua les vertus de la reine
- C. maudit la reine Frédégonde

47. La reine Frédégonde

- A. n'était pas d'une bonté exceptionnelle
- B. était d'une nature très douce
- C. se laissa émouvoir par les paroles de l'évêque



THE UNITED STATES ARMED FORCES INSTITUTE

Examination in ITALIAN READING COMPREHENSION—Lower Level

Form LIR-I-B-4

DIRECTIONS: You have 50 minutes for this examination. As you answer the questions, you should omit any that seem unusually difficult until you finish the others.

Your answers to the exercises in this examination are to be recorded on the separate ANSWER SHEET which is loosely inserted in this examination booklet. **Remove this answer sheet now;** write your name and the other information called for in the blanks at the top of the answer sheet; then finish reading these directions.

After the number on the answer sheet corresponding to that of each exercise, mark the **one** lettered space which designates the answer you have selected as correct. If your answer sheet contains rows of squares, indicate each answer with a cross (X), for example,

A	B	C	D	E
X				

If your answer sheet contains rows of paired dotted lines, indicate each answer with a **heavy black mark** with the special pencil, for example,

A	B	C	D	E
█	⋮	⋮	⋮	⋮

Avoid resting the point of your pencil on the answer sheet while you are considering your answer. Do not make unnecessary marks. If you change an answer, erase your first mark completely. Do not fold or crease your answer sheet.

EXAMPLES

L'originalità del Machiavelli è non meno morale che politica: anzi, poichè a fondamento della sua politica sta una morale nuova, diremo che in ultima analisi la sua originalità maggiore è di carattere morale. Se egli può ancora oggi essere ammirato e studiato dagli uomini politici, l'attrazione maggiore che egli esercita sui comuni lettori dipende dalla sua speculazione morale, dalla sicurezza con cui egli descrive i tratti della nostra coscienza, dallo sguardo antisentimentale con cui egli constata la semplicità, la debolezza, la miseria degli uomini.

0. L'originalità del Machiavelli è

- A. meno morale che politica.
- B. più politica che morale.
- C. più morale che politica.

[The correct answer is **più morale che politica**; therefore, answer space C would be marked on the answer sheet.]

00. Il Machiavelli

- A. sapeva osservare gli uomini.
- B. non poteva esprimersi chiaramente.
- C. si perdeva nelle speculazioni idealistiche.

[The correct answer is **sapeva osservare gli uomini**; therefore, answer space A would be marked on the answer sheet.]

Prepared by the

EXAMINATIONS STAFF FOR THE UNITED STATES ARMED FORCES INSTITUTE

Published by

THE AMERICAN COUNCIL ON EDUCATION

Distributed by

The Cooperative Test Service of
THE AMERICAN COUNCIL ON EDUCATION
15 Amsterdam Avenue, New York 23, N. Y.

SCIENCE RESEARCH ASSOCIATES
228 South Wabash Avenue, Chicago 4, Ill.

Copyright, 1945

THE AMERICAN COUNCIL ON EDUCATION

MARE

M'affaccio alla finestra, e vedo il mare:
vanno le stelle, tremolano l'onde.
Vedo stelle passare, onde passare:
un guizzo [vibration] chiama, un palpito risponde.

Ecco sospira l'acqua, alita il vento:
sul mare è apparso un bel ponte d'argento.

Ponte gettato sui laghi sereni,
per chi dunque sei fatto e dove meni?

- | | |
|---|--|
| <p>1. Il poeta</p> <ul style="list-style-type: none">A. chiude la finestra.B. si mette alla finestra.C. salta dalla finestra. <p>2. Si vede questa sera</p> <ul style="list-style-type: none">A. una bella natura in un riposo profondo.B. una profonda caduta di neve.C. una tempesta violenta sul mare. <p>3. Il poeta vede</p> <ul style="list-style-type: none">A. il sole quasi nascosto dalle nuvole.B. gli astri e la riflessione della luna sull'acqua.C. qualche punto luminoso attraverso una nebbia folta. | <p>4. Guardando questo spettacolo, egli sente</p> <ul style="list-style-type: none">A. la calma e la pace.B. niente affatto.C. un terrore cieco. <p>5. Questa poesia</p> <ul style="list-style-type: none">A. è una satira crudele contro la religione.B. narra un grand'avvenimento storico.C. ricorda impressioni d'una tranquillità bella e profonda. |
|---|--|

Una paesana rimproverando un suo bambino, lo minacciò, se non tacesse, che lo darebbe a mangiare a un lupo. Ora un lupo che a caso passava per là, udendo dir questo alla donna credette che dicesse vero, e, messosi innanzi all'uscio di casa, così stette quivi tutto quel giorno ad aspettare che la donna gli portasse quella vivanda. Vi stette tutto quel tempo, ma la donna non se n'accorgeva e non n'aveva paura e non gli faceva segno con sasso o altra cosa. Onde il lupo non ebbe niente, perchè il fanciullo s'addormentò, e, quando bene non l'avesse fatto, non ci sarebbe stato pericolo. E fatto tardi, tornato alla moglie senza preda perchè s'era tardato ad aspettare fino a sera, disse che una parola di donna non valeva un fico, e chi farebbe la sciocchezza di crederci una seconda volta meriterebbe di morire di fame.

6. La paesana

- A. ebbe pietà del povero lupo.
- B. non amava affatto il suo fanciullo.
- C. volle far paura al suo bambino.

7. Il lupo

- A. aspettò tranquillamente molte ore.
- B. entrò nella casa.
- C. ringraziò con calore la paesana.

8. La paesana

- A. colpì con furia il suo bambino.
- B. non teneva sempre le sue promesse.
- C. si addormentò.

9. Il lupo

- A. cominciò a mangiare con un forte chiasso.
- B. credette ciò che aveva detto la paesana.
- C. cullò con tenerezza il bambino.

10. Il lupo

- A. dovè mostrarsi molto paziente.
- B. gettò grandi sassi contro la casa.
- C. rise come se fosse pazzo.

11. La paesana

- A. diede al lupo la vivanda promessa.
- B. fece segno parecchie volte allo stupido lupo.
- C. non pensò affatto al lupo.

12. Il bambino

- A. cessò di urlare.
- B. non poteva addormentarsi.
- C. stava sempre in gran pericolo.

13. Dopo questa sventura, il lupo

- A. non volle più mangiare carne.
- B. perdette un'illusione.
- C. si innamorò della paesana.

ROSAURA. Crudele! E voi avete cuore d'abbandonarmi?
OTTAVIO. Ah, Rosaura, non accrescite colle vostre lacrime il mio dolore. Pur troppo sento spezzarmi il cuore nel distaccarmi da voi; ma convien farlo, non vi è rimedio.
ROSAURA. Come non vi è rimedio? E chi può violentare gli affetti nostri?
OTTAVIO. L'autorità di vostro padre.
ROSAURA. Egli più non vive.
OTTAVIO. Sì, ma estinto ancora sa farsi obbedire col rigoroso suo testamento.
ROSAURA. Il suo testamento non può dispor del mio cuore.
OTTAVIO. Ma dispone della vostra fortuna.
ROSAURA. La mia fortuna consiste nell'amor vostro.
OTTAVIO. Rosaura, vi pentirete d'aver sacrificato per me una eredità sì preziosa.
ROSAURA. V'ingannate; non conoscete il mio cuore. Fate torto alla tenerezza dell'amor mio. Rinunzierei, o caro, per voi, anco un regno.
OTTAVIO. Sarei indegno del vostro affetto, se non sapessi consigliarvi ad amar meglio voi stessa.
ROSAURA. Ah, dite piuttosto che disprezzate il mio cuore, che non vi curate della mia mano.

14. Rosaura
- A. è contenta che Ottavio se ne vada.
 - B. insiste per che Ottavio se ne vada.
 - C. non vuole che Ottavio parta.
15. Ottavio
- A. giura di non abbandonare mai Rosaura.
 - B. rinunzia alla mano di Rosaura.
 - C. ubbidisce alla volontà di Rosaura.
16. Il padre di Rosaura
- A. è morto.
 - B. non ha fatto il suo testamento.
 - C. non ha mai saputo farsi ubbidire dalla figlia.
17. Rosaura crede che
- A. il testamento importi più che l'amore.
 - B. l'amore non abbia a che fare coi testamenti.
 - C. una figlia dovrebbe ubbidire sempre al padre.
18. Il testamento dispone
- A. dell'amore ma non della fortuna di Rosaura.
 - B. della fortuna ma non dell'amore di Rosaura.
 - C. nè della fortuna nè dell'amore di Rosaura.
19. Secondo Rosaura, la sua fortuna
- A. è l'amore d'Ottavio.
 - B. è più importante dell'amore d'Ottavio.
 - C. non consiste nell'amore d'Ottavio.
20. Ottavio
- A. non ha cura se Rosaura perdesse la fortuna del padre.
 - B. teme che Rosaura non si penta più tardi di aver perduta la fortuna del padre.
 - C. vuole che Rosaura perda la fortuna del padre.
21. Rosaura
- A. non rinunzierebbe nè alla fortuna nè all'amore.
 - B. rinunzierebbe all'amore ma non alla fortuna.
 - C. rinunzierebbe volentieri alla fortuna ma non all'amore.
22. I consigli d'Ottavio sono quelli
- A. d'un amante appassionato.
 - B. d'un uomo pazzo.
 - C. d'un uomo prudente.

Per il Machiavelli le due leve che sollevano il mondo sono la fortuna e la "virtù," intesa nel senso di prontezza e forza di agire. L'una senza l'altra non giova: nemmeno la prima senza la seconda, perchè senza la virtù l'occasione viene invano (*Principe*, cap. VI). Ed è la virtù quella che fa l'uomo. Il Machiavelli concepisce la vita come azione, come lotta: e per questo è nemico del cristianesimo, perchè gli pare che abitui troppo alla rassegnazione e indebolisca la tempra. Egli ha il senso di quanto sia difficile la vita; sa che tutto si acquista con difficoltà e tutto si conserva con difficoltà: e perciò la maggior lezione che egli dà al suo principe è quella di star vigile sempre, per afferrar la fortuna o per non lasciare che essa lo abbandoni. La fortuna stessa nella mente del Machiavelli diventa maestra di lotta: "E però la fortuna, massime quando vuole fare grande un principe nuovo, il quale ha maggiore necessità di acquistare reputazione che uno ereditario, gli fa nascere de' nemici, e gli fa fare delle imprese contro, acciò che quello abbia cagione di superarle."

23. Dove si trova la fortuna,

- A. la virtù importa assai.
- B. la virtù non vi può essere.
- C. non c'è bisogno della virtù.

24. La "virtù" vuol dire

- A. fede ed umiltà.
- B. fortuna e felicità.
- C. attività ed energia.

25. Secondo il Machiavelli, la vita è

- A. una battaglia senza fine.
- B. una burla enorme.
- C. una ricerca della voluttà.

26. Gli pare che la religione sia

- A. la fonte di tutte le buone cose.
- B. nemica dell'energia.
- C. una cosa che non esiste.

27. Il Machiavelli crede che

- A. niente si perda senza difficoltà.
- B. nulla si possa avere senza difficoltà.
- C. tutto si perda con difficoltà.

28. Il principe dovrebbe dunque

- A. fidarsi della fortuna.
- B. godere la vita senza troppe cure.
- C. non essere mai negligente.

29. La fortuna

- A. è sempre nemica dei principi nuovi.
- B. non abbandona mai un principe nuovo.
- C. suscita qualche volta nemici contro un principe nuovo affinché egli possa vincerli.

30. Si vede in quel passaggio che il Machiavelli

- A. crede in Dio.
- B. crede nella fortuna.
- C. non crede niente.

Federico II (1212-50) era nato a Iesi nel dicembre 1194; aveva dunque diciotto anni appena quando fu incoronato re di Germania.

D'ingegno pronto, di mente aperta, educato accuratamente, Federico II aveva della cultura e della vita una concezione più ampia e libera di quella che ne avevano i contemporanei, onde il suo interesse alle osservazioni e alle esperienze naturali, la sua attitudine tollerante e benevola verso il mondo islamico, attitudine connessa ad una certa tendenza allo scetticismo con qualche venatura d'incredulità, ed una maggiore libertà di costumi che il Medio Evo, almeno teoricamente, potesse comportare.

A queste tendenze non eccessivamente ortodosse Federico univa una concezione politica assolutistica, in contrasto con i diritti dei feudatari, con le libertà dei Comuni, coi privilegi della Chiesa e con l'autorità che questa si attribuiva di suprema direttrice della intera vita della cristianità.

Nato e cresciuto in Italia, Federico vi rimase per la maggior parte della sua vita, considerando il regno di Sicilia centro del suo dominio. Si occupò quindi assai poco di cose di Germania; capiva anche malamente il tedesco. Per non avere molestie dai grandi tedeschi, li favorì assai, specialmente gli ecclesiastici, di privilegi, e di diritti di governo, così da renderli quasi indipendenti dal potere reale e da sanzionare la formazione della sovranità territoriale (nella dieta di Cividale del 1232), e cercò di ristabilire il loro potere sulle città annullando i privilegi di queste.

31. Federico II

- A. fu fatto re quando era ancora giovane.
- B. fu incoronato nel 1194.
- C. nacque nel 1212.

32. Il giovane principe

- A. aveva in tutto opinioni eccessivamente ortodosse.
- B. non capiva rapidamente le cose.
- C. ricevè una buon' educazione.

33. Questo re

- A. aveva, sulle questioni non politiche, idee assai larghe.
- B. non si interessava affatto ai problemi scientifici.
- C. rimproverava la libertà di costumi dei suoi contemporanei.

34. Il re

- A. aveva in odio lo scetticismo.
- B. credeva ciecamente a tutto ciò che si credeva nel Medio Evo.
- C. non perseguitava l'islamismo.

35. La Chiesa

- A. aiutava in ogni modo Federico II.
- B. non si mescolava mai nella politica.
- C. pretendeva far valere su ogni cristiano un' autorità assoluta.

36. Federico II

- A. andava spesso in Germania.
- B. favoriva poco gli ecclesiastici della Germania.
- C. si occupava più delle cose italiane che di quelle tedesche.

37. Federico II

- A. cercava di annullare il potere dei nobili tedeschi.
- B. non accrebbe i privilegi delle città.
- C. parlava bene tedesco.

Il vivere libero è assai più bello del vivere in carcere; chi ne dubita? Eppure anche nelle miserie d'un carcere, quando ivi si pensa che Dio è presente, che le gioie del mondo sono fugaci, che il vero bene sta nella coscienza e non negli oggetti esteriori, puossi con piacere sentire la vita. Io in meno d'un mese avevo pigliato, non dirò perfettamente, ma in comportevole guisa, il mio partito. Vidi che non volendo commettere l'indegna azione di comprare l'impunità col procacciare la rovina altrui, la mia sorte non poteva essere se non il patibolo [scaffold] od una lunga prigionia. Era necessità adattarvisi... Respirerò finchè mi lasciano fiato, dissi, e quando me lo torranno, farò come tutti i malati, allorchè son giunti all'ultimo momento: morirò.

38. Nel tempo del quale si tratta, l'autore

- A. dubitava se il vivere fosse bello.
- B. era incarcerato.
- C. era libero.

39. L'autore crede che

- A. Dio è fuori del carcere.
- B. i veri beni dell'esistenza non sono materiali.
- C. le gioie del mondo sono nella coscienza.

40. Colui che è veramente sapiente

- A. morrà di noia in meno d'un mese di carcere.
- B. non sarà troppo triste nel carcere.
- C. non troverà il piacere fuori del carcere.

41. L'autore

- A. desiderava morire.
- B. non consentì a comprare la sua libertà con la rovina altrui.
- C. volle liberarsi rovinando altrui.

42. Si vede dunque che l'autore

- A. doveva morire in carcere.
- B. non perse il suo coraggio.
- C. si curava poco della libertà.



THE UNITED STATES ARMED FORCES INSTITUTE

Examination in **SPANISH READING COMPREHENSION—Lower Level**
Form LSR-I-B-4

DIRECTIONS: You have 50 minutes for this test. As you answer the questions, you should omit any that seem unusually difficult until you finish the others.

Your answers to the exercises in this test are to be recorded on the separate ANSWER SHEET which is loosely inserted in the test booklet. **Remove this answer sheet now;** write your name and the other information called for in the blanks at the top of the answer sheet; then finish reading these directions.

After the number on the answer sheet corresponding to that of each exercise, mark the **one** lettered space which designates the answer you have selected as correct. If your answer sheet contains rows of squares, indicate each answer with a cross (X), for example,

A	B	C	D	E
<input type="checkbox"/>	<input checked="" type="checkbox"/>	<input type="checkbox"/>	<input type="checkbox"/>	<input type="checkbox"/>

If your answer sheet contains rows of paired dotted lines, indicate each answer with a **heavy black mark** with the special pencil, for example,

A	B	C	D	E

Avoid resting the point of your pencil on the answer sheet while you are considering your answer. Do not make unnecessary marks. If you change an answer, erase your first mark completely. Do not fold or crease your answer sheet.

EXAMPLES

Una nación no se impone sólo con fuerzas militares y navales: necesita tener ideas flexibles y que se presten a una rápida difusión; y estas ideas no hay medio de inventarlas: nacen, como vemos constantemente en Francia, de la fusión de las ideas tomadas del extranjero con las ideas nacionales. Hay que sacrificar la espontaneidad del pensamiento propio; hay que fraguar (forge) "ideas generales" que tengan curso en todos los países, para aspirar a una influencia política durable.

0. Según este autor, la influencia de una nación

- A. depende de su habilidad de conquistar a las otras naciones en la guerra
- B. no depende de sus armas exclusivamente sino también de sus ideas
- C. sólo depende de su filosofía política

[The correct answer is **no depende de sus armas exclusivamente sino también de sus ideas**; therefore, answer space B would be marked on the answer sheet.]

00. Según él, estas ideas

- A. se encuentran en el propio país, libres de influencia extranjera
- B. tienen que ser formadas por los políticos de la nación
- C. brotan de una combinación de las ideas de la nación con las de otras naciones

[The correct answer is **brotan de una combinación de las ideas de la nación con las de otras naciones**; therefore, answer space C would be marked on the answer sheet.]

Prepared by the
EXAMINATIONS STAFF FOR THE UNITED STATES ARMED FORCES INSTITUTE

Published by
THE AMERICAN COUNCIL ON EDUCATION

Distributed by
THE AMERICAN COUNCIL ON EDUCATION
15 Amsterdam Avenue, New York 23

SCIENCE RESEARCH ASSOCIATES
228 South Wabash Avenue, Chicago 4

Copyright, 1944

THE AMERICAN COUNCIL ON EDUCATION

ORDER NO. 723

[Al levantarse el telón están en escena Irene y don Juan. Irene, la secretaria, muchacha de unos veintidós años, simpática, vestida con modestia, lleva sobre un traje sastre sencillo, un delantal de seda negra. Don Juan, caballero de unos cincuenta años, bien vestido, es ligeramente calvo [bald]. La secretaria está sentada a la mesa de la máquina, poniendo en el orden más perfecto notas y papeles. Don Juan pasea mientras habla. No tiene bastón ni sombrero, porque los ha dejado en el vestíbulo.]

DON JUAN.—Mucho tarda en volver nuestro insigne novelista.

IRENE.—(*Ocupada.*) Sí.

DON JUAN.—¿No sabe Vd. dónde ha ido?

IRENE.—(*Ocupada.*) No.

DON JUAN.—Generalmente, no acostumbra a salir por la mañana, ¿verdad?

IRENE.—(*Ocupada.*) No. (*Sin mirarle.*) Si quiere Vd. dejarle algún recado [message]

DON JUAN.—Prefiero esperarle todavía un momento, si a Vd. no la molesta.

IRENE.—Nada absolutamente.

DON JUAN.—(*Que es de las personas que no pueden estarse calladas, aunque supongan que estorban hablando.*)
¿Está Vd. trabajando?

IRENE.—No. (*Como ha terminado de arreglar los papeles, se levanta y se quita el delantal, que dobla cuidadosamente.*)
Se acabó el trabajo.

DON JUAN.—¿Por hoy?

IRENE.—Por hoy y para siempre. Esta es mi última hora de secretaría “oficial.”

- | | |
|--|---|
| <p>1. La secretaria es</p> <ul style="list-style-type: none">A. una linda muchacha en busca de trabajoB. una mujer fea y desagradableC. una joven muy simpática <p>2. Irene está vestida</p> <ul style="list-style-type: none">A. con mucho lujoB. práctica y sencillamenteC. con mal gusto <p>3. Mientras hablan, Don Juan</p> <ul style="list-style-type: none">A. está sentado a la mesa trabajandoB. está mirando por la ventana tranquilamenteC. está dando vueltas por el cuarto nerviosamente | <p>4. Irene</p> <ul style="list-style-type: none">A. está escribiendo unas cartasB. está paseando por el cuartoC. está arreglando su mesa de trabajo <p>5. Don Juan</p> <ul style="list-style-type: none">A. quiere esperar hasta que vuelva el novelistaB. no puede esperar hasta que llegue el novelistaC. quiere dejar un recado para el novelista <p>6. Irene está terminando su trabajo</p> <ul style="list-style-type: none">A. por el díaB. por la semanaC. para siempre |
|--|---|

II

En efecto, una noche los indios al mando del nuevo cacique [chieftain] atacaron la fortaleza de los blancos. Yamandú se robó a doña Blanca y se internó con ella en el bosque. Ella lanzó un grito horroroso y ese grito resonó en el corazón de otro indio que por allí vagaba errante y triste, y que apareció de repente.

Era Tabaré, un indio que amaba a doña Blanca. Este saltó sobre el cacique, luchó con él y le mató, librando a su amada. Entonces escondió el cadáver en unas zarzas [brambles]. Oyendo el llanto de la doncella que estaba volviendo en sí, volvió al sitio en que la había dejado. Cuando la española miró a Tabaré, le acusó de haberla robado, pues durante su desmayo no se había dado cuenta de la escena entre los dos indios.

7. Durante el conflicto

- A. el jefe indio llevó cautiva a una mujer
- B. los salvajes mataron a toda la colonia
- C. los españoles echaron a los indios hacia el bosque

8. El robo de doña Blanca dió por resultado

- A. la más completa felicidad entre los indios
- B. una lucha entre los indios y los españoles
- C. la muerte del cacique indio

9. Tabaré mató a Yamandú porque

- A. quería salvar a la española
- B. iba en busca del jefe con el propósito de matarle
- C. el cacique le atacó en el bosque

10. Doña Blanca no se dió cuenta de su salvación porque

- A. veía que Tabaré había matado a Yamandú con la intención de robársela
- B. se había desmayado antes de la lucha y no sabía nada de ella
- C. no quería salvarse

III

¿Qué acontecimiento registra la historia del mundo, superior en magnitud y trascendencia al descubrimiento [discovery] de América? ¿Qué otro suceso podrá en lo porvenir ser superior al realizado el 12 de octubre de 1492, dando al hombre la comprensión integral de su morada [abode] terrestre? Como suceso magno, el descubrimiento de América sólo tendrá comparación posible cuando al genio del hombre le sea asequible [within reach] una de esas constelaciones que lucen en el cielo infinito. Y el mismo efecto que produciría en la Humanidad el conocimiento y posesión del astro habitable, la llegada del hombre a la estrella remotísima, produjo en su día la llegada de los marineros de Colón al nuevo Continente. La posibilidad de morar, vivir y lograr opulencia en una estrella daría lugar a transformar los valores, a trastornar, digamos así, los centros esenciales del mundo por medio del incalculables procesos de movimiento social. Pues esto mismo ocurrió al descubrirse América. El Mediterráneo, el mar latino, viejo centro de la civilización y foco absorbente de las actividades económicas, del comercio de la vida universal, perdió su preponderancia al dilatarse los horizontes de la tierra.

11. Según este autor, el descubrimiento de América

- A. no significa tanto como dicen los españoles
- B. ocurrió de acuerdo con la providencia de Dios
- C. ocupa el lugar más alto en la historia humana

12. El dice que

- A. el descubrimiento del nuevo mundo bien puede compararse con la creación del universo
- B. el descubrimiento de América hizo posible la llegada del hombre a las estrellas
- C. el descubrimiento de América tuvo el mismo resultado que tendría la llegada del hombre a un astro

13. El autor dice aquí

- A. que lo que hizo Colón era de suma importancia para los españoles
- B. que el descubrimiento de América tenía significado limitado y local
- C. que el descubrimiento del nuevo mundo tenía influencia en toda la civilización humana

14. El descubrimiento de América

- A. causó un cambio radical en la vida social del mundo
- B. dió nuevo ímpetu al estudio de la astronomía
- C. comprobó las nuevas teorías de Cristóbal Colón

15. Después del descubrimiento de América

- A. el Mediterráneo se convirtió en el centro de la civilización
- B. el Mediterráneo no llevaba la misma importancia central en la vida del hombre como antes
- C. el Mediterráneo perdió toda su importancia en la vida civilizada

16. El descubrimiento de América

- A. puso fin a las actividades económicas de España
- B. dió al hombre conocimiento de horizontes más amplios
- C. no tenía mucho resultado en el comercio del mundo

IV

Don Plácido era un hombre de unos cuarenta y cinco años; bajo, muy gordo, coloradísimo, pero no antipático; sus ademanes eran presuntuosos; en todo él se adivinaba su dinero. El gran propietario habló de los millones que tenía en haciendas urbanas y los en el Banco de España; afirmó que había resuelto establecerse en Madrid, comprar coches, tener gran mesa, dar magníficos bailes, y, en fin, gastar sus inmensas rentas alegremente. Añadió que pensaba casarse y dirigió a Julia una mirada de triunfador, que, de rechazo, se entró en mi pecho como una flecha. Noté que la madre y la tía de Julia hablaban mucho con don Plácido; la madre expresaba sorpresa y placer a la vez. Creí notar que me dirigía miradas de piedad.

17. Don Plácido era

- A. un hombre de apariencia muy atractiva
- B. un hombre humilde y generoso
- C. un hombre simpático, aunque de apariencia poco atractiva

18. Dió la impresión de

- A. un trabajador que vivía de su labor
- B. un rico muy interesado en su dinero
- C. un hombre que no tenía interés en el dinero

19. Había decidido

- A. vivir en la ciudad
- B. comprar la propiedad de la madre de Julia
- C. salir de Madrid cuanto antes

20. Aparentemente don Plácido

- A. tenía una familia bastante grande
- B. esperaba a su esposa
- C. buscaba una esposa

21. Tenía ganas de casarse con

- A. Julia
- B. la madre de Julia
- C. la tía de Julia

22. Su interés por la muchacha

- A. no le preocupó al narrador
- B. causó mucha pena al narrador
- C. fué muy grato al narrador

v

Muy cerca de mi ocaso [decline], yo te bendigo, Vida,
porque nunca me diste ni esperanza fallida [false]
ni trabajos injustos, ni pena inmerecida;
porque veo al final de mi rudo camino
que yo fuí arquitecto de mi propio destino;
que si extraje las mieles o la hiel [gall] de las cosas,
fué porque en ellas puse hiel o mieles sabrosas:
cuando planté rosales, coseché siempre rosas.

. . . . Cierto, a mis lozanías [vigorous manhood] va a seguir el invierno:
¡mas tú no me dijiste que Mayo fuese eterno!

Hallé sin duda largas las noches de mis penas;
mas no me prometiste tú sólo noches buenas;
y en cambio tuve algunas santamente serenas. . . .

Amé, fuí amado, el sol acarició mi faz.
¡Vida, nada me debes! ¡Vida, estamos en paz!

23. El poeta es
- A. un niño sin experiencia de la vida
 - B. un hombre viejo que ha pasado por las experiencias de la vida
 - C. un joven que espera las experiencias del futuro
24. Bendice a la Vida
- A. porque le ha tratado bien
 - B. porque está llegando al final de su camino
 - C. porque le ha sido injusta y mala
25. El poeta dice
- A. que él ha sido la víctima de fuerzas ciegas
 - B. que él no tiene la culpa de las desgracias que ha sufrido
 - C. que él mismo lleva la responsabilidad de todo lo que le ha acontecido
26. El poeta habla
- A. de la relación directa entre lo que él ha hecho y lo que le ha ocurrido
 - B. de su amor por la vida del campo
 - C. de su precioso jardín de flores
27. El poeta sigue
- A. hablando de las diferencias entre las estaciones del año
 - B. expresando la opinión de que la llegada de la vejez es cosa esperada y natural
 - C. quejándose de la vanidad de la vida
28. El autor expresa su gratitud
- A. porque nunca ha tenido experiencias malas en su vida
 - B. porque no sólo ha tenido malas experiencias, sino buenas también
 - C. porque se siente tan joven a pesar de sus muchos años
29. El poeta está persuadido de que
- A. debe cobrar más felicidad de la Vida
 - B. la Vida le ha robado y maltratado
 - C. él no debe quejarse de lo que la Vida le ha dado

VI

Esta señorita yanqui había formado ya, en el breve lapso de una semana, su opinión acerca de España, que comenzó, desde luego, a comunicarme sin que yo la solicitase. Muchas cosas de España le causaban sorpresa, claro está. Procuré disculpar nuestras cosas diciendo: "En España se concede mucha importancia a lo que en otros países no se le concede ninguna, y vice versa; es cuestión de temperamento y de personalidad." "Cierto—dijo ella—que en España no se concede importancia a lo práctico." Yo dije: "En España sí se concede importancia a lo práctico; lo que sucede es que los españoles tienen un concepto original de lo práctico. ¿Qué le parece a usted el pavimento de Madrid?" Ella respondió: "Infernal." Continué: "¿Y el cielo de Madrid?" "¡Divino!"—exclamó. "Es que los españoles—declaré—prestan más atención al cielo que al suelo."

30. La señorita formó su opinión
- A. después de haber pasado mucho tiempo en España
 - B. sin haber estado en España
 - C. después de muy poco tiempo en España
31. Expresó su opinión al autor
- A. sin que él se la preguntase
 - B. aunque él no quería oírla
 - C. porque él había demostrado su curiosidad sobre el asunto
32. Ella encontró muchas cosas de España
- A. de muy poco interés para un extranjero
 - B. muy razonables desde el punto de vista de un extranjero
 - C. bastante raras para un extranjero
33. El autor defiende su país diciendo que
- A. los españoles tienen la misma actitud hacia la vida que otra gente
 - B. los españoles tienen su propio punto de vista
 - C. nadie puede entender a los españoles
34. Ella opina que en España
- A. hay gran falta de interés en lo material
 - B. se da demasiada importancia a lo material
 - C. no hay sentido común
35. El autor
- A. acepta su crítica sin decir una palabra
 - B. se enoja y termina la conversación
 - C. contesta su crítica hábilmente
36. El autor dice que
- A. la raza española es superior a las demás
 - B. los españoles no tienen interés en lo material
 - C. los españoles tienen más interés en lo espiritual que en lo material

VII

Antiquísimo dicen que es el origen de la moneda, del vil dinero, ni más antiguo ni más vil que otra cualquiera cosa humana. Los salvajes, según se cuenta, se sirven para sus cambios y trueques [barterings] de plumas y conchas [shells], de otros mil objetos, y nosotros, los niños nos servíamos en el colegio de los "santos" o "figuras"—en otras partes se llaman "vistas"—o sea de los cromos de las cajas de fósforos. Porque en cuanto a los sellos de las naciones todas, que también coleccionábamos, éstos eran al modo de lo que son los diamantes y piedras preciosas, no sustancia amonedable y de cambio, sino más bien de lujo y en el fondo una manera de atesorar riqueza disponible, algo que llegada ocasión de apremio [pressure] se puede vender o empeñar.

37. El autor dice aquí que
- A. el dinero es la cosa más vieja y más vil que existe
 - B. la moneda es una moderna invención de los hombres
 - C. el dinero no debe despreciarse más que otras cosas
38. Se usaban los cromos de las cajas de fósforos
- A. como un medio de cambio
 - B. para adornar la sala de clase
 - C. en los estudios primarios
39. Los sellos que también coleccionaban los estudiantes
- A. les enseñaban la geografía
 - B. tenían más valor que los cromos
 - C. venían en las cajas de fósforos
40. De acuerdo con estas costumbres, el niño más rico sería
- A. el que tuviera muchas pesetas
 - B. el que tuviera más plumas y conchas
 - C. el que hubiera coleccionado muchos cromos y sellos



THE UNITED STATES ARMED FORCES INSTITUTE
Examination in GERMAN READING COMPREHENSION—Lower Level
Form LGR-I-B-4

Directions: You have 50 minutes for this test. As you answer the questions you should omit any that seem unusually difficult until you finish the others.

Your answers to the exercises in this test are to be recorded on the separate **answer sheet** which is loosely inserted in the test. **Remove this answer sheet now;** write your name and the other information called for in the blanks at the top of the answer sheet; then finish reading these directions.

After the number on the answer sheet corresponding to that of each exercise, mark the **one** lettered space which designates the answer you have selected as correct. If your answer sheet contains rows of squares, indicate each answer with a cross (X), for example,

A	B	C	D	E
X	□	□	□	□

If your answer sheet contains rows of paired dotted lines, indicate each answer with a **heavy black mark** with the special pencil, for example,

A	B	C	D	E
█	⋮	⋮	⋮	⋮

Avoid resting the point of your pencil on the answer sheet while you are considering your answer. Do not make unnecessary marks. If you change an answer, erase your first mark completely. Do not fold or crease your answer sheet.

EXAMPLES

An einer Theorie ist es nicht ihr geringster Reiz, dass sie widerlegbar ist: gerade damit zieht sie feinere Köpfe an. Es scheint, dass die hundertfach widerlegte Theorie vom "freien Willen" ihre Fortdauer nur noch diesem Reize verdankt —: immer wieder kommt Jemand und fühlt sich stark genug, sie zu widerlegen.

0. Es scheint, dass die Theorie vom "freien Willen" ihre Fortdauer
- A. der Tatsache verdankt, dass sie widerlegbar ist.
 - B. ihrer philosophischen Wichtigkeit verdankt.
 - C. der Tatsache verdankt, dass sich niemand stark genug fühlt, sie zu widerlegen.
 - D. einem Zufall verdankt.

[The correct answer is A; therefore A would be marked on the answer sheet.]

00. Immer wieder kommt jemand und
- A. erklärt den Begriff "freier Wille."
 - B. widerlegt die Theorie, dass es einen "freien Willen" gibt.
 - C. widerlegt die Ansicht, dass es keinen "freien Willen" gibt.
 - D. beweist die Wichtigkeit des Begriffes "freier Wille."

[The correct answer is C; therefore C would be marked on the answer sheet.]

Prepared by the
EXAMINATIONS STAFF FOR THE UNITED STATES ARMED FORCES INSTITUTE

Published by
THE AMERICAN COUNCIL ON EDUCATION

Distributed by

The Cooperative Test Service of THE AMERICAN COUNCIL ON EDUCATION 15 Amsterdam Avenue, New York 23, N. Y.	SCIENCE RESEARCH ASSOCIATES 228 South Wabash Avenue, Chicago 4, Ill.
---	---

Copyright, 1945
 THE AMERICAN COUNCIL ON EDUCATION

I

Noch einmal zogen an diesem Abend die Jünglinge aus den Toren, aber sie dachten diesmal nicht an den Feind, obgleich sie ihm trotz allem nicht trauten und deshalb doch Schild und Schwert mitnahmen. Grüne Zweige holten sie zum Schmuck des Festplatzes, und ungestört brachten sie ganze Wagen voll heim. Die halbe Nacht durch arbeiteten die Schreiner [Schreiner = carpenters] bei Mondlicht; und als die Sonne des ersten Mais aufging, da war der Putz des Marktes der Stadt vollendet und alles bereit zum Fest.

Bier hatte der Rat aus seinem Keller in grossen Fässern herbeifahren lassen; ein Fass edlen Rheinweins gab der Graf von Eberstein, der mit seiner Dame in der Nacht auch noch in das Tor einritt, zum besten. So war alles auf das beste vorbereitet, das Fest nahm seinen Anfang und fröhlichen Verlauf, und nur die Trauernden, die Kranken und die Wächter auf den Mauern nahmen nicht teil daran und erfuhren also auch das bittere Ende nur vom Hörensagen.

1. Diese Geschichte spielt
 - A. in unruhigen oder kriegerischen Zeiten.
 - B. in tiefem Frieden.
 - C. während einer Seuche.
 - D. während eines Erdbebens.
2. Die Geschichte ereignete sich im
 - A. Winter.
 - B. Frühjahr.
 - C. Sommer.
 - D. Herbst.
3. Das Fest endete
 - A. fröhlich.
 - B. traurig.
 - C. in einer Schlacht.
 - D. mit einem Tanz.
4. Die jungen Männer der Stadt holten grüne Zweige. Sie taten das
 - A. am Morgen vor dem Fest.
 - B. am Abend vor dem Fest.
 - C. in der Nacht vor dem Fest.
 - D. am Morgen des Festtages.
5. Der Mann, der den Wein spendete, war
 - A. vor langer Zeit in die Stadt gekommen.
 - B. am Morgen des Festes in die Stadt gekommen.
 - C. nicht selbst in die Stadt gekommen.
 - D. in der Nacht vor dem Fest in die Stadt gekommen.
6. Die Nacht vor dem Feste war
 - A. düster und kalt.
 - B. dunkel und unheimlich.
 - C. vom Monde erleuchtet.
 - D. regnerisch.
7. An dem Feste
 - A. nahm die ganze Bevölkerung ohne Ausnahme teil.
 - B. nahmen alle teil bis auf diejenigen, die durch ernste Gründe daran verhindert waren.
 - C. nahmen die Trauernden, die Kranken, jedoch nicht die Wächter teil.
 - D. nahmen die Trauernden, die Kranken und selbst die Wächter teil.

II

Wie klein ich damals noch gewesen sein muss, sehe ich daran, dass ich auf dem Sessel kniete, um bequem auf den Tisch hinaufzureichen, auf dem ich zeichnete. Es war am Abend, im Winter, in der Stadtwohnung. Der Tisch stand in meinem Zimmer, zwischen den Fenstern, und es war keine Lampe im Zimmer, als die, die auf meine Blätter schien und auf Mademoiselles Buch; denn Mademoiselle sass neben mir, etwas zurückgerückt, und las. Sie war weit weg, wenn sie las; sie konnte lesen, stundenlang, sie blätterte selten um [umblättern = to turn the pages], und ich hatte den Eindruck, als würden die Seiten immer voller, als fügte sie Worte hinzu. Das kam mir so vor, während ich zeichnete. Ich zeichnete langsam, und sah alles, wenn ich nicht weiter wusste, mit ein wenig nach rechts geneigtem Kopfe an; so fiel mir immer am raschesten ein, was noch fehlte. Es waren Offiziere zu Pferd, die in die Schlacht ritten, oder sie waren mitten drin, und das war viel einfacher, weil dann fast nur der Rauch zu machen war, der alles einhüllte. Mutter freilich behauptete immer, dass es Inseln gewesen waren, was ich malte; Inseln mit grossen Bäumen und einem Schloss und einer Treppe und Blumen am Rand.

8. Die hier geschilderte Szene begab sich, als der Held der Geschichte etwa
 - A. ein Jahr alt war.
 - B. sechs Jahre alt war.
 - C. sechzehn Jahre alt war.
 - D. sechzig Jahre alt war.

9. Wenn er entscheiden wollte, was der Zeichnung noch fehle,
 - A. sah er Mademoiselle an.
 - B. wartete er lange.
 - C. neigte er seinen Kopf nach rechts und sah sich die Zeichnung an.
 - D. fügte er Offiziere zu Pferde hinzu.

10. Der Held hatte den Eindruck, dass Mademoiselle
 - A. im Lesen Worte hinzufügte.
 - B. nicht las.
 - C. ihn beim Zeichnen beobachtete.
 - D. schlief.

11. Wir erfahren, dass
 - A. keine Lampe im Zimmer war.
 - B. nur eine Lampe im Zimmer war.
 - C. viele Lampen im Zimmer waren.
 - D. das Licht der Lampe zum Zeichnen ungenügend war.

12. Der Held der Geschichte zeichnete
 - A. Offiziere, die in den Kampf zogen.
 - B. einen Tisch.
 - C. Mademoiselle, ein Buch lesend.
 - D. Offiziere, die aus einer Schlacht nach Hause ritten.

13. In dem Zimmer standen: ein Tisch,
 - A. Sessel und eine Lampe.
 - B. Sessel und keine Lampe.
 - C. der weit weg vom Fenster stand.
 - D. ein Bett, mehrere Stühle und Lampen.

14. Der Autor schildert:
 - A. ein aufregendes Ereignis.
 - B. eine eher alltägliche Szene.
 - C. den Konflikt zwischen den verschiedenen Generationen.
 - D. den Künstler im Kampf mit der Welt.

In einem Winkel seiner Werkstatt las
 Buonarrotti, da es dämmerte;
 Allmählich vor dem Blicke schwand die Schrift . . .
 Da schlich sich Julianus ein, der Träumer,
 Der einzige der heitern Medici,
 Der Schwermut kannte. Dieser glaubte sich [Schwermut = melancholy]
 Allein. Er setzte sich und in der Hand
 Barg er das Kinn und hielt gesenkt das Haupt.
 So sass er schweigend bei den Marmorbildern,
 Die durch das Dunkel leise schimmerten,
 Und kam mit ihnen murmelnd ins Gespräch,
 Geheim belauscht von Michelangelo:
 "Feigheit ist's nicht und stammt von Feigheit nicht,
 Wenn einer seinem Erdenlos misstraut,
 Sich sehnd nach dem letzten Atemzug,
 Denn auch ein Glücklicher weiss nicht, was kommt
 Und völlig unerträglich werden kann—
 Leidlose Steine, wie beneid' ich euch!"
 Er ging und aus dem Leben schwand er dann
 Fast unbemerkt. Nach einem Zeitverlauf
 Bestellten sie bei Michelangelo
 Das Grabbild ihm und brachten emsig her, [emsig = diligently]
 Was noch an Schilderein vorhanden war [Schilderein = pictures]
 Von schwachen Spuren seines Angesichts.
 So waren seine Züge, sagten sie.
 Der Meister schob es mit der Hand zurück:
 "Nehmt weg! Ich sehe, wie er sitzt und sinnt
 Und kenne seine Seele. Das genügt."

15. Eines Tages
 - A. schlich Michelangelo dem Julianus nach.
 - B. erwartete Michelangelo Julianus in seiner Werkstatt.
 - C. kam Julianus unerwarteterweise in Michelangelos Werkstatt.
 - D. traf Michelangelo Julianus in einem Museum.
16. Dies geschah
 - A. zur Mittagszeit.
 - B. an einem regnerischen Tag.
 - C. an einem Abend.
 - D. während der Morgendämmerung.
17. Julianus sprach
 - A. zu Michelangelo.
 - B. zu seinen Freunden.
 - C. zu sich selbst.
 - D. zu den Statuen.
18. Michelangelo
 - A. unterbrach dieses Gespräch.
 - B. hörte dieses Gespräch schweigend an.
 - C. berichtete dieses Gespräch nach Julianus' Tod seinen Freunden.
 - D. wusste nichts von diesem Gespräch.
19. Julianus sagt, dass
 - A. es feig ist, seinem Schicksal zu misstrauen.
 - B. er keine der Statuen sein möchte.
 - C. er hofft, noch lange zu leben.
 - D. niemand weiss, was die Zukunft bringen wird.
20. Um das Denkmal schaffen zu können,
 - A. benötigt Michelangelo nichts als seine eigenen Erinnerungen.
 - B. verlangt Michelangelo, dass die Freunde des Julianus ihm dessen Züge genau schildern.
 - C. verlangt Michelangelo, alle Abbildungen des Julianus zu sehen.
 - D. verlangt Michelangelo genügend Zeit und eine Menge Geldes.

Sie sah ihn ernst an. "Ich bin kein Engel, mein Herr. Was sollen wir anfangen? Wenn wir Mädchen einen Mann liebhaben, liefern wir uns ihm aus [ausliefern = surrender]. Wir trennen uns von allem, was vorher war, und kommen zu ihm. Da bin ich, sagen wir freundlich lächelnd. Ja, sagt er, da bist du, und kratzt sich hinterm Ohr. Und er flucht. Erst flucht er leise, später flucht er laut. Und wir sind allein, wie nie zuvor. Ich bin fünfundzwanzig Jahre alt und von zwei Männern wurde ich stehengelassen. Stehengelassen wie ein Schirm [Schirm = umbrella], den man absichtlich irgendwo vergisst. Stört Sie meine Offenheit?"

"Es geht vielen Frauen so. Wir jungen Männer haben Sorgen. Und die Zeit, die übrig bleibt, reicht fürs Vergnügen, nicht für die Liebe. Die Familie liegt im Sterben. Zwei Möglichkeiten gibt es ja doch nur für uns, Verantwortung [Verantwortung = responsibility] zu zeigen. Entweder der Mann verantwortet die Zukunft seiner Frau, und wenn er in der nächsten Woche die Stellung verliert, wird er einsehen, dass er verantwortungslos [verantwortungslos = irresponsibly] handelte. Oder er wagt es, aus Verantwortungsgefühl, nicht, einem zweiten Menschen die Zukunft zu zerstören, und wenn die Frau darüber ins Unglück gerät, wird er einsehen, dass auch diese Entscheidung verantwortungslos war."

21. Die Person, die zuerst spricht, ist
 - A. ein unerfahrenes Mädchen.
 - B. eine alte Frau.
 - C. ein Mädchen, das schlechte Erfahrungen gemacht hat.
 - D. sehr glücklich.

22. Der Mann, der ihr antwortet, sagt, dass
 - A. sie die Männer zu Unrecht beschuldigt.
 - B. es ihr eigener Fehler ist.
 - C. er sie liebt.
 - D. viele Mädchen solche Erlebnisse haben.

23. Er sagt ferner, dass
 - A. er Sorgen hat.
 - B. seine Familie im Sterben liegt.
 - C. ihn ihre Offenheit stört.
 - D. er eine Familie gründen möchte.

24. Er sagt, dass
 - A. keine Zeit fürs Vergnügen vorhanden ist.
 - B. keine Zeit für die Liebe übrig bleibt.
 - C. Zeit für die Liebe übrig bleibt, aber nicht fürs Vergnügen.
 - D. man in solcher Zeit weder an Liebe, noch an Vergnügen denken soll.

25. Diese Geschichte spielt in einer Zeit, in der junge Menschen
 - A. mit Zuversicht in die Zukunft sehen.
 - B. eine Revolution machen wollen.
 - C. ohne viel Hoffnung sind.
 - D. sich keinerlei Gedanken machen.

26. Sie spielt in einer Zeit, in der
 - A. junge Leute leicht ihre Stellung verlieren.
 - B. das Familienleben einen neuen Aufschwung [Aufschwung = growth] nimmt.
 - C. junge Leute es nicht wagen, offen miteinander zu sprechen.
 - D. das Familienleben den Einzelnen unterdrückt.

27. Die Person, die zuerst spricht,
 - A. beschuldigt die Männer, dass sie keine Engel sind.
 - B. sagt, dass die Männer es nicht gerne haben, wenn die Frau liebevoll zu ihnen kommt.
 - C. sagt, dass die Männer ihr nachlaufen.
 - D. sagt, dass sie ihren Schirm [Schirm = umbrella] vergessen hat.

V

Wenn man die vielen Schulen und Universitäten zum Lehren und Lernen sieht und das grosse Gedränge von Schülern und Meistern beobachtet, könnte man glauben, dass die Menschen sich wirklich sehr für die Wahrheit interessieren. Aber auch hier trügt [trügt = deceives] der Schein. Jene lehren, um Geld zu verdienen, und streben nicht nach Weisheit, sondern nach dem Schein und Kredit [Kredit = credit] derselben; und diese lernen nicht, um Kenntnisse und Einsicht zu erlangen, sondern um schwatzen [schwätzen = prattle] zu können und um gelehrt zu erscheinen. Alle dreissig Jahre nämlich tritt ein neues Geschlecht auf, das von nichts weiss und nun die Resultate des durch die Jahrtausende angesammelten menschlichen Wissens in aller Geschwindigkeit in sich fressen und dann klüger als alle Vergangenheit sein will. Zu diesem Zweck geht der moderne Mensch auf Universitäten und greift nach den Büchern, und zwar nach den neuesten. Nur alles kurz und neu! wie er selbst neu ist. Dann urteilt er über alles.

28. Der Autor
- A. glaubt, dass die meisten Menschen vom Wunsch erfüllt sind, die Wahrheit zu lernen.
 - B. hofft, dass die meisten Menschen bestrebt sind, die Wahrheit zu lehren.
 - C. glaubt, dass die meisten Menschen nur so tun, als ob sie sich wirklich für die Wahrheit interessieren.
 - D. hofft, dass die meisten Menschen nur so tun, als ob sie sich wirklich für die Wahrheit interessieren.
29. Der Autor
- A. klagt, dass es so wenig Schulen gibt.
 - B. sagt, dass es viele Schulen gibt.
 - C. klagt, dass es so viele Schulen und keine Universitäten gibt.
 - D. sagt, dass es viel zu viele Schulen und Universitäten gibt.
30. Er behauptet, dass die Schüler
- A. nur lernen, um sich den Anschein der Bildung zu geben.
 - B. nichts lernen.
 - C. Kenntnisse und Einsicht erlangen.
 - D. mehr wissen als die Lehrer.
31. Der Autor behauptet ferner, dass jedes neue Geschlecht
- A. darunter leidet, dass es sich für weniger vernünftig hält als die Vergangenheit.
 - B. klüger als die Vergangenheit sein will.
 - C. mehr als die vergangenen lernen will.
 - D. klüger ist als die Vergangenheit.
32. Der Autor
- A. hat grosse Hochachtung für Universitätslehrer.
 - B. hat nicht viel Achtung für Universitätslehrer.
 - C. hat nicht viel Achtung für Gelehrsamkeit [Gelehrsamkeit = scholarship].
 - D. hält grosses Wissen für überflüssig.
33. Er sagt, dass Universitätslehrer
- A. nur lehren, um Geld zu verdienen.
 - B. nur lernen, um schwätzen zu können.
 - C. nur schwätzen, um gelehrt zu erscheinen.
 - D. alle dreissig Jahre ihre Ansichten wechseln.
34. Der Autor sagt, dass der moderne Mensch
- A. zu viele Bücher liest.
 - B. nicht die richtigen Bücher liest.
 - C. die neuesten Bücher liest.
 - D. die grossen Meisterwerke lesen sollte.

VI

Die Stadt Göttingen, berühmt durch ihre Würste und Universität, gehört dem Könige von Hannover und enthält 999 Feuerstellen, verschiedene Kirchen, ein Gefängnis und einen Ratskeller, wo das Bier sehr gut ist. Die Stadt selbst ist schön und gefällt einem am besten, wenn man sie mit dem Rücken ansieht. Sie muss schon sehr lange stehen; denn ich erinnere mich, als ich vor fünf Jahren dort studierte, hatte sie schon dasselbe graue, altkluge Aussehen und war schon vollständig eingerichtet mit Nachtwächtern, Dachshunden, Wäscherinnen, Professoren und Studenten. Im allgemeinen werden die Bewohner Göttingens eingeteilt in Studenten, Professoren, Bürger und Vieh, welche vier Stände doch nicht streng geschieden sind. Der Viehstand ist der bedeutendste. Die Namen aller Studenten und aller ordentlichen und unordentlichen Professoren hier aufzuzählen, wäre zu weitgehend; auch sind mir in diesem Augenblick nicht alle Studentennamen im Gedächtnis, und unter den Professoren sind manche, die noch gar keinen Namen haben.

35. Dies ist von einem Schriftsteller geschrieben, der seine Leser
- A. belehren will.
 - B. erheitern will.
 - C. ärgern will.
 - D. verachtet.
36. Der Schriftsteller
- A. lebte seit seiner Jugend in dieser Stadt.
 - B. lebt seit fünf Jahren in dieser Stadt.
 - C. lebte vor fünf Jahrzehnten in dieser Stadt.
 - D. lebte vor fünf Jahren in dieser Stadt.
37. Die Stadt enthält
- A. neunundneunzig Feuerstellen.
 - B. neunhundertneun Feuerstellen.
 - C. neunhundertneunundneunzig Feuerstellen.
 - D. neuntausendneunhundertneunundneunzig Feuerstellen.
38. Wir erfahren, dass
- A. die Stadt sehr schön ist.
 - B. man wohl daran tut, sich die Stadt nicht anzusehen.
 - C. die Stadt sehr ausgedehnt ist.
 - D. die Stadt sehr bunt und farbenvoll ist.
39. Es wird uns erzählt, dass das Bier
- A. in den Kirchen und dem Ratskeller sehr gut ist.
 - B. im Ratskeller sehr gut ist.
 - C. im Gefängnis und im Ratskeller sehr gut ist.
 - D. untrinkbar ist.
40. Als der wichtigste Teil der Einwohner der Stadt
- A. wird das Vieh bezeichnet.
 - B. werden die Professoren bezeichnet.
 - C. werden die Bürger bezeichnet.
 - D. werden die Studenten bezeichnet.
41. Es wird gesagt, dass
- A. alle Professoren der Universität sehr berühmt sind.
 - B. manche Professoren sehr berühmt und die anderen bekannt sind.
 - C. manche Professoren unbedeutend oder unbekannt sind.
 - D. alle Professoren unbedeutend oder unbekannt sind.