

847118

~~SECRET~~

ms

847118

RUSSIAN METHODS OF INTERROGATING

CAPTURED PERSONNEL

WORLD WAR II

By

KERMIT G. STEWART

Major, Infantry, United States Army

OFFICE OF THE CHIEF OF MILITARY HISTORY

DEPARTMENT OF THE ARMY

00935

Eq 908d CIC Det
Log S- 15473

File Copy
Must be forwarded to
Document File Section
G-2, U. S. Army
within two weeks

~~SECRET~~

S E C R E T

Note: A separate volume of appendices to accompany this study, "Russian Methods of Interrogating Captured Personnel," will be published and distributed at a later date.

S E C R E T

S E C R E T S E C R E T

R U S S I A N M E T H O D S
O F
I N T E R R O G A T I N G C A P T U R E D P E R S O N N E L
W O R L D W A R I I

B Y
K E R M I T G . S T E W A R T
M a j o r , (I n f) G S C

W A R N I N G

This document contains information affecting the national defense of the United States within the meaning of the Espionage Laws, Title 18, U. S. C., sections 793 and 794. The transmission or the revelation of its contents in any manner to an unauthorized person is prohibited by law.

O F F I C E O F T H E C H I E F O F M I L I T A R Y H I S T O R Y
D E P A R T M E N T O F T H E A R M Y
1951

S E C R E T S E C R E T

S E C R E T

S E C R E T

F O R E W O R D

The Office of the Chief of Military History has undertaken the preparation of various special studies needed in the Army School System and for staff reference. Such projects were initiated more than three years ago when a canvass of general and special staff sections of the Army resulted in requests for studies on a wide variety of subjects. In many cases the need for such studies was found to be greatest in matters pertaining to foreign military methods. This study is intended to provide the Army with information on Russian interrogation methods in a condensed and readily usable form. It has been made at the request of the Assistant Chief of Staff, G-2, GSUSA.

A considerable volume of material is available for research on Soviet methods of interrogation. The Russians, however, are extremely secretive, and there are many gaps in our knowledge of their operations and methods, particularly at the higher levels of the Soviet governmental and military structure. It is felt that this study will fill in some of the missing pieces of the Soviet puzzle. If it stimulates further investigation to gain yet more complete knowledge of Russian methods, the continuing value of the study will be enhanced.

Washington, D. C.
September 1951

(Signature)
ORLANDO WARD
Major General, USA
Chief, Military History

S E C R E T

S E C R E T

S E C R E T

S E C R E T

P R E F A C E

The primary purpose of this study is to provide a reference work on Russian methods of interrogation for students in the Army School System, particularly for those in the field of intelligence. This work is also intended for use as a reference by those who determine what instructions a United States soldier will receive concerning his conduct in the event of capture by the armed forces of the Soviet Union or its satellite nations.

The scope of this study is considerably broader than indicated by the title. The general treatment accorded prisoners of war by the Soviets during World War II is balanced against a history of prisoner treatment through the ages. Soviet attitudes regarding the rules of land warfare surrounding prisoners are compared with the attitudes of other peoples. A brief description of the governmental and military structure of the Soviet Union has been presented in order that the student may better understand the part played by the interrogation program in the over-all intelligence plan of that nation. Soviet intelligence procedures, prisoner evacuation, prison camp conditions, and the prisoner indoctrination program are discussed to the extent necessary to lead to a better understanding of the interrogation program.

In the hands of the Soviets, interrogation is not only a means

S E C R E T

S E C R E T

SECRET

SECRET

of gathering information but also a political weapon. The startling confessions made in the Soviet purge trials of the late 1930's or, more recently, in the Hungarian trials of Cardinal Mindszenty and Robert Vogler have testified to the effectiveness of communist methods of "political" interrogation. In this study such methods are touched upon because they were used with a very limited number of prisoners of war. Otherwise, the discussion has been confined to methods used to gain tactical and strategic information from captured military personnel during and immediately after World War II.

Since this study is intended for use as a reference, which means that only isolated parts of the work will be read by many individuals, certain facts and ideas have been repeated from time to time in order to permit each phase of the study to stand alone as a self-contained thesis.

The author has been allowed complete freedom in research and in developing his ideas, and for this he is truly grateful. A sincere attempt has been made to write a factual, objective narrative, devoid of bias. In occasional instances when only assumptions could be made because of insufficient evidence, they have been frankly labeled as such. The author takes full responsibility for these assumptions, for statements of fact, and for conclusions found in the text. It must be emphasized that the recommendations contained in the final chapter represent the views of the author and do not necessarily

SECRET

SECRET

SECRET

SECRET

reflect the views or policies of the Department of the Army.

The writer has received much help, beginning with the original outline and continuing through the stages of researching, writing, and editing. Brig. Gen. P. M. Robinett, USA-Ret., Chief, Special Studies Division, Office of the Chief of Military History, contributed many valuable suggestions, smoothed the way for more complete research than would otherwise have been possible, and offered constructive criticism and guidance throughout the project. Lt. William Klepper, Jr., carefully researched the records of the German Military Documents Section and located many documents which were of primary importance to this study; Lt. George L. Frenkel's painstaking review of the manuscript and his correction of many translations of German documents have resulted in a much improved, more accurate study. Lt. Col. Robert E. Work, USAF, was most co-operative in making available Air Force records for this project, and his constructive suggestions and criticisms were much appreciated by the author. Mr. Israel Wice and his assistants have given valuable aid in securing source materials; the Foreign Studies Branch, Office of the Chief of Military History; the Office of the Assistant Chief of Staff, G-2, GSUSA and CHQ, FEC; the Departmental Records Branch, AGO; the Historical Section, EUCCOM; the Army Library; and the American Red Cross have all been most co-operative. It has been a pleasure to work with Miss Lucy Weidman who has edited the final draft of the manuscript; Mrs. Frances T. Fritz

SECRET

SECRET

SECRET

SECRET

did the preliminary editing of the first draft of the narrative. Mr. Frank J. Ford is responsible for the first chart, the other six being the work of Mr. Elliott Dunay. Mrs. Irene Wilhelm has been helpful in administrative matters and has assisted with the typing; Mrs. Laurie Herring has assiduously typed and retyped the manuscript and cut most of the stencils for this mimeographed edition of the study.

References in the footnotes give credit only to a few of the many persons who have been called upon to give information. Personnel of the Office of the Assistant Chief of Staff, G-2, GSUSA, of the Directorate of Intelligence, USAF, and of the Office of the Chief of Naval Intelligence, USN, have reviewed the manuscript; their comments and criticisms have been invaluable.

Washington, D. C.
September 1951

KERMIT G. STEWART
Major, (Inf) GSC

SECRET

SECRET

SECRET

CONTENTS

SECRET

PART ONE

Chapter	Page
I SCOPE AND PURPOSE OF THIS STUDY	1
II SOME ASPECTS OF INTERNATIONAL LAW	9
III THE GROWTH OF CUSTOMS AND LAWS REGARDING PRISONERS	20
IV THE GENEVA (PRISONERS OF WAR) CONVENTION OF 1929.	42
A. <u>Summary of Certain Protective Provisions of the Convention.</u>	42
B. <u>Status of the Major Powers in Relation to the Geneva Convention During World War II.</u>	47
V SOVIET PRACTICES IN THE FIELD OF INTERNATIONAL LAW.	55

PART TWO

VI NATIONAL DEFENSE SYSTEM OF THE USSR	69
A. <u>General</u>	69
B. <u>Government of the USSR and the Communist Party.</u>	70
C. <u>Soviet Military and Para-Military Forces.</u>	75
1. <u>The Supreme Command</u>	75
2. <u>Field Organizations of the Red Army</u>	81
3. <u>Intelligence Functions of the General Staff and the Main Intelligence Directorate (GRU).</u>	86
4. <u>Staff Organization and the Intelligence Sections of Red Army Field Organizations</u>	93
5. <u>Soviet Para-Military Political, Security, and Counterintelligence Agencies</u>	104
a. <u>The Main Political Directorate</u>	105
b. <u>The History of the Soviet Secret Service.</u>	107
c. <u>The NKVD.</u>	111
d. <u>Main Counterintelligence Administration of the Armed Forces (GUKR).</u>	120
D. <u>Summary</u>	128

SECRET

SECRET

Chapter	SECRET	SECRET	Page
VII	SOVIET REGULATIONS REGARDING PRISONERS OF WAR		136
	A.	General	136
	B.	Soviet Instructions Issued in 1940	138
		The Importance of Taking Prisoners	140
		Procedure for Collecting and Evacuating Prisoners	141
		Interrogation of Prisoners	149
	C.	Red Army Adherence to Instructions Concerning Prisoners	159
	D.	The 1942 Soviet Field Regulation	164
	E.	Subsequent Orders and Directives	166
	F.	Political Interrogation Directives	170
	G.	Summary	175
VIII	SELECTION AND TRAINING OF INTERROGATIONS AND INTERPRETERS		178
	A.	Interrogation Personnel	178
	B.	Selection and Training of Intelligence Officers	182
	C.	Training in the Field	187
	D.	Soviet Air Force Intelligence Officers	188
	E.	NKVD Interrogation Personnel	189
	F.	Selection and Training of Interpreters	191
	G.	Summary	196
IX	INSTRUCTIONS FOR SOVIET CAPTURED PERSONNEL AND TREATMENT OF REPATRIATED PRISONERS		198
	A.	Indoctrination and Training	198
	B.	Treatment of Repatriated Soviet Prisoners	202
	C.	Summary	206
X	SOVIET METHODS OF INTERROGATING GERMAN PRISONERS OF WAR		208
	A.	Phases of Prisoner Treatment	208
	B.	Soviet Interrogation Methods as Applied in the Field	215
		1. Some Aspects of Soviet Intelligence Doctrine	215
		2. Russian Characteristics Affecting Interrogation Methods	216
		3. Interrogation in Combat Echelons of the Red Army During the First Stage of the War	220
		4. Interrogation in Combat Echelons of the Red Army During the Second and Third Stages of the War	233

x

SECRET

SECRET

Chapter	SECRET	SECRET	Page
	a.	Military Interrogations in the Field	233
	b.	Political Interrogations in the Field	244
	c.	Smersh Interrogations in the Field	248
C.	Soviet Interrogation Methods Applied in Prisoner-of-War Camps		257
	1.	General Conditions in the Camps	257
	2.	Camp Interrogation Methods	275
	a.	The Five Phases of the Camp Interrogation Program	275
	b.	Administration of the Camp Program	283
	c.	General Methods of Interrogation	288
		Coercive Techniques	289
		Indirect Techniques	291
		The Use of Informers Among Prisoners	293
	d.	Specific Methods of Interrogation	295
		First Phase of the War	295
		Second and Subsequent Phases of the War	298
	e.	Interrogation Prisons	314
	f.	The Use of Drugs in Interrogations	324
	g.	Interrogation of War Criminals	332
	D.	Summary	344
PART THREE			
XI	SOVIET METHODS OF INTERROGATING JAPANESE PRISONERS OF WAR		357
	A.	General Conditions in the Camps	357
	B.	Camp Organization and Administration	360
	C.	Camp Indoctrination Program	362
	D.	Camp Interrogation Methods	366
	E.	Summary	374
PART FOUR			
XII	CONCLUSIONS		376

xi

SECRET

SECRET

SECRET

SECRET

NOTES AND CITATIONS

	Page
Explanatory Note	383
Chapter I	385
Chapter II	388
Chapter III	390
Chapter IV	397
Chapter V	399
Chapter VI	401
Chapter VII	414
Chapter VIII	420
Chapter IX	423
Chapter X	426
Chapter XI	446
Chapter XII.v	448
GLOSSARY	449

ORGANIZATIONAL CHARTS

	Facing Page
Figure 1, Prisoner Evacuation: Soviet Armed Forces, World War II	68
Figure 2, State Administrative Structure, USSR (1945)	70
Figure 3, Command and Administration of the Red Army	82
Figure 4, Main Intelligence Directorate (GRU), 1945	86
Figure 5, Organizational Plan and Channels of Command, Red Army Formation (Army Group)	94
Figure 6, Organization of the Peoples' Commissariat of Internal Affairs	112
Figure 7, Organization of the Main Directorates of Prisoner-of-War Camps and Guard and Escort Troops of the MVD (Postwar -- 1947)	114

NOTE: The Appendixes (1 - 9) are contained in a separate volume.

SECRET

SECRET

SECRET

SECRET

PART I

CHAPTER I

SCOPE AND PURPOSE OF THIS STUDY

This is a study of Russian methods of interrogating captured personnel during and immediately after World War II. The discussion will be limited as nearly as possible to methods used in dealing with prisoners of war although some of the methods have been used more frequently with political and criminal offenders in the Soviet Union and its satellite states.

The importance of prisoner interrogation has been emphasized in Soviet military doctrine and practice. Explicit directions for processing prisoners have been found in practically all handbooks issued to the various arms and services of the Red Army. Soviet training films have emphasized that the "eyes and ears" of prisoners should be used as much as possible in planning attack or defense.¹ The capture of prisoners for purposes of interrogation has played such a prominent part in Soviet tactics that commanders have often specified in reconnaissance directives the sectors from which prisoners were to be taken.²

Soviet emphasis on the importance of prisoner interrogation is not unique. Prisoners have been considered valuable sources of information by belligerents throughout the history of warfare,³ and

SECRET

SECRET

SECRET

SECRET

during World War II all the major powers carried on extensive prisoner-interrogation programs.

The tremendous number of prisoners taken during World War II served to increase the importance of the interrogation program.⁴ Literally millions of Germans fell into Russian hands during the war, the exact number being held at the time of Germany's surrender will probably never be known. More than a million Japanese soldiers and civilians were captured by the Red Army during its eleven-day war with Japan.⁵ Russia, in turn, lost millions of troops to the Germans.⁶ France, Poland, England, the United States, and other powers engaged in the war also experienced heavy losses of personnel through capture.⁷ Additional millions of civilians suffered imprisonment as internees and slave laborers or as political and "racial" offenders in concentration camps.

With huge quantities of the raw material of intelligence available in the form of prisoners, the various belligerents took steps to insure the fullest possible exploitation of prisoner information. Field regulations and special orders issued to combat troops specified procedures for processing and evacuating prisoners in ways designed to insure their immediate and maximum utilization for intelligence purposes. Large numbers of military intelligence personnel were especially trained as interrogators and as linguists. Specialized agencies such as translator and interrogation teams were

SECRET

SECRET

SECRET

SECRET

organized to exploit captured documents and to interrogate prisoners, and subdivisions were created within existing intelligence services to process prisoner information.

The emphasis on the prisoner-interrogation program quite naturally led to the adoption of appropriate counterintelligence measures by the various belligerents. Troops were told of their rights as prisoners under international law, cautioned about known tricks and stratagems employed by the enemy to secure information from prisoners, indoctrinated with principles of loyalty to be practiced when in captivity, and warned of punishment which would be inflicted if it were learned that an individual had deserted or willingly given information to the enemy.⁸

In this study, Soviet methods of exploiting prisoners for intelligence purposes will be described in as much detail as possible. A brief discussion of the wartime organization of the government of the USSR and of the Soviet Armed Forces will be followed by a more extensive discussion of Soviet military intelligence services and the organizational changes which took place during the war. For most nations this would be sufficient background for an understanding of their prisoner-interrogation programs. The Soviet Union, however, had a highly centralized government and many intelligence organizations with over-lapping functions. The discussion, therefore, cannot be confined to the military organization alone but must include

SECRET

SECRET

SECRET

various para-military intelligence and security organizations, especially the Peoples' Commissariat of the Interior (NKVD) which was responsible for the operation of prisoner-of-war camps and for the strategic interrogation program in those camps.

Soviet field regulations and special directives pertaining to the handling and interrogation of prisoners, the selection and training of intelligence personnel, counterintelligence measures, specific methods and practices of Soviet interrogators, and other aspects of the prisoner-interrogation program will be given as complete an exposition as is possible within the limitations of research materials presently available. The general treatment of prisoners during evacuation and in the camps and the camp-propaganda program will be discussed in so far as these aspects of the life of a prisoner in Russia were related to interrogation procedures. Since interrogations of prisoners in the field and in the camps were conducted by different agencies and for different purposes, separate treatment will be given to these two phases of interrogation. Separate treatment will also be given to Russian methods of interrogating Japanese prisoners since this was almost entirely a post-war development.

Excerpts from a large number of documents upon which this study is based appear in the appendix. Many of these "case histories" are spectacular in nature and, if included in the text, would tend

SECRET

SECRET

SECRET

to focus the reader's attention on specific incidents rather than lead to a general understanding of method. In so far as possible, the text of this study will deal with methods of interrogation in general terms. The documentary excerpts in the appendix will be used to illustrate certain methods described and to support various conclusions and evaluations appearing in the text.

In order to achieve a better understanding of Russian methods of interrogating prisoners, the first part of this study will deal with some broad aspects of the problems created by taking prisoners in modern warfare. Included will be a brief discussion of international law as it pertains to prisoners of war; a short history of the treatment accorded prisoners from ancient times to the present; mention of the principal codes, treaties, and multipartite conventions concerning prisoners which have been framed in the past two hundred years; and special mention of the Geneva Prisoners of War Convention of 1929 with comments on the degree to which the major belligerents of World War II adhered, or failed to adhere, to that treaty.

Germany was signatory to the Geneva Convention of 1929, but the Soviet Union was not. Despite German offers to apply the provisions of the convention to Russian prisoners on a reciprocal basis, the Russians persisted in refusing to make any commitments on the matter. The result was a state of lawlessness between these two

SECRET

SECRET

SECRET

SECRET

powers in so far as their prisoners were concerned. Both nations were engaged in total war, a type of conflict which has become almost institutional in the twentieth century. They were also engaged in an ideological conflict, and the opposing, but equally fanatical, ideologies of Communism and Nazism transformed a chronic antagonism between the two peoples into a bitter hatred. The combined effect of these aggravating circumstances was a noticeable deterioration in the field of humanitarianism and an uptrend of brutalization. Some aspects of the effect of Communism on Soviet attitudes toward that portion of international law pertaining to prisoners of war will be given separate treatment in this study.

Because of the place of the Soviet Union in world affairs and the nature of the Communist dictatorship, the Russians have become probably the most security conscious people on earth. They have been especially secretive about their methods of handling prisoners. As a result, there are many unfilled gaps in the information which is currently available and upon which this study is based. Most of the information has come, either directly or indirectly, from German sources. An important direct source has been the German Military Documents Section (GMDS), Departmental Records Branch, Office of the Adjutant General. These files, most of which were captured from the German Army at the close of World War II, have

SECRET

-6-

SECRET

SECRET

SECRET

yielded not only information on Soviet methods but a number of Soviet documents concerning treatment of prisoners. A group of former German staff officers working in co-operation with the Historical Division of the United States European Command have also made an important contribution to this study in the form of monographs on Soviet methods of interrogating and propagandizing prisoners of war. ¹⁰ Some of these former officers who fought against the Russians during the war were captured by the Red Army. In gathering material for their monographs they questioned many former German soldiers now returned from Russian captivity.

Other information has been gleaned from these same returned prisoners and from Soviet deserters by United States Army and Air Force intelligence agencies in Europe and America. Soviet methods of handling Japanese prisoners have been learned from Japanese repatriates by United States intelligence agencies in Japan. The text is fully footnoted as to the sources of the information, with appropriate comments on the conjectures or conclusions which are based on an inadequate number of case histories or upon information of questionable reliability.

This study, comprising both a historical review and a critical analysis of Russian methods of interrogating captured personnel, is written with a twofold purpose: (1) to point out the successful methods that might well be adopted in future combat and at the same

SECRET

-7-

SECRET

SECRET SECRET

time to weed out the ineffective or faulty methods; and (2) to provide the planners, especially those concerned with prisoner-interrogation, counterintelligence, troop-training, and troop-information programs, with information on which to base countermeasures to be taken and training programs to be instituted in the event of war with the nation whose combat methods are under study.

SECRET SECRET

SECRET SECRET

CHAPTER II

SOME ASPECTS
OF INTERNATIONAL LAW

In ancient times a captive was, in most cases, completely subject to the mercy of his individual captor. The latter's conduct as it affected his prisoner was limited by no restrictions other than those imposed by his personal code of ethics or, as society developed, by the code of the social group to which he belonged. As civilization progressed, however, a considerable change took place in the status of a military captive. He became a captive of the nation to which he had surrendered rather than of the individual who made the capture, and nations, in turn, accepted varying degrees of responsibility for the welfare of captives. The rights which gradually accrued to prisoners included that of withholding certain information from captors if prisoners so desired. Rules which most nations have accepted in regard to their treatment of prisoners are among that group of laws known as the rules of land warfare which, in turn, are a part of the larger body of international law.

A modern nation, whether engaged in war or peace, is entitled to certain rights and has certain duties to fulfill under international law. This body of customs, usages, and rules which affects

SECRET SECRET

SECRET

SECRET

and to an extent governs the relations and intercourse of states with one another has been formulated as a result of commercial and political transformations which took place during the fifteenth and sixteenth centuries when western civilization was undergoing the transition from the Middle Ages to the era of modern history. During that period the feudal system was transformed into a group of well-defined territorial states with the governments of the latter assuming supreme authority within their boundaries. The process of change, it is generally agreed, was completed by the Treaty of Westphalia (1648) which securely established the territorial state as the characteristic feature of the modern political system.¹

Under current conceptions of international law, a state (or nation) has been defined as "the external personality or outward agency of an independent community" which has as its attributes "(a) possession of sovereign power to pledge the community in its relations with other similarly sovereign communities, (b) independence of all external control, and (c) dominion over a determinate territory."² Thus, while a state recognizes no higher lawgiving authority, it can still pledge itself to maintain certain specified relations with other states.

Despite the fact that the old system of feudalism had evolved into a system of separate territorial states, these states maintained

SECRET

SECRET

-10-

SECRET

SECRET

continuous relations with one another, and it was inevitable that certain rules should be adopted which would assure a measure of order and mutual understanding in these relationships. By the very nature of the new order, it was necessary for states to agree on common frontiers and on the conditions under which they could acquire valid title to new territories; inter-state commerce, trade, and finance, necessary to the continued existence of many nations, could flourish only under a system of mutual agreements and understandings. Even when the relationship was one of war, nations found it to their advantage to conduct hostilities within the bounds of certain rules which could be flouted only at the expense of losing the advantage of those rules for themselves. In the past four hundred years the structure of international law has been raised into an imposing edifice consisting of thousands of treaties, decisions of international and domestic tribunals, informal agreements, usages, and customs. In the latter part of this period custom has largely been replaced by the treaty or convention.

International law has a highly complex character, and definitions which have been advanced by authorities are usually long statements containing numerous qualifying clauses concerning origin and function.³ The definition quoted below will serve to define the term as it is used in this study. The quotation is an excerpt from a dissenting opinion offered by Judge Fred K. Neilson in the International Fisheries

SECRET

SECRET

-11-

SECRET

SECRET

Company Case of 1931:

International law is a law grounded on the general assent of the nations. . . . Its sources are treaties and customs, and the important sources of evidence of the law are judicial decisions of domestic and international tribunals, certain other kinds of public governmental acts, treaties and the writings of authorities. The existence or non-existence of a rule of international law is established by a process of inductive reasoning; by marshaling various forms of evidence of the law to determine whether or not such evidence reveals the general assent that is the foundation of the law. No rule can be abolished, or amplified, or restricted in its operation, by a single nation or by a few nations or by private individuals acting in conjunction with a Government. No action taken by a private individual can contravene a treaty or a rule of international law, although it is the duty of a Government to control the action of individuals, with a view to preventing contravention of rules of international law or treaties.⁴

It would seem that the principal basis for international law is the general assent of the nations concerned. In this respect, the rules to which nations have agreed to conform in their relationships with one another have the same inherent force as the customary law of primitive society or the ideal statutes of a democratic government: their authority is founded on consent. Even though there is no higher lawgiving authority which can punish transgressors, states obey international law because they have recognized the inherent worth or necessity for a law and have therefore consented to obey, although the number of assents a rule of action needs in order to be recognized as a rule of international law has never been determined. Neither is it possible to establish with precision the status of a given law either now or at any specific moment in the past.⁵

SECRET

SECRET

-12-

SECRET

SECRET

But, nevertheless, it is a mistake to assume that international law is not observed or that it does not have a binding character. During its four centuries of existence, international law has in most instances been scrupulously observed.⁶

To recognize the existence of international law as a binding legal system is not tantamount to its recognition as an effective legal system. When serious differences in national interests or opinion have occurred, the subject matter of those disagreements has generally been ignored in treaties, or, if agreed upon, adherence has been far from general.⁷

There is no established mechanism by which applicability of a rule of international law can be determined with precision, and no specific sanctions exist which can be employed to assure adherence. Various international courts have been established, but their jurisdiction has been limited to those states willing to submit disputes for adjudication. "It is axiomatic in international law that no state can be compelled against its will to submit a dispute with another state to an international tribunal."⁸

Probably the most reliable and potent force which ensures adherence to international law is public opinion, especially when that opinion is based on the social ethics of the people of one nation or of several nations. Public criticism can bring about concrete sanctions against an offending nation: boycotts, embargoes, the severing of

SECRET

SECRET

-13-

SECRET

SECRET

diplomatic and trade relations, various forms of reprisal, the seizure of hostages, or war. Within a state, public opinion can bring about a change of policy on the part of governmental officials, or it may bring about the fall of the government.

In time of war, one of the most effective sanctions which can be employed to enforce international law is the reprisal. Rules of warfare can exist only when belligerents find it to their mutual advantage to adhere to those rules; non-adherence results in reprisals which negate both the rules and the advantages. Laws concerning the treatment of prisoners of war are of a type which belligerents have found to be mutually advantageous from a military standpoint and are more likely to command respect than laws limiting the use of weapons or the destruction of enemy forces and resources.

An example of how reprisals can negate both rules and advantages occurred early in World War II. During the attempted landing at Dieppe in 1942, Canadian troops handcuffed some captured Germans on the battlefield as a security measure. This was adjudged a technical violation of the Geneva Convention by German military authorities who proceeded to shackle a large number of Allied prisoners in retaliation, thereby setting off a "chain-reaction" of reprisals which for a time threatened the existence of all rules of land warfare. The resultant diplomatic deadlock was broken only by the International Red Cross Committee which, after much negotiation, was successful

SECRET

SECRET

SECRET

SECRET

10
in bringing an end to the reprisals. This Committee, which has had much practical experience in persuading nations to uphold international law, observed in its World War II report: "Generally speaking, the rules of international law are implemented only on the basis of reciprocity. Practical success depends, however, not only on legal reciprocity, but also on one national interest balancing with the other. Reciprocity in this sense may rest upon interest, unlike in kind, but existing at the same moment."

11
Fear of reprisals may have been the only factor which caused Germany toward the end of World War II to maintain its adherence to the Geneva Convention in regard to Allied prisoners. Early in 1945 the Nazis had seriously considered denouncing that Convention, but German military leaders feared reprisals against captured German personnel.

12
Adherence to international law on the part of individual citizens of a state is ensured to a limited degree when that state officially ratifies a treaty or convention. The act of ratifying a treaty carries with it the implication that the ratifying states will require their citizens to obey the terms of that treaty. In the United States this implication is confirmed by law. Article Six of the Constitution of the United States provides: "This Constitution and the laws of the United States which shall be made in pursuance thereof and all treaties made, or which shall be made, under the

SECRET

SECRET

SECRET

SECRET

authority of the United States, shall be the supreme law of the land. . . ."

Upon ratification by Congress, the Geneva Convention of 1929 became law for all citizens of the United States; the armed forces were obliged to incorporate its terms in their regulations, to instruct all military personnel as to their rights and duties under the Convention, and to treat prisoners who were citizens of adhering states in accordance with its provisions.¹³ Thus, international law which has been codified in treaties has at least some of the attributes of municipal law for citizens of the ratifying states. There are other factors inherent in the concept of treaty law, however, which tend to nullify the theory that by codification the problem of adherence is solved.

The sovereign authority of states which, in theory, is the bulwark of treaty law, proves, in practice, to be a source of weakness. While sovereignty may confer authority to enter into a treaty, it also confers authority to release the state from that treaty since sovereignty is incompatible with obligation.¹⁴ States have from time to time renounced or violated treaties for a variety of reasons: unfavorable treaties forced on weak or defeated nations have been renounced when those nations recovered sufficient strength to defy their oppressors; arrogant or irresponsible governments of powerful states have forced their will on others in deliberate defiance of

SECRET
-16-

SECRET

SECRET

SECRET

existing agreements; the realities and dire necessities of war have often voided idealistic, unrealistic, or outdated rules of warfare adopted in time of peace or in previous wars.

Within a state, the status of municipal law is determined precisely by the courts. Herein lies the important difference between municipal law and treaty law: save for a few international courts which have had permissive and declaratory, rather than arbitrary, authority, no agency for the interpretation of treaty law exists on the international level, and states are free to interpret the terms of treaties in the light of changing national interests, necessities, and ethics. It should also be remembered here that the threat of punishment for transgressors has never yet succeeded in preventing violations of municipal law.

Finally, abstract theories regarding the sanctity and force of treaties give way to the hard fact that the terms of treaties are, in practice, based either upon the differences in strength between the contracting parties or upon the degree of usefulness of the treaty to all parties. Using this criterion, treaties may be divided into two groups: those forced on the weak by the strong and those which are of mutual benefit to the contracting states.¹⁵ The rules of warfare in general, and particularly those applying to prisoners of war, belong to the second group.

SECRET

SECRET

SECRET

SECRET

Despite numerous attempts to codify the rules in treaties and conventions, certain unwritten customs and usages which are well defined and recognized by civilized nations remain in force. During a war, these unwritten rules are of special importance. War is a reversion to primitive methods of self-preservation which knows no law save that of survival, and to have any rules governing the conduct of hostilities is something of a paradox. The weakness of treaties and conventions, the effect of new methods and weapons, and the other factors which tend to nullify the force of written rules during hostilities serve to increase the importance of certain customs of warfare.

Among the unwritten rules of war recognized by most civilized nations are three interdependent basic principles: (1) the principle of military necessity under which a belligerent is justified in applying any amount and kind of force to compel the submission of the enemy with the least expenditure of time, life, and money; (2) the principle of humanity prohibiting any violence not actually necessary for the purpose of war; and (3) the principle of chivalry which prohibits the resort to dishonorable means, expedients, or conduct.¹⁶

The rules of warfare are particularly susceptible to rapid change, and it is sometimes difficult to determine whether variations are the result of violations or due to the effect of practical developments. Rules codified in times of peace tend to emphasize humanitarian

SECRET
-13-

SECRET

SECRET

SECRET

considerations to an unrealistic degree. Such rules quickly fall by the wayside as social ethics and morality change under the realities of war, and only necessity, humanity, and chivalry are left as guiding principles. Even these broad, general principles are subject to violation by the more ruthless combatants.

"Total war" as practiced by belligerents between 1939 and 1945 rendered obsolete many rules of long-standing, and belligerents fell back more and more on the unwritten rules of warfare to justify violations of the written codes. Of these rules, the maxim of necessity was used to justify violations more than any other as the importance of actions banned by treaties became so great as to warrant violation. No sanctions have as yet been devised or employed to enforce the rules of warfare which can counterbalance the force of military necessity.¹⁷

The treatment of prisoners is strongly influenced by necessity in warfare and cannot be considered apart from the current social, economic, and military situation existing in the nation which is holding captives. It is only by reference to these conditions that treatment accorded to prisoners can be explained and evaluated. A brief summary of practices in the past and of modern developments will provide a background for an evaluation of Russian practices during World War II.

SECRET

SECRET

-19-

SECRET

SECRET

CHAPTER III

THE GROWTH OF CUSTOMS AND LAWS
REGARDING PRISONERS

Despite many periods of regression, the treatment accorded prisoners of war, from a humanitarian standpoint, has gradually improved through the years. This is not to say that the behavior of captors has been consistent during any one period. The most fierce of ancient warriors occasionally indulged generous and merciful impulses toward their captives while certain of the World War II belligerents visited acts of utmost savagery on their captured foes. During the twentieth century several of the most idealistic conventions regarding prisoner treatment yet written have been ratified by most of the nations of the world. This humanitarian advance has been countered by the rise of certain ideologies which have largely disregarded the acquired rights not only of prisoners of war but also of free citizens, and there is evidence that humanity, in some quarters at least, is suffering a period of regression in regard to prisoner treatment.

In ancient times there was no legal distinction between combatant and non-combatant. Early tribal conflicts were usually wars of extermination. Warriors, farmers, tradesmen, women, and children fell into the same category so far as the belligerent was concerned;

SECRET

SECRET

SECRET

SECRET

no quarter was expected, asked, or given. The individual was identified with the tribe or social group, and defeat meant loss of life, liberty, and possessions for all. ¹ Massacres of captives were often preceded by systematic or ceremonial torture. On occasions, captors disfigured prisoners by amputating or mutilating limbs and facial features and then set them free in order to warn or terrorize others. ²

As Egyptian and Mesopotamian civilizations began to flourish, a departure from the traditional practice of slaughtering or mutilating captives is noted in ancient writings; that is, the conquerors began to make slaves of defeated peoples. The Old Testament, for instance, contains detailed accounts of Jewish bondage in Egypt and Babylon. The practice of enslaving rather than killing prisoners, though a great step forward, cannot be ascribed to the emergence of new humanitarian concepts and ideals, but rather an economic interpretation must be given to this development. Complex, highly integrated societies such as those which rose in Mesopotamia and Egypt were made possible only by multitudes of slaves who expanded agricultural facilities, raised herds, labored in shops, rowed the boats of commerce, built the walled cities and temples, and tended the physical needs of their masters. The killing of prisoners became an uneconomical procedure in a society based on a slave economy. ³ Some of the captives taken in war became "state owned" slaves, but

SECRET

SECRET

SECRET

SECRET

the majority of them were the personal property of those who had captured them in battle or who purchased them from the captors.

In the Far East, barbaric methods of conducting warfare and handling prisoners have persisted, in some instances, to the present day. The custom of taking the heads of enemy soldiers as trophies was practiced in China and Japan until late in the nineteenth century.⁴ The Japanese held the opinion that a soldier who surrendered was dishonored and deserving of death, a traditional idea which was maintained in all strictness in Japanese military regulations published as late as January 1942.⁵ Enemies captured by the Chinese were often induced to divulge combat information by means of bribes, threats, or tortures.⁶ While a lack of respect for the lives of prisoners has characterized the behavior of most Asiatic peoples, there have been notable exceptions. The Ayrans of India believed in giving quarter to a defeated enemy who asked for mercy, and Sun Tzu, a Chinese general of about 500 B.C., taught that prisoners should be treated kindly. The latter's motivations for such conduct, however, were based on practical rather than humanitarian considerations.⁷

The early Greeks were little different from other primitive tribes in their treatment of prisoners, but as their civilization progressed it became a general practice not to refuse quarter to other Greeks who surrendered in battle. They also made a practice of ransoming important or wealthy prisoners.⁸ As a rule, however,

SECRET

-22-

SECRET

SECRET

SECRET

these humanitarian principles applied only to those of their own race; even Plato considered barbarians outside the pale of civilized obligations.⁹ Greek civilization at its height was based on a slave economy, and this, as in other early civilizations, served to temper the harshness which prisoners were made to suffer in the hands of earlier Greeks.

The early Romans were as barbaric as other primitive peoples in regard to prisoners, but as their civilization developed their practices became less harsh on the whole than those of the Greeks. The latter were shut off from imperial expansion which led factions of them to attempt assertions of supremacy frequently involving mutual slaughter. By the time the Roman Empire had been consolidated under Emperor Augustus at the beginning of the Christian era, the imperialistic policy of the Romans had resulted in a considerable advance in the treatment of prisoners with only those who had borne arms against Rome being made captives.¹⁰ As an imperialistic power, it was in Rome's interests to populate, not depopulate, her "colonies," and for the first time a real distinction began to be made between combatants and non-combatants. At home the enslavement of captives took precedence over other methods of treating prisoners. Many instances are reported of surrender terms which included cartel agreements concerning ransom rates for various classes of prisoners or of slaves being made free men or Roman soldiers.¹¹ Thus, economic

SECRET

-23-

SECRET

S E C R E T

SECRET

they perpetrated.¹⁴

The Christians of the Dark and Middle Ages excluded infidels and heretics from such humanitarian benefits as were tendered to fellow Christians just as the Greeks and Romans had excluded barbarians from treatment accorded captives of their own races. Victorious belligerents, however, persisted in the practice of enslaving captives whether or not they were Christian. A canon of the Third Lateran Council, ordered by Pope Alexander III in 1179, stated that it was unlawful to sell Christian prisoners or keep them as slaves.¹⁵ The institution of slavery, however, was so firmly entrenched in the social and economic life of the times that the admonition of this Council had little immediate effect, and the enslavement of Christian captives continued into the seventeenth century. The medieval Church was completely intolerant of heathens and heretics, and under the Theodosian code (438 A. D.) heretics could be fined, exiled, tortured, or killed, and slaves might be beaten into the orthodox faith.¹⁶ The end of the Dark Ages was characterized by the Holy Inquisition, an institution credited with some of the most unspeakable atrocities in all history.¹⁷ These excesses of religious zeal with their perversion of the true principles of Christianity had a deterring rather than a stimulating effect on the development of humanitarian concepts and, in turn, retarded

S E C R E T

SECRET

SECRET

SECRET

humanitarian advances in attitudes toward prisoners of war.

The Mussulman, for whose conversion the Christians alternately prayed and fought, set an example in the treatment of prisoners which Christians were slow to follow. As early as 805 A. D., the famous Khalif known as Harouon al Raschid concluded an agreement with another sovereign under which prisoners of war could be exchanged or ransomed.¹⁸

The period of the Renaissance and the Reformation witnessed a great variety of practices in regard to prisoners of war. An increased use of mercenary troops resulted in a limited type of warfare which was at times almost bloodless and in which the taking of prisoners was only a part of what in some ways amounted to a friendly game between gentlemen. At the other extreme there were bloody massacres such as that which took place after the Battle of Agincourt in 1415 and the terrible atrocities committed during the religious wars. The last of these, the so-called Thirty Years' War, reduced the population of some parts of Germany by half.¹⁹

The enslavement of such captives as were not killed was still general practice in England and Europe throughout the last part of the Middle Ages. A prisoner of war was considered the absolute property of his captor, and his lot was considerably worse than that of an eighteenth century plantation slave in America.²⁰ The practice of ransoming prisoners came more and more into general use

SECRET

SECRET

SECRET

SECRET

as the Middle Ages came to a close. Ransoming, in fact, became so common that it was gradually systematized, and a scale of prices for various classes of prisoners became more or less fixed by custom.²¹

Gradually the idea that all prisoners belonged to the sovereign replaced the old concept of individual ownership. During the seventeenth century, captives began to be ransomed at prices fixed by cartels at the beginning of a war or during its continuance. The last cartel of this nature seems to have been that between England and France in 1780.²² Exchange and parole slowly replaced the ransoming of captives, but combinations of exchange and ransom were practical as late as the nineteenth century. For instance, the United States and Tripoli concluded a treaty in 1805 in which the two countries agreed that prisoners should not be made slaves but exchanged rank for rank, and a monetary value for each rank was established in case of a deficiency on either side.²³

Some attempts were made to codify the conduct of hostilities during the late Middle Ages which presaged the later adoption of elaborate codes by the military establishments of various nations.²⁴ In actual practice, very few moral or legal inhibitions restricted belligerents in their conduct of hostilities throughout the Dark and Middle Ages. Enslavement of prisoners, massacres, and atrocities of all kinds were accepted as natural manifestations of war. From time to time, however, strong-minded individuals made their appearance

SECRET

SECRET

-27-

SECRET

SECRET

who did not accept current practices as right and who dared to voice humanitarian ideals concerning the conduct of warfare. With the breakdown of feudalism and the origin of nationalism, more and more thinkers attempted to analyze the phenomenon of war in the light of new relationships which were being established between individuals, between states, and between individuals and the state. New patterns of thought were translated into new practices and became the beginnings of international law on the subject of war.

By the end of the sixteenth century a considerable body of literature had been written about the problem of regularizing war. Writers speculated and philosophized on the objectives of war and on the means which could rightfully be used to achieve such ends.²⁵ Nearly all of these writers were concerned with the plight of prisoners of war and urged that more humanitarian methods be adopted in dealing with them.

One of the first systematic writers on international law was Victoria whose works, *De Bello* and *De Jure Bello* published in about 1550, were written in an attempt to evaluate the legality of warlike acts. He observed that it was illegal to do harmful acts not necessary to the attainment of the military objectives of the war and that it was illegal to injure non-combatants except where there was no other way to win.²⁶

SECRET

SECRET

SECRET

SECRET

It has become customary for writers on international law to divide historical periods by Hugo Grotius (1583-1645). This Dutch scholar is generally acclaimed as "the father of international law," and his great work, *De Jure Belli ac Pacis* published in 1625, was the first text-book to have a profound influence on the practices of sovereigns and statesmen. Grotius was the first to appeal to the law of nature as a moderating influence on the conduct of hostilities. According to him, law had its sources in the nature of man as a social being.²⁷ As a jurist, Grotius recognized the force of prevailing practice in determining the rules of warfare, and he regarded most of the current practices, including the enslavement of captives, as justified in law and ethics, provided the war was waged for a "just" cause. Though he recognized the right of enslavement, Grotius advocated exchange and ransom instead.²⁸

Under the terms of the Treaty of Westphalia (which concluded the Thirty Years' War in 1648), prisoners were released without ransom at the close of the war. This action marked the end of any extensive enslavement of captives. In the succeeding century, exchange and parole largely replaced ransom during the course of hostilities, and release without ransom at the end of a war became general practice.²⁹ A declaration of war came to be regarded as obligatory, military occupation was modified by restraining rules,

SECRET

SECRET

SECRET

SECRET

Limits were placed on ravaging, the lot of non-combatants improved, and atrocities became less frequent.

Growing concepts of humanitarianism brought about continued improvement in conditions of prisonership and in the treatment of the sick, wounded, and helpless in time of war. Beginning more or less with the time of Grotius, it became common practice for nations to conclude bilateral treaties which, in part, stipulated the treatment which would be accorded persons and property in time of war, including the disposal of ships and crews captured on the high seas. Between 1581 and 1864 at least 291 international agreements were concluded which were designed to afford the maximum protection of human life compatible with a state of war. This trend culminated in the great multilateral treaties of the late nineteenth and early twentieth centuries.

The revival of learning, widespread literacy, and the printing press made it possible for abstract thinkers like Grotius to have a direct part in bringing about changes in actual practices of war including the treatment of prisoners. Masses of men read and responded favorably to humanitarian ideas which, in turn, caused them to modify their conduct on the field of battle. While it is impossible to make a precise evaluation of the part these writer-thinkers played in ameliorating the lot of prisoners, there is no doubt that their role was a major one. A great many writers made contributions

SECRET

SECRET

SECRET

SECRET

to the cause of humanism after Grotius, but only a very few of the most influential thinkers and their ideas can be mentioned here.

Puffendorf (1632-1697), Leibnitz (1646-1716), Bynkershoek (1673-1743), and de Wolff (1679-1754) made important contributions to thought in the new field of international law. While differing in their approach to the subject and in their emphasis on the ethical basis of law, they all based their findings, as had Grotius, on a study of the actual practices of men and nations from which they attempted to generalize and systematize principles of international law.

Three writers of the eighteenth century, Charles de Montesquieu (1689-1755), Jean Jacques Rousseau (1712-1788), and Emeric de Vattel (1714-1767), are chiefly responsible for the modern view of the proper treatment of prisoners. Montesquieu and Rousseau were French political philosophers whose ideas inspired men with a new sense of the dignity of the individual. They attempted to apply the principles of natural law and reason in determining the rights and duties of the individual man in his relations with other men and with the state. They argued that individuals engaged in a war are enemies only accidentally since war is a relation between states, not between men, and that the right to kill exists only so long as defenders are bearing arms. According to Rousseau, when soldiers surrender, they cease to be enemies or instruments of the enemy state and merely become

SECRET

SECRET

SECRET

SECRET

men whose life no one has any right to take since "war gives no right which is not necessary to the gaining of its object."³⁴ To both thinkers enslavement was the same as taking a captive's life; therefore, enslavement was unlawful. According to Montesquieu, "war gives no other right over prisoners than to disable them from doing any further harm, by securing their persons."³⁵ Vattel, the Swiss diplomat and jurist, was a popular writer whose work gave currency to enlightened theories of the time. He agreed with Rousseau that the aims of war restricted a belligerent to actions necessary to attain those aims, all else being condemned as unlawful.³⁶

In expounding these views, Montesquieu, Rousseau, and Vattel virtually completed the theoretical foundation for the modern view on the subject of prisoners of war. Prisoners of the eighteenth century slowly began to benefit from mutually co-operative forces which were at work in their favor. As the ideas of humanism began to exert their influence, a corresponding modification of practices in regard to prisoners took place, and as practices became more humane, men and nations were prepared to accept more idealistic rules governing the treatment of prisoners. The eighteenth century writings of these three writers give evidence of rules and practices which were unheard of in the time of Grotius; the nineteenth century became a period of steady progress. The principles of humanity as expressed by Rousseau are by this time so firmly established that

SECRET

SECRET

-32-

SECRET

SECRET

present day authorities seldom try to justify rules relating to prisoners of war on a theoretical basis.³⁷

One of the first formal agreements between nations not at war concerning the treatment of prisoners was incorporated in the Treaty of Peace and Amity between the United States and Prussia which was concluded in 1785 and reaffirmed in another treaty of 1799.³⁸ The two powers agreed that, in the event of war, prisoners would be held under healthful conditions and would be furnished barracks and rations equivalent to those furnished the troops of the captor power. There were a number of other enlightened provisions in this treaty including a statement to the effect that war could not annul the agreements concerning prisoners since a state of war was precisely that for which such agreements were provided.

The close of the eighteenth century saw at least one other enlightened step in favor of prisoners. In 1799 the French National assembly, still under the spell of ideals of the Revolution, decreed that prisoners of war were under the safeguard of the nation and the protection of its laws. Prisoners were to be placed on the same footing as the troops of the captor power so far as rations and quarters were concerned.³⁹

The French decree and the Prussia-United States treaty were, in many ways, ahead of their time, and general principles governing

SECRET

SECRET

-33-

SECRET

SECRET

the treatment of prisoners during this period were nebulously defined and unevenly applied. Napoleon, for instance, largely ignored the French decree and his general policy was one of cruelty, yet there were many cases of the humane treatment of prisoners during the Napoleonic wars.⁴⁰ In general, however, prisoners continued to benefit from slowly improving practices during the first part of the nineteenth century. An increasing number of European powers adopted regulations for their armies to follow in dealing with prisoners of war.

Probably the first comprehensive codification of international law published by a government for use by its own armies was the so-called Lieber Code adopted by the Union Army and accepted in principle by the Confederacy during the American Civil War. Framed by Francis Lieber (1800-1872), the famous Prussian-born American publicist, this code was incorporated in a War Department general order in 1863.⁴¹ These instructions were imitated by a number of European powers, and the many treaties, conventions, and national regulations relating to prisoners which have been framed since 1863 have done little more than elaborate on the basic principles enunciated by Lieber. This code made careful distinctions as to personnel who were entitled to treatment as prisoners of war and, in much detail, prescribed humane behavior on the part of captors. Of special

SECRET
-34-

SECRET

SECRET

SECRET

interest to this study are the instructions (Article 80) regarding interrogation of prisoners:

Honorable men, when captured, will abstain from giving to the enemy information concerning their own army, and the modern law of war permits no longer the use of any violence against prisoners, in order to extort the desired information, or to punish them for having given false information.

Following the appearance of the Lieber Code, practically all of the major powers issued rules of war for the guidance of their own military establishments. These have consisted of slightly varying interpretations of existing international law and have usually included by reference the various treaties, conventions,⁴² or agreements to which each specific nation was signatory.

In 1863, the same year the Lieber Code was adopted in America, a committee of five citizens of Geneva gave first impulse to a movement which culminated in the Red Cross. The first accomplishment of the committee was the framing of a convention for the protection of sick and wounded in time of war which was agreed upon by twelve powers at Geneva in 1864.⁴³ The principle that a combatant disarmed by wounds or sickness is simply a human being in need of help was thus formalized in an international convention. The next step was to apply this principle to prisoners. The Red Cross, by its demonstrated impartiality, strict neutrality, and usefulness,

SECRET
-35-

SECRET

SECRET

SECRET

gradually won the confidence of the various nations and by 1870 was able, unofficially, to extend aid to prisoners by opening an information bureau on prisoners of war. In the international conferences of 1902, 1907, and 1912, the Red Cross won victories in securing the right to extend relief work to able-bodied prisoners and was tacitly recognized as a quasi-official agency to act as an intermediary in this work.

The growth of the Red Cross was merely one aspect of the humanitarian tendencies of the latter half of the nineteenth century. An increasing number of international meetings were held in attempts to agree on rules of land warfare. The Russian Government called a conference in 1863 which resulted in the Declaration of St. Petersburg. In 1874, an association in Paris framed a code of 146 articles based largely on the Lieber Code. The Russian Government drafted a similar code which was submitted to the Brussels Convention later that year. Another code of the same nature was framed by the Institute de Droit International at Oxford in 1880. None of the latter three codes was ratified by any power, but they had much influence upon subsequent conventions and municipal legislation. A number of the articles from these codes found their way eventually into the Geneva Convention of 1929.⁴⁴

SECRET

SECRET

-36-

SECRET

SECRET

While leaving much to be desired, the conditions under which prisoners were taken and held continued to improve. The march of humanism during the nineteenth century reached its climax with the conventions concluded at the Hague in 1899. Tsar Nicholas of Russia took the initiative in calling together delegates from twenty-five powers who concluded three conventions and issued one declaration.⁴⁵ The third of these conventions, dealing with the laws and customs of war on land, made specific provisions for the humane treatment of prisoners for the first time in a multipartite treaty. These provisions were contained in seventeen broadly conceived and vaguely worded articles which were based largely on the Brussels Convention and which embraced most of the principles of the Lieber Code.⁴⁶ Interrogation of prisoners was disposed of in one short article: "Every prisoner of war, if questioned, is bound to declare his true name and rank, and if he disregards this rule, he is liable to a curtailment of the advantages accorded to the prisoners of war of his class."⁴⁷

The inadequacy of the 1899 conventions became apparent in disputes and wars which took place at the turn of the century. In 1906, a new "Red Cross" Convention was framed and adopted by thirty-seven nations at Geneva. This convention extended and clarified the 1864 Geneva Convention and was included by reference in the Hague Convention No. IV a year later.⁴⁸

SECRET

SECRET

-37-

SECRET

SECRET

Delegates from more than forty powers met at the Hague on June 15, 1907, and on October 18th signed thirteen separate conventions, one declaration, and one final act.⁴⁹ The various conventions of 1907 improved, extended, and clarified the 1899 conventions regarding the settlement of international disputes and the conduct of hostilities. As for prisoners of war, the seventeen articles of the 1899 Convention were included, unchanged, in the Hague Convention No. IV of 1907.⁵⁰

Both the 1899 and 1907 conventions had a serious defect in that the agreed upon rules of warfare did not apply except between contracting powers, and then only if all the belligerents engaged in a war were parties to the convention.⁵¹ Entry of the non-ratifying states of Montenegro and Serbia into World War I rendered the Hague and Geneva Conventions legally inoperative among the ratifying belligerents. Despite the legal aspect of the situation, most of the belligerents considered the conventions as declaratory of international law and, as such, binding instruments.⁵²

The large number of prisoners taken during World War I created unforeseen difficulties for all belligerents when they attempted to abide by the vaguely worded rules of the Hague Convention. Violations of accepted rules occurred from time to time, and accusations of inhumane treatment from both sides led

SECRET
-38-

SECRET

SECRET

SECRET

to a revival of the practice of reprisals. The International Committee of the Red Cross was able to adjust many of these difficulties and did much to maintain respect for international law in regard to prisoners.⁵³ All belligerents created bureaus of information concerning prisoners of war and, on the whole, adhered fairly satisfactorily to the provisions of the Hague Convention No. IV.⁵⁴

The non-binding aspect of the Hague Conventions, in addition to their inadequacy in providing for contingencies arising during the war, led to a new development: treaties concerning the rules of warfare were concluded between enemy states in time of war. Various belligerents entered into such agreements through intermediary representing powers in order to reach understandings on specific points not covered by the conventions.⁵⁵

The inadequacies of existing codes had been amply demonstrated during World War I, and there was keen international interest in suggestions concerning a new convention proposed by the International Committee of the Red Cross at the Tenth International Conference in 1921.⁵⁶ In the same year, a new draft convention concerning the rules of warfare was adopted by the International Law Association in its 30th Conference at the Hague, but the draft convention prepared by the Red Cross Committee, which had been approved by the Eleventh Conference of that

SECRET
-39-

SECRET

SECRET

SECRET

organization in 1925, was the document upon which world interest centered.⁵⁷ This text was submitted to the Swiss Government which undertook the responsibility of calling together an international conference to consider the framing of a new convention regarding the treatment of prisoners of war. The resulting treaty, the Geneva Convention of 1929, will be discussed in the next chapter.

Despite the humanistic advances which have taken place in the past few centuries, nations have continued to use war as an instrument of international politics. The advances, however, are witness to the existence and growth of a moral conscience which is repelled by the idea of unrestricted violence. In some respects, World War II was a period of regression so far as humanism was concerned. It was a "total war," and distinctions between combatants and non-combatants became less marked as weapons such as the airplane and guided missiles made possible attacks on the industrial centers of an enemy. It was an ideological war with a tendency on the part of certain belligerents to revert to the old idea that members of other social groups were outside the pale of "civilized" obligations. It was a war which saw a considerable revival of the practice of enslaving captives in both Germany and the Soviet Union, and the latter was reluctant to release prisoners

SECRET

SECRET

-40-

SECRET

SECRET

at the close of hostilities. Wholesale violations of the accepted codes by one or more powers, however, cannot invalidate completely the progress that has been made in the humanizing of warfare.

SECRET

SECRET

-41-

SECRET

SECRET

CHAPTER IV

THE GENEVA (PRISONERS OF WAR)
CONVENTION OF 1929A. Summary of Certain Protective Provisions of the Convention

Early in 1925, Switzerland circulated a note asking whether the various governments would be ready to take part in a conference for the revision of the Geneva Convention of 1906 and whether they would be willing in principle to join in the framing of a code for prisoners of war. Replies to this note were, on the whole, favorable. On 1 July 1929 delegates from forty-seven nations met in Geneva to act upon two conventions which had been framed by the International Committee of the Red Cross. The convention concerning treatment of prisoners of war was signed twenty-nine days later; this code made rather than declared international law since, unlike the Hague Convention, it was to remain effective between ratifying states regardless of participation in a conflict by a non-ratifying state. The other convention entitled The Amelioration of the Condition of Wounded and Sick of Armies in the Field enlarged and extended the scope of the Geneva Convention of 1906.

The convention concerning prisoners of war consisted of ninety-seven articles listed under eight titles: I. General

SECRET

-42-

SECRET

SECRET

SECRET

Provisions, II. Capture, III. Captivity, IV. Termination of Captivity, V. Death of Prisoners of War, VI. Bureau of Relief and Information Concerning Prisoners of War, VII. Application of the Convention to Certain Classes of Civilians, VIII. Execution of the Convention.

The provisions of the Geneva Convention applied to all persons captured by the enemy who were mentioned in the regulations annexed to the Hague Convention (1907) respecting the laws and customs of war on land (Title I, articles 1-4). In these regulations, the laws, rights, and duties of war applied not only to armies but also to militia and volunteer corps fulfilling the following conditions:

1. Commanded by a person responsible for his subordinates;
2. Having a fixed distinctive emblem recognizable at a distance;
3. Carrying arms openly; and
4. Conducting operations in accordance with the laws and customs of war.

Inhabitants of a territory, as yet unoccupied, who spontaneously took up arms to resist the invading troops (levy en masse) and who had not had time to organize themselves into an "army" were to be regarded as belligerents coming under the protection of the convention if they carried arms openly and respected the laws and customs of war.

SECRET

-43-

SECRET

SECRET

SECRET

Both combatants and non-combatants constituting the armed forces of a belligerent were, in case of capture, entitled to the right to be treated as prisoners of war. The convention stipulated that its provisions would apply "to all persons belonging to the armed forces of belligerent parties captured by the enemy in the course of military operations at sea or in the air. . . ." Certain classes of civilians were, therefore, entitled to treatment as prisoners of war. These were defined in Article 81 as "individuals who follow armed forces without directly belonging thereto . . . provided they are in possession of a certificate from the military authorities of the armed forces which they were accompanying."

Articles 2, 3, and 4 specified that prisoners were in the power of the government of the captor, not of the individual or corps who had captured them. Prisoners were to be humanely treated and protected, particularly against acts of violence, insults, and public curiosity. They had the right to have their person and honor respected. Women were to be treated with all regard due to their sex. Prisoners retained their full civil status. The detaining power was bound to provide for the maintenance of prisoners, and difference in treatment accorded them was lawful only when based on military rank, state of health, professional qualification, or sex. Finally -- in a rule which was one of the most important innovations of this document -- measures of reprisal against

SECRET

SECRET

-44-

SECRET

SECRET

prisoners of war were forbidden.

The rules regarding information which a prisoner of war was required to give his captor were clear and unequivocal.

Article 5 of the Geneva Convention is quoted here in its entirety:

Every prisoner of war is bound to give, if he is questioned on the subject, his true name and rank, or else his regimental number.

If he infringes this rule, he is liable to have the advantages given to prisoners of his class curtailed.

No coercion may be used on prisoners to secure information relative to the condition of their army or country. Prisoners who refuse to answer may not be threatened, insulted, or exposed to unpleasant or disadvantageous treatment of any kind whatever.

If, because of his physical or mental condition, a prisoner is unable to identify himself, he shall be turned over to the medical corps.

All that was attempted in Article 5 was to provide safeguards for the personal dignity of a prisoner in his honorable intention to withhold information of value to the enemy. It will be noted that the framers of the convention made no unrealistic prohibitions regarding interrogation in that captors were left free to ask as many questions as they wished. Captives, in turn, were left free to answer questions if they wished, but they were granted the right to refuse to answer all questions save those concerning their name and rank or identifying number.

Article 6 was concerned with the disposal of a prisoner's immediate personal possessions. Military papers, arms, and other military equipment discovered on or with a prisoner -- articles

SECRET

SECRET

-45-

SECRET

SECRET

which are often of informational value to a captor -- could be confiscated. Gas masks, metal helmets, identification papers, insignia of rank, decorations, objects of value, and effects of personal use were to remain in the possession of the prisoner. Money could be taken from a captive only by order of an officer who was to give a receipt for the amount taken.

The scope of this study does not permit a detailed discussion of other provisions of the Geneva Convention. Generally speaking, they consisted of rules implementing and defining the general provisions of the second, third, and fourth articles. Prisoners were to be subject to the laws, regulations, and orders in force in armies of the detaining power and, as such, were liable to disciplinary punishment for acts of insubordination and disobedience. Safeguards were provided, however, to protect prisoners from unjust or excessive punishments (Articles 45 through 67). As for repatriation, it was stated in Article 75 that "repatriation of prisoners shall be effected with the least possible delay after the conclusion of peace."

The Soviet Union was not signatory to the Geneva Convention and was not, therefore, legally bound to observe its provisions. As has been noted, the force of international law is largely derived from consent, and an overwhelming majority of world powers assented to the Geneva Convention of 1929. Its provisions,

SECRET

SECRET

-46-

SECRET

SECRET

consequently, represent a standard of humane conduct against which the treatment accorded to prisoners of war by any nation, including the Soviet Union, might be evaluated.

B. Status of the Major Powers in Relation to the Geneva Convention During World War II

Attending the diplomatic conference at Geneva in 1929 were delegates from forty-seven powers. All delegates signed the document, but not all of the states which they represented deposited official instruments of ratification with the Swiss Federal Council as required by the convention. States failing to comply with this requirement could not be considered as parties to the agreement or bound to obey the rules except insofar as those rules were recognized as declaratory law. A number of states having no delegates at the conference subsequently gave written notice of their adherence to the convention, which procedure automatically made them parties to the agreement. The thirty-five states which had either ratified the convention or announced adherence as of 7 December 1941 were:

Belgium	France	Poland
Brazil	Germany	Portugal
Bolivia	Great Britain	Rumania
Bulgaria	Greece	Spain
Canada	Hungary	Sweden
Chile	India	Switzerland
China	Italy	Thailand
Columbia	Latvia	Turkey
Czechoslovakia	Mexico	Union of South Africa
Denmark	Netherlands	United States
Egypt	New Zealand	Yugoslavia 4
Estonia	Norway	

SECRET

SECRET

-47-

SECRET

SECRET

During the war, six additional nations announced their adherence to the convention: Aden, Australia, Burma, El Salvadore, Iraq, Lithuania. It will be noted that two of the major belligerents, Japan and Russia, are missing from the list of ratifying or adhering nations.

Japan sent delegates to Geneva in 1929 but never formally ratified the convention. Immediately after Japan's declaration of war against the United States and Great Britain, the International Committee of the Red Cross invited the three governments to make use of the Central Prisoners of War Agency at Geneva and urged them to declare themselves willing to apply *de facto* the provisions of the 1929 convention despite Japan's status as a non-ratifying state.⁵ The United States immediately sent a favorable reply, but Japan hesitated for two months, meanwhile agreeing to communicate desired information concerning prisoners to Geneva and announcing the opening of an information office for prisoners in Tokyo. Finally, early in February 1942 after repeated requests, the International Committee received the following statement through the Japanese Legation at Bern:

Since the Japanese Government has not ratified the Convention relative to the treatment of prisoners of war, signed at Geneva on July 27, 1929, it is therefore not bound by the said Convention. Nevertheless, in so far as possible, it intends to apply this Convention *mutatis mutandis*, to all prisoners of war who may fall into its hands, at the same time taking into consideration the customs of each nation and each race in respect of feeding and clothing of prisoners.⁶

SECRET

SECRET

-48-

SECRET

SECRET

The Legation's note added that Japan had notified the United States, the various states of the British Commonwealth, and Netherlands of her intentions in regard to prisoners. As for application of the convention to civilian internees, the Japanese, on 14 February 1942, made a similar statement, "on condition that the belligerent States do not subject Japanese internees⁷ against their will to manual labor."

In its World War II Report, the Red Cross states that negotiations with Japan "succeeded in principle, but the result proved unsatisfactory in practice."⁸ The Red Cross experienced great difficulty in securing co-operation from the Japanese Government on matters relating to prisoners, and its representatives were regarded with suspicion and hampered in their work at every turn.⁹ Evidence introduced in the Japanese War Crimes Trials after the war indicates that the military leaders of Japan consciously and deliberately ignored the Geneva Convention, particularly in regard to labor which prisoners were required to perform, though the Japanese never formally denounced the convention.¹⁰

The Soviet Union was among the powers invited by the Swiss Government to send delegates to the Diplomatic Conference at Geneva in 1929. Despite this invitation, the Soviets did not send representatives to Geneva, had no part in the framing of the document, and at no time announced adherence to the convention

SECRET

SECRET

-49-

SECRET

regarding prisoners of war.¹¹ (Both Russia and Japan had announced adherence to the "Wounded and Sick" Convention of 1929 prior to World War II.)

When Germany and her allies invaded Russia on 22 June 1941, the International Committee of the Red Cross, according to its custom, immediately notified all belligerents that it placed itself at their disposal to carry out its traditional activities and invited them to make use of the Prisoners of War Information Agency at Geneva. A few days later the committee received a telegram from Molotov, Peoples' Commissar for Foreign Affairs, indicating that the USSR would exchange information about prisoners provided that the other belligerents did the same.¹² Other favorable exchanges of communications gave rise to the hope that Russia would adopt an attitude similar to that of all other countries regarding prisoners of war.

In July 1941, the Italian Government requested, through the Red Cross, a statement from the USSR concerning the latter's attitude toward a reciprocal application of the 1929 convention. In response the Committee received a telegram, dated 8 August 1941 and signed by Vyshinski, Assistant Peoples' Commissar for Foreign Affairs, stating that Russia's policy regarding the treatment of prisoners would be as follows:

SECRET
-50-

SECRET

... The Soviet Government has already notified ... the Swedish Government, representing Soviet interests in Germany, that the Soviet Union considered binding upon itself the Rules of War which are set out in the IVth Convention of the Hague of October 18, 1907 concerning the laws and customs of war on land, subject to the obligatory condition that the above rules be observed during the war by Germany and her Allies. The Soviet Government agrees to the exchange of particulars about prisoners of war, wounded and sick, in the order provided for under Article 14 of the Annex to the above Convention, and under Article 4 of the Geneva Convention of 1929 for the relief of wounded and sick of armies in the field. Regarding your communication concerning the proposal ... to apply the other articles of the Geneva Convention of 1929, ... the Soviet Government draws your attention to the fact that all the main questions of the regime of captivity are entirely covered by the above mentioned Annex to the Hague Convention.¹³

On the assumption that the Soviet Government would observe the established customs and usages, despite the vague wording of parts of the Hague Convention, the Red Cross proceeded to set up the administrative machinery whereby prisoner lists could be exchanged and mail and parcels be sent to prisoners held in the Soviet Union. On August 20th, the Germans submitted a list of 300 names of Soviet prisoners held in Germany, but the Soviets failed to reciprocate; this first list was also to be the last. Despite repeated promises to co-operate, the Russians never submitted prisoner lists. Neither were Soviet-held prisoners permitted to exchange correspondence except in scattered instances and then not in a manner considered by German authorities as justifying reciprocal action.¹⁴

SECRET

SECRET

-51-

SECRET

SECRET

On the basis of repeated offers of co-operation from Germany and other enemies of Russia, the International Committee continued its efforts to contact Soviet authorities. Reports of these attempts to deal with the Soviets, however, almost always ended with anti-climactic negatives: "There was no reply,"¹⁵ or "The Committee never received any answer."

After August 1944, the Red Cross made no further attempt to secure Soviet co-operation. Because of Russia's attitude, Germany refused to apply the Geneva Convention in regard to Soviet prisoners. Consequently, all prisoners held by Russia and all Soviet prisoners held by Germany failed to benefit from supplies of relief goods which were made available from time to time by other powers. Mail was not exchanged, and Red Cross representatives were not permitted to visit prisoners of war camps in Russia or camps for Soviet prisoners in Germany.

In the first conference between President Roosevelt and Foreign Commissar Molotov which took place at the White House in May 1942, the President expressed a hope that arrangements might be made to exchange lists of names of prisoners of war. Molotov, having already stated that the Germans had been brutally inhumane in their treatment of Soviet prisoners, "replied with emphasis that his government was not disposed to negotiate any arrangement with the Germans which would give the latter the

SECRET
-52-

SECRET

SECRET

SECRET

slightest pretext for claiming that they (the Germans) were observing any rules whatever."¹⁶ Mr. Harry Hopkin's notes on the same interview throw further light on difficulties experienced when attempting to deal with the Soviets on matters relating to prisoners:

The State Department obviously wants Russia either to sign or adhere to the Geneva Convention of 1929 relative to the care and treatment of prisoners of war. This agreement requires that the adhering countries permit a neutral body . . . to inspect the prison camps. You don't have to know very much about Russia, or for that matter Germany, to know there isn't a snowball's chance in hell for either Russia or Germany to permit the International Red Cross really to inspect any prison camps. Molotov's final answer to that: "Why should we give the Germans the diplomatic advantage of pretending to adhere to international law. . . . You can't trust them." Molotov indicated that it would be a mistake from a propaganda point of view to give Germany the chance to say that they were the people who upheld international law. . . . I gather this is going to be a pretty difficult nut to crack for the State Department.¹⁷

The State Department never succeeded in "cracking the nut" referred to by Hopkins. At the beginning of the war Soviet authorities apparently had considered practicing limited adherence to the general body of international law concerning prisoners, but their subsequent policy of refusing to make any commitments indicates that there was a quick change of policy in this respect.

Other members of the "Big Four," the United States, Great Britain, and China, were all ratifying states of the Geneva

SECRET

SECRET

-53-

SECRET

SECRET

Convention of 1929 and, in general, treated prisoners strictly in accordance with its provisions. The convention was not observed in the conflict between China and Japan because of the latter's status as a non-ratifying state, but after 1942 the Chungking Government applied the provisions of the convention in dealing with German and Italian internees. The lack of centralized authority in China and the immense territory involved prevented an effective application of the rules in many instances.¹⁸

Germany and Italy, the major Axis powers in Europe, had ratified the Geneva Convention and, in general, applied its provisions when dealing with prisoners of war and internees except, of course, with the Russians. Many alleged violations grew out of Germany's arbitrary interpretation of rules regarding those who were to be treated as bona fide prisoners of war (for example, members of armed forces of unrecognized governments such as Free France and Poland), and the forced labor performed in Germany by prisoners was often in violation of orders from the German High Command. Such rules were in many cases enforced by the military authorities following protests by the Red Cross.¹⁹

SECRET
-54-

SECRET

SECRET

SECRET

CHAPTER V

SOVIET PRACTICES IN THE FIELD
OF INTERNATIONAL LAW

The Constitution of the USSR opens with the declaration: "Since the time of the formation of the Soviet Republics, the states of the world have been divided into two camps: the camp of capitalism and the camp of socialism."¹ It has been Soviet Russia's policy to stand alone. Obsessed by the idea of converting the world to Communism, Russia has tried since 1918 to maintain her position as a "third power," with isolationism an underlying principle of her foreign policy. Even during World War II when the Soviets were forced into an unnatural alliance with the western democracies against the Axis, the Russians persisted in regarding themselves as a state apart which eventually would have to fight her erstwhile allies.² They made stringent efforts to prevent their allies from learning any more than was absolutely necessary about the Soviet Union and its armed forces while maintaining an elaborate espionage program in the countries of their allies. During and after the war the Soviets conducted endless interrogations of prisoners of war who knew anything about the western democracies in order to collect all possible types of information -- military, technical,

SECRET
-55-

SECRET

SECRET

SECRET

economic -- about these countries. 1

At the beginning of the Communist regime, the Soviets loudly declared their denunciation of all treaties inherited from Tsarism and the Kerensky Government. This did not prevent them from demanding the execution of such agreements when it suited their convenience. 3 Despite their desire to remain isolated, it was nevertheless necessary for the Soviets to enter into treaties with other states, but in pursuing their policy of isolationism they showed a marked preference for bi-lateral treaties and individual agreements rather than multi-lateral treaties. Entering into treaties and agreements with capitalistic states on a large scale took place only after a fierce inner struggle in the Communist Party (1924-25) which left Stalin in the ascendancy with his thesis of "socialism in a single country." Formerly, the theory that a proletarian state could exist in a capitalistic environment had been rejected by Soviet theorists as "un-Marxian and utterly utopian." 4

Thus rationalizing their ideological differences with the "capitalistic" states, the Soviets became increasingly active in the diplomatic world. The moral basis for Soviet conceptions of international law, however, are based on the Communist's faith in the righteousness of the class struggle, and this faith permits no humanitarian or chivalrous limitations. In 1921, Lenin wrote:

SECRET

-56-

SECRET

SECRET

SECRET

"The object of the party is to exploit all and any conflicting interests among the surrounding capitalist groups and governments with a view to the disintegration of capitalism." 5 Stalin echoed Lenin's ideas in a speech three years later: "Contradiction, conflicts, and wars among the bourgeois states hostile to the proletarian state are the reserves of the revolution." 6 The indoctrination program which the Soviets conducted in prisoner of war camps during and after World War II was a part of their continuing attempt to foment revolution in other countries and to hasten "the disintegration of capitalism."

While Soviet diplomats concluded their pacts with various countries, the Moscow-directed Third International pursued its task of fostering revolution in those same countries, although the latter was kept somewhat in check after 1928 in order to permit Soviet diplomacy more flexibility in its maneuvers. 7 Thus, practical considerations and political necessity led the Soviets into international agreements and alliances, but opportunism has at all times outweighed any theories concerning moral obligations to fulfill treaties. 8 The Soviets entered into peaceful relations with other states without relinquishing the Marxist-Leninist-Stalinist doctrine that the "socialist" state, which Communists faithfully believe will envelope the earth, can be established only by force and violence, by war and

SECRET

-57-

SECRET

SECRET

SECRET

revolution, and by savage reprisals against all dissenters. The first *de jure* recognitions of the Soviet Government began in February 1924 with recognition by Great Britain.⁹ As early as April 1922, the Treaty of Rappallo had been signed with the German Weimar Republic, a triumph for the Soviet diplomatic corps and one which enabled them to play on the dissensions between Germany and her former enemies throughout the next decade. As European states, hesitatingly, began to acknowledge the Soviet regime, a wide network of non-aggression, non-intervention, and neutrality pacts was fabricated by the Soviets with many countries.¹⁰ Throughout the 1930's and until Hitler had destroyed the Communist Party in Germany and secured complete control of the Third Reich in 1934, Communist thought in Russia had clung to the hope that Germany would be the scene of the next Communist revolution, and it was with difficulty that Soviet leaders relinquished this idea. After 1934, a rapid reorientation began and the new diplomatic policy included pacts, particularly with France, designed to protect Russia from the growing Nazi menace.¹¹

Among international agreements regarding warfare entered into by the Soviet Union were the Covenant of the League of Nations, the Washington treaties of 1922, the Geneva Protocol of 1924, the Locarno Treaty of 1925, the Briand-Kellogg Pact of 1928, the Hague Conventions of 1907 on Hospital Ships and on the Rights and Duties

SECRET

SECRET

SECRET

SECRET

of Neutral Powers in Naval Warfare, and the Geneva Conventions of 1906 and 1929 for the Amelioration of the Condition of the Wounded and Sick of Armies in the Field.¹²

In the summer of 1918, very early in the Communist regime, the Soviet Government passed a decree by which it acceded to all international Red Cross conventions. Almost at the same time, another decree was passed by which the government took over the Russian Society of the Red Cross and made it an official organization. Article 1 of the latter decree reads: "The Russian Society of the Red Cross is acting on the basis of the Geneva Convention of 1864 and conventions subsequent thereto."¹³ The Soviets professed to attach considerable importance to the work of the Red Cross because, according to a Communist spokesman, the most valuable human material was found not only among the soldiers of the USSR but also among the soldiers of the enemy. Since the latter were mostly proletarians and, therefore, "eventual allies of the Workers and Peasants Republic," the preservation of their lives and health were considered by the Soviets to be of primary importance.¹⁴

Acceding to treaties of a humanitarian or social nature and co-operating with other nations in the preservation of human life and health has been in striking contrast to the Soviet policy of refraining from participating in agreements bearing on social

SECRET

SECRET

-59-

SECRET

SECRET

problems having political significance. ¹⁵ For Soviet Russia, the taking of prisoners has both economic and political implications -- they can be used to perform labor and they can be indoctrinated and taught how to further the Communist mission in their native countries after repatriation. The failure to accede to the Geneva Convention of 1929 regarding prisoners and the renunciation in practice of the Hague Convention of 1907 were perfectly consistent with Soviet foreign policy regarding commitments of a political nature.

As noted previously in this study, the Red Cross drafted a new code for prisoners of war in 1921 which was forwarded for comment and criticism to all states party to the Red Cross Conventions. The Russian Red Cross, with official sanction, proceeded to draft a counter-project which consisted, in the English translation, of less than five hundred words. This proposal was conservative in nature, and in no essential respect did it conflict with the Hague rules of 1907 or with the Geneva Convention of 1929. There was, however, at least one noticeable omission in the counter-proposal. In the Hague and Geneva documents customary distinctions between officers and enlisted men were recognized, but the Soviets ignored such distinctions in their document, the term "war prisoners" being used exclusively.

SECRET

SECRET

-60-

SECRET

SECRET

Treaties of peace with the Soviet Union concluded with neighboring countries from 1920 to 1924 included many provisions for the disposition of prisoners. The lack of distinction between officers and enlisted men is a noticeable aspect of these treaties. Wars between the infant Soviet Union and her neighbors had been "class" as well as political conflicts, and in the treaties numerous provisions were made for the exchange or repatriation of civilian prisoners and hostages who had been detained for political or ideological rather than military reasons. In only one of the documents, the Hungarian Agreement of July 1921, were distinctions made between officer and enlisted prisoners.¹⁷

Prior to World War II, the only concrete indications of the Communist attitude toward prisoners of war were contained in the Russian Red Cross draft proposal and the few treaties discussed in the foregoing paragraphs. Upon analyzing these documents, it would seem that the Soviets agreed with the bourgeois statesmen on the principle that war is a relation between states and not between individuals. This concept is the foundation upon which many of the principles concerning humane treatment of prisoners have been founded. For Communists, however, war is always a contest between classes, and the individuality of the person is always merged in his class. Since officers in the armies of "capitalistic" states are generally drawn from social classes which the Communists

SECRET

SECRET

-61-

SECRET

SECRET

consider incorrigible enemies of the proletariat and since the Russians had attempted to ignore customary distinctions between officers and enlisted men in their own army throughout the first two decades of the Red Regime, at least some observers during the 1930's predicted that the Soviets would discriminate sharply between officers and enlisted prisoners in the event of a major conflict. ¹⁸ During World War II, however, the "officer class" of the Red Army largely discarded the "comradely" practices of the 1930's and adopted more traditional relationships between military commanders and subordinates. Possibly because of this the Russians did make some of the customary distinctions between officers and enlisted men in their treatment of prisoners during World War II.

The first interrogations to which prisoners of the Red Army were subjected during World War II were primarily for the purpose of gaining tactical and strategic information, but even in these first questionings, Soviet preoccupation with the political aspect of the war became evident. An immediate attempt was made to discover incorrigible "class enemies" so that they could be eliminated or given discriminatory treatment in labor camps. Such discrimination was not necessarily drawn along officer-enlisted lines. All prisoners were carefully screened to discover those of proletarian origin, and those who seemed disposed to accept Soviet ideas were

SECRET

SECRET

-62-

SECRET

SECRET

often given favored treatment. In some cases an immediate attempt was made to recruit agents from among this latter group. Practically all prisoners were subjected to an intensive political "re-education" program in an effort to convert them to Communism.

While Germany and the Soviet Union engaged in many diplomatic negotiations preceding World War II, most of these were for the purpose of concluding trade agreements. A careful search through the captured records of the German Foreign Ministry has failed to reveal any negotiations between the two powers concerning rules of warfare or the treatment of prisoners. Nor is there any known record, beyond the few documents cited, of Russia having acceded to such agreements with any other country prior to World War II. Russia's refusal to adhere to the Hague and Geneva Conventions during World War II was discussed in Chapter IV of this study. The Soviet Union did, however, participate in the framing of the Geneva (Prisoners of War) Convention of 12 August 1949, a document which the Soviet delegates to the diplomatic conference signed with certain reservations. ¹⁹

In the great conflict between Germany and Russia where neither side pretended to observe international law regarding prisoners, millions of captives suffered great hardships and a large percentage of them died. Such benefits as accrued to the surviving prisoners of both powers can be said to have arisen more

SECRET

SECRET

-65-

SECRET SECRET

from the self-interest of the captors than from humanitarian considerations -- as in primitive times when enslavement took precedence over the slaughter of captives. Both nations needed manpower to carry on the war. Captives were therefore put to work under slave conditions. Slaves, however, are valuable only when they are healthy and strong, so those captives needed for labor were given correspondingly better treatment. With an eye to political domination in the future, both the Nazis and the Communists pampered selected groups of prisoners while training them for political and espionage missions in their native countries. It would seem that neither the Soviets nor the Nazis were influenced to any noticeable degree by purely humanitarian considerations in any of the actions they took relative to the amelioration of the lot of prisoners who fell into their hands.

Communist ethics permit of any means to justify an end, and the Soviets have few if any inhibitions based on respect for the individual which affect the behavior of both individuals and states among the democracies. For purposes of deception and propaganda, however, the Russians have usually attempted to clothe their activities with the respectable habiliments of democratic legal processes, and cruel or inhumane practices have been kept as secret as possible. These characteristics of Soviet procedure have been particularly noticeable in relation to their utilization

SECRET SECRET

SECRET SECRET

and treatment of prisoners of war.

Millions of prisoners were retained in Russia for years after the close of hostilities. The Soviets baldly admitted that they were being retained to work off reparation debts, but other powers eventually brought enough pressure to bear so that they finally agreed to begin the repatriation process. At this time, however, the Soviet list of punishable war crimes was extended to include offenses so petty as to be absurd, and thousands of prisoners were interrogated either in an attempt to make them admit to crimes or to force them to reveal the names of guilty parties. Accused "war criminals" were then tried, found guilty on the flimsiest of evidence, and sentenced to long terms of hard labor. This was a typical device employed by the Soviets to stay within the letter of international law regarding repatriation and yet to delay the return of prisoners to their homes, thus securing a huge supply of expendable slave labor as well as preventing the return to their native lands of certain anti-Soviet elements among the prisoners.

So-called "political interrogations" have long been conducted in Russia for the purpose of discovering dissident elements and of eliminating opposition to the regime. Political prisoners, either suspected opponents of the regime in Russia and its satellites or

SECRET SECRET

SECRET

SECRET

prominent enemy personalities, have been subjected to an inquisitorial type of interrogation designed to break their resistance, mentally and physically, and to force them to profess a changed point of view in keeping with Soviet ideology. "Confessions" have been secured by means of these interrogations which have been used to further the political ambitions of power-hungry Soviet leaders and which have added fuel to the Soviet propaganda machine. Because of the rigid censorship prevailing behind the "iron curtain," propaganda based on these confessions is probably more effective than is realized in the democracies. A by-product of this type of interrogation may have been some useful counterintelligence information, but such procedures are of little value in the formulation of reliable combat and strategic intelligence.

A dictatorship such as exists in the Soviet Union can maintain its power only by putting reliance on intelligence agencies which ferret out and destroy all opposition. Every member of the Communist Party in Russia is, in a sense, a secret informant, on the lookout for both domestic and foreign enemies. In order to maintain the security of the regime, various intelligence agencies with overlapping functions maintain one of the most far-reaching surveillance programs the world has ever known. The system is so elaborate that there is at least one secret informer for every

SECRET

SECRET

-66-

SECRET

SECRET

ten to twenty Soviet citizens and for every five to ten soldiers in the Red Army. Mere lack of enthusiasm is enough to arouse suspicion. The slow worker is a possible saboteur. Informers who fail to discover disaffection are themselves suspect. Unfounded denunciation by an enemy or a rival will cause the arrest of the accused. In conducting this program of surveillance, the Soviets have placed great reliance on the effectiveness of interrogating suspects. Interrogation as practiced in the Soviet Union thus becomes not only a means of gaining information but also a "weapon" employed by the regime to inspire fear and to suppress opposition. Millions of Soviet citizens have therefore undergone questioning by secret service operatives. As a result, the "art" of interrogation has reached a high state of development in Russia, and the various intelligence agencies have a large pool of highly trained, experienced interrogators. Significantly, during World War II, the interrogation of prisoners of war was largely turned over to the Peoples' Commissariat of the Interior (NKVD), the principal domestic counterintelligence agency, rather than to a military intelligence agency.

The national character of the people of the USSR, the effect of Communism on that character, and the nature of the ideological war between Russia and Germany all had their effect on the manner

SECRET

SECRET

-67-

SECRET SECRET

in which the war was fought, on the treatment of captives, and on methods of interrogation. The scope of this study does not permit an extended discussion of these factors; neither does an objective study of this kind permit of subjective interpretations of cause and effect. In the following chapters of this study, however, it will sometimes be necessary to take some of these general factors into consideration when analyzing Soviet methods. For instance, it was frequently noted that Russian guards, when acting singly, would perform secret acts of kindness for prisoners but that the same guards would be strict if not actually brutal when their superiors or fellow guards were present. To a certain extent such behavior could be attributed to national characteristics of Russian temperament, but it was not necessarily an indication of "split-personality" on the part of the guards. More likely, it was a manifestation of the Soviet surveillance system which made it impossible for guards to trust their closest friends, any one of whom might have been an informer. Despite the system of surveillance, Soviet authorities found it necessary to rotate prison-camp guards, sometimes daily, because of the tendency of some guards to make friends with the prisoners. These are but minor examples of how "methods" were affected by national character and by the nature of the Soviet regime.

SECRET SECRET

PRISONER EVACUATION: SOVIET ARMED FORCES. WORLD WAR II

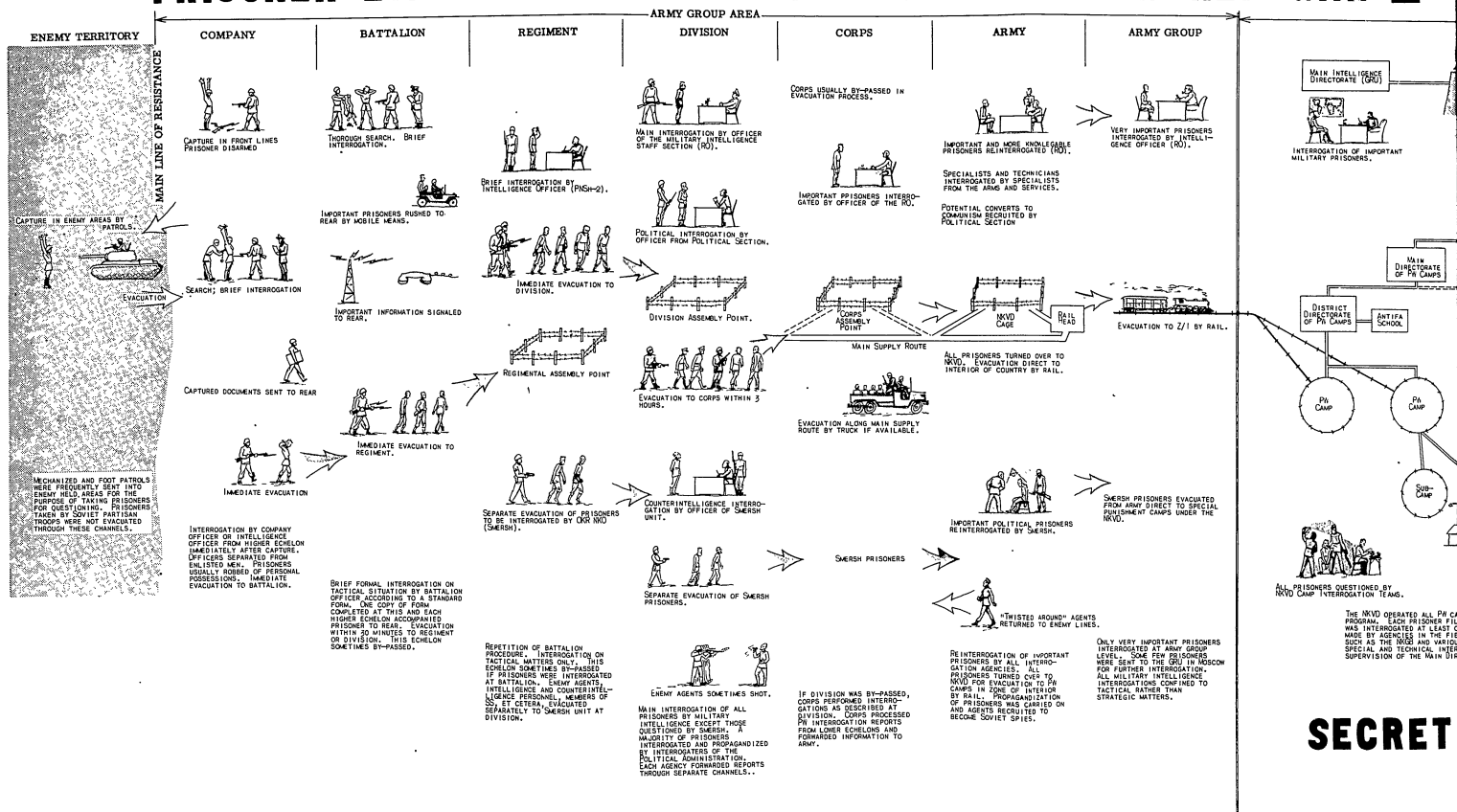

SECRET

EVACUATION: SOVIET ARMED FORCES. WORLD WAR II

Figure 1.

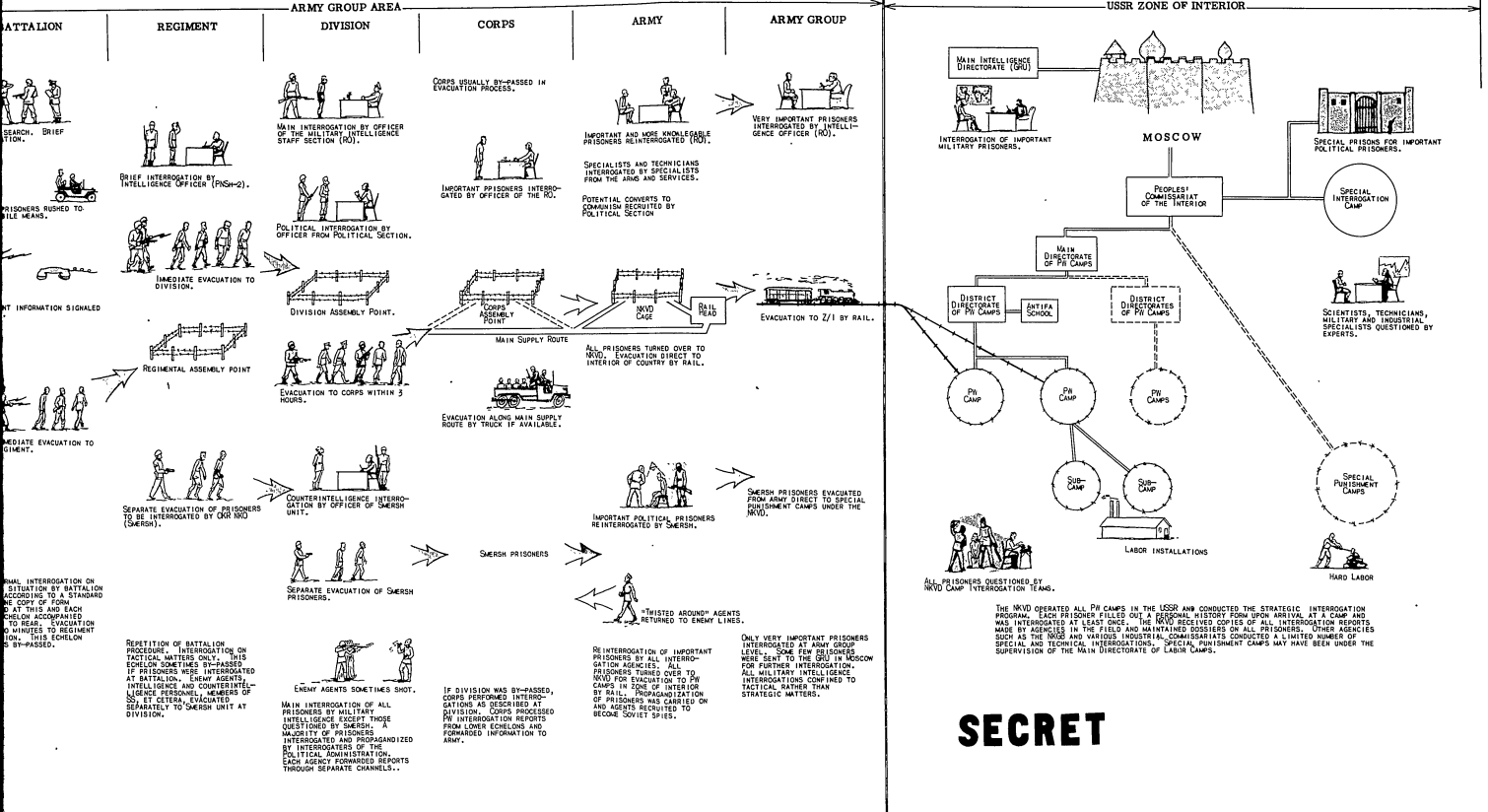

S E C R E T

SECRET

PART TWO

CHAPTER VI

NATIONAL DEFENSE SYSTEM
OF THE USSR

A. General

The Soviet Union is a totalitarian state, and the various political, economic, and military systems of such a state are so closely integrated that no one agency can be discussed without reference to the whole governmental structure. In less centralized systems of government the handling of prisoners of war, for instance, takes place almost entirely within the framework of the military organization -- but not in the Soviet Union. Therefore, in order to describe Soviet methods of interrogation and the way in which information secured from prisoners is exploited, it becomes necessary to precede the actual discussion of interrogation methods with an explanation of the governmental structure of the Soviet Union, of the relation of the Communist Party to the government, and of the organization of the armed forces. This will be followed by a more detailed description of the various military and para-military agencies directly responsible for the interrogation of prisoners and for the evaluation and utilization of information secured from prisoners.

S E C R E T

SECRET

SECRET SECRET

The Government of the USSR is an exceedingly complex structure, which underwent many changes during the war when it was necessary to adapt the organization to meet the emergencies imposed by the German invasion. Since the war more changes have taken place, particularly in the higher echelons of the armed forces and of the various security agencies. The scope of this study permits only a brief treatment of the Soviet governmental, military, and intelligence organization. For the military student, much information is available in the various manuals, documents, and other publications upon which the following discussion is based.

B. Government of the USSR and the Communist Party

In 1924, the Union of Soviet Socialist Republics was established as a federation of the four Republics which then made up the Soviet Union. By 1941, this number had been increased to sixteen. The Union Government (in Moscow) had enumerated and delegated powers while the constituent members had residual powers according to a constitution. Some of the larger republics (SSR) were subdivided into various types of administrative areas of which twenty were known as Autonomous Soviet Socialist Republics (ASSR), nine as Autonomous Provinces (Oblasts), and ten as National Regions (Okruzs).

Under the 1936 constitution, the highest legislative powers of the Soviet Union were vested in the Supreme Soviet an elected,

SECRET SECRET

SECRET

Figure 2.

STATE ADMINISTRATIVE STRUCTURE USSR (1945)

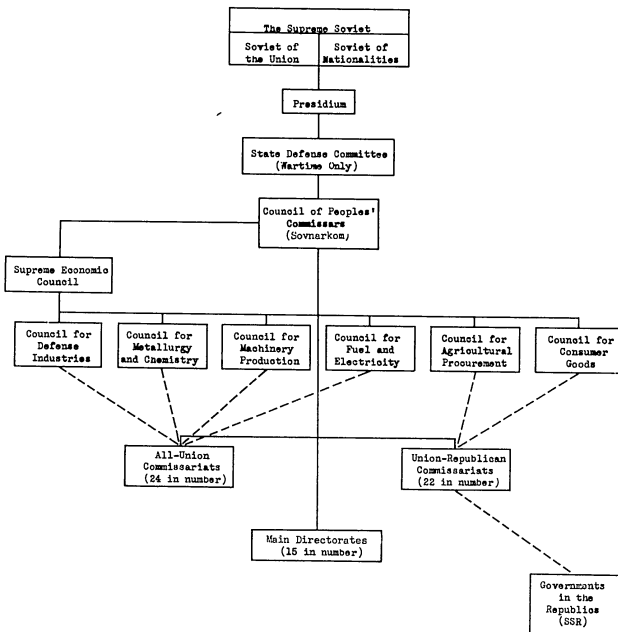

Reference: WD TM 30-430
Chapter I, p. 6.

Legend.
— Command Channel
- - - Coordination Channel

SECRET

SECRET SECRET

representative body consisting of two chambers. (See Figure 2). In one chamber, The Soviet of the Union, each member was elected from a district with a population of 300,000. In 1941 these members totaled 647. The other chamber, The Soviet of Nationalities, had 713 members elected on the basis of 25 from each republic, eleven from each autonomous republic, five from each autonomous province, and one from each national region.¹

The Supreme Soviet normally met for a brief session twice yearly and in a joint session elected a Presidium of from 36 to 42 members which constituted a kind of collective presidency of the Soviet Union. To this Presidium was delegated the powers of the Supreme Soviet between sessions of the latter body. The Supreme Soviet (or the Presidium) also appointed the commissars of the various All-Union and Union-Republican Commissariats which collectively formed the Council of Peoples' Commissars (Sovnarkom). This council was responsible only to the Supreme Soviet, or, in the long periods between sessions, to the Presidium.

The structure of the federal or union government as outlined above was paralleled in each of the republics by a similar organization. These republican governments, however, lacked certain of the commissariats. At the federal level only were twenty-four All-Union commissariats dealing with matters such as transportation, communication, and heavy industries; in addition at the federal

SECRET SECRET

SECRET SECRET

level were twenty-two Union Republican commissariats dealing with light industry, agriculture, justice, health and other matters which, theoretically at least, worked with and through corresponding commissariats in the governments of the republics.

The number of commissariats and their designation as All-Union or Union-Republican agencies has varied from time to time. Of particular importance to this study are the Commissariats of Defense (NKO), of State Security (NKGB), and of Internal Affairs (NKVD), each of which had counterparts in the republican governments, and each of which had some part in the handling of prisoners of war.

The administrative machinery of the federal government included, in addition to the 46 commissariats, approximately fifteen so-called Main Directorates (Glavni Upravleniya) and committees of commissariat level of importance. For more efficient operation, the powers of this unwieldy body of commissariats and main directorates were delegated to a smaller number of councils or committees, especially to the Supreme Economic Council and its subordinate organizations for the defense industries. Thus, the councils superseded or "out-ranked" the commissariats in importance and authority. (See Figure 2). During World War II, a State Defense Committee was formed which was the supreme operation committee and which co-ordinated and directed the activities of

SECRET SECRET

SECRET SECRET

the entire body of commissariats, main directorates, and councils.

The judicial branch of the Soviet Government was headed by the Supreme Court which supervised all courts in the USSR. The Supreme Court and the All-Union court system was staffed by appointees of the Supreme Soviet (or the Presidium). A branch of the Supreme Court, the Military Collegium, was charged with the administration of justice within the armed forces and supervised all military courts through the Chief Procurator of the Commissariat of Defense.

The facade of democratic government as pictured in the foregoing discussion was only the front for a stern dictatorship. Stalin and a small clique of high-ranking Communists had absolute and final authority in Russia through their control of the Communist Party. This organization has never included more than five percent of the population of the Soviet Union; during most of its rise to power, the Party had less than a million members. The dictatorship was made possible by the unique place held by the Communist Party in the Soviet Government; in a very real sense it was the Government of the USSR. As the only legal party in the Soviet Union, it alone could nominate candidates for government posts, and voters had but one choice on the ballots in an election. As a result, 81 percent in the Soviet of the Union and 71 percent in the Soviet of Nationalities were party members or candidates for membership

SECRET SECRET

SECRET

SECRET

in the 1941 Supreme Soviet, and the remainder were approved by local Communist "cells" or committees.³ Party members held all important executive positions down to the lowest echelons of local government. Power was further concentrated by giving one key individual a number of correlated positions. Thus, Stalin combined in his person the positions of Secretary General of the Communist Party, Chairman of the Council of Peoples' Commissars, Commissar of Defense, and Commander-in-Chief of the Armed Forces, to name but a few of his titles.

Internally, the Communist Party was still another government within a government. Its top-ranking members, who held all key government positions, were also members of the Central Committee of the Communist Party. This Central Committee was the real Soviet Government, and all important policy was determined by its members. The Committee's power was based on the network of semisecret cells that controlled and dominated every part and organization of the Soviet Union; the Committee maintained its own system of communications and exercised direct control over the semi-military security organizations (the Commissariats of State Security and of Internal Affairs). The Main Political Directorate of the Red Army checked on the loyalty, training, and morale status of the armed forces and reported directly to the Central Committee. Party discipline was strict, and deviation

SECRET

SECRET

SECRET

SECRET

from party policy was severely punished by expulsion, imprisonment, or death.

Externally, the Communist Party attempted to represent itself as an elite group that directed the state by moral force alone. Every possible device was used to insure maximum political, social, and economic prestige for the Party. Every national achievement was credited to the Party, and all prominent individuals were solicited for membership. The Party reserved the sole right to criticize inefficiency or political errors and would not tolerate criticism of or deviation from authorized doctrine and policy.

Though party membership has been kept small, additional influence has been exercised through the large number of candidates for membership and through various organizations which have enlisted practically all the youth in the USSR down to the lowest age groups: the Komsomols (League of Communist Youth), the Pioneers, and the Octobrists. From these propaganda-saturated organizations a small number of the more able and fanatically loyal individuals have been recruited for membership in the Communist Party.

C. Soviet Military and Para-Military Forces

1. The Supreme Command

During World War II, the central government of the

SECRET

SECRET

SECRET SECRET

Soviet Union provided for and enforced the closest co-operation between the armed forces, their control agencies, and all civil economy agencies. The armed forces consisted of the Red Army, the Red Navy, and the air components of each of these services; semi-military forces consisted of the troops of the Peoples' Commissariat of Internal Affairs (NKVD). Practically all of the civil economy branches of the government were also militarized during the war, including the Peoples' Commissariats of Transportation, Maritime Fleet, River Transport, and Signal Communications, and the Main Directorates of the Civil Air Fleet and the Northern Sea Route. Activities of these latter agencies extended into the zone of operations, and their uniformed personnel were subject to military law and discipline but remained under the direct control of their respective organizations. None of the Soviet armed forces or para-military forces was a special instrument (that is, officially) of the Communist Party. Between the troops of the Commissariat of Internal Affairs (NKVD) and the troops of the Commissariat of Defense (NKO) existed an exact division of responsibility, established and zealously maintained by the Communist Party.

A distinct division existed between the command and the administrative channels and agencies in the Red Army and the Red Navy. Components of the high command of the armed forces included

SECRET SECRET

SECRET SECRET

all agencies in the chain of operational command: the State Defense Committee (the supreme governmental body during the war), the Supreme Commander of Armed Forces and his Supreme Military Council, the Chief of the General Staff of the Red Army, the Supreme Naval Council, the Commissariat of the Navy, and the Naval Staff. Army command extended from the Supreme Military Council through the Chief of the General Staff to army groups and other field forces. Naval command also extended from the Supreme Military Council through the Supreme Naval Council, the Commissariat of the Navy, and the Naval Staff to active naval units. The four commissariats of the armed forces (Defense, Navy, Internal Affairs, and State Security) maintained administrative and technical control but were subordinate to the Supreme Military Council in matters of policy.

The State Defense Committee (see Figures 2 and 3) was the supreme governmental body during World War II. Created on 1 July 1941, it was dissolved in September 1945. The eight members of this committee were also members of the Council of Peoples' Commissars and of the Politburo; Stalin was chairman, and the membership included such top personalities as Bulganin, Molotov, Beria, and Malenkov. The Committee's directives on major issues by-passed the administrative machinery of the military commissariats and went directly to the Supreme Military Council.

SECRET SECRET

SECRET SECRET

Soviet Union provided for and enforced the closest co-operation between the armed forces, their control agencies, and all civil economy agencies. The armed forces consisted of the Red Army, the Red Navy, and the air components of each of these services; semi-military forces consisted of the troops of the Peoples' Commissariat of Internal Affairs (NKVD). Practically all of the civil economy branches of the government were also militarized during the war, including the Peoples' Commissariats of Transportation, Maritime Fleet, River Transport, and Signal Communications, and the Main Directorates of the Civil Air Fleet and the Northern Sea Route. Activities of these latter agencies extended into the zone of operations, and their uniformed personnel were subject to military law and discipline but remained under the direct control of their respective organizations. None of the Soviet armed forces or para-military forces was a special instrument (that is, officially) of the Communist Party. Between the troops of the Commissariat of Internal Affairs (NKVD) and the troops of the Commissariat of Defense (NKO) existed an exact division of responsibility, established and zealously maintained by the Communist Party.

A distinct division existed between the command and the administrative channels and agencies in the Red Army and the Red Navy. Components of the high command of the armed forces included

SECRET SECRET

SECRET SECRET

all agencies in the chain of operational command: the State Defense Committee (the supreme governmental body during the war), the Supreme Commander of Armed Forces and his Supreme Military Council, the Chief of the General Staff of the Red Army, the Supreme Naval Council, the Commissariat of the Navy, and the Naval Staff. Army command extended from the Supreme Military Council through the Chief of the General Staff to army groups and other field forces. Naval command also extended from the Supreme Military Council through the Supreme Naval Council, the Commissariat of the Navy, and the Naval Staff to active naval units. The four commissariats of the armed forces (Defense, Navy, Internal Affairs, and State Security) maintained administrative and technical control but were subordinate to the Supreme Military Council in matters of policy.

The State Defense Committee (see Figures 2 and 3) was the supreme governmental body during World War II. Created on 1 July 1941, it was dissolved in September 1945. The eight members of this committee were also members of the Council of Peoples' Commissars and of the Politburo; Stalin was chairman, and the membership included such top personalities as Bulganin, Molotov, Beriya, and Malenkov. The Committee's directives on major issues by-passed the administrative machinery of the military commissariats and went directly to the Supreme Military Council.

SECRET SECRET

SECRET SECRET

The Supreme Military Council, also with Stalin at the head, consisted of twelve to fourteen top military leaders selected so as to represent the chief branches of the arms and services. It translated policy decisions of the State Defense Committee into military action by its directives to the General Staff and respective headquarters of the various arms and services. The General Staff and main directorates of the various arms and services were working staffs of the Supreme Military Council.

The Chief of Staff commanded all divisions of the General Staff and was responsible for the preparation of operational plans and for reconnaissance operations.

The General Staff of the Red Army was the highest advisory body to the Chief of Staff and Supreme Military Council. In co-operation with the staffs of the arms and rear services, it was responsible for insuring co-ordination between arms and services at all levels. The four principal directorates of the General Staff that had counterparts in the staffs of lower headquarters were the Operations, Intelligence, Signal, and Topographic Directorates. Three directorates which were peculiar to the General Staff alone were the Formations (statistical control and organizational policy), the Fortified Areas, and the Historical Directorates.

The First (Operations) Directorate was a plans and training

SECRET SECRET

-78-

SECRET SECRET

section corresponding generally to the G-3 of the United States Army.

Of primary interest to this study is the Second (Intelligence) Directorate (GRU) of the General Staff which corresponded to the American G-2. It was the highest agency for the collection and evaluation of positive information about the enemy. The Second Directorate was also responsible for reconnaissance plans and could prepare direct orders for execution of these plans in the field. Prisoner-of-war information and captured documents were sent to this Directorate for final exploitation. Other agencies and staff divisions co-operated with the Second Directorate in matters such as signal intelligence, the employment of secret agents, and topographic intelligence. Counterintelligence was handled by the Main Directorate for Counterintelligence in the Commissariat of Defense and by the Commissariats of State Security (NKGB), and Internal Affairs (NKVD).

The Peoples' Commissariat of Defense (Figure 3) was subordinate to the State Defense Committee during the war. Before that it had been subordinate only to the Council of Peoples' Commissars. The Commissar (Stalin), the First Deputy (Zhukov), and at least ten other deputy commissars, all holding the rank of Lieutenant General or higher, made up the membership of this Commissariat. The Supreme Military Council gave directions

-79-

SECRET

SECRET

SECRET SECRET

to the Commissariat in affairs relating to the prosecution of the war while the General Staff also exercised much direct control over the Commissariat. Since the same personnel served in all three of these bodies in many cases (eight of the twelve members of the Commissariat also served on the General Staff), command superiority of one agency over another at this level was more an academic than a real distinction. Directly subordinate to the Commissariat of Defense were the Inspectorate of Infantry, the Affairs Administration (regulations, publication, foreign liaison, and other sections), and eighteen main Directorates for arms and services, and other activities. Of primary interest to this study is the fact that this Commissariat was charged with the promulgation of basic regulations and administrative policies of the Red Army; with the responsibility for the academies and schools which trained officers and military specialists; and with the publication of official journals or bulletins for the arms and services which carried the power of directives.

Top-level organization of the U.S.S.R. Armed Forces as presented in the foregoing discussion was the wartime organization only. Soon after World War II a number of important changes took place: the State Defense Committee was dissolved in September 1945; the Commissariat of Defense (NKO) and the Commissariat of the Navy (NKVMF) were combined in the Ministry

-80-

SECRET SECRET

SECRET SECRET

of the Armed Forces (MVS); the Commissariat of Internal Affairs (NKVD) became the Ministry of the Interior (MVD), and the Commissariat of State Security (NKGB) became the Ministry of State Security (MGB). All three ministries were subordinate to the Council of Ministers. Since all of these agencies were directly concerned with the handling of prisoners both during and after the war, they will be referred to in this study by the title they held at the time the particular matter or event that is under discussion took place.

2. Field Organizations of the Red Army

Prior to the war with Germany, the Military District was the highest active field organization in the Red Army. (The Finnish War, for instance, was conducted by the Leningrad Military District.) The Soviet Union was divided into approximately thirty military districts, each directed by a commander and a military council and each capable of raising and training an infantry army in the first echelon of mobilization. The highest tactical organization in the military district was the corps, consisting of three or four rifle divisions and supporting arms and services totaling sixty to sixty-five thousand men. Cavalry and motor-mechanized corps were considerably smaller.

The war with Finland revealed to the Soviets that their organization of higher tactical units was unwieldy, and the reorganization of the entire structure of the field forces that began

-81-

SECRET SECRET

SECRET SECRET

in the spring of 1941 was continued and hastened by the German onslaught in the summer of that year. The subsequent organizational structure of the Red Army field forces as it became stabilized by the winter of 1943-44 is briefly described in the following discussion.

Army Groups, or Fronts, superseded the military districts as the main planning and administrative agencies under the Supreme Command. Military Districts were maintained only in the rear areas. The size of a front sector was determined by lines of communication since the relative scarcity of good roads and railroads in Russia to a large extent determined tactical capabilities. A Red Army Front corresponded roughly to a Theater of Operations in U.S. Army terminology. In 1943, there were 17 fronts, but the number had been reduced to seven at the close of the war with Japan.

The Army Group or Front consisted of approximately a million men commanded by a marshal who was assisted by a military council, comparable to the Supreme Military Council, directorates for arms and services and other activities, and a staff similar to the General Staff, but lacking the Formations, Fortified Areas, and Historical Directorates peculiar to the latter. In short, front headquarters was a scaled duplicate of the Supreme Military Council and Commissariat of Defense.

-82-
SECRET SECRET

SECRET

Command and Administration of the Red Army

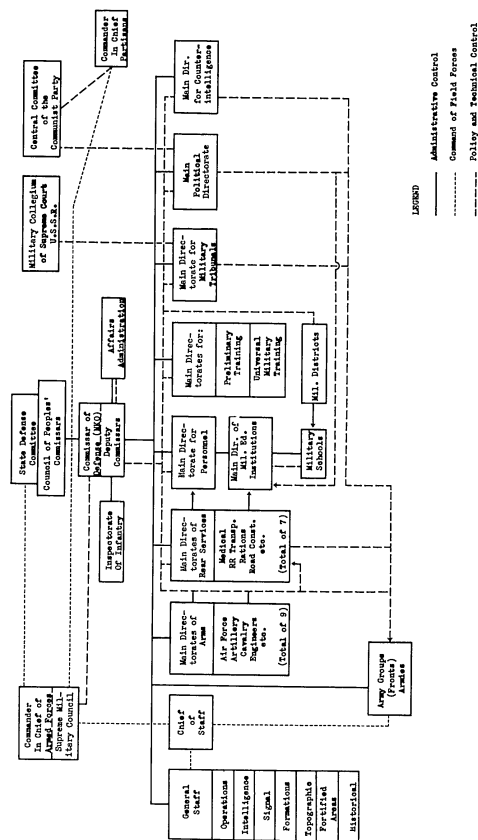

Reference: WFO 24-44, Chap. 2, p. 22.

SECRET

S E C R E T S E C R E T

A typical active front consisted of four or five infantry armies, one or two tank armies, one or two air armies, four artillery divisions, five antiaircraft artillery divisions, several independent brigades each of rocket launchers, heavy mortars, artillery, and self-propelled guns, and two tank corps, one or two mechanized corps, and one cavalry corps. Service units included engineer brigades, motor transport corps, signal intelligence, security, and penal battalions, replacement regiments, and various supply depots.

The Army was the basic strategic organization of combined arms. An army consisted of a large, permanent headquarters to which were assigned combat troops and services for the execution of a strategic mission. Armies differed greatly in size and purpose according to whether they were infantry, tank, cavalry, or shock armies.

A typical infantry army included three or four rifle corps of three or four rifle divisions each, a brigade of heavy artillery, a self-propelled gun regiment, an antiaircraft artillery regiment, and a heavy mortar regiment. Engineers were allotted to an army from the reserve of army group. Tank armies varied according to terrain and mission and generally formed part of the mobile reserve of the high command. Cavalry armies had two cavalry corps, one mechanized corps, and normal army service troops.

S E C R E T S E C R E T

SECRET SECRET

Shock armies were made up of picked divisions combined, according to their mission, to form powerful attack forces to be shifted from sector to sector as needed. The title "Guards" could be prefixed to any army (or lower unit) which had distinguished itself in combat. "Guards" units were upgraded in both personnel and equipment, actually having slightly larger tables of organization and equipment.

Corps were of two general types: the operational corps (rifle and artillery) and mobile corps (tank, mechanized, cavalry). The rifle corps was a forward headquarters having tactical control of from two to four divisions. The forward echelon headquarters of a rifle corps had a staff with operations, intelligence, signal communication, and penal sections, and artillery, engineer, and chemical warfare staffs. The rear echelon headquarters was a skeleton organization which consolidated reports and requisitions of the subordinate formations. Both rifle and artillery corps varied greatly in size and organization according to their mission. During the retreat of the Red Army at the beginning of the war rifle corps were largely eliminated and armies assumed direct control of divisions, but the rifle corps became fairly permanent organizations during the last year of the war. In contrast, the various mobile corps had been permanent formations with definite tables of organization and equipment more or less from the beginning

-84-

SECRET SECRET

SECRET SECRET

of the conflict.

The Soviet Rifle Division, comprising the bulk of infantry troops, underwent numerous changes in size and organization early in the war. The rapid expansion of the field forces and the shortage of officers adequately trained to command large forces of combined arms resulted in a reduction in the size of the rifle division. Most infantry heavy weapons and many specialized arms and services were withdrawn from infantry, cavalry, and armored formations and made independent, and the division organization was greatly simplified, thus making this unit (and its subordinate formations) much more efficient even when commanded by men lacking in specialized training and experience. This reorganization began even before the war with Germany. In April, 1941, the division was reduced from a strength of 18,841 to 14,454 officers and enlisted men, and from there to a total of 9,619 by May 1945. Though this was 4,444 less than a U.S. Army division at that time, its combat strength was only 200 less, the difference being accounted for by a correspondingly smaller number of supporting and service troops and smaller weapons crews in the Soviet divisions.

The Soviet infantry formation, except for size and the lack of certain supporting units, was so similar to its U.S. Army counterpart that little further discussion of Soviet field organization will be presented here. The division consisted of a

-85-

SECRET SECRET

SECRET
SECRET

Shock armies were made up of picked divisions combined, according to their mission, to form powerful attack forces to be shifted from sector to sector as needed. The title "Guards" could be prefixed to any army (or lower unit) which had distinguished itself in combat. "Guards" units were upgraded in both personnel and equipment, actually having slightly larger tables of organization and equipment.

Corps were of two general types: the operational corps (rifle and artillery) and mobile corps (tank, mechanized, cavalry). The rifle corps was a forward headquarters having tactical control of from two to four divisions. The forward echelon headquarters of a rifle corps had a staff with operations, intelligence, signal communication, and penal sections, and artillery, engineer, and chemical warfare staffs. The rear echelon headquarters was a skeleton organization which consolidated reports and requisitions of the subordinate formations. Both rifle and artillery corps varied greatly in size and organization according to their mission. During the retreat of the Red Army at the beginning of the war rifle corps were largely eliminated and armies assumed direct control of divisions, but the rifle corps became fairly permanent organizations during the last year of the war. In contrast, the various mobile corps had been permanent formations with definite tables of organization and equipment more or less from the beginning

-84-

SECRET
SECRETSECRET
SECRET

of the conflict.

The Soviet Rifle Division, comprising the bulk of infantry troops, underwent numerous changes in size and organization early in the war. The rapid expansion of the field forces and the shortage of officers adequately trained to command large forces of combined arms resulted in a reduction in the size of the rifle division. Most infantry heavy weapons and many specialized arms and services were withdrawn from infantry, cavalry, and armored formations and made independent, and the division organization was greatly simplified, thus making this unit (and its subordinate formations) much more efficient even when commanded by men lacking in specialized training and experience. This reorganization began even before the war with Germany. In April, 1941, the division was reduced from a strength of 18,841 to 14,454 officers and enlisted men, and from there to a total of 9,619 by May 1945. Though this was 4,444 less than a U.S. Army division at that time, its combat strength was only 200 less, the difference being accounted for by a correspondingly smaller number of supporting and service troops and smaller weapons crews in the Soviet divisions.

The Soviet infantry formation, except for size and the lack of certain supporting units, was so similar to its U.S. Army counterpart that little further discussion of Soviet field organization will be presented here. The division consisted of a

-85-

SECRET
SECRET

SECRET SECRET

headquarters, reconnaissance, engineer, signal, medical, and other service troops, an artillery regiment (three battalions), and three rifle regiments (three battalions each). During the winter of 1941-42, a great number of rifle brigades were activated (five battalions each), but at the close of the war very few brigades existed, most of them having been upgraded to divisions. A rifle regiment and a battalion each had a headquarters with an operational staff, and their company, platoon, and squad structure closely corresponded to U.S. Army organization.

5. Intelligence Functions of the General Staff and the Main Intelligence Directorate (GRU)

Within the framework of the Red Army, interrogation of prisoners was primarily the responsibility of officers assigned to intelligence sections of staffs at the various command levels. The army's role in interrogation, however, was almost entirely limited to the collection of tactical (combat) information. The NKVD conducted the "political" and strategic interrogation program and to a certain extent usurped armed force prerogatives in the matter of tactical interrogation as the war progressed. The latter agency also insisted upon the exclusive right to interrogate certain classes of prisoners such as captured agents, Russian prisoners who had escaped from enemy captivity, and local inhabitants suspected of subversive activities.

SECRET SECRET

SECRET

Figure 4.

MAIN INTELLIGENCE DIRECTORATE
(GRU)
RED ARMY GENERAL STAFF
1940
(Simplified Organizational Plan)

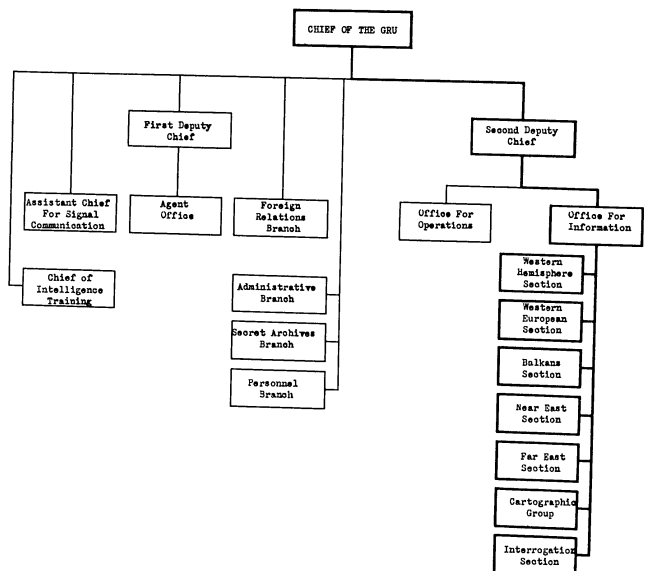

Reference: Survey of Soviet Intelligence and Counter-Intelligence, ID GSUSA, p. 48.

SECRET

S E C R E T S E C R E T

Much emphasis was placed upon the rapid evacuation of prisoners from lower levels of command to army level where they were turned over to the NKVD and evacuated to camps in the zone of interior. Intelligence officers in the lower headquarters were permitted only short periods for interrogating prisoners; nevertheless, provisions were made for the interrogation of important prisoners by military intelligence officers at army, front, and general staff level, and technical specialists among the prisoners were made available for interrogation by intelligence officers of appropriate arms and services. A limited amount of strategic intelligence could thus be developed by Red Army military intelligence at the higher levels, but commanders in the field were given only such information as was absolutely necessary to the performance of their military assignments. Strategic policy-making and planning was, of course, confined exclusively to a small body of individuals at the top of the Soviet hierarchy, and to these individuals complete information was available from all sources.

Prisoners of the Soviets undoubtedly endured most of their periods of questioning in the prisoner-of-war camps where the NKVD conducted interrogations. This fact probably led a number of former German staff officers writing on Soviet interrogation methods to state that after 1943, "the entire interrogation

S E C R E T S E C R E T

SECRET SECRET

organization was . . . centralized, taken away from the armed forces, and turned over to the . . . NKVD," and that "except for the direct procurement of tactical information on a low level, the army was altogether eliminated from carrying out PW interrogations." This observation is not entirely supported by evidence from other sources. While Red Army commanders were denied unlimited access to prisoner information usually available to the military commanders of other nations, it would seem that the former had adequate opportunity throughout the war to exploit prisoners for vitally important combat intelligence. This premise will be expounded in the following discussion of the intelligence organization of the armed forces and in the succeeding discussion of the NKVD.

The Main Intelligence Directorate (GRU) was the highest intelligence headquarters of the Red Army. It was an extremely complex organization with at least 350 officers, noncommissioned officers, and clerical helpers exclusive of subordinate detachments and individuals. The chief functions of the GRU were the procurement, evaluation, and dissemination of military intelligence and the commission of military espionage and acts of sabotage in foreign countries. The GRU, through the proper command channels, directed the activity of intelligence directorates (RU's) of army groups and military districts, and also of

-88-

SECRET SECRET

SECRET SECRET

intelligence sections (RO's) of armies and subordinate units. ⁷

An Intelligence Directorate of the Red Army had been established in 1921 as the Fourth Department of the General Staff. This organization had managed to maintain its existence without too much interference from the Cheka and its successors, the GPU and the OGPU. During the late 1930's, however, it suffered from penetration by the Directorate of State Security and was weakened as a result of the purges that took place. In December 1937, with the founding of the Commissariat of the Navy (NKVMF), the Red Navy founded its own Intelligence Directorate thereby further limiting the scope of Red Army intelligence agencies. ⁸

After the beginning of the war in June 1941, the situation gradually improved for Red Army intelligence agencies. The Intelligence Directorate was upgraded to the status of a Main Directorate and became the Second Division of the General Staff. The transfer of responsibility for counterintelligence from the NKVD to the HKO in 1943 (to be discussed under the section on the NKVD) gave the Red Army still more freedom for its intelligence activities. After numerous changes, the organizational structure of the GRU apparently was fairly stable from 1943 till the end of the war. As nearly as can be determined, the GRU was subdivided for administrative and operational purposes into

-89-

SECRET SECRET

SECRET SECRET

approximately nine principal offices or branches under a Chief and two Deputy Chiefs as shown in Figure 4.

The activities of the GRU fall into two principal categories: (1) intelligence collection and (2) evaluation and dissemination. Other activities of importance entailed the training of intelligence personnel (including agents), and signal intelligence (monitoring and communication with agents or agencies abroad).

In the formulation of strategic and tactical intelligence concerning foreign countries, both friendly and enemy, the Soviets characteristically placed great reliance and emphasis upon an extensive spy system. (Every communist abroad was a real or potential agent for the Soviets; extensive use was made of Soviet diplomatic and trade missions in perpetrating the espionage system). While the world-wide spy network was largely the responsibility of other agencies of the Soviet Government, the GRU was the recipient of much information from this source, and, in addition, a large part of its activities was devoted to the operation of its own network of agents in enemy territory.

The Office of Information (see Figure 4) is of specific interest to this study since it was the final recipient of prisoner-of-war interrogation reports from lower echelons of the armed forces. This office also conducted interrogations of especially important prisoners. Since the NKVD had complete

SECRET SECRET

SECRET SECRET

jurisdiction over prisoners after they reached army level in the process of evacuation, it seems likely that interrogation at GRU level was conducted in co-operation with (or even at the sufferance of) the NKVD.

The Information Office of the GRU was divided into geographic or regional subsections for Western Europe, the Balkans, the Near East, and the Far East; there were also interrogation and cartographic subsections. Specialists in various fields, such as economics, politics, and science, were employed to assist in the process of evaluation, and practically any agency of the army or the government could be called upon to assist in making evaluations of technical information.

Information from many sources which flowed into the GRU (including prisoner information) received initial evaluations from various receiving agencies and was then submitted to the responsible regional section of the Office of Information. The section determined whether the information was new and reliable. Considerable importance was attached to the counter-checking of reports from various sources, and the re-interrogation of prisoners was probably indicated at this point. Final evaluations were not necessarily made by the Office of Information but by the receiving agencies to which it was finally submitted.

SECRET SECRET

SECRET SECRET

Military and operational information was transmitted through channels to the Chief of Staff who combined it into a command estimate of the situation. Monoperational reports of strategic military significance were prepared and transmitted, as pertinent in each case, to the Historical and Topographic Divisions of the General Staff, to the Academy of the General Staff, or to Main Directorates of the arms and services. Information of nonmilitary character was disseminated through channels to the heads of other agencies of the Soviet Government. Ultimately, Stalin and the Politburo were the recipients of the most important intelligence developed by the GRU and other long-range intelligence services.

Daily intelligence summaries were issued during the war by the GRU to the intelligence staffs of army groups. A number of official staff and line journals, their circulation strictly limited by regulation to specified circles of officials and officers, devoted a portion of their contents to foreign intelligence.

The GRU co-operated closely with the small intelligence sections which were included in the organizations of most of the main directorates of the Peoples' Commissariat of Defense (MVD). These sections conducted a limited number of interrogations of prisoners who were technical experts in fields of interest to the directorates.

SECRET SECRET

-72-

SECRET SECRET

4. Staff Organization and the Intelligence Sections of Red Army Field Organizations

Below the level of the General Staff in the field organizations of the Soviet armed forces, the commander, his staff, the chiefs of various arms and services, and command liaison officers were the essential elements of the command of Red Army formations. Each element of the command had well-defined, specific responsibilities. The organizational structure may be seen in Figure 5.

The Commander of the formation was responsible for reconnaissance and operations in assigned areas of combat; the initial scheme of maneuver and the employment of reserves were his responsibility as was the success or failure of an operation. The chief of staff directed over-all planning, reconnaissance, co-ordination, combat security, signal communications, and supply control of operations. The chiefs of arms and services planned and supervised the operations of arms and services within the combat team. Command liaison officers (who were often either members of the staff or the chiefs of the various arms and services) represented the commander in the control of secondary operations.

The staff, or shtab, of a Red Army formation of combined arms, from army group down to corps level, was grouped under the chief of staff and consisted of the following sections: Operations (First Section), Intelligence (Second Section), Signal Communications,

-93-

SECRET SECRET

SECRET SECRET

Statistical Control, Topographic, and Headquarters Administration. (After 1944, the Statistical Control and Headquarters Administration Sections normally were removed from the staff and placed under the Deputy for Rear Services.)¹⁴

Intelligence sections at all levels in the Red Army served the commander of the formation or unit to which they belonged through the chief of staff; an intelligence section also directed and supervised, through command channels, the activities of the intelligence staff of the next lower headquarters.¹⁵

At army group level, the gathering, evaluation, and dissemination of intelligence was the responsibility of the second staff section or intelligence directorate (RU). The mission and the activities of the RU, as laid down in Soviet Field Service Regulations, were:

The RU gathers and studies information about the enemy, the topography and the population of enemy-held terrain; organizes all types of reconnaissance units in accordance with the intelligence summaries; prepares an intelligence code for the reconnaissance units; disseminates information about the enemy within the headquarters to higher and lower echelons and to neighboring units; organizes the reconnaissance duties of the headquarters and its lower echelons; studies the tactics of the enemy, the level of his technical preparation; and determines the strength and dispositions of the enemy forces. All items of information obtained through reconnaissance are transmitted by the chief of the RU directly to the chief of staff and, in some cases, to the commanding general himself.¹⁶

-94- SECRET SECRET

SECRET

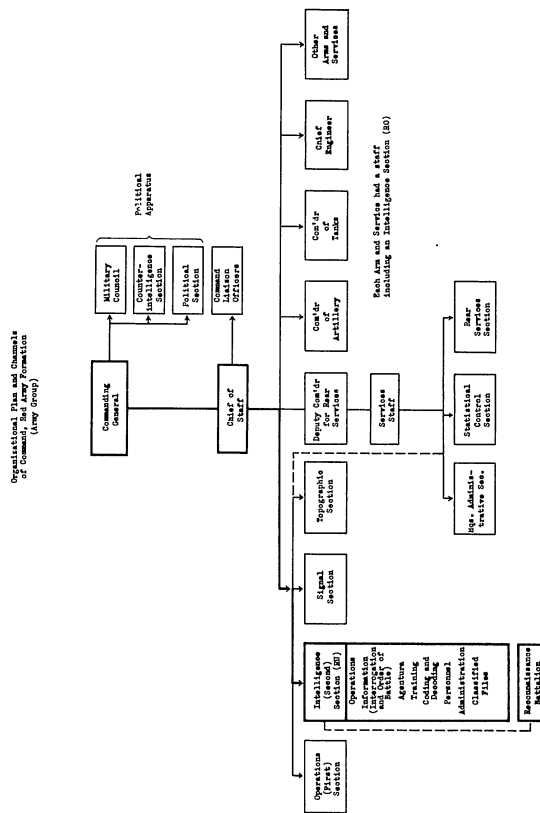

Figure 6.

Reference: RB 87-20-245, Chapter V, P. 4.

SECRET

SECRET SECRET

The organization of the RU closely paralleled that of the GRU and consisted of an Operations Section, Information Section, Communications Section, Agentura, Training Center, Coding and Decoding Section, Personnel Section, Administration Group, and a Classified Files Section. The total strength of an army group intelligence directorate, less agents, was from thirty to thirty-five officers and enlisted men. The exact composition of each of the sections is not known, but the Information Section, as in the GRU, was responsible for interrogation of prisoners and the evaluation of prisoner interrogation reports received from lower echelons or other sources. Order-of-battle files and maps were maintained at this level; radio monitoring and air reconnaissance reports were available along with other informational materials necessary to the operation of an interrogation center and for the evaluation of newly received information.

The various arms and services making up the army group each had a small staff including an intelligence section (RO) which generally consisted of an enemy situation group, an information group, and an interrogation group. The duties of such a section fitted the needs of its particular branch of service and supplemented the work of the RU with which it maintained direct contact. Technical specialists among the prisoners were sent to appropriate RO's for detailed interrogation.

SECRET SECRET

SECRET SECRET

A reconnaissance battalion, directly subordinate to the PU, was normally assigned to an army group. It had three companies of 115 men each and was motorized. Prisoner interrogation was considered a function of troop reconnaissance and was of much importance in Soviet intelligence doctrine. Many reconnaissance operations were directed and conducted solely for the purpose of taking prisoners for interrogation. Personnel of the reconnaissance battalion apparently carried out most of the interrogations of prisoners captured on such missions and reported to the information section of the RU. Especially important prisoners, such as generals and those connected with the enemy intelligence service, were interrogated directly by personnel of the information section.

Agents committed by the RU to espionage missions behind the enemy lines were customarily sent out in teams of three to eight men and with one or two radio sets. These teams, and other special groups of agents, penetrated as deep as fifty miles behind enemy lines. Agents frequently resorted to violence in order to obtain information; it was not uncommon for them to take prisoners, question them, and then kill them.

The RU received intelligence reports twice daily from intelligence sections of armies; and it may be assumed that other intelligence agencies within the army group made similar routine reports. The RU, in turn, consolidated these reports into an army

-96-

SECRET SECRET

SECRET SECRET

group situation report which was sent daily to the GRU in Moscow. In addition to these routine reports, especially important information was forwarded immediately to interested agencies in both higher and lower echelons. Prisoner-of-war statements were also compiled into special reports in the information section of the RU and sent to the GRU for final evaluation and dissemination. Subordinate armies of the army group received daily intelligence reports from the RU. In addition to the daily reports, the information section also issued an information bulletin every ten days which summarized the enemy situation in the army group sector, contained conclusions regarding enemy intentions, and made reconnaissance requests.

Staff organization and the duties of the intelligence sections (RO's) at army, corps, and division level corresponded, within narrowing limits, to army group headquarters organization. Except for a very few important prisoners who were sent to the RU and GRU for interrogation, the final tactical interrogations by Red Army intelligence personnel took place at army level since prisoners were turned over to the NKVD there for evacuation to the zone of interior. Interrogation was one of the most important functions of an army RO, and whenever the identity of enemy units opposing an army was not clearly known, the RO ordered an aggressive use of patrols to bring in prisoners for questioning. The RO's

-97-

SECRET SECRET

SECRET SECRET

of specialized branches of the arms and services also conducted exhaustive interrogations in their own fields supplementing the work of the army RO in the same manner as at army group level.²⁰

The RO of an army staff was subdivided into troop reconnaissance, information and interrogation groups, a radio station, and a cryptographic office.²¹ The chief of the information group and his deputy, with the assistance of at least three interpreters, evaluated intelligence reports, prisoner-interrogation reports, and captured documents received from lower echelons and combined them into enemy situation reports and maps.²² Consolidated reports were received twice daily from lower echelon RO's, and the army, in turn, sent consolidated reports twice daily to the army group RU. Important information (as at all command levels) was forwarded to interested agencies immediately by the fastest means of communication available. The army RO also issued an intelligence summary to lower echelons every ten days containing the same type of information as that issued by the army group RU.²³

A large part of the information secured by an army RO was secured through channels from lower (front line) echelons. Routine interrogations conducted by lower headquarters extracted from most prisoners all information of value they had to offer. An examination and comparison of interrogation reports would naturally result in the re-interrogation of a few of the rank-and-file captives.

-98-

SECRET SECRET

SECRET SECRET

as soon as possible after their capture important prisoners were usually conducted back to the army RO by mobile means for detailed interrogations.

The army RO normally had at its disposal two independent reconnaissance companies of 115 men each, and patrols from these companies were frequently used to bring in prisoners for direct questioning by army RO interrogators.

In addition to prisoners as a direct means of securing intelligence, the army RO also secured information by means of troop reconnaissance, wire-tapping, and agents. After 1943, the commitment of agents became, according to regulations, the sole responsibility of the army group RU, but armies, corps, and even divisions actually continued to make use of "line-crossers" as an important means of securing information. Air reconnaissance, however, was conducted exclusively by army group after 1943, more particularly, by the air armies. Requests for air reconnaissance were forwarded from lower echelons through the army RO to the army group RU.²⁴

From the standpoint of prisoner interrogation, the Soviet rifle corps headquarters was probably the least important of all the echelons in the chain of command. Under normal circumstances prisoners were evacuated directly from division to army. Only one interpreter was assigned to the corps RO, and interrogation of prisoners was customarily performed only when it was thought that

-99-

SECRET SECRET

SECRET SECRET

certain prisoners could clarify the immediate situation facing
the corps.²⁵

Divisions and other subordinate units of a rifle corps were being constantly assigned and detached in the Soviet armed forces during World War II; consequently, there was little continuity in the association of corps staff personnel with those of lower headquarters. The corps intelligence section (RO) therefore limited its activities largely to the collection and dissemination of information of immediate interest to the corps, and reconnaissance activity was limited to the planning and ordering of reconnaissance missions by subordinate units. The corps estimate of the situation was based largely on reports received both from higher and lower echelons rather than on intelligence obtained by personnel and agencies assigned directly to the corps RO.²⁶ A captured Soviet officer who had been assigned to a corps headquarters told his German captors that "the results of ground reconnaissance by the various reconnaissance agencies constitute the main source of information on the enemy situation."²⁷

The organization of a rifle corps intelligence section included personnel as follows: a chief of section, a reconnaissance officer, an information officer, an interpreter (usually an officer), and a clerk-typist.²⁸ Generally speaking, the relationship of a corps RO to the corps commander, to the chief of staff, and to

-100-

SECRET SECRET

SECRET SECRET

other elements of the command was the same as that of the army
RO.²⁹

Tank, mechanized, and cavalry corps were much more permanent organizations, as compared with the rifle corps, and their RO's had more far-reaching functions. These corps often operated independently without close connection with army, and the nature of their operations resulted in the taking of a comparatively large number of prisoners. Prisoner interrogation thus assumed greater importance in these corps than in the rifle corps, their RO sections had more personnel, and reconnaissance missions were performed under the direct supervision of the corps RO.³⁰

The first thorough interrogation of prisoners took place at divisional level in the Red Army. Preliminary, brief interrogations usually took place at battalion and regimental level, but the interpreter at the divisional RO made the principal interrogation and prepared a detailed written report on each prisoner interrogated.

The chief of the intelligence staff section (RO) of a rifle division was the second senior staff member below the chief of staff and had essentially the same responsibilities as staff intelligence officers in the higher echelons. The intelligence section, in addition to the chief, consisted of one assistant (for planning and evaluation of troop reconnaissance) and one interpreter. Clerk-typists and other personnel were drawn from

-101-

SECRET SECRET

SECRET SECRET

the divisional reconnaissance company as needed. The rifle divisional reconnaissance company had a strength of 74 men and was under the direct supervision of the chief of the RO while a cavalry division had a reconnaissance battalion with a total strength of about 500 men.³¹

In general, the relationship of the divisional RO to the various command elements of the formation was the same as that of the corps and army RO except that the divisional RO worked in much closer co-operation with intelligence personnel of the subordinate units within the division. As a front line organization in direct contact with the enemy, the divisional RO was a primary collecting point for vital, first-hand combat intelligence. Principal sources of intelligence were intensive ground observation and reconnaissance, prisoner interrogation, and exploitation of captured documents, which the Soviets considered a vital source of reliable information. Specialized intelligence was procured through similar sources and services assigned to the division.

Prisoners were kept at divisional level for a very short time (one to three hours) and were then sent on to corps or army. Copies of the interrogation reports accompanied the prisoners to higher headquarters, and, on the basis of those reports, corps and army RO's (and specialized intelligence units) selected

-102-
SECRET

SECRET

SECRET

individual prisoners for further interrogation. Captured documents were also sent to higher headquarters after a brief scanning at division.

Because of its proximity to the front lines, the RO at division made numerous reports concerning important changes or developments in the situation to higher, lower, and neighboring units as soon as information had been received and evaluated. In addition to these "spot-news" reports, routine reports were sent twice daily to corps (or army), and lower units were briefed frequently on the enemy situation.³²

At regimental level, in both infantry and artillery regiments, the second assistant to the chief of staff (PNSh 2) was responsible for the direction of intelligence activities. A staff interpreter was assigned to the PNSh 2 to assist in the interrogation of prisoners and the evaluation of captured documents. A reconnaissance platoon of 23 men and a cavalry squad of 14 men were assigned to an infantry regiment. An intelligence platoon was assigned to the headquarters battery of an artillery regiment, and a reconnaissance squad detached from this platoon was sometimes attached to an artillery battery. The PNSh 2 was chiefly concerned with the collection, evaluation, and forwarding of information and, in carrying out the approved divisional intelligence plan, was authorized to issue direct orders both to

-103-
SECRET

SECRET

SECRET SECRET

divisional and regimental reconnaissance units. Frequent patrols were ordered by the PNH 2 to bring in prisoners who were interrogated briefly before being evacuated to division.

The regiment was the lowest echelon in which an officer was assigned specifically to intelligence duties and nothing else. In battalions the deputy commander carried on intelligence activities in addition to his tactical duties. German-speaking personnel was plentiful in the Red Army, and interpreters (though untrained in intelligence methods) were usually available to battalion and company commanders for purposes of interrogating German prisoners.

5. Soviet Para-Military Political, Security, and Counterintelligence Agencies

The Main Political Directorate of the Commissariat of Defense, the Commissariats of State Security and Internal Affairs, the OO NKVD, and the latter's successor, the GUKR NKO (Smersh), were all concerned to a greater or less degree with the interrogation of prisoners of war. Their inner relationships and the intricate divisions of function and authority delegated to these organizations were so complex that even Soviet citizens were often confused, especially since marked changes in organization and responsibility took place during the war. One thing these agencies had in common was well recognized by all: they were instruments of the Communist

SECRET SECRET

SECRET SECRET

Party with the function of insuring the security of the Soviet regime. Consequently, they were feared both by Soviet citizens and by prisoners of war.

a. The Main Political Directorate

The Main Political Directorate played a major role in the interrogation program, especially during the latter stages of the war. This directorate maintained political staffs in the field headquarters of the Red Army in echelons down to and including divisions. Little information is available on the tables of organization of these staffs, but it may be assumed that several interrogators and interpreters were assigned to the political section at division headquarters. At this level prisoners were subjected to long, exhaustive interrogations covering their personal history, politics, and morale, and any observed effects of Soviet propaganda on German soldiers. An example of a political questionnaire is reproduced in Appendix III, Item 2, with a directive, Item 1, outlining methods to be employed in conducting such interrogations.

Information gained by members of the political staff was not made available to military intelligence, but rather the reports were sent through Political Directorate channels to the main office in Moscow. A copy of each interrogation report,

SECRET SECRET

SECRET SECRET

presumably, was turned over to the NKVD at the camp where the prisoner was sent, thus contributing to the frequent assumption of the German prisoners that the political interrogation in the field had been conducted by the NKVD.

Since the Main Political Directorate conducted the psychological warfare program in the field, its interrogators were particularly interested in securing ideas and material to use in propaganda leaflets and front-line loud-speaker broadcasts. Other functions of this agency were the strengthening of the Communist party in the Red Army and the political indoctrination of Red Army troops, partisans, civilians in occupied areas, and prisoners. Personnel were attached to the various staffs as political officers or "commissars," while others were assigned to troop units where they exercised a decisive influence in maintaining morale and fighting spirit in the ranks. Although this directorate was constitutionally subordinate to the NKVD, actually it was the chief agency of the Communist party for control of the Red Army and received its basic directives from the Central Committee of the party.³⁶ (See Figure 3).

The commissar, to quote an official directive, was the "Father and Soul" of his military unit and during the war with Finland the ranking political commissar of a military unit enjoyed greater authority than its tactical commander. Differences

-106-

SECRET SECRET

SECRET SECRET

of opinion between commanders and commissars on purely military matters during the Finnish Campaign (1939-40) led to reverses in the field, with the result that in 1940 commissars were reduced to the status of assistant commanders for political matters only. The military reverses in the summer of 1941 which led to wholesale surrenders, desertions, and low morale caused Stalin to reinstate the commissars in order to restore discipline, morale, and patriotism. Military commanders, whose prestige and influence increased as the war progressed, naturally resented interference in tactical matters. Because of the growing pressure from the Army, plus the critical military situation, Stalin again reduced the status of commissars in October 1942 to that of assistant commanders for political matters only. At this time, commissars were put in uniform and given military rank which, in division and lower commands, was usually equivalent to that of the chief of staff. At army group level, the head political officer was chief of the political directorate attached to headquarters.³⁷

b. History of the Soviet Secret Service

Although the military intelligence agencies conducted tactical interrogations of prisoners, the Commissariat of Internal Affairs (NKVD) was the most important single agency involved in the interrogation of captured personnel. In addition to the strategic

-107-

SECRET SECRET

SECRET

SECRET

interrogation program, the NKVD had the entire responsibility of evacuating prisoners from the combat areas (that is, from prisoner-of-war cages at army level) and for their security, care, utilization, and "political re-education" (propagandization) in prisoner-of-war camps. These activities were only a small part of the responsibilities of the NKVD which exercised a dominating influence over practically all citizens and enterprises of the Soviet Union. Its work was intimately related to that of the Commissariat of State Security (NKGB), and, in order to clarify their relationships, it is necessary to review briefly the history of these two organizations.

Following the Bolshevik seizure of power in the 1917 revolution, the Cheka -- "The Extraordinary Commission for the Fight Against Counter-Revolution, Sabotage, and Speculation" -- was organized. This agency became the executive arm of the Bolsheviks and used terroristic methods to gain and hold power for the minority political group which had engineered the revolution. Police terrorism, an informant net within the country, and subversive propaganda in foreign countries were methods utilized by the Cheka which have characterized Soviet secret service methods ever since.

In 1922, the Cheka was renamed, to reduce its notoriety, the State Political Directorate (GPU) and had a strength of

-108-

SECRET

SECRET

SECRET

SECRET

more than 100,000 members. A year later it was constitutionally legalized as the United State Political Directorate (OGPU) with branches in the various republics (GPU's). Internal security and border troops were placed under the jurisdiction of the OGPU which also set up so-called "Military Sections" (VO GPU) for surveillance of the Red Army and Navy.

In 1934, the newly organized Peoples' Commissariat of Internal affairs (NKVD) absorbed the OGPU along with all local police organizations (militia) and firemen. Secret service operations were consolidated into the Main Directorate for State Security (GUGB) of the NKVD. The military surveillance sections were enlarged and renamed Special Sections (OO) of the NKVD. Other sections of the GUGB, the Foreign Section (INW) and the Counterintelligence Section (KRO), were the principal agencies of secret service operations abroad. Along with these organizational changes, the NKVD received unlimited power through the passage of Articles 58, 1b, 1v of the RSFSR Code in 1934. The NKVD reached the peak of its power in 1939 at which time it embraced the entire Soviet secret service, domestic and foreign. Its total personnel numbered at least a million persons.

A brief attempt was made early in 1941 to give the GUGB the status of a peoples' commissariat, but this was dropped with the beginning of the war with Germany, and the OO NKVD maintained its

-109-

SECRET

SECRET

SECRET SECRET

surveillance operations throughout the Soviet armed forces. These units were alien to the structure of the Red Army, and there was apparently a strong desire on the part of the military to eliminate NKVD surveillance and to put the entire military intelligence and counterintelligence service under the jurisdiction of the Commissariat of Defense (NKO).

Accordingly, in the spring of 1943, sweeping reorganizational changes were instituted. A Main Directorate of Counterintelligence (GUKR NKO) was organized which was promptly nicknamed Smersh, or "Death to the Spies." This dramatic title was intended, at least in part, to camouflage the principal function of the organization which was still surveillance over Red Army personnel. GUKR units attached to the lower headquarters of the field forces were known as OKR NKO ⁴⁰ Smersh. From a practical standpoint, all that happened was that members of the OO NKVD now put on uniforms and assumed military rank (with the letters GB -- "State Security" -- attached to their rank designations) along with a new name for their organization GUKR NKO (Smersh). Personnel and functions remained the same.

At the same time the above mentioned changes took place, the GUGB was separated from the NKVD and made the Peoples' Commissariat of State Security (NKGB). The GUKR (and its subordinate units) and the NKGB, thus, were both off-shoots of the NKVD, and all

-110-

SECRET

SECRET

SECRET SECRET

three agencies continued to maintain close relationships. The Red Army theoretically had its own counterintelligence service, but in reality the GUKR received its directions from the NKGB. A Smersh unit attached to a field headquarters of the Red Army, for instance, was responsible not to the military commander of the unit but to the Smersh unit of the next higher headquarters. ⁴¹

c. The NKVD

The Peoples' Commissariat of Internal Affairs (NKVD) and its activities are of primary interest to this study since this agency conducted some of the tactical and practically all of the strategic prisoner-of-war interrogation program. Military regulations required that prisoners be evacuated as rapidly as possible from the point of capture back to army headquarters where jurisdiction over them passed from the Red Army to the NKVD. Military intelligence officers and interrogators of forward echelons of the army were enjoined to question prisoners briefly and only on matters pertaining to the immediate tactical situation. From NKVD-operated prisoner-of-war cages at army level, prisoners were evacuated directly to prison camps in the interior of Russia under the guard of NKVD Convoy and Railroad Troops. ⁴² Above army level, military intelligence agencies (the RU's and the GRU) were permitted to question only a very few of the more important prisoners. The

-111-

SECRET

SECRET

SECRET SECRET

military surveillance units of the NKVD (until their transfer to the GUKR NKO in 1943) interrogated enemy deserters, recovered Red Army personnel, suspected enemy agents, Soviet citizens in areas recovered from the enemy, and other categories of personnel suspected of subversive tendencies or activities.

In addition to prisoners captured by the Red Army and turned over to the NKVD, prisoners were also captured by NKVD Border Troops and Security Troops. These semi-military units included intelligence divisions in their organizations which conducted both tactical and strategic interrogations of prisoners.

Semimilitary NKVD guard units operated all the prisoner-of-war camps where NKVD interrogation teams conducted an exhaustive strategic and "political" interrogation program. In the prisoner-of-war camps, the NKVD was also responsible for the political "re-education" program and the promulgation of various anti-fascist movements such as the antifa movement and the Free Germany Committee among the prisoners. Prisoners of all enemy nations were subjected to this propaganda program. NKVD control of prison labor, both domestic prisoners and prisoners of war, involved the NKVD in extensive construction, mining, fishing, and development projects. Providing manpower for construction and maintenance of all roads and highways, for instance, was one of the responsibilities of this Commissariat.

-112- SECRET SECRET

SECRET

Figure 6.

Organization of the People's Commissariat of Internal Affairs (NKVD)

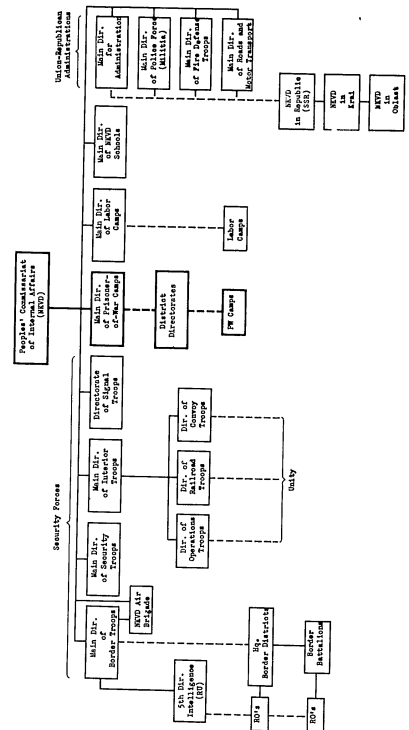

Reference: NKVD, 1937, p. 12.

SECRET

SECRET SECRET

During World War II, literally millions of prisoners fell into the hands of the Russians. The task of caring for these prisoners was only one of the NKVD's many important responsibilities. The principal mission of the NKVD was the maintenance of internal security in the Soviet Union. In the execution of this mission, the NKVD conducted frontier and coastal patrols and security operations in the rear areas of combat zones, controlled all local police and fire departments, maintained special troops for use against sabotage and insurrection, was responsible for massive air-defense measures, had certain responsibilities in the conduct of partisan warfare in enemy occupied territories, and conducted many other types of counterintelligence and security activities.⁴³

In its organizational structure, the NKVD consisted of approximately eleven main directorates. (See Figure 6.) A number of these directorates had counterparts in the governments of the various republics; others, such as the Main Directorate of Prisoner-of-War Camps, were "All-Union" organizations which directed their operations from Moscow without reference to the republics.

Comparatively little well-substantiated information is available on the organization of the Main Directorate of Prisoner-of-War Camps. The following discussion and the accompanying

SECRET SECRET

SECRET SECRET

chart (Figure 7) are based on a report by a former German prisoner who served as an interpreter and bookkeeper in a Soviet prison camp from February 1946 until September 1947 (after the NKVD had become the MVD).

The former German prisoner stated that Soviet prisoner-of-war camps were administered by the MVD through its Department Seven (probably a numerical designation for the Main Directorate of Prisoner-of-War Camps). Subordinate to Department Seven were District Directorates of the Affairs of Prisoners and Internees, each of which was responsible for appointing the commanders of camps within its district. At least three different officers served on the staff of the district commanders: a Political Officer in charge of the political indoctrination of prisoners and of the district antifa school, an Operations Officer in charge of interrogations and investigations, and a Sanitation Officer. The Operations Officer co-ordinated his investigations with those of the district prosecutor in their attempts to seek out war criminals. The staff of a Camp Commander (Nachalnik Lagera) included officers in charge of the following sections: mess supply, clothing supply, political, labor, finance, and administration and transport officers.

The camps were assigned guard and escort personnel, according to the German source, by the Main Directorate of MVD Troops

-114- SECRET SECRET

SECRET

Organization of the Main Directorate of the Affairs of Prisoners and Internees of the Ministry of Internal Affairs (MVD) (Postwar - 1947)

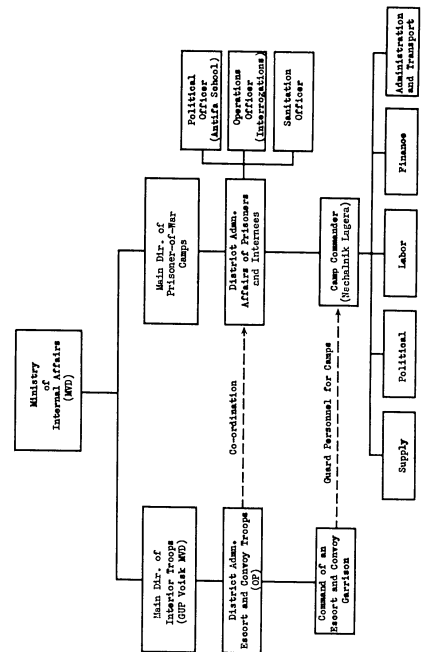

SECRET

Reference: WDCS, Report No. RT-194-50

Figure 7.

SECRET SECRET

located in Moscow.⁴⁶ A District Directorate for Escort and Convoy Troops (Oblastnoye Pravlenie) supervised and directed such troops at the district level. A so-called Command of an MVD Escort and Convoy Garrison (Nechalnik Garnison Konvoinikh Voisk MVD) was the lowest echelon (camp level) in this branch of the MVD troops. Guard personnel was assigned to camps at a ratio of one guard for every four or five convicts, one guard for every ten prisoners in training camps, and one guard for every twenty to sixty prisoners in ordinary prisoner-of-war camps.⁴⁷

Officers and enlisted men were interned in different camps, and officers were further separated in camps for company grade, field grade, officers of the General Staff, and general officers. In camps for enlisted men, officers were assigned only to the extent required to perform necessary administrative duties.⁴⁸ German medical personnel were assigned to camps to administer to prisoners' medical needs, though lack of medicines and instruments resulted in entirely inadequate medical care for the prisoners. Although prison camps were scattered all over the Soviet Union, sub-camps were set up close to labor projects or factories to reduce the amount of time consumed in marching to and from work. Highly qualified specialists were sometimes billeted at their places of work where they were guarded loosely

SECRET SECRET

SECRET SECRET

or not at all. Other categories of camps included those for political prisoners (members of the Waffen SS, Allgemeine SS and other members of Nazi Party organizations) where conditions were usually far more rigorous than in ordinary camps; special punishment camps about which little is known;⁴⁹ and camps where selected prisoners received special courses of training (e.g., Antifa schools) from which they were sent to other camps to carry on political propaganda or to their homes as repatriates to form the nucleus of a Communist movement in their native countries.

Conditions in the camps were invariably harsh if not completely brutal, though it should be noted that the Russians did not treat their own people any better in Soviet labor (concentration) camps. All prisoners were required to work at tasks which included strictly military projects such as manufacturing and transporting ammunition or clearing mine fields in the most advanced front lines. Shelter consisted of crowded wooden barracks or earthen bunkers surrounded by several rows of barbed wire, and every camp included a "punishment bunker," a prison with solitary confinement cells. A large number of prisoners died in these camps from hunger, disease, exposure, and overwork.⁵⁰

An NKVD interrogation team was invariably attached to the staff of each of the "political" camps but not necessarily to each of the ordinary prisoner-of-war camps.⁵¹ The leaders of these

-116-

SECRET SECRET

SECRET SECRET

teams were skillful linguists and trained, experienced interrogators; toward the end of the war, members of these teams were possessed of a surprisingly detailed knowledge of military, technical, and industrial matters upon which they wished to secure additional information. The interrogation teams placed stool pigeons among the prisoners, especially in the punishment bunkers, who conducted intensive and continuous spy activities.

Of interest to this study is a postwar report concerning a prisoner-of-war camp located near Moscow where particularly important prisoners -- generals, staff officers, strategists, scientists -- were brought together for careful and intensive interrogation by a special staff of investigators.⁵² Approximately 6,000 prisoners were kept at this center which had a staff of at least 500 Soviet investigators, interrogators, and administrative personnel. The camp functioned, in part, as a research center for foreign military strategy. Preliminary interrogations were said to last for three months after which less important individuals were transferred to other camps while the remaining prisoners were subjected to further detailed interrogations. The most important of the latter group were sometimes transferred to an MVD interrogation center in Moscow.⁵³ Every nationality represented among the prisoners had its own Communist Party organization, and all prisoners were required to attend classes where they were subjected

-117-

SECRET SECRET

SECRET SECRET

to pro-Communist propaganda.

Both before and during the war, the USSR maintained a large force, the Border Troops, which were charged with the security of the land and sea frontier. The border of the USSR was divided into Border Districts manned by Border Battalions which averaged from 1,000 to 1,200 in strength and which maintained a 24-hour guard over zones extending back from the frontier approximately sixty miles in depth. An Air Brigade, directly subordinate to the NKVD, assisted the Border Troops in the performance of their security mission.

As the Border Battalions entered the theaters of operations during World War II, they were redesignated Security Troops of the Rear Area of the Red Army, and a separate Main Directorate was created to supervise this body of troops. (Figure 6.) The individual battalions were re-organized as Security Regiments which were subordinate to army groups where they came under the command of the Chief of the Security Troops of the Rear Area. Normally, one Security Regiment was assigned to the rear of each army where their mission was to apprehend enemy agents, Red Army stragglers, and deserters, and to eliminate enemy parachute or reconnaissance units which had penetrated into the rear area.⁵⁴

The Main Directorate of Border Troops included a 5th (Intelligence) Directorate (hU). Border Battalions and Security

-118-

SECRET SECRET

SECRET SECRET

Regiments each had Intelligence Sections (RO's). All such intelligence sections were similarly organized and had four subsections: (1) Section for Border Intelligence -- observation of the loyalty of the Soviet population in the Border District and detection of espionage activities; (2) Section for Foreign Intelligence -- procurement of information and conduct of counterespionage in adjacent foreign territory; (3) Section for Information -- collection, evaluation, and dissemination of information and interrogation of prisoners; and (4) Assistant Chief for Signal Communications.⁵⁵

The Border Troops were but one of the semimilitary forces of the NKVD. The Interior Troops were mobile forces organized to insure the security of the state. Operational Troops were responsible for security of the interior of the country and of key installations and individuals; when necessary, they guarded railroads and prisons. Railway Troops normally defended railway lines and installations and operated armored trains. Convoy Troops protected the movement of all troops and supplies and convoyed prisoners to prison camps from the rear areas of armies. Signal Troops of the NKVD, apart from their principal functions of improving communications security of all agencies of the Soviet Government and maintaining communications systems for NKVD staffs and units, performed the important intelligence operation of

-119-

SECRET SECRET

SECRET SECRET

56

monitoring enemy broadcasts.

The security forces of the NKVD were made up of carefully selected individuals; practically all of them were members of the Communist Party or the Komsomol. During World War II the combined strength of these units was well over half a million. ⁵⁷

The security mission of the NKVD was shared, after 1943, with the NKGB. The latter Commissariat was responsible for nonmilitary secret service operations, both at home and abroad. Except for the fact that the NKGB exercised direct, though unofficial, supervision over the military surveillance units (OKR NKO Smersh), the Commissariat had very little to do with the prisoner-of-war interrogation program; consequently, no further delineation of its organization will be presented here. ⁵⁸

d. Main Counterintelligence Administration of the Armed Forces (GUKR)

As has been noted, the Special Sections of the NKVD (OO NKVD) which maintained surveillance over the Soviet Armed Forces were placed under the jurisdiction of the Peoples' Commissariats for Defense and for the Navy by order of the State Defense Committee on 10 May 1943. This was simply a "paper" transfer; personnel of the OO NKVD put on military uniforms and became members of the Main Directorate of Counterintelligence, but their mission and methods of operation remained the same. ⁵⁹ Despite the transfer

-120-

SECRET SECRET

SECRET SECRET

to the armed forces, the GUKR NKO (Smersh) continued to take directions, unofficially, from its former parent organization, the GUGB, now the Peoples' Commissariat of State Security (NKGB). Since officials of both the Smersh units and the NKGB were originally members of the NKVD and had been trained in NKVD schools, relations among the three agencies were close, and they maintained a continuous exchange of information on matters of mutual interest. The GUKR NKO also co-operated closely with the Main Political Directorate of the NKO. ⁶⁰

The missions of the GUKR NKO and its subordinate organizations were supervision of the loyalty of individual members of the Soviet Armed Forces, the detection of foreign espionage agents and activities, and the performance of counterintelligence missions in enemy areas. ⁶¹ Interrogation of captured personnel and, more frequently, of Soviet citizens and members of the Red Army played an important but comparatively minor part in the over-all operations of the Smersh units. The following brief discussion of Smersh organization and operations at various levels in the armed forces will be followed, in turn, by a more definitive discussion of Smersh activities and prerogatives in the field of interrogation.

Activities of the GUKR NKO at Moscow level were directed by a chief with the assistance of a Secretariat and an Administrative Bureau. Individual zones of activity were divided among

-121-

SECRET SECRET

SECRET SECRET

approximately thirteen sections; UKR's of fronts and armies had almost identical, though correspondingly smaller, organizations. The thirteen sections were entitled: Staff Surveillance, Troop Surveillance, Counter-Espionage, Technical and Signal Surveillance, Co-operation with Partisans, Investigation, Censorship, Security Control, Information, Cipher, Personnel, Komendantura (Police with subordinate guard companies), and Troika (a summary court). In most cases the titles of the sections are indicative of function. Each of these sections supervised and directed the activities of its corresponding section in the next lower echelon.

At corps and division level the Smersh unit (OKR) usually consisted of a chief and four assistants who headed Operations, Investigation, and Administration Sections, and a guard platoon. At regimental and battalion levels, the Smersh organization was represented only by individual Plenipotentiary Operatives who directed and supervised the activities of numerous informers, each of whom was recruited secretly from the ranks by a plenipotentiary and required to spy upon an assigned number of immediate associates.

A Smersh unit was attached to the headquarters of a Red Army field organization for "quarters and rations," but it was neither under the command of nor responsible to the commanding officer of the military unit. Rather, it was an independent police and spy

-122-

SECRET SECRET

SECRET SECRET

organization within the military unit to which it was attached, and each Smersh unit was responsible only to its superior unit at the next higher echelon of the military command. At army level a UKR NKO unit consisted of from 75 to 100 officers and men plus a guard company with a strength of at least a hundred men. At corps level an OKR unit had a strength of approximately twenty officers and men with a guard platoon of from twenty to thirty men, and at division the strength was approximately ten officers and men plus a guard platoon.⁶³ (Personnel of the guard complements served as guards for Smersh installations and as guard-escorts for prisoners.) Working directly under the divisional Smersh unit were three regimental and nine battalion plenipotentiary operatives.

The principal mission of Smersh, that of surveillance, was carried out by informers recruited from the ranks by the regimental and battalion plenipotentiaries. The names of these informers were kept very secret -- each informer knew only the person to whom he made reports. This complex spy network, in one way or another, involved about one-sixth of the members of the armed forces. Quite understandably, Smersh was both feared and hated by the military, from the highest commander to the lowest private, but no individual dared refuse when recruited as an informer for fear of becoming suspect. Having become a stool pigeon, he had to report faithfully every suspicious word and deed; an overlapping

-123-

SECRET SECRET

SECRET SECRET

system of surveillance permitted a check on the accuracy and completeness of the reports of each informer. Even small patrols usually included one informer to insure no desertions. In times of battle, the informers were authorized to take direct action to prevent cowardice or desertion. Because of the large number of informers, penetration of Soviet ranks by enemy agents was made extremely difficult. The Germans have testified that the system was an effective counterintelligence measure against their own secret service.⁶⁴

Of particular interest to this study are the operations of the Investigation Sections which conducted most of the Smersh interrogations. Smersh units exercised powerful prerogatives over the army in reserving for themselves the exclusive right to interrogate certain categories of prisoners of war and various groups of Soviet soldiers or citizens suspected of disloyalty. The punitive function of Smersh was indicated by its title, "Death to the Spies." During the war, Smersh units were authorized to translate this title into direct action. Prisoners suspected of being spies, fanatical Nazis accused of atrocities, and Soviet soldiers or citizens accused of disloyalty were frequently shot by the Smersh units; no trial was necessary -- only a brief investigation and interrogation conducted by the Investigation Section. Such executions were usually conducted in secret.⁶⁵

-124-

SECRET SECRET

SECRET SECRET

As has been noted, Smersh units conducted interrogations of both Soviet and enemy personnel. A captured order stated that, "All persons who come from the enemy side of the front are to be arrested and brought to the counterintelligence Smersh units."⁶⁶ Both the Germans and the Russians frequently recruited agents from among prisoners of war or captured spies and attempted to send them back to their units to act as "double-agents," to commit acts of sabotage, to spread subversive propaganda, or to recruit deserters. Similar attempts were made to recruit agents from among the civilian population of an occupied area. (This was particularly effective when the recruiting agency could hold members of the recruit's family as hostages thus insuring the "loyalty" of the agent.) The Soviets, therefore, had well-founded reasons to suspect the loyalty of any of their own personnel who, for any reason, had returned from behind enemy lines. Returnees' explanations (such as having been surrounded, cut-off, or having escaped from capture) were regarded as "cover stories" given to them by the enemy intelligence service until thorough investigation had proved otherwise. The principal categories of Soviet personnel interrogated by Smersh units were:

- (a) Soviet officers or enlisted men turned up by the surveillance network who were suspected or accused of disaffection, disloyalty, cowardice, or sabotage, or of acting as agents for the enemy;

-125-

SECRET SECRET

SECRET SECRET

- (b) All Soviet deserters.
- (c) All Red Army troops who had been surrounded or cut off by the enemy.
- (d) All Soviet returnees who claimed to have escaped from enemy capture, or who had escaped capture after having been cut off or wounded behind the enemy lines.
- (e) All recruits for the Red Army from territories occupied at any time by the enemy.
- (f) Soviet civilians in territories recovered from enemy occupation.⁶⁷

Obviously, in the case of large units which had been surrounded by the enemy, investigation would have consisted of a routine screening of the individuals, but the smaller groups and individuals were carefully investigated, especially if they had been absent from their organizations for some time.

No Soviet commander was permitted to take a former serviceman (who had returned from enemy lines) into his unit without permission or order of a Smersh unit. To reinstate a former officer or noncommissioned officer required the approval of the chief of a Smersh unit at army group level. All returnees whose cases were questionable were sent to "special camps" operated by the NKVD. During the war there were usually one or two of these observation camps for each front. Following a period of investigation and observation, the fate of each individual was decided by a Troika (a summary court). The sentence could be:

-126-

SECRET

SECRET

SECRET SECRET

- (1) complete rehabilitation and re-enlistment, (2) assignment to disciplinary units, (3) sentence to prison or a slave-labor camp, or (4) death.⁶⁸

Only two general categories of prisoners-of-war were interrogated by Smersh units:

- (a) All enemy agents apprehended by the Army or turned up by the surveillance net operated by Smersh. These agents were questioned on the methods and organization of the enemy secret service; in certain cases agents were suborned and sent back through the enemy lines as agents for the Soviets.
- (b) All prisoners of operational interest to the NKVD, that is, active members of Fascist organizations (such as the SS and SA), prominent enemy political personages, and personnel assigned to enemy intelligence services.⁶⁹

Interrogation of prisoners by Smersh began at division level since this was the lowest echelon at which Smersh maintained a unit headquarters with facilities for guarding and interrogating prisoners of war. Prisoners had been screened at battalion or regimental level, and those categories of prisoners which were of interest to Smersh were turned over to that organization upon their arrival at division headquarters. Such prisoners were seldom turned back to the Army for further exploitation by military intelligence sections. Spics and the more fanatical Nazis were often shot after they had been interrogated; prisoners who had been members of the elite Nazi troop units were usually sent to

-127-

SECRET

SECRET

SECRET SECRET

camps where conditions were even more rigorous than in the ordinary prisoner-of-war camps.

No official co-ordination of effort seemed to exist between a Smersh unit and the military intelligence unit of the same headquarters. Such co-operation as has been known to take place from time to time was probably on a personal basis between officials. For instance, it is known that Smersh officials sometimes called in military intelligence interrogators to assist in the interrogation of prisoners. Captured enemy agents who had been "twisted around" by the Smersh unit were often sent to the military intelligence section for briefing before being sent back to the enemy as agents for the Soviets. ⁷⁰ It is logical to assume that important tactical intelligence gathered by Smersh interrogators was passed on to the tactical commander. As a rule, however, the Smersh unit kept its findings secret from the military unit to which it was attached; at the same time, the Smersh unit kept an especially intensive surveillance over the personnel and activities of the intelligence section (the RU or RO) of the unit of which it was a part.

D. Summary

The interrogation of captured personnel in time of war normally takes place within the intelligence service of the armed

-128-

SECRET

SECRET

SECRET SECRET

forces of a belligerent. In the Soviet Union during World War II, however, the intelligence service of the Soviet Armed Forces was only one of several intelligence agencies involved in the exploitation of prisoners of war as sources of information. The reasons for this were inherent in the Soviet form of government.

The small clique headed by Stalin which rules the Soviet Union has maintained itself in power by ruthlessly stamping out all opposition. In order to discover opposition, the Soviet leaders have instituted one of the most intensive surveillance systems throughout the Soviet Union and its satellites that the world has ever known. This surveillance system operates even within the Politburo, the inner circle of the Communist party which actually governs Russia. One of the techniques of maintaining power, practiced by the ruling clique, is to foster rivalry, suspicion, and distrust between individuals who have been assigned overlapping responsibilities and between agencies which have overlapping missions. The Communist party actually functions as a huge counterintelligence agency, and its individual members, both in Russia and abroad, act as informers on each other and on nonmembers. From among the more trustworthy and fanatical of the party members, the Politburo has chosen personnel for its various intelligence and counterintelligence agencies. As a part of the "divide and rule" technique, no one agency has been

-129-

SECRET

SECRET

SECRET SECRET

permitted to gain complete control over one field of activity, and when any one organization has threatened to become all-powerful, reorganization and purges have been used to restore the balance of power.

Despite an elaborate pretense of decentralization of intelligence activities, the inner circle within the Politburo has carefully maintained its control over Soviet intelligence agencies at all times. Thus, as has been previously discussed, the Cheka became the OGPU; this, in turn, was incorporated within the NKVD as the GUGB; during the war the GUGB was separated from the NKVD to become the NKGB, but its surveillance functions over the Red Army were assigned to the GUKR NKO (Smerzh), a function shared to a certain extent by the Main Political Directorate of the NKO. The military intelligence agency of the armed forces, the GRU, was given a larger measure of independence during the war as a matter of military necessity (though it was still subjected to intensive surveillance). The system of checks and balances was so complex as to cause confusion among the Russians themselves concerning the spheres of authority enjoyed by various agencies of the Soviet secret service.

That Communist Russia has been continually engaged in a "class war" with all noncommunist nations and that this war will continue until the proletariat has triumphed and brought all

-130-

SECRET SECRET

SECRET SECRET

nations under the banner of Communism is a basic tenet of Soviet philosophy. Therefore, the operations of Soviet secret service agencies have always been directed to a greater or less degree, according to the type of agency, toward other nations as well as toward the population of the USSR. By nature of its mission, the Soviet military intelligence service directs its operations of military intelligence largely to the gathering of tactical information while the gathering of strategic information was delegated to a number of other agencies.

Soviet leaders maintain the strictest censorship and control over information about other countries which may be disseminated to Soviet citizens. Such information is collected and evaluated only by top-level governmental agencies, and dissemination of strategic intelligence is limited to a very few high-ranking military leaders who are given only enough data to enable them to accomplish their military missions.

Prior to World War II, the Soviet leaders had not been able to assert control over the Red Army to the degree exercised over most other Soviet institutions. This situation resulted, during the latter 1930's, in a purge of Red Army leaders which was especially severe in the military intelligence branch of the Soviet Armed Forces. When Germany invaded Russia in June 1941, the Soviet military intelligence service was weak,

-131-

SECRET SECRET

SECRET SECRET

inexperienced, and greatly restricted in its operations, and only dire military necessity forced Soviet leaders to give military intelligence sufficient authority to carry out its mission. Even with this additional authority, military intelligence still operated within severely defined limits, and the intensity of surveillance over its personnel and operations was increased. The Red Army as a whole managed to gain considerable freedom from political restraint during the course of the war; paradoxically, the Communist party emerged from World War II with a more firm control over the Red Army than ever before, largely accomplished by granting party membership to large numbers of Red Army personnel.

Because of the division of responsibilities between various intelligence agencies, Soviet interrogation of prisoners of war was carried out by several organizations, each of which was limited to a definite field of inquiry. Of these organizations, all of them except the military intelligence service were direct, though unofficial, agencies of the Communist party, and, significantly, these were the organizations which were permitted to gather strategic information.

In brief, the various Soviet intelligence agencies which engaged in the interrogation of captured personnel were as follows:

-132-

SECRET SECRET

SECRET SECRET

(1) Military Intelligence: Red Army military intelligence operations were directed by the Main Intelligence Administration (GRU) of the Peoples' Commissariat of Defense (NKO); the GRU was also the Second Division of the Red Army General Staff. Intelligence sections (RU's and RO's) were included on the staffs (shtab) of army groups (fronts), armies, corps, divisions, and brigades; the second assistant to the chief of staff of a regiment (PNS;-2) directed intelligence activities at that level, and the assistant commanders of battalions and companies assumed intelligence duties in addition to their other duties. Interrogation of prisoners, evaluation, and dissemination of intelligence were generally the responsibility of the information subdivision of an intelligence staff section. The various arms and services of the Red Army each had intelligence sections (RO's) which interrogated appropriate technical specialists among the prisoners. Prisoners were interrogated at each echelon of military command until they arrived at army level where they came under the jurisdiction of the NKVD. Military intelligence interrogators were required to confine their questions to matters pertaining to the immediate tactical situation. Above the level of army, only a very few of the more important prisoners were interrogated by military intelligence agencies.

(2) Counterintelligence: "Special surveillance sections" of the NKVD (OO NKVD) were attached to each headquarters of the Red Army down to the level of division until May 1943. At that time the units came under the jurisdiction of the Main Counterintelligence Directorate (GUKR NKO) of the Commissariat of Defense and were known as UKR (or OKR) NKO (Smersh) units. They continued to take directions unofficially, from the Commissariat of State Security (NKGB). Each Smersh unit was responsible only to the unit in the next higher headquarters and not to the commander of the military unit to which it was attached. The principal mission of Smersh was surveillance over Red Army personnel, but they interrogated certain classes of prisoners of war, particularly captured agents, enemy intelligence personnel, prominent political personages among the prisoners, and captured "political" troops (members of SS and SA units, et cetera). The army was required to turn such prisoners over to the Smersh units. Interrogation reports were sent to the Smersh unit of the next higher headquarters; there was no official co-ordination

-133-

SECRET SECRET

SECRET SECRET

of effort with the local military intelligence section.

(3) Main Political Directorate: Political sections, under the Main Political Directorate of the NKVD, were attached to Red Army headquarters at all levels of command down to and including division headquarters. Prisoners were subjected to exhaustive interrogations by members of the political staff, particularly on matters pertaining to the morale of enemy troops and to psychological warfare.

(4) Peoples' Commissariat of Internal Affairs (NKVD): All prisoners were turned over to the NKVD at army level. NKVD guard and escort troops evacuated prisoners to the zone of interior where all prisoner-of-war camps were under the jurisdiction of the Main Administration of Prisoner-of-War Camps of the NKVD. Exhaustive tactical, political, and strategic interrogations of prisoners were conducted in the camps by highly trained NKVD interrogation teams. The NKVD was responsible for the propagandizing of prisoners and for their exploitation as laborers. NKVD Border Troops and Security Troops in the Rear Areas of the Red Army had intelligence sections (RO's) which conducted interrogations of the limited number of prisoners captured by these semi-military units.

These were the principal Soviet agencies which conducted interrogations of prisoners of war. Also worthy of mention were the partisan units which were of great importance in the intelligence plan of the Red Army; these units sometimes exploited prisoners as sources of information, but little is known about partisan interrogations -- few prisoners survived capture by partisans to tell of their experiences.

By the end of the second year of the war between Russia and Germany, Soviet organization for the exploitation of prisoners as sources of information was extremely effective. While the

-134-

SECRET SECRET

SECRET SECRET

Red Army was somewhat restricted in the field of strategic intelligence, it was permitted sufficient opportunity to exploit prisoners for immediate tactical purposes. Despite the administrative difficulties, loss of time, and inefficiency inherent in the over-departmentalization which characterized the organizations of the various intelligence agencies, the extreme centralization of controls which existed in this totalitarian state permitted a maximum utilization of prisoner-of-war information once it had been collected from all sources and evaluated by the chosen few at the top of the governmental structure. What the system lost in the way of speed and efficiency was gained in the thoroughness of the interrogation procedure and the accuracy of deductions based on prisoner-of-war information.

-135-

SECRET SECRET

SECRET SECRET

CHAPTER VII

SOVIET REGULATIONS REGARDING
PRISONERS OF WAR

A. General

In keeping with the peacetime practices of all modern armed forces, the Soviet Army, prior to World War II, developed a body of regulations and procedures which were used in training and which were to guide the conduct of operations in time of war. General instructions on the capture, interrogation, and evacuation of prisoners of war were issued and appeared in various field and training manuals. Tables of organization provided for intelligence officers down to battalion level. These officers, as well as all line officers, had presumably (but not necessarily) been given at least elementary training in the technique of interrogation.

According to German sources, Soviet intelligence agencies, in specific preparation for the war with Germany, collected available German Army manuals, which were translated and distributed throughout the Red Army, in some instances as low as ¹ corps headquarters. They also conducted espionage in Germany, exchanged intelligence with the Czechoslovakian Army, and studied carefully their experiences of the Polish campaign.

Soviet theory, as set forth in the various instructions pertaining to interrogation before World War II, was at

SECRET SECRET

SECRET SECRET

considerable variance with actual practice in the early phases of combat. For instance, the instructions emphasized the importance of taking prisoners for purposes of interrogation, but the majority of Germans captured by the Red Army early in the conflict were killed, usually before questioning. It cannot be determined whether these killings were ordered by higher headquarters or were simply a manifestation of hate and of poor training in the lower echelons. In a number of individual instances various headquarters criticized interrogation results in lower echelons and issued orders prohibiting the killing of prisoners and the stealing of their personal effects. One thing is certain, however, the indiscriminate killing of prisoners was tolerated until the spring of 1942, if not longer. ² Similarly, Soviet intelligence preparation for war with Germany revealed a disparity between purpose and accomplishment. The file of German Army manuals generally was limited to material which had appeared before March 1939, at which time Czechoslovakia was occupied and Russia lost that country as a source of military intelligence. The Soviets exchanged very little, if any, information with the Western Powers and, consequently, were deprived of virtually all experience gained by the latter in the German campaigns against Denmark, Norway, and France. The Soviet program of espionage is believed to have been greatly curtailed

SECRET SECRET

SECRET SECRET

in Germany as a result of the complete suppression of the Communist party by the Nazis. While it can be assumed that the Soviet General Staff was aware of the experience gained in the field of prisoner interrogation during World War I and the Civil and the Russo-Polish Wars that followed, it is apparent that the Soviet high command failed to adequately train lower headquarters in known techniques and procedures.³ The great purges which took place from 1937 to 1939 particularly affected personnel in the intelligence services and on the General Staff of the Red Army. The majority was arrested, imprisoned and executed; others fled the country. Years of work in intelligence was thereby cancelled out, and the new intelligence service at the beginning of the war was weak and ineffective. The same was true, and for the same reason, of military leadership in general.⁴ Not until battle-tested leaders began to replace the incompetents in late 1941 did morale and discipline improve in the Red Army. Subsequent improvement of the Red Army as a fighting machine was paralleled by an improvement in interrogation techniques and by an increasing emphasis on the importance of interrogation as a means of gathering information.

B. Soviet Instructions Issued in 1940

A set of instructions concerning the collection, interrogation, and evacuation of prisoners (or deserters) was issued by the

SECRET SECRET

SECRET SECRET

Deputy Peoples' Commander of Defense in February 1940.⁵ The Germans found a copy of these instructions in Poland in the captured files of a Russian tank unit. This copy was one which had been issued by the Fourth (Soviet) Army to its subordinate units in September 1940, and it can be assumed, therefore, that the instructions were in force during the first stage of the conflict between Germany and Russia. The fact that the Germans captured a second copy of these instructions which had been received by the Trans-Caucasus Military District on 25 December 1941 supports this conclusion.⁶ Subsequent revisions of these instructions and specific orders regarding interrogation are available only in brief or fragmentary form, and most of the changes must be surmised on the basis of known changes in organization and procedure. Many of the 1940 instructions apparently remained in force, at least in principle, throughout the war, particularly as regards evacuation.

The 1940 instructions consisted of forty-nine articles followed by an appendix containing prisoner-report forms and questionnaires designed to serve as guides to interrogators in a variety of typical combat situations. In the discussion of these instructions which follows it will be noted that the procedures are similar to those practiced by the armed forces of most modern nations and that the directions given are very

SECRET SECRET

SECRET SECRET

general in nature. It will also be noted that none of the instructions prescribes procedures contrary to accepted rules of warfare, even though the Soviet Union was not a party to the Geneva (Prisoner of War) Convention of 1929. These instructions are not, of course, concerned with the treatment of a prisoner subsequent to his evacuation from the combat zone nor with his repatriation at the close of hostilities.

The first three articles of the instructions are subtitled "The Importance of Taking Prisoners." Articles 4 through 13 appear under the subtitle "Procedure for Collecting and Evacuating Prisoners"; articles 14 through 41 under "Interrogation of Prisoners"; and the last eight articles under "Evacuation of Prisoners."

The Importance of Taking Prisoners

At the beginning of the instructions it was emphasized that prisoners are a valuable source of intelligence to all levels of command and staff. A well-organized system of interrogation and of exploiting captured documents and materiel, it was stated, can lead to the formulation of accurate data on the strength, organization, and intentions of the enemy. Troops were urged to capture prisoners as frequently as possible since the taking of a prisoner is a clue, in itself, to the location of a certain enemy unit in an area; the taking of many prisoners can result in confirming the

SECRET SECRET

SECRET SECRET

presence of anything from a small unit to an army group.

Procedure for Collecting and Evacuating Prisoners

Immediately after capture, prisoners were to be disarmed and thoroughly searched for documents and concealed weapons. Unarmed soldiers were to conduct the search under the supervision of a commanding officer while armed soldiers kept loaded weapons pointed at the prisoners who stood with their hands raised. Officers and members of "military-bourgeois" organizations (such as SS units) were to be given an especially thorough search. Types of documents to be confiscated included orders, maps, official and personal correspondence, army manuals, diaries, notebooks, identification papers, and newspapers.

Article 13 of the instructions stated that "all military personnel . . . must be generous to an enemy prisoner and render any assistance in order to save his life." In keeping with this general rule, Soviet military personnel was specifically forbidden to take from or exchange with a prisoner the latter's gas mask, personal (toilet) kit, uniform, underclothing, footwear, belt, personal belongings, and money. Collection and search of prisoners during battle was to be carried out in terrain protected from enemy fire.

Following the search, prisoners, were to be subdivided into six groups: (1) officers, (2) noncommissioned officers and members

SECRET SECRET

SECRET SECRET

of "military-fascist" organizations, (3) privates, (4) deserters, (5) nonambulatory wounded prisoners, and (6) all others. Injured prisoners were to be evacuated through normal evacuation facilities or on stretchers borne by prisoners. All others were to be sent under guard from the company to the battalion collection point.

Preliminary interrogation of prisoners was to be made as soon as possible after capture and, in units from battalion level down, the information was to be noted only on field notebook interrogation forms which will be described in detail later in this discussion. Information on the prisoners -- number according to group, time and place of capture, designation of the enemy unit, and intelligence of an urgent nature -- was to be immediately reported to higher headquarters. Confiscated documents together with copies of the preliminary interrogation forms were to be sent by messenger or by vehicle as quickly as possible to the same higher headquarters.

Reconnaissance patrols or other army units operating far from their bases often cannot be burdened with prisoners nor can they spare guard personnel to evacuate them to the rear. In such cases it was directed that, after interrogation, the prisoners were to be turned over to local authorities of the nearest village. These authorities were to give a receipt for the prisoners and were responsible for transferring them to the nearest army command.

SECRET SECRET

SECRET SECRET

If this was impossible, the somewhat unrealistic instructions were given to release the prisoners -- after giving them a brief propaganda lecture and supplying them with "suitable literature." In such an instance, it was considered advisable for the capturing unit to release the prisoners after nightfall and then to change its position. Wounded prisoners, after being provided with necessary medical supplies, were to be left to the care of the local population.

Evacuation of prisoners was to be conducted by an escort commander, a junior officer if possible or a responsible enlisted man, and a guard escort selected according to the following general formula:

- a. For one prisoner -- two guards including the escort commander;
- b. For four to ten prisoners -- three to four guards;
- c. For larger numbers of prisoners -- guards not to exceed ten percent (10%) of the number of prisoners;
- d. At night and in wooded terrain increase the number of guards;
- e. For prisoners belonging to "military-bourgeois" organizations increase the number of guards;
- f. For a large number of prisoners the guard escort should include a "political worker" (politrobnik) and "political soldiers" (polit-boevets) to conduct political and intelligence activities among the prisoners.

The escort commander was to sign for the number of prisoners in the convoy according to a list of prisoners' names or, if

SECRET SECRET

SECRET SECRET

circumstances did not permit this, according to the number of prisoners in each group. The commander was to designate a senior member of each group of prisoners, one who spoke Russian if possible, to transmit orders to his group. An interval of two or three meters was to be maintained between groups during evacuation.

In a battle zone, the movement of prisoners to the rear was to be in covered terrain as much as possible, but halts in villages or wooded areas (where escapees would have cover) were to be avoided. During the evacuation of a large number of prisoners, two guards were to lead the way; the column was to be flanked with pairs of guards; the escort commander with a majority of the guards was to bring up the rear; and cocked weapons were to be held "in the right hands" of the guards at all times.

The escort commander was responsible for order among the prisoners who were not to be permitted to delay the march; to talk to other prisoners, the guards, or the local population; or to exchange objects among themselves. Propaganda talks were to take place only during rest stops. Open disobedience was to be dealt with by force. If one or two prisoners made a break for freedom, guards were to open fire and organize a pursuit. In case of mass disobedience or attempts at mass escape, the

SECRET SECRET

SECRET SECRET

escort was ordered to "take the same measures as in pursuit of the enemy."

Upon delivery of the prisoners at the assembly point of the higher headquarters, the escort commander was to secure a receipt for the prisoners, and this receipt was to be returned to the officer on whose order the prisoners had been transferred.

The foregoing exposition of the methods to be used in collecting and evacuating prisoners was based on Articles 4 through 13 of the 1940 instructions. Before going into a discussion of the instructions governing interrogation (Articles 14 through 41), the plan of evacuation as contained in Articles 42 through 49 will be summarized. These articles, aside from elaborating upon the evacuation procedure, gave directions concerning the organization of the prisoner assembly points at the various echelons of command where thorough and systematic interrogation of the prisoners was to take place.

The manner in which prisoners were organized and evacuated to the rear, stated the instructions, was conditioned by the necessity of interrogating prisoners at different levels of command and the further necessity of relieving troops in a combat zone of a superfluous and potentially dangerous responsibility. Evacuation of prisoners from combat areas was to begin immediately on the company and battalion levels in a manner

SECRET SECRET

SECRET

SECRET

which has already been described.

The Regimental Assembly Point. Detailed instructions were given concerning the location and the organization of the regimental assembly point. The location was to be selected by the regimental commander and under the supervision of his deputy chief of staff. The regimental chief of staff was to appoint a commander for this assembly point, normally an officer from the regimental reconnaissance company or an available officer from the regimental headquarters staff.

Only when there was a small number of prisoners could the regimental assembly point be located in the vicinity of the command post. When large numbers of prisoners were taken, the assembly point was to be located in the vicinity of the regimental staff's rear echelon headquarters. The point was to be outside the zone of effective artillery fire and camouflaged from aerial observation. It was forbidden, however, to locate the point in dense woods and underbrush. An escort and guard complement was to be assigned to man the assembly point, its strength dependent upon the expected number of arrivals.

Since prisoners were not expected to remain at the regimental point longer than from thirty minutes to an hour, no special organization of the ground was required except for the outfitting of premises (or tents), for those who were to be interrogated,

SECRET

SECRET

-146-

SECRET

SECRET

and the installation of a telephone connected with the regimental command post via the staff's second echelon headquarters. Prisoners arriving from lower levels came under command of the commanding officer of the assembly point, were to be signed for by him, and the escort guard was to be dismissed to return to its unit. The prisoners assembled here were to be reorganized into new formations, and a regimental guard escort was to be assigned to convey the prisoners to the division assembly point upon the orders of the regimental second echelon command post. Presumably, under ordinary circumstances, the commander of the assembly point could be under orders to keep all prisoners moving as quickly as possible to the division assembly point except for the few retained for a brief interrogation at this level.

The Division Assembly Point. The organization of the assembly point at division level was to be only slightly more elaborate than at regimental level. It was to be located in the vicinity of the division staff's second (rear) echelon headquarters. During a lull in operations when the division remained in the same position for some time, the area was to be surrounded with barbed wire. The division chief of staff was responsible for appointing a commander of the assembly point from among officers of the division headquarters company, the reconnaissance battalion, or other units according to the availability of personnel.

SECRET

SECRET

-147-

SECRET

SECRET

Administration of the point was the direct responsibility of the second assistant to the staff intelligence officer who was assigned the services of an interpreter. Assistants were to be assigned as needed from among officers of division headquarters. Provisions were to be made for furnishing bread and boiling water to the prisoners at this point, and a passenger vehicle and truck were to be made available to the commander. Assignment of guard and escort personnel, installation of communications, transfer of prisoners to the rear, and other matters were to be carried out in a manner similar to that prescribed at the regimental level.

The Corps Assembly Point. If a prisoner assembly point was established at corps level, instructions as to where it would be located and as to how it would be organized were almost identical to those given for the division assembly point. Command and administrative functions performed by division staff officers were to be performed by corresponding members of the corps staff except for interrogation, which here became the responsibility of the assistant chief of the intelligence section of the army general staff (that is, the army or army group conducting operations in that particular theater or "front"). From the corps assembly point, prisoners were to be moved to the rear under the command of the commander of the zone of communications as described below.

SECRET

SECRET

SECRET

SECRET

Movement to the Zone of Interior. If a division assembly point was near a main line of communications leading to the rear, corps was to be by-passed and prisoners were to be handed over directly to the commander of the zone of communications. This commander became responsible for furnishing guard personnel and supplies during this portion of the movement of the prisoners to the rear, but interrogation was to be the responsibility of army as at corps level. Following the main supply road of the line of communications, the prisoners were to be directed to prisoner-of-war collection points in the extreme rear of the army area (an area corresponding to the base section of the zone of communications at the extreme rear of a theater in the United States Army). These collection points, organized and supervised by agencies of the Peoples' Commissariat for Internal Affairs (NKVD), were to be located near a railroad in a railhead area. From here the NKVD, which operated all prison camps in the interior of Russia, was to dispatch the prisoners to permanent camps in the zone of interior.

Interrogation of Prisoners

Articles 14 through 18 of the instructions were subtitled "General Principles of Interrogation." The value of information obtained as a result of prisoner interrogation, so stated these regulations, depended on an interrogator's training and his technical skill. The interrogator must not only know the prisoner's

SECRET

SECRET

SECRET

SECRET

language but also enemy military organization and tactics and have a purposeful plan of interrogation based on the mission and on the intelligence plan of the capturing unit. All officers of the Red Army were to be prepared to conduct brief interrogations; only intelligence officers and military interpreters attached to headquarters staffs at the various levels of command were to conduct interrogations in detail. As a rule, a prisoner was to be interrogated only on questions of importance to the unit conducting the interrogation. Important information secured from a prisoner was to be transmitted as quickly as possible (by messenger, telephone, or radio) to the next higher headquarters.

Articles 19 through 22 were subtitled "Preparation and Conduct of Prisoner Interrogation." In preparing himself to conduct an interrogation, the interrogator was instructed to make preparations as follows:

- a. Gain a thorough knowledge of his unit's mission, of the general intelligence requirements arising from that mission, and of needed items of intelligence which prisoners could be expected to reveal.
- b. Make a thorough study of all available information on the enemy situation.
- c. Study the enemy terrain and prepare a map by marking points and areas of special interest to the interrogator.
- d. Confer with the political commissar and members of the political section concerning the carrying out of propagandistic and intelligence work among the prisoners.

SECRET

SECRET

-150-

SECRET

SECRET

- o. Prepare the assembly point to receive the expected number of prisoners and have present the necessary personnel to replace the escort guard of the unit delivering the prisoners.

Upon the arrival of prisoners at the assembly point, the interrogator was to carry out personally or to assign the following duties:

- a. Receive the prisoners, confiscated documents, and interrogation forms that may have already been completed and change the escort.
- b. Divide the prisoners into groups according to rank or category (as described under evacuation procedures) and conduct a search if this had not already been accomplished.
- c. Familiarize himself quickly with the interrogation sheets and documents concerning the prisoners.
- d. Determine in detail questions to be asked during interrogation.
- e. Report to higher headquarters the number of prisoners, the time and place of capture, and the unit (or units) of which the prisoners had been members.

If a large number of prisoners were received, the interrogator was to select several of the better-educated or more intelligent prisoners for questioning, keeping in mind that the most reliable information could be secured from prisoners belonging to the proletariat, from those who were of oppressed nationalities, or from Soviet sympathizers. Where there was only a small number of prisoners, all were to be interrogated.

After prisoners were selected to undergo interrogation, the others were to be sent immediately to higher headquarters; that is,

SECRET

SECRET

-151-

SECRET

SECRET

movement of the bulk of the prisoners to the rear was to be as rapid and continuous as possible.

Articles 23 through 35 of the instructions were subtitled "The Interrogation" and were concerned with general principles to be followed in conducting the actual questioning of the prisoner and with directions as to details which should be secured at the various levels of command. Sample questionnaire forms and lists of questions to be adapted to a variety of situations in the field were included in an appendix to the regulations and are also included in the appendix of this Study (Appendix I).

General principles to be followed in an interrogation were:

- a. Carry out an interrogation immediately after capture.
- b. Interrogate prisoners individually in isolated quarters.
- c. Take into consideration the individual characteristics of the prisoner, his social position, nationality, degree of intelligence, education, and willingness to talk. The interrogation period should not be one of strain or tension. Questions should be clear and simple. Answers should not be written down in the presence of the prisoner.
- d. Report any important information obtained during an interrogation -- the arrival of new enemy units, preparations for an attack or a retreat, the arrival or expected employment of any new weapons -- to the Chief of Staff who will immediately transmit it to the next higher headquarters by any means of communications available; also, dispatch the prisoner by the quickest mobile means to the same headquarters.
- e. Assist the prisoner by posing leading questions, but in no case should the interrogator have preconceived or prejudiced ideas and convey them to the prisoner.

SECRET

SECRET

SECRET

SECRET

f. Use a map during the interrogation, one used by the enemy and preferably of a large-scale; if necessary, the prisoner should be led to an observation point where information can be verified on the ground and made exact on the map.

g. Do not accept all statements made by a prisoner at face value without analysis. Every prisoner's testimony must be compared with information secured from other prisoners and from other available data. Do not contradict a prisoner or confront him with conflicting data.

h. Interrogate officers and noncommissioned officers in the same manner as other prisoners; the interrogator, however, should take into consideration their class status and their hostility to the Red Army and should expect refusal to answer or a tendency to give false information. It is, therefore, more practical to interrogate officers in higher headquarters (corps or above), with the exception of those who are willing to give information.

i. Remember that deserters are all more willing to give information, but their testimony should be treated with suspicion since there is always the possibility that they are enemy agents. Hence, the interrogator must try to discover the real reason for each desertion and carefully check the deserter's statements with other information.

The foregoing principles applied to the interrogation of military personnel. The instructions explained, however, that valuable information can often be secured from native inhabitants of an area in regard to the local terrain, road conditions, and the enemy (particularly after his retreat). When questioning civilians in such a situation, interrogators were instructed to select for questioning elements of the population socially close to the Red Army: laborers, farm-workers, and representatives of oppressed nationalities. They were to be questioned individually

SECRET

SECRET

SECRET

SECRET

and in an isolated place so that others, particularly the non-laboring classes of the community, would not know of the interrogation. Such questioning was to be informal and to be in the nature of a friendly chat.

When interrogating civilians, interrogators were instructed to:

- a. Separate facts actually seen by the inhabitant from those overheard, since the enemy might purposely be spreading false information.
- b. Bear in mind the incompetence of civilians in military matters, hence the possibility that they will exaggerate or depreciate the value of certain information.
- c. Take into consideration the fact that the information might be obsolete and check all times and dates carefully. Information gained from civilians should be compared with that obtained from other sources.

After completing an interrogation and before admitting another prisoner to the interrogation chamber, the interrogator was to write down immediately all statements made by the prisoner and to mark the necessary data on a map. Processed material together with remarks, conclusions, copies of interrogation sheets, and all documents were to be forwarded to the next higher headquarters, by the escort commander or by special messenger. This instruction applied only to regimental headquarters and higher. Interrogation sheets were to be used only in regimental and higher headquarters; field note-books were to be used for noting down information in

SECRET

SECRET

SECRET

SECRET

units from battalion level down.

The instructions also stated that in order to expedite the collection of information it might be necessary to detach an intelligence officer from a higher headquarters and assign him to a leading element where there was a large concentration of prisoners.

The last six articles (36-41) of the instructions pertaining to the technique of interrogation appear under the subtitle "Characteristics of Organization and Methods of Interrogation in Different Units (Company, Battalion, Division, and Corps)." This section begins with a statement to the effect that the foregoing directions for conducting an interrogation are applicable to all units and commands, and that variations occur only because requirements differ according to the combat situation and the mission of the unit or command.

Commanders of infantry sub-units (squads and platoons), of reconnaissance sub-units, and of other small troop units were authorized to conduct brief interrogations of prisoners only when their units were operating independently. These commanders were to ask only a few questions concerning the enemy: his location, disposition, strength, and intentions. Since interpreters would rarely be assigned to such small units, it was deemed necessary to have all essential questions written out beforehand in the

SECRET

SECRET

SECRET

SECRET

language of the enemy or to have at hand a concise "Russian-Foreign" military dictionary.

If a prisoner refused to identify his unit or if there was doubt concerning the correctness of the unit he named, the interrogator was to attempt to gain the information by an examination of the prisoner's uniform, insignia, or markings on the uniform and cap.

Prisoners captured by a small unit were to be questioned very briefly -- not more than ten minutes -- and a report of this interrogation (Appendix I, Form 1) forwarded without delay to the reports collection point (message center) or to the nearest headquarters. Brief interrogations of prisoners at this level were to be conducted only in the following instances:

- a. During independent operations;
- b. During a lull in offensive or defensive operations;
- c. When single prisoners were captured and in all cases when the combat situation permitted.

Such interrogations were for the purpose of ascertaining the mission of the prisoner's unit; that unit's location and activities; its numerical designation and the larger units to which it belongs; other units the prisoner had met in the area and when; the existence of artillery and tank units, their number and locations.

If it were impossible to deliver a prisoner to the rear, either because he was wounded or because of the situation, the

SECRET

SECRET

SECRET

SECRET

interrogation was to be in more detail. This information which would be of value to the next superior officer was to be reported to him immediately.

When a large number of wounded were captured, they were to be mustered by the First Sergeant of the company and sent to the battalion assembly point under an escort. Otherwise, normal evacuation procedures, as previously described, were to be observed.

A short interrogation of prisoners could take place at battalion level when circumstances permitted. Here the interrogator was to be the adjutant or any other officer designated by the battalion commander. During tense moments of battle, especially during an attack or pursuit of the enemy, only selected individual prisoners were to be questioned. Restrictions on the amount and kind of information that was to be secured at company level applied at battalion except, of course, that the interrogation would cover questions of interest on a battalion level. Prisoners arriving at battalion from company were to be divided into groups by the adjutant or by a commander from a company of the rear echelon. After strengthening the escort from the battalion reserve, they were, if necessary, to be directed to the regimental assembly point.

Interrogation of prisoners at regimental level was to be more

SECRET

SECRET

SECRET

SECRET

detailed than at battalion, but the extent of the detail was to depend on the situation and type of battle. Interrogation here was to be conducted by the second assistant chief of staff (PNSH-2). During an advance or an offensive operation, transfer of prisoners to the rear was to be as rapid as possible and with a minimum of interrogation. Procedures in this situation were to be:

- a. Reception of prisoners and their documents and replacement of the escort guard.
- b. Search and grouping of the prisoners (if this had not already been accomplished) and a hasty examination of documents.
- c. Determination of enemy unit, time and place of capture, and the selection of individuals for interrogation.
- d. Immediate transfer of prisoners to division.
- e. Report (by telephone or message) on the number of prisoners, time and place of capture, and designation of enemy units to next higher headquarters. (For models of interrogation forms see Appendix I, Forms 2 and 3.)

During lulls in combat operations, interrogation of prisoners at regimental level was to be much more thorough in accordance with the directions given for detailed and carefully prepared interrogations.

At division and corps level the interrogation of prisoners was to be carefully planned and executed as described in the instructions. (For examples of questionnaires at this level, see Appendix I, Forms 4 and 5.)

SECRET

SECRET

SECRET

SECRET

C. Red Army Adherence to Instructions Concerning Prisoners

The number of Germans captured by the Russians early in the war was very small (a retreating army takes few prisoners), and those taken were often killed on the spot. Even during the fairly successful counter-offensives in the winter of 1941-42, few prisoners were taken. A number of factors contributed to the reasons why Russian troops refused quarter or killed most German prisoners at the beginning of the conflict: For twenty years the idea had been drilled into the Russian soldiers that only in the Soviet Union were to be found freedom and respect for human rights and that the capitalistic nations, especially Germany, would eventually try to destroy the liberty of the Russian people; Communist propaganda constantly hammered into the Russian people that they had been treacherously attacked; a desire for revenge was generated by both real and imagined atrocities committed by the Germans; the troops lacked proper training and discipline, they were ignorant of their own regulations, and they lacked any real appreciation of the value of prisoners as sources of intelligence and as labor. These and other reasons led the Russian troops to commit numerous well-authenticated atrocities against German prisoners. Whether this was a basic policy of the Soviet Government in regard to prisoners is still a debatable question.

SECRET

SECRET

SECRET

SECRET

Even after the value of "live" prisoners was established and discipline had improved, the Soviet high command had difficulty in preventing the indiscriminate killing of prisoners. As late as 1944 German soldiers who had escaped Russian captivity told of occasional killings of prisoners, particularly of the wounded, and of one instance in which two German officers were shot on orders of a regimental commander because the Germans refused to answer questions. In another instance, occurring in June 1944, fifty German prisoners were killed by their ten partisan guards who, in turn, were shot by a Red Army general after the latter had conducted a brief investigation on the spot. Intoxicated Russian soldiers were often responsible for atrocities against prisoners.⁹

The few prisoners whose lives were spared during the early stages of the war were apparently processed and interrogated according to the 1940 instructions. Very few of the prisoners taken during the first months of the war, however, survived the rigors of the years of imprisonment that followed, and, consequently, there is little authentic information available from German sources on prisoner interrogation during that period.¹⁰

In addition to the frequent killing of prisoners, many other 1940 instructions were ignored or violated. Throughout the war, prisoners were nearly always stripped of personal possessions,

SECRET

SECRET

-160-

SECRET

SECRET

from boots and underwear to watches and eyeglasses. Far from being free from "strain or tension," interrogation periods were characterized by table pounding, pistol-point threats, and physical brutality when prisoners refused to answer questions satisfactorily. Red Army interrogators also contradicted prisoners frequently during interrogations and confronted them with conflicting data, practices which had been specifically forbidden in the 1940 instructions.

While the killing of prisoners was tolerated by lower echelon commanders, it would appear that the Soviet high command disapproved from the beginning. A directive (No. 1798) of the Soviet Government, dated 1 July 1941, reiterated humanitarian aspects of the 1940 instructions and categorically ordered: "It is prohibited to insult and maltreat prisoners."¹¹ A general order issued in December 1941 revealed that the supreme command was dissatisfied with interrogation results, that it censured military personnel because so few prisoners ever arrived at army headquarters for interrogation and prohibited the killing of prisoners by combat troops.¹² An order of the VIII Cavalry Corps (Russian), dated December 1942, stated: "In compliance with the Order of the Commanding General of the Fifth Tank Army [Russian], I order that all German officers and enlisted men who surrender are to be treated well. . . . The wounded will be given medical care."¹³

SECRET

SECRET

-161-

SECRET

SECRET

As noted earlier in this study, a Russian officer captured by the Germans in March 1943 stated that during his seven-month tour of duty with a corps headquarters, his commanding general had issued several orders which directed troops not to shoot prisoners but to bring them to corps headquarters for interrogation.¹⁴ The Germans, naturally, assailed all such orders as false propaganda designed to induce desertions from the German ranks.

The victory at Stalingrad in 1943 marked a turning point in the treatment of German prisoners. On 8 July 1943, Stalin issued Order 171 to which frequent reference was subsequently made in both Russian and German propaganda. Order 171, as paraphrased and summarized in a German document, was alleged to be as follows:

In order to prompt German soldiers to desert in increasing numbers, orders are issued to the effect that every prisoner of war is to receive especially good rations and treatment. Prisoners of war are to be examined with regard to their fascist convictions, and those, who are not convinced fascists, are to be returned to their own lines after a brief period of time. These returnees are to spread tales to the effect that treatment of German prisoners is exceptionally good and that nobody is shot. They are to attempt at the same time to subvert their own troops. Those Russians who do not comply with this order are to be brought before a military tribunal.¹⁵

Neither the need for information nor humanitarian motives were fully responsible for the many orders prohibiting the killing and mistreatment of prisoners. Russian war industry rested primarily on slave labor, both domestic and foreign. With the

SECRET

SECRET

SECRET

SECRET

loss of much territory and of millions of workers and troops to the Germans early in the war and with the further draining of manpower from industry into the armed forces, Russia's domestic supply of both "free" and slave labor could not meet industrial needs. Hence emphasis was placed on taking larger numbers of prisoners alive and well.¹⁶

As previously stated, Russian views of international law permitted the ruthless exploitation of prisoners as labor even to their assignment to strictly military projects, such as carrying ammunition to the front lines and clearing mine fields. The Russians, it must be noted, treated prisoners of war no less brutally than they did their own people who had been sentenced to hard labor in penal or "labor" camps.¹⁷

The German High Command's memorandum known as Hitler's "Commissar Order" recommended that political Commissars attached to Red Army units should not be recognized as prisoners of war but should "be liquidated in transient prisoner-of-war camps at the very latest."¹⁸ This gave an excuse (if one were needed) for later Soviet measures which discriminated against members of the Nazi Party, SS and SA, and other Nazi political functionaries who fell into Soviet hands. Other Nazi pronouncements regarding the invalidation of rules of warfare so far as Russia was concerned resulted in Russian reprisals against German prisoners and in

SECRET

SECRET

SECRET

SECRET

almost complete deterioration of international law between the
19
two powers.

D. The 1942 Soviet Field Regulations

Only four paragraphs of the Soviet Field Service Regulations issued in 1942 were concerned with the interrogation of prisoners of war. Of these, one dealt exclusively with methods of confirming and evaluating information obtained from prisoners and captured documents. ²⁰ As usual, the Russians emphasized the fact that prisoners and deserters were one of the most important sources of information about the enemy.

When a group of prisoners arrived at a headquarters, they were to be grouped according to their particular units and with officers separated from enlisted men. At the regimental level the interrogation was to be brief and the results entered on special interrogation sheets. Upon completion of the interrogation the prisoners were to be sent to division headquarters, together with the interrogation sheets and the documents which had been taken from them.

Interrogation at division and corps headquarters was to be conducted by the Chief of the Intelligence Branch (staff section) after he had examined the interrogation sheets that had been forwarded from lower headquarters. At each level, interrogation

SECRET

SECRET

-164-

SECRET

SECRET

was to be concerned only with information pertaining to the reconnaissance (intelligence) plan of that particular headquarters. Regardless of the level, results of interrogation were always to be forwarded to the next higher headquarters.

All captured documents -- particularly field orders, maps, and documents of the field coding service and ciphers -- were to be forwarded to higher headquarters immediately.

Directions were given carefully to examine prisoner and documentary information in the following manner:

- a. Compare incoming reports with information already on hand and with records of previous enemy activities.
- b. Check the extent to which the new data confirms suppositions and evaluations regarding the enemy.
- c. Determine the reliability of the information.
- d. Appraise the information in relation to the task on hand and to the situation of our troops.
- e. Set apart the most important information.
- f. Evaluate the situation and the nature of enemy actions at the time of receipt of the information.
- g. Determine further reconnaissance tasks.
- h. Compile all information revealing the actual situation and intentions of the enemy and summarize it periodically.

If any doubts arose as to the reliability of information, it was to be verified immediately, either by the dispatch of fresh reconnaissance units or by assigning the task to a unit already

SECRET

SECRET

-165-

SECRET

SECRET

in the field. Information received from agents, deserters, and local inhabitants was always to be verified unless confirmed by data obtained from other sources.

Apart from the specific directions concerning the evaluation procedure, it should be noted that the directions given neither changed nor conflicted in any essential detail with the 1940 instructions. The instructions, however, were extremely brief, leaving the impression that more complete directions for interrogating prisoners were issued separately.

E. Subsequent Orders and Directives

While many of the basic principles of evacuation and interrogation of prisoners as contained in the 1940 instructions and the 1942 regulations probably remained in force throughout the war, the spring of 1942 saw a reorganization of the interrogation system. This period was the beginning of the second phase of the war and, as has been noted, prisoners had become valuable, both as sources of information and as laborers. The peoples' Commissariat for Internal Affairs (NKVD), as the traditional agency responsible for espionage and counterintelligence, began to usurp more and more prerogatives in the matter of interrogating prisoners while intelligence agencies of the armed forces were subordinated to a minor role in this field. ²¹ A progressive step was taken by

SECRET

SECRET

SECRET

SECRET

formulating "long-range" or strategic estimates of the situation and of the enemy's intentions in one intelligence organization only. The Army suffered a disadvantage in being virtually eliminated from the strategic interrogation program, although it still had considerable opportunity to secure valuable tactical information from prisoners in the field. Strategic intelligence was disseminated sparingly, and military leaders at all levels of command were told only as much about the over-all situation ²² as was necessary for them to know to carry out their missions.

The actual directives which brought about the reorganization of the interrogation system were not available at this writing, but assumptions can be made on the basis of known changes in organization and methods. Actual practices of interrogators and the functioning of the new system will be delineated later in this study. Here, however, are noted some of the general effects brought about by the reorganization:

- a. Uniformly trained and oriented interrogation personnel were made available throughout the Soviet armed forces.
- b. Emphasis in interrogation was shifted from troop units to prisoners-of-war camps.
- c. Intelligence targets were broadened and extended to include long-range tasks (e.g., gathering information in the field of military economy; preparing prisoners to carry out missions of insurrection and sabotage.)

SECRET

SECRET

SECRET

SECRET

d. Field headquarters of the Red Army down to and including division level were staffed with NKVD interrogators (later transferred to Smersh.)

e. Interrogations were carried out according to a standard pattern.

f. Information from all sources (including prisoner-information) was collected at a central agency where it could be properly compared and evaluated.

g. Evaluated information was channelled to both the supreme command and troop units.²³

The new system apparently worked well and with increasing success until the end of the war. Despite the disadvantages suffered by the Army, the latter was still able to secure vital combat intelligence of immediate value to an operation below divisional level in the same manner as before. At higher levels, it profited from the findings of the NKVD even though a less bureaucratic system might have disseminated even more available information useful to commanders in the field.²⁴

Better organization and more successful results in the field of interrogation did not necessarily mean that the lot of prisoners improved. The need for masses of workers plus better discipline in the Army resulted in a cessation of the indiscriminate slaughter of captives, but careless evacuation procedures plus bad conditions in the prison camps resulted in the deaths of thousands of Germans. In addition, German prisoners were now often subjected to the third-degree tactics of NKVD interrogators.

SECRET

SECRET

-168-

SECRET

SECRET

Since prisoners were needed for labor, the supreme command from time to time made strenuous efforts to improve conditions. One such effort was contained in Order No. 001 issued by the People's Commissar of Defense on 2 January 1943.²⁵ This order began with a long list of defects which had been observed in the evacuation of prisoners from the fronts and ended with twelve paragraphs of instructions which, if enforced, would certainly have resulted in humane, not to say generous, treatment of prisoners. Since this order made no reference to interrogation, no further discussion of the text will take place here, but it has been included in the appendix as an example of the disparity that often existed between Russian directives in regard to prisoners and actual practices. (See Appendix II, Item 1.)

This particular order did not entirely succeed in its purpose as a Russian Special Order captured by the Germans in mid-1944 indicates.²⁶ This latter order, issued by the commanding general of a Russian division, stated in part, ". . . To this date, violations of order . . . 001 . . . still occur among the troop units of the Division. As a rule, prisoners are held too long at the regimental headquarters. . . . There have also been additional instances of depriving prisoners, in contravention of orders, of valuables, clothing, and footwear. . . ." The general ordered a speedier flow of prisoners to the rear, forbade the

SECRET

SECRET

-169-

SECRET

SECRET

stealing of prisoners' personal possessions, and ordered the use of scouts as guard-escort personnel to be discontinued. (See Appendix II, Item 2.)

F. Political Interrogation Directives

Separate treatment will be made later in this study of the methods employed in conducting "political" interrogations, but a brief discussion of the one political interrogation directive available is appropriate at this point.

All thought and activities of the Russians were (and still are) characterized and dominated by the political ideology of Communism, often to the detriment of military operations. It will have been noted in the previously discussed directives regarding the handling of prisoners that frequent mention was made of class distinctions. Even in interrogations at company level on the battlefield an attempt was usually made to establish the social origin of each prisoner. The political propagandizing of prisoners began almost at the moment of capture and never ceased thereafter.

A document entitled "Directive Concerning the Political Interrogation of Captured Enlisted and Officer Personnel" was captured from the Russians by the Germans early in the spring of 1944. This directive, dated 3 October 1941, had been issued

SECRET

SECRET

-170-

SECRET

SECRET

by the Main Political Directorate of the Peoples' Commissariat of Defense. ²⁷ (Appendix III, Item 1.) The opening sentence of the directive is significant: "From the moment of his capture by the Red Army and during the entire duration of his captivity, the enemy enlisted man (officer) must be under continuous indoctrination by political workers."

The basic objectives of this indoctrination were:

- a. To discover, unmask, and isolate fascist elements;
- b. To arouse class consciousness and to reeducate along antifascist lines the soldiers who were deceived by Hitler and his henchmen;
- c. To round up soldiers of antifascist conviction and to give them a comprehensive political indoctrination.

The political interrogation of prisoners of war was to pursue the following objectives:

- a. To ascertain the political and moral attitude of interrogated personnel;
- b. To ascertain the political and moral condition of the unit in which the prisoner served;
- c. To determine the type of ideological training which the soldiers had received as well as the subject matter of such training and the topics used in discussion;
- d. To obtain information on the effect of Russian propaganda and on antifascist activity among the enemy's /frontline/ troops and the army rear area.
- e. To indoctrinate the prisoner morally and politically, as to unmask fascism and arouse sympathies for the Workers' Council among the elements which were socially akin;

SECRET

SECRET

-171-

SECRET

SECRET

f. To collect material and information which might be important to Russian propaganda efforts directed at the enemy's troops and population.

Political interrogations were to be carried out on division, army, and army group levels in the field. It was preferable that the interrogator be a linguist; if necessary, an interpreter could be used, but no other personnel was to be present at an interrogation. Wounded prisoners were to be questioned briefly; upon recovery, they were to be subjected to complete interrogation by prisoner-camp commissars. Interrogations were always to be individual and oral. Written statements elaborating on one question or another were to be requested from a prisoner only after verbal interrogation had been completed.

When groups of prisoners were taken, officers and enlisted men were to be separated immediately in order to prevent the officers from influencing the enlisted men. The latter were to be interrogated first, then the noncommissioned officers, and finally the officers. The social background of the prisoner was to be taken into consideration when conducting an interrogation. A questionnaire form attached to the directive (Appendix III, Item 2) was to be used in interrogating German enlisted men and noncommissioned officers up to and including the rank of Feldwebel (platoon sergeant) who had a labor or farm background. Interrogators were to make appropriate changes when questioning prisoners

SECRET

SECRET

-172-

SECRET

SECRET

from higher social levels or non-German prisoners, such as Austrians or Poles. Members of the SS and military police (Feldgendarmarie) were to be asked supplementary questions. (The Russians may have meant the secret field police rather than the military police, a possible mistake in the German translation of the Russian document.)

The interrogator was to follow this questionnaire form provided for political interrogations and to do his utmost to obtain complete information. Important prisoners were to receive a correspondingly more thorough questioning. Interrogations were to be conducted in such a manner that the dignity of Wehr Army interrogators would be preserved. No familiarity was permitted between prisoner and interrogator.

A written record (protocol) was to be made of each separate interrogation. It was to be detailed; generalizations were to be omitted. In order to prevent mistakes, names of prisoners, geographical names, and similar data were to be written in the prisoner's language as well as in Russian. The prisoner's arguments regarding basic political questions (especially arguments against the fascist regime and Hitler's policies) were to be recorded with particular care as well as every fact which testified to the disintegration of the political and moral structure of the German Army and of the civilian population in Germany.

SECRET

SECRET

-173-

SECRET

SECRET

Each record of an interrogation was to be clearly dated and signed by the interrogator. These records were then to be collected by the branch officer of the political section at army level and forwarded first to the political directorate at army group level and from there to the Main Political Directorate in Moscow. A copy of each interrogation record was to be sent to the commander of the transit camp where the prisoner was kept while awaiting assignment to a permanent camp. A picture of each prisoner was to be taken which would show the prisoner in a clean and well-groomed condition, if possible, and which was to be included with the record of his interrogations. On the back of the picture was to be noted the prisoner's name, his military unit, date of interrogation, and the number of the record of the interrogation.

Documents coming into the hands of the political directorate at army group level were to be sent to the Main Political Directorate of the NKO (i.e., letters, diaries, photographs, orders, directives, newspapers, and magazines). If possible, notation was to be made of the source of each document, and, if from a prisoner, his name, organization, date of capture, and civil occupation were to be written on the document.

Attached to this directive concerning political interrogations was a paraphrased version (compiled by the German

SECRET

SECRET

-174-

SECRET

SECRET

translator) of the subject matter covered by the questions an interrogator was to ask a prisoner. Fortunately, another copy of this "Guide for the Political Interrogation of Prisoners" was found by the Germans among the papers of a dead commissar after the battle of Kharkov in May 1942.²⁸ The German version of this document is obviously a literal translation of the guide (rather than a paraphrase) and has been reproduced in Appendix III, Item 2. It consists of 142 questions under five general headings: I. General Data; II. German Armed Forces (Wehrmacht); III. Conditions in the ZI; IV. Political Attitude and Convictions of the Prisoner; and V. Attitude Toward Soviet Propaganda. These questions were designed to probe out details ranging from the sex life of soldiers at the front and how they spent their pay to the prisoner's personal attitude toward the Hitler regime, the Russian people, and the Soviet Government. Since the document appears in the Appendix, no further discussion of it is needed here.

G. Summary

The few available Soviet regulations regarding prisoners of war prescribed, on the whole, common-sense procedures similar to those practiced by most modern armies. Prisoners were to be evacuated from the front lines to the rear as rapidly as possible. Interrogation at the front was to be brief and concerned only with questions of immediate tactical value. Exhaustive

SECRET

SECRET

-175-

SECRET

SECRET

interrogations for strategic and "political" purposes were to be carried on by higher echelons of command in the rear where information could be properly collated, evaluated, and disseminated.

Known regulations did not conflict with accepted rules of warfare and usually prescribed humane procedures. There was a wide gap, however, between prescribed procedures and actual practices. But after the spring of 1942 the need for information from prisoners and the need for large numbers of prisoners as workers resulted, indirectly, in the more humane treatment of prisoners.

Most Soviet regulations regarding prisoner evacuation and interrogation procedures issued after 1942 must be surmised on the basis of known practices. It is known that the Peoples' Commissariat of Internal Affairs (NKVD), a para-military organization, had taken over many of the interrogation functions of the Red Army and had completely usurped the strategic interrogation program by mid-1942. Greater emphasis was put on "political" interrogation at this point. Political interrogation consisted largely of a meticulous gathering of all kinds of information from a great many prisoners with the two-fold objective of converting the prisoner to communism (or of determining his potentialities as a convert) and of formulating strategic concepts of enemy

SECRET

SECRET

SECRET

SECRET

capabilities, intentions, and morale. Army intelligence agencies were free to gather only combat intelligence of immediate tactical value. Soviet interrogation methods and procedures, by the end of the war, were efficient and successful with only minor defects resulting from bureaucratic over-centralization of the system.

SECRET

SECRET

SECRET

SECRET

CHAPTER VIII

SELECTION AND TRAINING OF
INTERROGATORS AND INTERPRETERS

A. Interrogation Personnel

Interrogation of prisoners was the specific responsibility of intelligence officers in the Soviet armed forces. Many routine interrogations were conducted by enlisted interrogators and interpreters assigned to intelligence units or headquarters sections. All Soviet commissioned officers, however, were expected to be able to conduct interrogations if necessary. Unit commanders, particularly those of the combat echelons in the front lines, frequently questioned select prisoners in order to obtain direct information on matters of immediate tactical interest.

Within the Red Army there was no Intelligence Corps, as such, but intelligence officers could be drawn from any branch of the service. Some officers were undoubtedly selected to specialize in intelligence and accordingly, were given advanced schooling in this specific branch of the service; others, particularly those assigned to this duty in the lower echelons, were probably chosen from normal staff and regimental sources for tours of duty in intelligence. ¹ Membership in the Communist party was a desirable but not essential qualification for an individual selected to

SECRET

SECRET

SECRET

SECRET

serve in the Soviet intelligence service; however, before assignment to such duties, his loyalty and political reliability were always carefully investigated.

At the beginning of the war with Germany, the intelligence service of the Red Army lacked an adequate number of trained and experienced personnel because of the aforementioned great purges of 1937-39. It may be assumed, therefore, that very few Soviet intelligence officers or interpreters on duty in June 1941 had received specific training in the technique of interrogation. Many German prisoners, however, talked freely to their Soviet captors, and the need was not so much for trained interrogators as for personnel skilled in collating and evaluating information obtained from prisoners.

The tables of organization for intelligence staff sections provided for interpreter personnel at nearly all levels of command. The German language had been taught in all secondary schools and junior colleges of Russia as a compulsory subject; many Jews in Russia were able to speak German; and German immigrant colonists spoke German as their mother tongue. Although it is doubtful that many of this latter group were trusted to serve as intelligence personnel, a large pool of interpreters speaking fluent German was available in the Soviet armed forces at the beginning of the war. If no German interpreter could be found in a lower unit of a

SECRET

SECRET

SECRET SECRET

combat command, the next higher echelon could easily provide qualified personnel by arranging an internal transfer. Interpreters of languages other than German, however, were not nearly so available.²

Ability to speak the language of the enemy, including technical phraseology and slang, is only one of many accomplishments required of an interrogator or an interpreter assigned to military intelligence. He should, among other things, be a well-trained soldier; know his unit's tactical objectives and intelligence plan; be intimately familiar with the enemy's military organization, tactics, order of battle, equipment and rank insignia; and be possessed of an alert mind with the ability to adapt his method of interrogation to the personality of the prisoner being questioned. Very few Soviet interrogators and interpreters could meet these requirements in June 1941, but by the end of the second year of the war a large number had been trained in hastily established schools (or in concentrated courses in previously existing institutions), and their skills had been polished with much practical experience in the field. At least a part of the military interpreters and interrogators received training in NKVD institutions.³

Interrogators of the NKVD conducted most of their political and strategic interrogations in prisoner-of-war camps where they

SECRET

SECRET

SECRET SECRET

were organized as interrogation teams, one team to one or more prison camps. Other members of the NKVD conducted a limited number of interrogations in the field where they were assigned to the "special surveillance" teams, the OO NKVD. This personnel continued to perform the same duties when the OO NKVD became the OKR NKVD Smersh in 1943, and all personnel assigned to the latter organizations were drawn from the ranks of the NKVD or the NKGB rather than from the armed forces. All NKVD and NKGB personnel were members of the Communist party, well trained and disciplined, and fanatically energetic in carrying out their duties.

According to former German prisoners of the Soviets, the strategic interrogation program in the prisoner-of-war camps did not begin until the spring of 1942. Apparently the NKVD was not prepared or had not planned to undertake the prisoner interrogation program at the beginning of the war.⁴ The NKVD was a state security and counterintelligence organization. At the beginning of the war many members of the NKVD were already highly trained and experienced interrogators, but their training had been in the field of counterintelligence rather than military intelligence, and their interrogations had been directed at domestic suspects rather than at prisoners of war. During the course of the conflict, however, the NKVD trained a large number of interrogators who, according to former German prisoners, "were not only exceedingly well trained

SECRET

SECRET

SECRET

SECRET

in Soviet interrogation methods, but also possessed a surprisingly detailed knowledge on all sorts of military, technical, and industrial subjects.⁵"

B. Selection and Training of Intelligence Officers

Great care was exercised by the Soviets in selecting military intelligence personnel, especially for those who were to occupy key positions. Before the war only politically reliable regular army officers and administrative officials were chosen, but during the war requirements were considerably lowered, especially for those in subordinate positions, because of the necessary expansion of military intelligence.⁶

The selection of individuals to occupy lower positions in the military intelligence service, chiefs of the RO's of corps and divisions or heads of subordinate sections in RU's, was based on the political reliability of the candidate as revealed by a security check by the Main Counterintelligence Administration (GUKR) and on the individual's general capabilities and military efficiency. Candidates who met requirements were sent to intelligence courses (Kursy Razvedchikov) lasting from three to six months in special camps near Moscow.

Key intelligence personnel selected to hold positions as chiefs of RU's and as section chiefs of the GRU were thoroughly

SECRET

SECRET

SECRET

SECRET

checked for their political reliability by the GUKR; a desirable but not essential qualification was membership in the Communist party. Candidates who met requirements were sent to the College of Intelligence (Vyskaya Shkola Razvedki) in Moscow which for purposes of camouflage was called the Preparatory School for Staff Officers (Uchilishche Priqotovki Komandirov Shtabnoi Sluzhby). The high requirements necessary for assignment to this institution are demonstrated in captured orders of the 90th Guard Infantry Division issued to one of its regiments on 31 May 1943, parts of which are quoted here:

According to instructions from NKO of 19 April 1943, there are three courses for training intelligence officers at the Special Academy of the Red Army. The following requirements are necessary for persons willing to register for the class in 1943:

a) 1st Course . . . Complete political reliability, high school degree, and graduation from military academy, not less than two years' service in staff headquarters as a battalion commander, age up to 32 years. Voluntary application and the desire to devote oneself to intelligence work are prerequisites.

b) 2d Course . . . Same requirements as for 1st Course, but in addition, practical experience in the work of one of the various intelligence units, and advanced military academy training.

c) 3d Course . . . Same requirements as for 2d Course plus additional experience in work with various intelligence organizations. . . . The Division Commander orders a careful selection of people who meet the requirements. . . . A list of the selected candidates plus life history and character references from the last military organization in which they served, as well as party statistics of their political reliability are to be submitted by 1 June 1943 to the 4th Division of the Divisional Staff.⁷

SECRET

SECRET

SECRET

Before the war the period of training lasted from one and a half to two years, but during the war the courses were simplified and the length of training was allegedly reduced to one year. The number of students in each of the three courses was apparently limited to between 50 and 100 officers, but scholastic and other requirements were so high that often only twenty percent of the class was graduated. A wide variety of subjects was taught at this institution as can be seen in the following program of instructions:

- History of the Soviet Secret Service
- Various means of gathering intelligence
- The hiring of agents
- Installation of an agency
- Building up of residencies [Establishing an informer network]
- Communications
- Reporting
- Preparing forged documents
- Enemy counterintelligence
- Secret Service [Espionage] abroad
- Basic doctrines of Marx and Lenin
- History of the Communist Party
- Political and economic geography
- Photographic technique
- Organization of the Red Army and of important foreign fronts
- Practical experience in the Secret Service [Espionage]
- Field experience, that is, supervised work in the field; procurement of items of intelligence or of documentary value.

Final training for high ranking intelligence officers was received in the Second Faculty of the Academy of the General Staff (Akademiia Generalnogo Shtaba). Suitable officers from the rank of captain to colonel attended this school before assignment to

SECRET

-184-

SECRET

SECRET

leading positions in military intelligence. The four-year prewar course was cut to one year at the beginning of the war and then increased to two years in 1943 (broken by a four months' assignment in command of troops). About 600 officers were said to have received training in this school in 1941. During the war, two courses were presented simultaneously to about 150 students, one course being a year ahead of the other. Of these students, about twenty or thirty a year were selected for permanent assignment in the intelligence service. In this school, advanced general training was given in higher military command and intensive instruction was given in all fields of military intelligence with special attention to foreign armed forces.

Available information on the subject matter of the courses for higher ranking intelligence officers indicates that more emphasis was placed on espionage than on strictly military intelligence training. It can only be assumed that more attention was devoted to combat intelligence techniques during the war. While no specific references to training in the technique of interrogation have been noted, it is logical to assume that this important phase of intelligence received due consideration in the long, intensive courses given at these higher institutions.

Officers of the military intelligence service have enjoyed high prestige in the Soviet Union, but their careers have been

SECRET

SECRET

-185-

SECRET

SECRET

difficult. Reliability of personnel is the foundation of a secret service, and Communist leaders have taken stringent measures to insure this reliability. On one hand, honors, awards, and privileges have been heaped on successful intelligence officers; and on the other, they have been kept under the strictest surveillance at all times. (During World War II, Smersh units, as one of their principal missions, kept the personnel of military intelligence staff sections under especially close surveillance.) Intelligence personnel who have gained influence and power beyond their assignments have disappeared in favor of capable but less dynamic personalities. They have been shifted constantly from one position to another in order to prevent an undue growth of prestige as well as to provide opportunity for broad experience. The smallest infraction of security or hint of disloyalty has led to arrest and imprisonment.

The circle of officials deemed trustworthy and responsible by Soviet leaders has been very limited, and those leaders have been especially fearful that information about conditions in other countries would undermine the loyalty even of carefully selected military intelligence officers. Hence, during World War II, the military was not permitted to conduct strategic or political interrogations of prisoners of war. Only the NKVD, as a more trusted agency of the Communist party, was delegated the task

SECRET

SECRET

-186-

SECRET SECRET

of learning from prisoners the truth about conditions in their native countries, and such information was available only to the inner circle of leaders of the Soviet Union.

C. Training in the Field

A Soviet captain who had been assigned to an infantry division as commanding officer of a reconnaissance battalion was captured by the Germans in July 1944. A month before his capture he had attended a three-day course for intelligence officers in the vicinity of Smolensk, of which one lecture hour had been devoted to prisoner interrogation. The lecture had been given by the Chief of the Research Branch of the Intelligence Directorate of the Western Front and was accompanied by a demonstration interrogation. German interrogators secured a complete report from this Soviet officer concerning the lecture and demonstration. ¹⁰ Since it is the only such report available, it has been included as Appendix IV of this study.

Methods of interrogation as described by this Soviet captain were conventional and will be delineated in the section of this study devoted to actual interrogation procedures. Understandably, the prisoner emphasized that Soviet interrogation was conducted in a humane, even friendly, fashion and that prisoners were in no way mistreated, although he indicated that narco-sis was used with prisoners at higher headquarters. The effective part played

SECRET

SECRET

-187-

SECRET

SECRET

by stool pigeons and medical personnel in securing information by indirect and deceptive methods was emphasized in this report.

Notable here is the fact that officers in the field were given systematic, practical training from time to time in order to keep them abreast of current techniques and directives and to improve the quality of officer personnel who could not be spared from the lines for longer courses of instruction in the zone of interior.

D. Soviet Air Force Intelligence Officers

Before the war, Regular Air Force Officers normally received a four-year course of instruction at the Military Academy, a course which was reduced to two or three years during the war. After 1941, increased emphasis was placed upon intelligence and reconnaissance in the Frunze Academy in Moscow (the Advanced Infantry School). Graduates of the Voroshilov Academy (the Advanced Staff School) were thought to be ready for assignments as chiefs of intelligence sections of the staffs of military districts, armies, and army groups, or for positions as chiefs of the various branches of the Intelligence Directorate (GRU). (Regular officers of both the Red Army and the Red Air Force probably had more or less identical training in this respect.)

A limited number of air force intelligence officers with a background of practical experience were sent to continuation courses

SECRET

SECRET

-188-

SECRET

SECRET

for staff specialists for one year. Such schools existed in Tbilisi, near Tiflis, and in Tashkent. Graduates of the Air Force Military Academy in Tachkalov were also sent to these continuation courses.

Intelligence officers of air regiments did not receive any special training, but only particularly capable officers were chosen for these positions. They were given instructions by the intelligence officer of the air division who called the regimental officers together for conferences at periodic intervals. Regimental staff officers of extra merit were frequently promoted to higher echelon staff positions in intelligence.

E. NKVD Interrogation Personnel

Members of the NKVD (and the NKGB) selected for high-ranking posts in the organization underwent even more careful investigation and had to meet higher requirements in regard to reliability than military intelligence officers. Before taking final training at the Advanced School in Moscow, candidates for higher positions in the organization had to complete several short courses and successfully fulfill their subordinate assignments. Before the war the course at the Advanced School lasted two years, but during the war it was apparently reduced to six or eight months. Those completing the course were given the rank of Lieutenant or Captain of State Security.

SECRET

SECRET

-189-

SECRET

SECRET

All NKVD members were also members of the Communist party and were under severe pressure at all times to devote their full energies to fulfilling their responsibilities. High ranking officials of the NKVD were under even greater pressure. Mistakes, lack of attention to duty, infractions of security, the slightest hint of disaffection or lack of loyalty were not tolerated but were severely punished. On the other hand, these officials, as long as they remained in favor, enjoyed high prestige and exercised dictatorial powers within the limits of their assignments.

NKVD (and NKGB) officials holding intermediate and subordinate positions attended short training courses of about three months' duration before receiving their appointments. They were required to have some experience in espionage or counterespionage before attending a school. Courses in these schools consisted of the usual political indoctrination subjects (the doctrines of Marx, Lenin, and Stalin and the history of the Communist party), a study of various counter-revolutionary and espionage systems of foreign countries, investigation procedures (interrogation), criminal law, agent operations, and apprehension procedures.¹³

As has been noted, the NKVD inaugurated numerous short courses during the war for the training of interrogators and interpreters. A limited number of officers of the unit intelligence sections and interpreters on the lower levels of the Red Army were also

SECRET

SECRET

SECRET SECRET

permitted to attend these courses. Apparently, the NKVD was quite successful in turning out capable interrogators and interpreters¹⁴ although details are lacking on the courses of study taught in these schools.¹⁵

F. Selection and Training of Interpreters

As has been noted, the Soviets had a large number of German interpreters available at the beginning of the war, but this personnel had neither special training in the technique of interrogation nor special knowledge in the field of military intelligence. The NKVD, likewise, had a large pool of interpreters and interrogators available, but both categories of personnel had been trained for and had experience in domestic counterintelligence rather than in gathering positive military information.

Both the Army and the NKVD took steps to remedy the military interpreter situation by establishing many schools and conducting short courses to improve the quality and usefulness of the interpreter personnel. Little has been learned about the NKVD schools, but several reports are available on the Military Institute of Foreign Language.

At the beginning of the war, the Red Army utilized a civilian Institute of Foreign Languages in Moscow for the training of military interpreters and translators, but the pressing need for large

SECRET

SECRET

SECRET

SECRET

numbers of such personnel led to the founding of a Military Institute of Foreign Languages under the supervision of GRU. In late 1941 or early 1942 the institute was evacuated from Moscow and divided into two faculties, the Eastern Faculty being moved to Fergana (Turkestan) and the Western Faculty to Stavropol in the District of Kuibyshev (on the Volga). The Stavropol branch concentrated at first on short courses in order to turn out quickly much needed German interpreters; it was also delegated the task of preparing men for future (postwar) duties requiring specialized linguistic abilities. A captured Soviet officer who had attended the Stavropol school gave his interrogators the following data on this school which has been supplemented with information gathered¹⁶ by United States Army intelligence agencies in Europe since the war.

The Stavropol Institute offered a complete three-year course and several special courses of instruction lasting from six to ten months. The school facilities as of October 1943 permitted an enrollment of 1,500 students for the three-year course and from 200 to 250 enrollees in the short courses. Many of the students admitted to the school came from Moscow, sons and daughters of the new "aristocracy" of Russia -- that is, high officials in the government and high-ranking officers of the army. In other words, a certain amount of influence was needed to gain admission at the school. Most of these students had some preliminary knowledge of

SECRET

SECRET

SECRET

SECRET

German.

The course for interpreter-interrogators offered at the Stavropol Institute prepared individuals for duty at division level in the Red Army. At this level they were required to have the following accomplishments:

- a. Be able to interrogate prisoners of war;
- b. Be able to exploit captured documents (determination of a prisoner's unit by examination of his pay-book, interpretation of abbreviations, etc.) and to recognize important military data contained in documents;
- c. Have a thorough knowledge of German Army tables of organization, equipment, rank insignia, and other specialized matters necessary for the performance of an interrogator's duties.

At the Institute the following subjects were taught with each student specializing in one foreign language (hours indicated are the number of class-hours per eight-month term):

- a. Languages (phonetics, grammar, linguistic exercises) -- 900-950 hours;

English	Finnish	Bulgarian
German	Rumanian	Serbian
French	Hungarian	
Italian	Polish	

(All students were required to take a 70-hour course in Russian.)

- b. Economic Geography (of that country whose language was being studied) -- 70 hours;
- c. Organization and Armament of the German Army (the various branches of service) -- 500-520 hours;
- d. Interrogation of Prisoners of War -- 140 hours;

SECRET

SECRET

SECRET

SECRET

c. History of the Communist Party -- 140 hours.

Note that graduates of this course received considerable training in the technique of interrogation along with their language study, an indication that interpreter-interrogators (as distinguished from intelligence officers) were expected to conduct a considerable part of the prisoner-interrogation program.

The daily schedule at the school consisted of classes for eight hours and individual preparation and study for four hours. In addition, students were required to serve on guard details and to perform routine housekeeping duties such as kitchen police, chopping wood, and gardening or farming on the collective farms. After successfully completing the course, the student received the rank of "Administrative Technician, 2nd Class," (a commissioned officer rank.)

Another account of language training in the Red Army, a postwar report based on the interrogation of a Soviet deserter who attended the school for a short course in 1945 and again from 1946 to 1948, is dealt with briefly here. (See Appendix V for excerpts of this report.)

According to the Soviet deserter, the Eastern Faculty in Turkestan did not begin operations until late in 1942. This school offered courses in the Chinese, Japanese, and Turkish languages only, but otherwise had the same organization and purpose as the

SECRET

SECRET

SECRET

SECRET

Western Faculty. Late in 1943, both Western and Eastern Faculties were united and moved to a permanent installation in a suburb of Moscow (Lefortova).

In 1945, the Moscow Institute had four faculties (corresponding to colleges in an American university) and the course of instruction lasted a minimum of four years. The school was operated by the Ministry of the Armed Services (MVS) and while most of the students were selected from the Army, civilians and individuals from various other branches of government in the USSR were permitted to attend. Most graduates were assigned to duty with the armed forces, but they could be assigned to many branches of the government other than the military. In 1948, between 2,000 and 2,500 students were enrolled in the school, all of whom wore military uniforms. They held the rank of "special student" (slushatel) during the first two years of the course, became junior lieutenants at the beginning of the third year, and were commissioned lieutenants upon graduation. The informant stated that military intelligence officers other than interpreters and interrogators studied foreign languages in other schools.

It was characteristic of the Soviets to make use of women in a great number of positions not ordinarily occupied by women in the armed forces of the Western Powers. Many Russian women in uniform were employed as both interrogators and interpreters, even

SECRET

SECRET

SECRET

SECRET

in forward echelons of the combat units, thereby releasing men
18
for the actual fighting.

G. Summary

At the beginning of the war, Soviet intelligence services suffered from the lack of trained and experienced personnel as interrogators and interpreters. There were plenty of German interpreters, but they were unskilled in military intelligence methods. After the first year of the war, there was a steady improvement in Soviet intelligence methods as trained and uniformly oriented personnel were made available by the armed forces and NKVD schools. As the war progressed, both interrogators and interpreters became experts on the German Army, on conditions in Germany, and on military intelligence matters in general. In the prisoner-of-war camps, particularly, NKVD interrogation teams were staffed with fluent linguists possessed of a surprisingly detailed knowledge of German military and civilian affairs and well acquainted with all aspects of gathering and evaluating prisoner-of-war information.

Intelligence personnel in the armed services and members of the NKVD who interrogated prisoners were carefully selected and had to meet rigid political, mental, and personal standards before being assigned to the intelligence services. This personnel

SECRET

SECRET

-196-

SECRET

SECRET

underwent difficult and well-rounded courses of instruction in special schools. Some of these schools were in existence before the war; many more were established during the conflict. Courses of instruction ranged from "refresher-courses" of two or three days' duration to full college courses lasting four or five years. Many Russian women were employed both as interrogators and interpreters, even in the front lines.

SECRET

SECRET

-197-

S E C R E T

CHAPTER IX

S E C R E T

INSTRUCTIONS FOR SOVIET CAPTURED PERSONNEL
AND TREATMENT OF REPATRIATED PRISONERSA. Indoctrination and Training

Except for a few of the older men, Red Army soldiers who fought in World War II had been subjected to Communist propaganda all their lives, but after entering the Army they endured an even more intense program of indoctrination than ordinary Soviet citizens. Political commissars attached to each unit were responsible for this aspect of troop training. It was their mission to maintain high morale and to produce soldiers who were fanatically loyal to the Soviet Union and its leaders. Most commissars were brave and intelligent, and although fanatical and unscrupulous their powerful influence in the Red Army was not achieved entirely by terroristic methods. The commissars were often more aggressive than the officers in providing for the general welfare of the men, and their acts of self-sacrifice and bravery frequently inspired respect. The Germans noted that last-ditch stands by Red army units were often made under the inspired leadership of commissars rather than officers. German commentators also have remarked that political commissars were an important and necessary part of the structure of the Red Army because of the passive character of most Russians.¹

A basic tenet of the Communist creed which was constantly drilled into the Red soldiers was that all non-Communist nations

S E C R E T

S E C R E T

-198-

S E C R E T

S E C R E T

were the implacable enemies of the Soviet Union and were seeking to destroy it. (Even Russia's "capitalistic" allies during the war were the target of a subtle propaganda program). Against the Nazi-led German invaders the Soviets unleashed an especially bitter campaign of hate. In the propaganda directed at the Red Army, the Communist leaders constantly reiterated the fiction that Germans shot all prisoners on the spot, a fiction believed by most Red soldiers.² At the beginning of the German offensive, Soviet plane crews who had parachuted from their planes after being hit were among the first prisoners taken. According to German witnesses, these prisoners "with bitter hate, or, in individual cases, with uncontrolled sobbing, awaited their fate: they expected to be shot. . . . They became all the more confused when the Germans treated them in a friendly manner."³

Soviet soldiers were instructed, as a foremost principle to be observed, not to permit themselves to be captured; they were to fight to the death if necessary. This injunction was accompanied by the warning that they would suffer death, anyway, at the hands of the Germans. It was emphasized that capture was shameful and reprehensible, and the soldiers knew that if they fell into enemy hands (or deserted) they would suffer investigation or court martial upon repatriation and that their families would probably suffer reprisals.⁴ On the other hand, the Soviets "extolled the virtues

S E C R E T

S E C R E T

-199-

SECRET

SECRET

of the soldier who committed suicide rather than surrender."⁵

As though rather grudgingly admitting that some soldiers might fall into enemy hands through no fault of their own, the Soviets did give a minimum number of positive instructions for behavior if captured. These instructions emphasized two points: (1) Soviet soldiers were to destroy all maps, papers, and documents before imminent capture, and (2) they were to maintain absolute secrecy about all military matters.⁶

Following the non-aggression pact with Germany in August 1939, Soviet propaganda had, to a certain extent, extolled the virtues of the Germans. This program backfired in the early days of the war when surprised and confused Russian soldiers surrendered by the thousands to the German invaders. Even at that time, however, many Red Army units stood their ground and were annihilated. Characteristically, the Soviets switched their propaganda program overnight from one of praise to hate. Even more effective in stiffening resistance were the acts of atrocity committed by the Germans, their treatment of Russian prisoners and peoples in occupied areas, and their invasion of the motherland of the Red soldier who had a deep-rooted love for that land quite apart from the loyalty inspired by Communist propaganda. During the first part of the war, therefore, and especially as long as professional soldiers manned the defenses, there were countless instances where

SECRET

SECRET

-200-

SECRET

SECRET

Red soldiers fought to the death when they could have surrendered. Later in the war, according to German observers, they were not so willing to sacrifice their lives in hopeless situations, but upon capture were still terrorized because of the propaganda about German treatment of prisoners.

Instructions for maintaining secrecy and destroying papers produced poor results from the Soviet point of view. While a few Soviet prisoners refused to reveal military information in their possession despite threats or promises, the greatest majority of them talked freely -- even eagerly -- to their captors. As for papers and maps, German observers have stated, "The Russian prisoners also volunteered to show maps and other military papers which they carried; frequently one even gained the impression that they had intentionally refrained from destroying some papers in order to make a favorable impression on the interrogators -- a notion which especially appeals to primitive men."⁷

The Russian's fear of betrayal by his comrades, inspired by the Soviet system of surveillance, made it necessary for German interrogators to question Soviet prisoners singly. Only then would the prisoner talk freely without fear of future denunciations. In the presence of superiors, comrades, and especially the political commissars the Soviet prisoner would say nothing.

SECRET

SECRET

-201-

SECRET SECRET

Information obtained from Soviet prisoners was found by the Germans to be reliable and accurate and Soviet military personnel proved co-operative when treated well. Deserters were always available for interrogation on all sectors of the German Eastern Front.⁸ Except for routine information concerning their duties, however, most Russian prisoners knew little about Red Army plans or affairs because of the stringent security practices which prevailed in the Soviet Union. Important information could be secured, as a rule, only from officers on the highest levels of the field army and planning staffs and from political commissars.⁹ Naturally, few such prisoners were taken.

B. Treatment of Repatriated Soviet Prisoners

The Soviet attitude toward members of their armed forces who were taken prisoner was demonstrated at the close of the war with Finland. These prisoners were repatriated in railway cars marked "Traitors to the Fatherland" despite the fact that many of them had been captured by the Finns after they had been wounded in battle. All of them were convicted of crimes against the Soviet Union (the charge was usually "passive defense of the fatherland"), sentenced to terms of from eight to fifteen years in prison, and sent to concentration camps in Siberia.¹⁰

SECRET SECRET

SECRET SECRET

Despite repeated attempts by the International Red Cross Committee, the United States, and other powers to persuade the Soviet Union to adhere to the provisions of the Geneva Convention of 1929 regarding the treatment of prisoners of war, the Soviets refused to make any commitments in that respect. Germany had announced a willingness to apply the provisions of that convention on a reciprocal basis, but when the Russians refused to co-operate, the Germans, understandably, declared themselves free of any obligations and refused to permit the inspection of Soviet prison camps by neutral observers.¹¹

Most nations in time of war are concerned about the fate of their people who fall into enemy hands and, hence, are willing to exchange lists of prisoners' names with the enemy through neutral agencies, provide for the sending of relief parcels to their personnel in enemy prison camps, and arrange for an exchange of prisoner mail. The Soviets indicated their attitude toward Red soldiers who had surrendered to the enemy by displaying complete indifference on all these matters. Even when certain of the western Allies offered to ship relief supplies to Soviet prisoners in Germany, the Soviet Union refused the necessary co-operation to make the shipments possible.¹²

It has already been noted that all Russians who had escaped encirclement, who had been trapped behind enemy lines, or who had

SECRET SECRET

SECRET

SECRET

escaped from enemy capture and had returned to Russian lines were treated with great suspicion and were immediately interrogated by personnel of the Smersh units. Soviet citizens in areas occupied by the Germans often volunteered their services or were pressed into service in the German Army as auxiliary volunteers (Hilsswillige or "Hiwi"). When captured by the Russians, these individuals were often shot on the spot or else were in danger of being shot by their guards or by passing Red Army soldiers as they were being conveyed to the rear.¹³

Returned soldiers who claimed that they had escaped from capture as bona fide prisoners of war were taken back into the ranks only after a long period of investigation in special camps. Those found guilty of traitorous conduct were "liquidated." An officer often lost his rank upon his return to the Russian lines but was permitted to regain it by proving his worth and loyalty in battle.¹⁴ Many officers and enlisted men had to clear themselves of suspicion by exemplary conduct in "penal" battalions which were considered "expendable" and were forced to take part in actions in the most dangerous sectors of the front lines.¹⁵ After World War II, returned Soviet prisoners were sent to forced labor camps as convicted criminals following their repatriation.

In the Soviet Instructions to Red Army personnel there was a definite implication that surrender was considered the equivalent

SECRET

SECRET

SECRET

SECRET

Despite repeated attempts by the International Red Cross Committee, the United States, and other powers to persuade the Soviet Union to adhere to the provisions of the Geneva Convention of 1929 regarding the treatment of prisoners of war, the Soviets refused to make any commitments in that respect. Germany had announced a willingness to apply the provisions of that convention on a reciprocal basis, but when the Russians refused to co-operate, the Germans, understandably, declared themselves free of any obligations and refused to permit the inspection of Soviet prison camps by neutral observers.¹¹

Most nations in time of war are concerned about the fate of their people who fall into enemy hands and, hence, are willing to exchange lists of prisoners' names with the enemy through neutral agencies, provide for the sending of relief parcels to their personnel in enemy prison camps, and arrange for an exchange of prisoner mail. The Soviets indicated their attitude toward Red soldiers who had surrendered to the enemy by displaying complete indifference on all these matters. Even when certain of the western Allies offered to ship relief supplies to Soviet prisoners in Germany, the Soviet Union refused the necessary co-operation to make the shipments possible.¹²

It has already been noted that all Russians who had escaped encirclement, who had been trapped behind enemy lines, or who had

SECRET

SECRET

SECRET

SECRET

escaped from enemy capture and had returned to Russian lines were treated with great suspicion and were immediately interrogated by personnel of the Smersh units. Soviet citizens in areas occupied by the Germans often volunteered their services or were pressed into service in the German Army as auxiliary volunteers (Hilsswillige or "Hiwi"). When captured by the Russians, these individuals were often shot on the spot or else were in danger of being shot by their guards or by passing Red Army soldiers as they were being conveyed to the rear.¹³

Returned soldiers who claimed that they had escaped from capture as bona fide prisoners of war were taken back into the ranks only after a long period of investigation in special camps. Those found guilty of traitorous conduct were "liquidated." An officer often lost his rank upon his return to the Russian lines but was permitted to regain it by proving his worth and loyalty in battle.¹⁴ Many officers and enlisted men had to clear themselves of suspicion by exemplary conduct in "penal" battalions which were considered "expendable" and were forced to take part in actions in the most dangerous sectors of the front lines.¹⁵

After World War II, returned Soviet prisoners were sent to forced labor camps as convicted criminals following their repatriation.

In the Soviet Instructions to Red Army personnel there was a definite implication that surrender was considered the equivalent

SECRET

SECRET

SECRET

SECRET

Despite repeated attempts by the International Red Cross Committee, the United States, and other powers to persuade the Soviet Union to adhere to the provisions of the Geneva Convention of 1929 regarding the treatment of prisoners of war, the Soviets refused to make any commitments in that respect. Germany had announced a willingness to apply the provisions of that convention on a reciprocal basis, but when the Russians refused to co-operate, the Germans, understandably, declared themselves free of any obligations and refused to permit the inspection of Soviet prison camps by neutral observers.¹¹

Most nations in time of war are concerned about the fate of their people who fall into enemy hands and, hence, are willing to exchange lists of prisoners' names with the enemy through neutral agencies, provide for the sending of relief parcels to their personnel in enemy prison camps, and arrange for an exchange of prisoner mail. The Soviets indicated their attitude toward Red soldiers who had surrendered to the enemy by displaying complete indifference on all these matters. Even when certain of the western Allies offered to ship relief supplies to Soviet prisoners in Germany, the Soviet Union refused the necessary co-operation to make the shipments possible.¹²

It has already been noted that all Russians who had escaped encirclement, who had been trapped behind enemy lines, or who had

SECRET

SECRET

SECRET

SECRET

escaped from enemy capture and had returned to Russian lines were treated with great suspicion and were immediately interrogated by personnel of the Smersh units. Soviet citizens in areas occupied by the Germans often volunteered their services or were pressed into service in the German Army as auxiliary volunteers (Hilswillige or "Hiwi"). When captured by the Russians, these individuals were often shot on the spot or else were in danger of being shot by their guards or by passing Red Army soldiers as they were being conveyed to the rear.¹³

Returned soldiers who claimed that they had escaped from capture as bona fide prisoners of war were taken back into the ranks only after a long period of investigation in special camps. Those found guilty of traitorous conduct were "liquidated." An officer often lost his rank upon his return to the Russian lines but was permitted to regain it by proving his worth and loyalty in battle.¹⁴ Many officers and enlisted men had to clear themselves of suspicion by exemplary conduct in "penal" battalions which were considered "expendable" and were forced to take part in actions in the most dangerous sectors of the front lines.¹⁵

After World War II, returned Soviet prisoners were sent to forced labor camps as convicted criminals following their repatriation.

In the Soviet Instructions to Red Army personnel there was a definite implication that surrender was considered the equivalent

SECRET

SECRET

SECRET

SECRET

Despite repeated attempts by the International Red Cross Committee, the United States, and other powers to persuade the Soviet Union to adhere to the provisions of the Geneva Convention of 1929 regarding the treatment of prisoners of war, the Soviets refused to make any commitments in that respect. Germany had announced a willingness to apply the provisions of that convention on a reciprocal basis, but when the Russians refused to co-operate, the Germans, understandably, declared themselves free of any obligations and refused to permit the inspection of Soviet prison camps by neutral observers.¹¹

Most nations in time of war are concerned about the fate of their people who fall into enemy hands and, hence, are willing to exchange lists of prisoners' names with the enemy through neutral agencies, provide for the sending of relief parcels to their personnel in enemy prison camps, and arrange for an exchange of prisoner mail. The Soviets indicated their attitude toward Red soldiers who had surrendered to the enemy by displaying complete indifference on all these matters. Even when certain of the Western Allies offered to ship relief supplies to Soviet prisoners in Germany, the Soviet Union refused the necessary co-operation to make the shipments possible.¹²

It has already been noted that all Russians who had escaped encirclement, who had been trapped behind enemy lines, or who had

SECRET

SECRET

SECRET

SECRET

escaped from enemy capture and had returned to Russian lines were treated with great suspicion and were immediately interrogated by personnel of the Smersh units. Soviet citizens in areas occupied by the Germans often volunteered their services or were pressed into service in the German Army as auxiliary volunteers (Hillswillige or "Hiwi"). When captured by the Russians, these individuals were often shot on the spot or else were in danger of being shot by their guards or by passing Red Army soldiers as they were being conveyed to the rear.¹³

Returned soldiers who claimed that they had escaped from capture as bona fide prisoners of war were taken back into the ranks only after a long period of investigation in special camps. Those found guilty of traitorous conduct were "liquidated." An officer often lost his rank upon his return to the Russian lines but was permitted to regain it by proving his worth and loyalty in battle.¹⁴ Many officers and enlisted men had to clear themselves of suspicion by exemplary conduct in "penal" battalions which were considered "expendable" and were forced to take part in actions in the most dangerous sectors of the front lines.¹⁵ After World War II, returned Soviet prisoners were sent to forced labor camps as convicted criminals following their repatriation.

In the Soviet Instructions to Red Army personnel there was a definite implication that surrender was considered the equivalent

SECRET

SECRET

SECRET

SECRET

of desertion which, of course, is considered traitorous conduct by all armies. The NKVD took measures in 1942 to take reprisals against relatives of all known to have committed treason; therefore, no Soviet prisoner could be sure that his family was safe.¹⁶

Soviet distrust of any citizen who has been in any other country has been so great that Soviet troops on completing occupational duties in countries of western Europe have been, according to various reports, immediately interned in camps upon their return to Russia. There they have been discharged from the army, the waywardness of the capitalist countries visited has been explained to them, and then they have undergone an intensive course of Soviet indoctrination for six months. After that, they have been assigned to labor groups throughout Russia and kept under close surveillance. (They usually found that their families had been split up among other labor groups.) Those showing evidence of having been tainted with capitalistic ideology have been assigned to forced labor battalions.¹⁷

During the war, the Germans transported groups of thousands of Russian citizens to Germany to serve as slave laborers. Upon repatriation, these groups were not permitted to return to their homes but were put in internment camps and required to perform hard labor. The Soviets considered these people dangerous because they had seen too much of the western way of life.¹⁸ Also, Soviet

SECRET

SECRET

SECRET

SECRET

leaders for many years have had to invent pretexts to seize thousands of citizens for slave labor in Soviet industry and this was an excellent excuse.¹⁹

Many Soviet prisoners had to be forcibly repatriated to Russia because of their well-founded fear of punishment upon return. A Russian colonel, a member of a screening team sent to the United States to trace former Soviet soldiers who had by accident (or design on the part of the prisoner) been imprisoned in camps with German prisoners, expressed the Soviet attitude toward prisoners who had allowed themselves to be captured by saying to them, "You are nevertheless considered guilty for having become prisoners. . . . If you do not wish to return -- we will do to you -- we will -- we will cover you with shame."²⁰ (According to the interpreter's report, the dashes indicate angry pauses made as an obvious threat.)

C. Summary

Soviet armed forces personnel were instructed to fight to the death rather than to permit themselves to be captured. The virtues of the Red soldier who did so were extolled, and the soldier who did not was condemned as having committed an act of disloyalty approaching treason. Furthermore, the story that Germans killed all prisoners was constantly reiterated.

SECRET

SECRET

SECRET

SECRET

Recognizing the fact that Red soldiers would, nevertheless, be taken prisoner, they were instructed to destroy all maps and documents in their possession before imminent capture and, upon capture, to maintain silence on all military matters when interrogated.

Soviet instructions in this regard were not effective. While many Red soldiers fought to the death when they could have surrendered, the Germans captured literally millions of Soviet troops. These troops, upon capture, talked freely to their interrogators, and the Germans considered them a reliable and valuable source of information.

The Soviets renounced Red Army personnel who had been taken prisoner. If they escaped back to their lines or were recaptured during the war, they usually had to redeem themselves by loyal service in penal battalions, and these units were considered expendable in battle. Families of Red soldiers taken prisoner often suffered reprisals. Practically all Soviet prisoners repatriated at the close of the war were condemned to hard labor in forced labor camps.

SECRET

SECRET

SECRET

SECRET

CHAPTER X

SOVIET METHODS OF INTERROGATING
GERMAN PRISONERS OF WARA. Phases of Prisoner Treatment

According to former German prisoners of the Soviets, there were five distinct phases or stages in Soviet methods of handling prisoners during and after the war. These five phases were:

- Phase I: 22 June 1941 (Beginning of War between Germany and Russia) to Spring of 1942.
- Phase II: Spring of 1942 to February 1943 (Stalingrad).
- Phase III: Stalingrad to August 1945 (End of War).
- Phase IV: End of War to Autumn 1947 (Four Power Agreement on Prisoners of War. This period can be called the "Punishment Years.")
- Phase V: Fall of 1947 to Present (1950).¹

Phase I was characterized by the lack of an effective military intelligence organization for the exploitation of prisoner-of-war information and by extreme brutality on the part of the Russians. Most of the few prisoners taken were destroyed, often in a bestial manner, and the few interrogations that took place were usually conducted in a superficial manner by combat personnel. Prisoners who survived capture were evacuated to prisoner-of-war camps which were under the supervision

SECRET

SECRET

-208-

SECRET

SECRET

of the Red Army.² Of significance is the fact that no prisoners taken during the first stage of the war are known to have been repatriated to the western zone of Germany since the war, the implication being that not even the strongest could survive four or five years imprisonment under the rigorous conditions imposed on German prisoners in the camps.³ Few interrogations took place in prisoner-of-war camps during this stage; apparently no camp interrogation program had been organized. There are a few recorded instances, however, of the extensive interrogation of some German officers who had been taken prisoner late in 1941.⁴

Prior to the war, Red Army doctrine had emphasized the importance of prisoner interrogation, and there is no evidence that this doctrine was temporarily abandoned or suspended so far as the Soviet high command was concerned. The indiscriminate killing of prisoners and the failure to properly exploit prisoners as sources of information during this stage of the war can be attributed to several factors. Among these were lack of preparation and training, lack of a sufficient number of trained intelligence officers and interpreters, the general demoralization and lack of discipline in the retreating Red Army, the fierce hate for the Nazis generated in the individual Red soldier by propaganda and by the invasion of his native land, and both real and imagined atrocities committed by the Germans. By the end

SECRET

SECRET

-209-

SECRET

SECRET

of 1941, however, it is certain that the high command was ordering considerate treatment of prisoners and had expressed dissatisfaction with interrogation results.

Phase II was characterized by a growing awareness of the value of prisoner interrogation in both higher and lower echelons and of the need for prisoner labor. As Red Army discipline improved, fewer prisoners were killed, and they were, by Soviet standards, treated with more consideration. Prisoners were interrogated more skillfully and in detail. No distinctions were made, as yet, between military and political prisoners, and all were put to work. There was still a comparatively small number of German prisoners, and only a small fraction of these survived the "punishment years" of the fourth phase.

Phase III began with the victory at Stalingrad. When Field Marshal Paulus' Sixth Army surrendered on 2 February 1943, the Russians claimed the capture of 23 German generals, 2,500 other officers, and 90,000 enlisted men who had survived the battle. During the great winter offensive which lasted from November 1942 through March 1943 (including Stalingrad), the Soviets claimed that they killed 850,000 German and satellite troops and took 350,000 prisoners.⁵ Manpower needs had continued to grow, and now that large numbers of prisoners were available a fairly

SECRET

SECRET

-210-

SECRET

SECRET

well-regulated organization was developed to exploit them. Prisoner rations and living conditions were slightly improved and a few recuperation and convalescent camps were set up. In the labor camps, however, prisoners were often literally "worked to death". Late in 1943, the Soviets began to make distinctions between political and purely military prisoners, the former (members of the SS units, secret field police, and the like) receiving much more severe treatment than the latter. A well-organized interrogation program began to function both in the field and in the camp. This program was designed to exploit every bit of useful information in the possession of the prisoners. High-ranking officers, technicians, and other of the better informed prisoners were sent for extended periods to special camps where highly trained, expert interrogators subjected them to exhaustive interrogations on all possible subjects. During this period the Soviets also began an extensive program of propagandizing prisoners (the antifa movement) and of exploiting them for political purposes. Selected prisoners who expressed or simulated enthusiasm for communism were sent to schools where they were trained to become propagandists or informers in prisoner-of-war camps and the nucleus of a communist movement and an espionage system in postwar Germany. The Soviets carefully staged the formation of the "National Committee for Free Germany" (NKFD)

SECRET

SECRET

-211-

SECRET

SECRET

to give it the appearance of a spontaneous movement on the part of the Germans. Many high-ranking German prisoners lent their names to this organization (often against their wishes or without their knowledge) which, in the long-run, failed to receive the support of the great majority of the prisoners.

Phase IV, which began at the end of the war, ushered in a period of intense suffering on the part of the prisoners. The German Armed Forces High Command (OKW) estimated that approximately four million German prisoners were in Russian hands at the end of the war and that about half of these died from hunger, over-work, disease, and brutal treatment.⁶ The Russians seemed to adopt the attitude that prisoners were to suffer punishment for the collective guilt of the German people: the already inadequate food rations were cut still more; prisoners were forced to perform the hardest types of labor and to meet production quotas that would have exhausted well-fed, healthy men.

Interrogations continued to take place, the emphasis now being placed on information about the western powers (United States and Great Britain). Attempts were also made to discover "war criminals," various categories of intellectuals, German military intelligence personnel, and "fascists" among the prisoners.

SECRET

SECRET

-212-

SECRET

SECRET

As the lot of the general run of prisoners became worse, that of the collaborators became better. Hunger, inhuman living conditions, and hope of repatriation drove a few prisoners into the ranks of these collaborators. The program of propagandizing prisoners, while not completely abandoned, was not emphasized during this period. Toward the end of 1946, conditions began to improve, and a few prisoners were even permitted to send a limited number of letters to their homes.

Phase V began in the fall of 1947 following the submission of repatriation plans by the Allied Powers in accordance with the agreement of the Council of Foreign Ministers providing for the repatriation of all prisoners in Allied hands before 31 December 1948. From this point on, prisoners were given better food, clothing, and housing; more (though far from all) of the prisoners were allowed to write letters, and the propaganda program hit a new peak of intensity.

During Phase V, the interrogation program also underwent a change. It was accelerated and the emphasis was almost entirely on an attempt to discover war criminals or prisoners who were guilty of one or more of a wide variety of crimes. Interrogations were conducted which resulted, invariably, in the finding of evidence against prisoners whom the Soviets did not wish to

SECRET

SECRET

-213-

SECRET

~~SECRET~~

repatriate. This evidence was used to try, convict, and sentence selected prisoners to long terms of hard labor in concentration camps for war criminals. These prisoners thereby lost their status as prisoners of war, and the Soviets could thus give a semblance of legality and truth to their subsequent claims that all "prisoners of war" had been repatriated. Actually, hundreds of thousands of German and Japanese prisoners were kept behind on trumped-up charges while the Soviets accomplished their double objective of maintaining a large supply of slave labor and retaining under their control a block of individuals capable of effective anti-Soviet leadership if repatriated.⁷

Methods of interrogation as practiced by the Soviets during and after World War II differed considerably in each of the five phases outlined in the preceding discussion. The principal change occurred at the beginning of Phase III when the NKVD apparently took over most of the strategic interrogation program from the military. After the war, of course, the emphasis changed from immediately useful tactical and strategic information to long-range strategic information concerning potential enemies of the Soviet Union and to the "confessional" types of information needed to implement the Soviet political and forced-labor programs.

SECRET

SECRET

SECRET

SECRET

B. Soviet Interrogation Methods as Applied in the Field

1. Some Aspects of Soviet Intelligence Doctrine

Interrogation of prisoners of war by the Soviets has had a broader purpose than that of most nations. Soviet interrogations have been intended not only to provide tactical and strategic information for military commanders but also to solicit agents and subversives for use within the lines of the enemy and for implementing the higher political aims of the Soviet Union and the Communist party.

While Soviet military intelligence doctrine has placed much emphasis upon the importance of prisoner interrogation, more emphasis has been placed upon the value of ground observation and reconnaissance and upon elaborate systems of agents placed within the enemy lines for purposes of securing tactical information about the enemy situation.⁸ Although the latter methods of gathering intelligence will not be discussed in detail, it is necessary, however, to mention that the Russians did make most effective use of reconnaissance and of agents and that they had highly developed techniques in these fields of intelligence.

As has been noted, the Red Army was required to evacuate prisoners to the rear with what, to foreign observers, seemed to be excessive haste, and combat echelon military interrogators were permitted to question prisoners only briefly on matters of

SECRET

SECRET

SECRET

SECRET

immediate tactical interest to the lower unit commanders. Despite this seemingly secondary role to which interrogation was relegated in practice, Red Army field commanders continued to ascribe much importance to this method of gathering combat intelligence.⁹

In the strategic interrogation program, prisoners were of primary importance to the Soviet high command. German staff officers, since the war, have admitted that by the end of 1943 the Soviets had "an absolutely precise picture of Germany's military and industrial potential," and that their information about Germany's order of battle and tables of organization "was almost complete down to the last German battalion, with even the names and characteristics of commanders fairly accurately recorded."¹⁰

2. Russian Characteristics Affecting Interrogation Methods

The Russians as a people are possessed of a number of psychological characteristics which have set them apart from other Europeans and Asiatics. These characteristics have undergone minor modifications under the Soviet regime and have been the subject of many volumes written by non-Russians. Any discussion of psychological characteristics applicable to Russians as a whole leaves considerable margin for error because of the heterogeneous character of the population. The following comments cannot even be considered a comprehensive discussion of the subject as it affects interrogation, but they may point the way to a better

SECRET

SECRET

-216-

SECRET

SECRET

understanding of some aspects of Soviet treatment of prisoners of war.

The Russian, as an individual, is given to wide variations of mood, fluctuating erratically from exuberant good-nature and cordiality to gloomy depression and cruelty. The Russian masses are susceptible to political and religious psychoses.¹¹ The same interrogator may be cruel on one occasion and kind on the next. But much that appears to be incredibly cruel to western people is not considered cruel by the Russians. Lower standards of living in Russia are partially responsible for this characteristic. Physical and mental suffering is endured stoically and viewed with equanimity.

Soviet citizens, particularly officials, usually adopt a superior attitude toward nationals of other countries. Psychologically, this conceit may be in part a compensatory reaction caused by a national inferiority complex (as claimed by some psychologists), but it is also partially compounded of genuine egotism engendered by Soviet propaganda and based on ignorance. This egotism can be a handicap to an interrogator whose judgment is thereby adversely affected when making evaluations of persons or information.

The Soviet regime has kept itself in power by maintaining close secret surveillance over every citizen. Consequently, an

SECRET

SECRET

-217-

SECRET

SECRET

air of suspicion and distrust pervades the Soviet Union. No one trusts anyone else, a characteristic handed down from Tsarist days. A Russian's treatment of prisoners when he is alone with them is often quite different than when other Russians are present.

Super-bureaucratic regulations attempt to prevent failure or shortcomings on the part of individual Soviet citizens. Failure is often regarded as treason or sabotage and may be punished by death. Hence, interrogators will go to any length to get desired information, and prisoners, under duress, often make statements or sign confessions on matters about which they have little or no knowledge in order to satisfy an interrogator who is determined not to fail at any cost.

Russians have been taught that all members of non-Communist nations are their sworn enemies: hence, every prisoner, because he is an enemy of the Soviet regime, is considered a liar as a matter of principle. Interrogations drag on, sometimes for years, merely in an attempt to prove that the prisoner is a liar.

Systematically created ignorance and misunderstandings about the non-Russian world plus chauvinistic propaganda which has glorified the Soviet way of life and exaggerated Russian accomplishments have proved to be handicaps to Soviet interrogators. Thus, many prisoners are thought to be liars when they tell the truth about conditions in their native countries because the truth is

SECRET

SECRET

-218-

SECRET

SECRET

contrary to Soviet teachings. Since a Soviet interrogator knows of no other way of life, he cannot, for instance, believe that a prisoner who once traveled as a tourist in the USSR was not really there on an espionage mission for his government. Such mental handicaps result in wrong evaluations, and prisoners who are believed to be lying suffer further hardships.

The obsession for political interpretations of actions and events which is a characteristic of Communists (and of most Soviet functionaries) makes itself evident even in questions asked by combat echelon interrogators and in the evaluation of the information. This obsession may be considered another handicap for Soviet intelligence personnel who sometimes draw irrelevant and faulty conclusions when attempting to interpret facts in keeping with current Soviet political theory.

Observers of the Red Army during World War II have frequently commented on the influence of alcohol on the behavior pattern of the average Russian. Whether the tendency to drink to excess is based on psychological factors or whether the excessive consumption of alcohol produces effects similar to psychotic disturbances cannot be determined here, but there is no doubt that some of the brutal excesses committed by Russians against the Germans were committed by Red Army personnel under the influence of alcohol. Prisoners of the Russians were often mistreated or shot by drunken

SECRET

SECRET

-219-

SECRET

SECRET

13

guards, interrogators, or other individuals.

The foregoing comments on psychological characteristics of Russians, as modified by the Soviet regime, have emphasized mental and psychological handicaps under which Soviet intelligence personnel have performed their tasks. It must be kept in mind, however, that most top-level Soviet leaders have been hard-headed, intelligent realists who have not suffered the delusions which they have deliberately created in the minds of the masses. Evaluation of prisoner information in the highest echelons of the Soviet intelligence service has apparently resulted in realistic and accurate conclusions concerning enemy potentialities and intentions.

3. Interrogation in Combat Echelons of the Red Army During the First Stage of the War

Generalizations about Soviet interrogation methods are difficult to make since methods seemed to differ, superficially at least, with each interrogator. Appendix VI of this study consists of forty short excerpts from documents, each of which pertains to methods or procedures used by Soviet interrogators. Part One (Items 1 to 25) of this appendix consists of case histories or statements about interrogations of prisoners of war. Part Two consists of examples of political interrogations. It is recommended that, if possible, the reader study Appendix VI before, or

SECRET

SECRET

-220-

SECRET

SECRET

immediately after, reading this and the following sections of this study which pertain to actual methods practiced by Soviet interrogators in the field and in the prisoner-of-war camps.

NKVD interrogations in the prisoner camps assumed fairly definite patterns of procedure: that is, a prisoner who was thought to be withholding information or who refused to co-operate in signing statements or confessions was subjected to a systematic program of terror which was effective in breaking his will to resist the demands of his interrogators.

Interrogation in the combat echelons of the Red Army also assumed a definite pattern, especially after Stalingrad, but this pattern has not emerged as clearly as that of the camp interrogation procedure. Since the principal source of information for this part of the study has been former German prisoners of the Soviets and since practically none of these prisoners were captured prior to Stalingrad, little information on actual practices in the field during the first two years of the war is available. Interrogations in the field were usually brief, and prisoners were evacuated rapidly to the rear during a time when most of them were still suffering from the shock of capture and all was strange and confused. The prisoners were questioned by many interrogators in different uniforms and few of them could distinguish between military intelligence, NKVD,

SECRET

SECRET

-221-

SECRET

SECRET

and Political Directorate personnel; neither could they be sure whether it was a battalion, a division, or a corps headquarters at which they were being questioned. The whole procedure was finished within a few hours or days, and their memories of this phase of their prisonership are usually hazy and confused. In the camps, however, the prisoners had time to get their bearings, and their memories of camp interrogations are vivid and bitter. Nearly all repatriated German prisoners have been reluctant to discuss their experiences, either because of fear of eventual reprisals or because they seem to prefer to forget this period in their lives. Former German staff officers who collaborated on the series of studies (PW Project #14) upon which much of this part of this study is based have remarked at length on the difficulties experienced in collecting information on Soviet methods of interrogation from repatriates.¹⁴

During the first phase of the war few prisoners were taken and even fewer survived capture. This practice of killing prisoners persisted even into 1943 despite strict orders to the contrary.¹⁵ The Red Army conducted practically all interrogations during the first phase of the war, although the political commissars and the 00 NKVD units participated in the interrogation program to a limited degree.

Disregarding the normal procedure, under which most prisoners

SECRET

SECRET

-222-

SECRET

SECRET

were not interrogated at all or only briefly before being killed, the interrogation and evacuation procedure seems to have followed that prescribed in the 1940 instructions which have already been discussed at some length earlier in this study.

Immediately after capture the prisoner was disarmed and searched for papers, documents, and maps. Members of the capturing party nearly always robbed the prisoner of all of his personal possessions, sometimes stripping him almost naked; boots, gloves, and underwear were frequently taken by the underclothed Russians and not replaced, even in winter weather. If the capturing soldiers did not steal the prisoner's personal possessions, interrogators and officers did later. This practice seemed to continue throughout the war despite regulations and specific orders to the contrary.¹⁶ These orders specified that property which could be used to facilitate escape could be confiscated, and this point was broadly interpreted; watches, eyeglasses, even wedding rings disappeared into the pockets of Russians who had been denied such luxuries all their lives. On the other hand, discipline was apparently good on the matter of sending papers, documents, maps, and new or unusual equipment back through channels to intelligence sections where evaluations could be made.

Except for a few questions about the immediate situation which were sometimes asked by company officers of the capturing unit, the

SECRET

SECRET

-223-

SECRET

SECRET

first interrogation usually took place at battalion headquarters. Sometimes this first interrogation took place at regiment, according to the standing operating procedure of the individual unit or the availability of interrogator and interpreter personnel. Officers, noncommissioned officers, and enlisted men had by this time been separated into groups and were not allowed to mingle.

Prisoners were interrogated individually, and answers were written down on a simple personnel form. Questions were confined to personal data and to the immediate combat situation. Typical examples of these personnel forms may be seen in Appendix I, Forms 1, 2, and 3. This form, and subsequent forms filled out at higher echelons, accompanied the prisoner on his way to the rear and formed the beginning of a complete dossier which was kept on each prisoner throughout his imprisonment. Forms were probably made in duplicate or triplicate, one of which was retained by the interrogating unit, the others being forwarded with the prisoner. These forms sometimes included a consignment and receipt form to place responsibility for delivery of prisoners on the next higher echelon and to relieve the guard detail which had escorted them to the rear from further responsibility. (See Appendix I, Form 1.)

Especially important information gained by prisoner interrogation at any echelon was forwarded by the fastest possible means

SECRET

SECRET

-224-

SECRET

SECRET

to higher echelons and appropriate lower or neighboring units. Especially knowledgeable, high-ranking, or otherwise important prisoners were dispatched by vehicle if possible to the next higher echelon.

Interrogations were usually conducted by an officer (the battalion executive officer or the PNSch 2 of the regiment) with the aid of an interpreter. Sometimes the unit commander participated in an interrogation, and at other times three or four officers would be present including political commissars and NKVD personnel. All statements were written down, sometimes during the interview, sometimes afterward. Soviet instructions on this matter were that as a general practice notes were to be taken after the interview.

Interrogation methods were often brutal, particularly if the prisoner refused to talk or to sign prepared statements. The questions were direct and little if any subtlety was attempted. The interrogator usually took the attitude that the prisoner was lying, and the latter was subjected to shouted abuse, table pounding, threats of death, beatings, and torture. Interrogators sometimes played with a pistol throughout the interview, threatening the prisoner with it from time to time. During the first two stages of the war, prisoners were often shot after the initial interrogation, even after they had talked freely. On the other hand,

SECRET

SECRET

-225-

SECRET

SECRET

there are recorded instances of prisoners who were treated with soldierly correctness, who were interrogated courteously, and who were given cigarettes, liquor, and food. More often, prisoners were fed, clothed, and sheltered inadequately during the evacuation process, factors which combined with excessively long daily marches to the rear (during which stragglers or the exhausted were shot) resulted in a high rate of mortality before the prisoners¹⁷ reached camps in the interior.

Incompetent interrogators often took the attitude that even the lowliest private should know the answers to every question and they consequently threatened or tortured the prisoner in an effort to make him talk. Thus intimidated, many prisoners fabricated answers in an attempt to placate the interrogator. These answers later sealed his doom because they proved him to be a liar.

In some instances prisoners or deserters were recruited after or during their initial interrogation to return to their own lines as agents or subversives. Others were forced to write letters or to sign statements which could be used in the psychological warfare program (to inspire desertions or disaffection in the German ranks).¹⁸ Prisoners who were known to have relatives in a zone occupied by the Russians were often recruited as stool pigeons or agents with the threat that reprisals would be taken against their relatives if they did not faithfully undertake

SECRET

SECRET

-226-

SECRET

SECRET

assigned missions.

From the beginning, stool pigeons were used to spy on the prisoners, to gain their confidence and thus to discover whether the prisoner had lied during his interrogation. These stool pigeons entered the ranks of the prisoners, were processed and treated the same as other prisoners, and were evacuated with the others to prison camps. Some were easy to detect, others were very clever and passed as bona fide prisoners. Intelligence personnel posing as medics were trained to gain the confidence of wounded prisoners, to pretend to befriend them, and to remember important bits of information which were overheard or gained in friendly conversations.

The Soviet high command, throughout the war, emphasized time and again the importance of rapid evacuation of prisoners to the rear. Prisoners were supposed to remain at battalion and regimental headquarters for no more than thirty minutes (or not more than three hours according to some sources), and if there were large numbers of prisoners interrogation was to consist of no more than the gathering of the personal data on each prisoner and spot questioning of the more important captives. During the first two years of the war, the guard-escort who conducted prisoners back to division frequently murdered them during this phase of the evacuation process (probably using the time-worn excuse that the

SECRET

SECRET

-227-

SECRET

SECRET

prisoners had tried to escape), and rear area Russian soldiers took this opportunity to kill a few Germans as the convoy passed their positions.

At division, sometimes at corps, the second interrogation took place. This was far more thorough than the first and may be designated as the main interrogation. All prisoners were questioned according to a form which was much more elaborate than that used at battalion or regimental level. (See Appendix I, Forms 4 and 5.) This form contained many questions which the average German soldier was unable to answer. Differences between interrogator and prisoner began to develop at this level as statements made here differed from those recorded on the earlier form. The prisoner suffered when the interrogator found contradictions and, on that basis, accused the prisoner of lying or withholding information. The same direct, brutal-if-necessary techniques of interrogation were used here as at lower levels early in the war. Military questions were confined to the immediate combat situation, but many questions were about conditions in Germany, and there was evidence of great curiosity on the part of the Russians concerning civilian ways of life in other countries. (Questions on the latter subject were asked by all interrogators from the lowest to the high-echelons, sometimes outweighing questions on military matters. Officially, such questions were supposed to be asked only by political

SECRET

SECRET

-228-

SECRET

SECRET

commissars or NKVD personnel rather than by military interrogators.)

Many of the prisoners endured their last interrogations at the hands of military intelligence personnel at division level. German officers were, of course, carefully interrogated at all levels. Duplicates of the interrogation forms were sent to higher echelons where routine examination of the forms occasionally indicated some reason for additional interrogations. Otherwise, the myriad bits of information supplied by the ordinary prisoners were recorded in the elaborate files maintained in higher echelon intelligence units and became the basis for order of battle reports and long-range estimates of the situation. / At division (or corps), however, the better informed prisoners and the technical specialists were earmarked for interrogations at higher echelons by intelligence personnel from the intelligence sections (RO's) of appropriate arms and services.

German military intelligence personnel, suspected agents, deserters, and political personnel (members of militant political organizations such as the SS, SD, etc.) were kept apart and interrogated by personnel of the OO NKVD units, after which they were either "liquidated" or sent to higher echelons of the OO NKVD for further questioning. The Red Army lost jurisdiction over such prisoners at division level.

SECRET

SECRET

-229-

SECRET

SECRET

The political commissars also questioned prisoners at this level. Their questions were principally on matters concerning political ideologies and the morale of enemy troops; they were also interested in the effect of Soviet propaganda leaflets and broadcasts on German soldiers and were on the lookout for information to include in future propaganda leaflets.

Apparently, many interrogations were carried out in the presence of the unit commander, the military intelligence officer, a political commissar, the NKVD interrogator, and an interpreter, all of whom bombarded the confused prisoner with questions. In most cases, no semblance of order was achieved in the processing and interrogation of prisoners until mid-1943, although effective use was being made of prisoner information long before that.

While interrogations at division or corps level were supposed to be thorough, the high command nevertheless insisted upon rapid evacuation of prisoners to army level for the third interrogation. The corps was normally bypassed in the evacuation process and if interrogations were carried on at this level, they more or less duplicated the procedure normally carried out at division.

Few prisoners were captured early in the war; therefore, most of them were subjected to this third interrogation at army level which was somewhat broader in scope than at division or corps level (home address, tour of duty, and similar details), but most questions

SECRET

SECRET

SECRET

SECRET

still pertained to the military situation and lower unit tactics. If there were large numbers of prisoners, only the more important or best informed were questioned, along with those whose interrogation forms received from lower echelons indicated a need for further questioning. A few important prisoners were sent to front (army group) headquarters and even to the GRU in Moscow for further interrogations, and technical specialists among the prisoners were questioned at length by personnel of the RO's of the various arms and services. Otherwise, it may be assumed that the army intelligence section concerned itself primarily with the systematic evaluation of information contained in the numerous prisoner-interrogation forms received from lower echelons. Consolidated reports were sent twice daily to the army group RU while appropriate findings were disseminated to various headquarters of the command and to adjacent units.

At army level, the prisoner usually met, for the first time, Soviet intelligence personnel who were trained interrogators and who were to some extent familiar with conditions in Germany and with German military organization and tactics. Brutal methods, as a rule, were frowned upon, and the prisoners were treated with a certain amount of traditional military courtesy.

From army level, practically all prisoners were evacuated to the zone of interior where they were assigned to various prisoner-

SECRET

SECRET

SECRET

SECRET

of-war camps. According to German reports, these camps were under the jurisdiction of the Red Army during the first stage of the war. If this was actually the practice, it was not strictly in accordance with the 1940 instructions which specified that the NKVD was to take over the prisoners at army level. In any event, prisoners in the camps were subjected to few if any systematic interrogations before the second stage of the war (spring of 1942).

The foregoing discussion of interrogation methods and procedures practiced during the first stage of the war may have given the impression of orderly plan and execution. This, emphatically, was not the situation. The retreating and temporarily defeated Red Army was in no condition, nor had it the proper preparation and training, to carry out orderly procedures in matters pertaining to prisoner interrogation. Prisoners were sometimes questioned only at division and then shipped to concentration areas, or sent from division directly to front headquarters and then to the interior. (See Appendix VI, Items 1, 5, and 7.) Despite changes in organization and procedure initiated by the Soviet high command in the spring of 1942, it was not until the third stage of the war that an orderly and uniform system for the interrogation and evacuation of prisoners began to function smoothly and efficiently.

SECRET

SECRET

-232-

SECRET

SECRET

4. Interrogation in Combat Echelons of the Red Army During the Second and Third Stages of the War

a. Military Interrogation in the Field

During the winter of 1941-42, the Red Army had been able to stabilize its lines and even to undertake some offensive operations. By the spring of 1942, the Red Army had undergone considerable reorganization. Incompetent leadership had been replaced by experienced, battle-proven personnel, and lessons learned during the first disastrous months were resulting in the adoption of new methods and in the improvement of the training program.

With regard to prisoners of war, two factors had been at work with far reaching effects on the interrogation program, beginning with the second stage of the war: (1) manpower needs for Russia's industry and agriculture were acute, and Soviet leaders were eager to utilize large numbers of prisoners as laborers; (2) an increasing awareness of the value of prisoner interrogation had been accompanied by growing dissatisfaction with interrogation results.

The changes which took place in regard to prisoner treatment and interrogation consisted more of enforcement of hitherto disregarded regulations than of the adoption of newly conceived procedures. According to Red Army regulations in existence at the beginning of the war, enemy soldiers who surrendered were to be

SECRET

SECRET

-233-

SECRET

SECRET

granted quarter. In practice, the Soviet high command apparently tolerated the killing of prisoners during the first stage of the war. Beginning in the winter of 1941-42, however, the high command began to send out an increasing number of orders to the effect that prisoners' lives were to be spared and that they were not to be robbed of their personal possessions. The Red Army was slow, apparently, to respond to this new dispensation, and numerous instances are recorded of the massacre of German prisoners even after Stalingrad, which was a turning point in the treatment of prisoners. An order which fell into German hands, dated December 1942 and issued by a Soviet cavalry corps, quoted higher authority in decreeing that Germans who surrendered were to be treated well.¹⁹ On the other hand, many Russian prisoners claimed that after the Germans had refused to surrender at Stalingrad, an order had been issued which specified that no more prisoners were to be taken. According to the same Russian prisoners, this order was cancelled before the surrender of Paulus' Sixth Army.²⁰ According to some reports, this order was rescinded a few days before the termination of the fighting at Stalingrad. The rescinding order may have been Stalin Order No. 171.²¹

A Soviet officer captured by the Germans in March 1943 professed that during his tour of duty as a corps intelligence officer he had seen several orders from the corps commanding general

SECRET

SECRET

-234-

SECRET

SECRET

directing the troops not to shoot prisoners but to forward them to corps headquarters for interrogation.²² Various other orders issued by Red Army commanding officers were captured by the Germans, which ordered the troops not to kill prisoners or to take their clothing and personal possessions.²³

The Soviet high command obviously had difficulties in gaining compliance with its orders regarding the treatment of prisoners. The important fact is, however, that the orders did take effect, although slowly, and more and more prisoners survived capture, thereby becoming available for interrogation. Toward the end of the war, practically all prisoners were spared, and their treatment in the evacuation process improved. The reasons for this were primarily economic rather than humanitarian: prisoners who arrived at a labor camp sick, exhausted, frost-bitten, or starved were not much use as laborers. The high command was never able to stop completely the practice of stealing prisoners' personal possessions immediately after capture, but (except for the taking of winter clothing which caused the death of many prisoners) this was regarded as a comparatively minor matter and was tolerated. Rapid evacuation of prisoners, however, was considered important by the high command and was the subject of reprimands and orders to lower units throughout the war.

SECRET

SECRET

-235-

SECRET

SECRET

It will have been noted that the OO NKVD units, which became UKR NKO (Smersh) units in 1943, conducted part of the interrogation program in the field. Members of these organizations were all Communists and were under direct supervision of the NKVD or the NKGB, the latter an offspring of the former and both direct agencies of the Communist party.²⁴

Another agency having an important part in the interrogation program was the Main Political Directorate of the NKO which had Political Sections attached to field headquarters of the Red Army in all echelons of command down to and including divisions. Though nominally a part of the Red Army, the Main Political Directorate and its political commissars took their directions from the Communist party. Neither the political commissars nor personnel of the counterintelligence units (OO NKVD) communicated results of their interrogations to military intelligence sections, except for important bits of combat intelligence which were gained incidentally in their investigations.

There were several reasons for this shift of responsibility for interrogation from the Red Army to the NKVD and other agencies directly related to the Communist party: (1) the Soviet high command was dissatisfied with the Red Army's handling of the interrogation program during the first stage of the war; (2) the NKVD was the traditional agency responsible for espionage

SECRET

SECRET

-236-

SECRET

SECRET

directing the troops not to shoot prisoners but to forward them to corps headquarters for interrogation.²² Various other orders issued by Red Army commanding officers were captured by the Germans, which ordered the troops not to kill prisoners or to take their clothing and personal possessions.²³

The Soviet high command obviously had difficulties in gaining compliance with its orders regarding the treatment of prisoners. The important fact is, however, that the orders did take effect, although slowly, and more and more prisoners survived capture, thereby becoming available for interrogation. Toward the end of the war, practically all prisoners were spared, and their treatment in the evacuation process improved. The reasons for this were primarily economic rather than humanitarian: prisoners who arrived at a labor camp sick, exhausted, frost-bitten, or starved were not much use as laborers. The high command was never able to stop completely the practice of stealing prisoners' personal possessions immediately after capture, but (except for the taking of winter clothing which caused the death of many prisoners) this was regarded as a comparatively minor matter and was tolerated. Rapid evacuation of prisoners, however, was considered important by the high command and was the subject of reprimands and orders to lower units throughout the war.

SECRET

SECRET

-235-

SECRET

SECRET

It will have been noted that the OO NKVD units, which became UKR NKO (Smersh) units in 1943, conducted part of the interrogation program in the field. Members of these organizations were all Communists and were under direct supervision of the NKVD or the NKGB, the latter an offspring of the former and both direct agencies of the Communist party.

Another agency having an important part in the interrogation program was the Main Political Directorate of the NKO which had Political Sections attached to field headquarters of the Red Army in all echelons of command down to and including divisions. Though nominally a part of the Red Army, the Main Political Directorate and its political commissars took their directions from the Communist party. Neither the political commissars nor personnel of the counterintelligence units (OO NKVD) communicated results of their interrogations to military intelligence sections, except for important bits of combat intelligence which were gained incidentally in their investigations.

There were several reasons for this shift of responsibility for interrogation from the Red Army to the NKVD and other agencies directly related to the Communist party: (1) the Soviet high command was dissatisfied with the Red Army's handling of the interrogation program during the first stage of the war; (2) the NKVD was the traditional agency responsible for espionage

SECRET

SECRET

-236-

SECRET

SECRET

and counterintelligence and had available a comparatively large number of trained intelligence personnel along with school facilities for the rapid training of new interrogators, interpreters, and evaluators of prisoner information; (3) the Soviet regime has, as one of its fundamental principles of holding power, always maintained strict censorship over information going in and out of Russia. The strategic intelligence program involved the collection of true facts about conditions in other countries, and Soviet leaders were determined to confine this information to the smallest possible number of trusted individuals within the Communist party. Members of the NKVD who conducted the strategic interrogation program were carefully screened for their loyalty and trustworthiness.

While the Red Army suffered some disadvantages from the centralization of the interrogation program in the hands of the NKVD, actually it was a progressive step so far as the nationwide war effort was concerned. The military was still permitted to gather the vitally important combat intelligence which is so necessary to the day-to-day conduct of operations in the field. Even combat information of this nature, when collected systematically from huge numbers of prisoners, can be collated and evaluated, resulting in strategic intelligence on matters such as order of battle and the status of reserves. It may be assumed

SECRET

SECRET

-237-

SECRET

SECRET

that the GRU in Moscow carried on such activities but that very little such activity had been carried on early in the war.

The main emphasis in the interrogation program was shifted during the second stage of the war from the field to the camps. The NKVD performed the enormous task of subjecting all prisoners to long interrogations in the prisoner-of-war camps. In addition to the information collected in this manner, the NKVD had available each prisoner's dossier containing copies of all previous interrogation reports made on the prisoner, signal intelligence monitoring service reports, agents reports, and other files of information normally collected by top-level strategic intelligence services of great military powers. Strategic intelligence formulated by the NKVD was transmitted immediately to appropriate high-ranking political leaders who were directing the war effort; many of these political leaders were military leaders as well. Red Army leaders not included in the Kremlin's inner circle were given only such strategic information as was considered necessary for their proper conduct of operations in the field.

By the third stage of the war, sufficient numbers of trained and experienced interrogation personnel were available to staff almost all headquarters of the Red Army. Interrogations were carried out in a uniform manner, resulting in more complete coverage on the combat situation and permitting faster and more accurate

SECRET

SECRET

-238-

SECRET

SECRET

evaluations in higher headquarters. As another result of experience and of better training and organization was the more expeditiously channeling of information to higher headquarters and its dissemination to interested headquarters and agencies.

So far as military intelligence interrogations and prisoner evacuation from the point of capture to army level were concerned, procedures differed little from those described as taking place during the first stage of the war, except that during the second and third stages, prescribed procedures became the rule rather than the exception. Brutal techniques disappeared almost entirely during interrogations, though not during evacuation, and prisoners were treated with a reasonable amount of soldierly courtesy by interrogators. Officers nearly always conducted the interrogations, and their techniques improved rapidly during the second stage of the war. The quality of interpreter personnel, however, did not seem to improve as rapidly as that of the interrogators.

One of the few documents available on the matter of Soviet instruction in the technique of interrogation is a German interrogation report which has been reproduced as Appendix IV of this study. This document describes a lecture on interrogation and a demonstration of a model interrogation which had been a part

*See page 187 of this study for the background information on this document.

SECRET

SECRET

-239-

SECRET SECRET

of a three-day course of instruction presented to intelligence officers in the field. Undoubtedly, much more time was devoted to the technique of interrogation in basic and advanced courses for intelligence personnel, but this demonstration and lecture may be assumed to be a condensed version of what was taught in the longer courses. This isolated report cannot, of course, be accepted as the final word on interrogation procedure recommended by Red Army intelligence authorities; on the basis of accounts given by former German prisoners, however, it may be evaluated as being "probably true." Understandably, the Soviet prisoner told of no brutal practices and emphasized that prisoners were treated humanely. It may be appropriate to note that few Red Army regulations or written orders which are available recommended or prescribed procedures which would violate generally accepted rules of land warfare.

Significant aspects of Soviet interrogation techniques revealed by the afore-mentioned source were:

1. Emphasis on proper preparation by the interrogator before the interrogation (familiarity with the situation, knowledge of information which is needed);
2. Careful checking of a prisoner's veracity by cross-examining him on previously made statements;
3. The psychological approach of pretending that the true answers to the questions asked were already known;

SECRET SECRET

SECRET SECRET

4. The selection of an interrogator, if possible, whose personality inspires a favorable response from the individual prisoner;
5. A preference for the kindly or polite approach as being psychologically more effective (food, brandy, and cigarettes for the prisoner before questioning);
6. The use of stool pigeons and intelligence personnel posing as medics who gained information from prisoners by subterfuge;
7. The presence in the front lines of intelligence officers from regiment or division to question prisoners immediately after capture;
8. Emphasis on gaining the following information by military intelligence officers from regimental to army headquarters:
 - a. Training of the prisoner
 - b. Strength and fighting power of his unit
 - c. Reserves
 - d. Artillery
 - e. Tanks
 - f. Engineer equipment
 - g. Chemical warfare equipment
 - h. Sanitary and veterinary facilities
 - i. Troop morale 25
 - j. Mission of the prisoner's unit.

During the second and third stage of the war, the prisoner-evacuation procedure, with brief pauses for questioning at the various headquarters, remained much the same as that prescribed (but seldom practiced) during the first stage of the war. Officers, noncommissioned officers, and onlisted men were kept in separate groups throughout the evacuation process as were members of the SS, the Gestapo, the secret field police, intelligence personnel,

SECRET SECRET

SECRET SECRET

deserters, suspected enemy agents, and other prisoners who were to be turned over to the Smerish unit at division.

The various steps of the combat interrogation process during the latter stages of the war correspond so closely to those described for the first stage that they will be dealt with as briefly as possible in the following paragraphs, but some duplication is unavoidable.

The first formal interrogation took place at battalion, sometimes at regiment with all prisoners being questioned by military intelligence interrogators at this level. This was a brief interrogation in which a uniform questionnaire was filled out and a copy forwarded to division with the prisoner. (The forms used probably corresponded to those used during the first stage. See Appendix I, Forms 1, 2, and 3, or Appendix III, Item 3.)

At division, sometimes at corps, the second or main interrogation took place. This was also conducted according to a uniform questionnaire by trained male or female interpreters. (Typical questionnaires used at this level may be seen in Appendix I, Forms 4 and 5, and Appendix VII.) A division or corps intelligence officer was normally present to ask questions of immediate interest not covered by the questionnaire. At division level were begun extensive interrogations of selected prisoners by the Political Directorate Section and the Smerish unit of that headquarters.

SECRET SECRET

SECRET SECRET

These interrogations will be discussed separately. Prisoners were kept at division or corps only long enough to complete the questionnaire forms and then were sent to army.

During the latter stages of the war, general interrogations no longer took place at army level. Whenever it appeared necessary, however, selected prisoners were re-interrogated by army intelligence officers, and important prisoners were subjected to a thorough questioning. Prisoners possessed of specialized or technical knowledge were questioned by the RO's of appropriate arms and services.

The army's intelligence section co-operated with an NKVD evaluation section at this level in evaluating reports received from lower echelons. The principal functions of the army intelligence section were (1) to inform commanders immediately about the most recent data received on the enemy, and (2) to furnish higher headquarters with properly evaluated information gathered from all sources, including prisoners, within the army's zone of responsibility. On occasion, the army intelligence section selected prisoners who seemed suitable for missions of espionage, incursion, and sabotage, briefed and trained them for specific assignments, and sent them back across the front lines. This latter activity, however, was more a prerogative of the NKVD than of the army RO.

SECRET SECRET

SECRET SECRET

High-ranking, especially well-informed, and other important prisoners were always to be sent from the front lines to higher headquarters by the fastest means available. Such prisoners were usually afforded comfortable living conditions and dignified treatment, at least as long as they were under the jurisdiction, of the military. Important information secured from prisoners at any level was communicated to higher and other appropriate headquarters by the fastest signal means available.

b. Political Interrogations in the Field

As noted earlier in this study, at division level prisoners were subjected to an exhaustive interrogation by personnel from the Political Directorate Section attached to divisional headquarters. (A copy of a questionnaire used in this interrogation has been reproduced as Item 2 of Appendix III.) Under the most favorable circumstances and with a prisoner who was willing to talk, several hours must have been required to make each report. It must be assumed that the political section of a division headquarters was provided with a large number of hard-working interrogators and interpreters. (When large numbers of prisoners were taken, as at Stalingrad, it is logical to assume that such an interrogation did not take place until the prisoner reached a prisoner-of-war camp.) Since the directive regarding political interrogations appears in Appendix III, Item 1, only a few of the more significant

SECRET SECRET

-244-

SECRET SECRET

aspects of the political interrogation will be mentioned here.

First and foremost, it was the purpose of the Main Political Directorate to keep the prisoners under the influence of Soviet ideology. To accomplish this purpose, it was necessary (1) to discover and isolate incorrigible fascist elements, (2) to "convert" or re-educate neutral or "deluded" prisoners to the Soviet way of thinking and to arouse their class consciousness (or at least to alienate them from fascism), and (3) to thoroughly indoctrinate the prisoners who were already antifascist in order to form a hard core of communists among the prisoners. "Converted" soldiers were to be kept together, apart from the unconverted and incorrigible elements.

Since the Main Political Directorate was largely responsible for the psychological warfare program, the political commissars were particularly interested in the political and ideological training carried on in the German Army and in the effect of Soviet propaganda on German soldiers. Ideas and material gained through interrogation which could be used to improve the Soviet psychological warfare program were consolidated into special reports by the interrogators.

The directive gave broad, general directions on the manner in which interrogations should be carried out and emphasized the clarity and completeness which should characterize each report.

SECRET SECRET

-245-

SECRET SECRET

Apparently only one such interrogation took place during the evacuation process, and that interrogation normally took place at division level. A small number of re-interrogations probably took place at army level following an examination of the reports received from division. No brutal methods of interrogation were recommended in the directive. However, "confessions" were sometimes required by the political commissars, and it is possible that methods used in the camps by the NKVD to break the will of a prisoner were used here.²⁷ Normally, the emphasis was on speed of evacuation, and that would have left little time for such methods to be practiced in the field.

When complete in every detail, the divisional report was sent to the Political Section of the army headquarters, then to army group headquarters, and, finally, to the Main Political Directorate of the Peoples' Commissariat for Defense of Moscow. (Corps headquarters seems to have been bypassed in this particular phase of the interrogation program.) In other words, these reports were sent through channels separate from military intelligence channels, and military intelligence sections of the various field headquarters of the Red Army did not have access to this information. The GRU of the General Staff may have had access to a certain amount of this information after it had been processed by the Main Political Directorate.

SECRET

SECRET

-246-

SECRET SECRET

Significantly, a copy of the political interrogation report was sent with each prisoner to the prisoner-of-war camp where it became an important part of the dossier kept by the NKVD on each prisoner. Since the report contained exact and detailed data on each prisoner's educational background, occupation, and special skills, it undoubtedly played an important part in determining the prisoner's initial work assignment and the camp to which he was sent.

As has been noted, the Main Political Directorate with its system of political commissars, while nominally a part of the Red Army, was actually a direct agency of, and responsible to, the Communist party and co-operated to a certain extent with the NKVD.²⁸ Since both the political commissars who conducted interrogations in the field and the NKVD personnel who conducted interrogations in the camps were members of the Communist party and conducted similar types of investigations, most German prisoners assumed that all such interrogators were members of the NKVD. This may also account, in part, for the fact that since the war German writers on this subject have credited the NKVD with having taken over almost all of the interrogation program from the Red Army in 1943. Actually, the program was put into the hands of four agencies which had overlapping responsibilities, a typical example of Soviet bureaucratic procedure. Red Army intelligence

SECRET

SECRET

-247-

SECRET SECRET

had a small but important role in combat interrogation. The rest of the program was handled by agencies directly responsible to the Communist party: the Main Political Directorate, GUKR NKO (Smersh), and the NKVD. (The NKGB, as the supervising agency of GUKR NKO, was thus indirectly involved in the interrogation program.)

c. Smersh Interrogations in the Field

The GUKR NKO (originally the OO NKVD)²⁹ as a counter-intelligence agency was interested only in special categories of prisoners of war so far as interrogation was concerned.³⁰ This agency also conducted interrogations of numerous categories of Red Army personnel, particularly those claiming to have escaped German captivity, and of Soviet citizens in territory formerly occupied by the enemy, but these types of interrogation fall outside the scope of this study.

The categories of prisoners of war interrogated by Smersh units were: (1) enemy agents captured in the zone of operations or turned up by the surveillance net operated within the Red Army ranks by Smersh; (2) all prisoners of operational interest to Soviet counterintelligence, that is, members of the SS, the Gestapo, the secret field police, any personnel who had been assigned at any time to German Army intelligence and counterintelligence agencies, enemy partisans, and prominent enemy

SECRET SECRET

SECRET SECRET

political personages.

A short but valuable report which throws some light on day-to-day operations of Smersh units has been secured from a Hungarian national who was pressed into service as an interpreter for an army Smersh unit in 1945.³¹ The particular operations described here, of course, were performed by a higher echelon unit and took place late in the war after the Red Army had pushed across the border into hostile territory on the Ukrainian front. According to this source, personnel assigned to his Smersh unit wore a variety of uniforms, the only distinctive element of which was a red band which was sometimes worn on the cap. Some of the personnel habitually wore civilian clothes. They wore an elite group within the army, had separate messes, and were always able to procure sufficient transportation (lend-lease trucks or confiscated automobiles). Each member of the unit carried an official card bearing his name and the statement, "Military authorities are requested to cooperate with him." In effect, this card gave the bearer authority over all military personnel regardless of rank.

From an operational standpoint, the unit was divided into two groups, (1) the arresting group (probably from the operations section), which entered towns and made arrests, and (2) the interrogation group, a rear echelon unit. The first group consisted

SECRET SECRET

SECRET SECRET

of from 10 to 25 officers and enlisted men; personnel of this group changed often and were called into front line action from time to time. The interrogation group consisted of from 70 to 80 officers and enlisted men, and the personnel of this group seemed to be permanently assigned. A full colonel commanded the latter group.

Every morning the arresting group had a meeting in which assignments were made; then the group would break up into parties of two or three men each which would enter villages in the army zone of responsibility to make arrests. Usually Smersh had lists of Communists or friendly people who lived in each town and who were called upon first by the arresting party. From those people the arresting party would receive the names or identity of suspects who were thereafter arrested and taken back to the interrogation group. The local collaborators sometimes assisted in making the identification at the time of arrest and assisted as interpreters during the interrogation. Arresting groups were particularly interested in the apprehension of enemy agents and of local citizens who participated in partisan warfare or underground activities behind the Soviet lines.

Interrogations were always conducted by an officer. The prisoner was brought into a room where the interrogator and his interpreter sat behind a desk; an enlisted man stood guard at the

SECRET

SECRET

SECRET SECRET

door. Questions asked centered around the prisoner's personal background and the subversive activities of which he was accused. The interrogator was also interested in why a prisoner had participated in such activities. Treatment of the prisoner during interrogation seemed to depend upon the individual interrogator. Usually the prisoner received, as the source expressed it, "bad beatings," and the more ambitious the officer, the worse the beating. Questioning did not end until the prisoner signed a written confession. Apparently, to be accused was to be guilty, and many prisoners endured long hours of questioning and torture. The source responsible for this report said that he did not know of a single instance in which a prisoner once arrested by Smersh was set free, that the prisoners moved with the unit and were locked in cellars or houses under guard. In any event, Soviet soldiers were so thick in the army rear area that "it would have been practically impossible for anyone to stay free for any length of time."³²

While the foregoing discussion of the operations of a single Smersh unit is based on an isolated and unevaluated report, it has been given rather full treatment here because the report presents a realistic and what seems to be a reliable account of Smersh activities. Beyond mentioning the beatings that prisoners received, this source told of no other torture methods used

SECRET

SECRET

SECRET

SECRET

during interrogation, despite the fact that the prisoners always made "confessions."³³ Most information available on Smersh methods has emphasized the fact that large numbers of prisoners were shot after enduring their first Smersh investigation. Important prisoners were saved for questioning at higher headquarters, and others were spared if they showed promise of being of further use, either as sources of information or as "twisted-around"³⁴ agents for the Soviets.

Typical of the processing of many agents who were captured is the case of two agents who had been in the employ of the Germans and who were apprehended by a Soviet reconnaissance unit. They were evacuated quickly to battalion, to regiment, and then to division headquarters. Here they were interrogated by Smersh personnel, then sent to army for another thorough investigation, then to the front Smersh unit, and, finally, to GUKR NKO headquarters in Moscow. After a lengthy investigation, they were taken into Soviet employ and given a mission against their erstwhile German employers.³⁵

Red Army troops were under strict orders to turn over to the nearest Smersh unit any captives who were wanted by Smersh. Enemy agents, deserters, partisans, and the various other categories of prisoners in which Smersh was interested were separated from the others following their first screening after capture (usually

SECRET

SECRET

-252-

SECRET

SECRET

at battalion) and evacuated as rapidly as possible to division, which was the lowest echelon having a Smersh unit. Regulations required that Smersh interrogation centers be located far enough from division headquarters to guarantee secrecy.³⁶

Smersh units maintained their own stockades or kept prisoners in local jails commandeered for their use. A guard unit attached to each Smersh headquarters was used to guard and escort prisoners after they had been turned over to Smersh jurisdiction. Such prisoners were rarely seen or heard of again by other prisoners or by Red Army military personnel. Even if they survived the Smersh interrogations, such prisoners were sent to special "punishment" or "silent" camps. Later, most of them were convicted of war crimes and sentenced to long terms of hard labor in Soviet concentration camps. Practically none have been repatriated since the war.

For the training and guidance of its interrogators, GUKR NKO published a voluminous manual entitled "Questioning Instructions for the Interrogation of Apprehended Agents and German-Friendly Elements, and for the Checking of Indigenous Agents." The following brief discussion covers some of the most important points contained in this guide for Smersh interrogators.³⁷

As a counter-espionage agency, Smersh was primarily interested in learning details about German espionage service, personnel,

SECRET

SECRET

-253-

SECRET SECRET

and intentions. If the prisoner was a suspected agent, the first questions centered around the name of the prisoner and any alias he may have used in the past. Files were then checked to see whether any information had already been collected on this individual from previously captured agents or other sources, in which case his name was usually on a "wanted" list. Next, the subject was thoroughly interrogated about his recruitment for the German espionage service, his training for the mission, names of co-workers, and places where contacts with other agents and line-crossings were made. Answers to the detailed questions that were asked about the German espionage system enabled Smersh to take counter-measures against enemy spies and to place Smersh agents within the German organization.

Smersh interrogators subjected all prisoners whom they questioned to a detailed interrogation concerning the situation in Soviet territory currently held by the Germans. Questions centered around matters such as the reaction of the population to the German occupation, measures taken by the Germans either to win over or to suppress the local inhabitants, and the effect of German and of Soviet propaganda. Smersh investigators were particularly interested in collecting the names of Soviet citizens who voluntarily collaborated with the enemy and of German commanders or troop units responsible for the perpetration of atrocities.

SECRET SECRET

-254-

SECRET SECRET

Finally, all prisoners were subjected to detailed interrogations concerning morale, the German political propaganda program, and the military situation much the same as those conducted by the Political Directorate sections. Important and immediately useful combat intelligence secured in this phase of Smersh interrogations was usually communicated to the military intelligence officer of the headquarters to which the Smersh unit was attached.

A prisoner was often interrogated several times on important matters, and, if necessary, experts were brought in to conduct technical interrogations. After an interrogation, the interrogators often researched for data already on hand in their files on German organization, units, and names of known agents, and they compared the prisoner's statements with those made by previously captured agents. At the next interrogation, the prisoner was confronted with statements which differed from his on the same matters.

A basic rule employed by Smersh investigators was to give little credibility to information given by agents. A Soviet directive, for example, stated, "When receiving such statements, it is to be considered that the agents of the German Secret Service have been instructed to submit information which can lead astray or confuse. Therefore, strictest checking (for example, by cellmates) is advisable."³⁹

Information secured from prisoners by Smersh interrogators

SECRET SECRET

-255-

SECRET SECRET

was put to three general uses: (1) to promote more effective counterintelligence operations (by compilation of wanted lists and by being in possession of more complete knowledge of German espionage activities, methods, and organization); (2) to promote more effective Soviet espionage operations in German-held areas (by making use of information concerning German organization, methods, and security measures); (3) to promote more effective military operations against the Germans (by making use of the general military information concerning the enemy's situation, strength, and intentions).

In addition to the positive intelligence secured by Smersh investigators, data was collected regarding the relatives of the prisoners, particularly those of agents and of Russians who otherwise collaborated with the enemy, so that reprisals could be carried out later for purposes of revenge and intimidation. Reprisals usually took the form of sentences of five years at hard labor in Soviet prison camps.⁴⁰

During the first two stages of the war, prisoners interrogated by the counterintelligence units were usually shot when they showed no promise of being of further use as sources of information or as "twisted-around" agents. Such shootings continued to take place, but during the latter part of the war most of the prisoners, following interrogation, were turned over to the NKVD, which kept

SECRET SECRET

SECRET SECRET

them in special punishment camps. General treatment to be accorded prisoners by the OO NKVD was outlined in a basic order concerning treatment of prisoners issued in May 1942 (Supplement 10) by M. L. Beriya, Chief of the NKVD. (Policies changed little if any when the OO NKVD became GUKR NKO a year later.) Executions were sometimes conducted in a manner designed to warn or intimidate the local population and the troops. Most of the executions, however, took place secretly.

GUKR NKO, like the Main Political Directorate, was nominally a part of the Red Army, but actually took its directions from the Commissariat for State Security (NKGB) which, in turn, was a direct agency of the Communist party. A Smersh unit attached to a headquarters of the Red Army kept the intelligence staff section of that headquarters under especially close surveillance, and co-operation with that section in a matter such as the exchange of combat information took place on a personal basis between chiefs of sections rather than on an official basis as required action. Co-operation between Smersh and the NKVD was close and continuous.

C. Soviet Interrogation Methods Applied in Prisoner-of-War Camps

1. General Conditions in the Camps

The Soviet interrogation program in prisoner-of-war camps

SECRET SECRET

SECRET

SECRET

was intimately related to the general treatment accorded prisoners in those camps. Men who are starved, homesick, and overworked, who have been subjected for years to ruthless exploitation and to debilitating living conditions, who have been constantly spied upon by their comrades and who have lost hope of repatriation -- such men lose their pride and honor; they will betray a friend for a piece of bread and their ideals for a chance to go home. This discussion of camp-interrogation methods is, therefore, prefaced by this brief general discussion of prisoner-of-war camps in the Soviet Union. Considerable material is available on this subject, largely from Germans who have finally been repatriated to the western zone of Germany, but the material presented here must necessarily be limited to generalities.

NKVD prisoner-of-war cages were established at headquarters of armies in the field. There prisoners were turned over to the NKVD by the army and processed for shipping to the interior of the country. A certain amount of screening undoubtedly took place at the NKVD cage resulting in each prisoner's initial assignment to a specific camp, prison, factory, or other installation. When large numbers of prisoners were taken, as at Stalingrad or at the close of the war, it may be assumed that assignments were made at reception centers after a hasty screening had made possible the classification of each prisoner according to his rank, position,

SECRET

SECRET

-258-

SECRET SECRET

health, professional or technical skill or occupation, age, and political conviction or inclination. Huge numbers of unskilled laborers were needed by the Russians, and many prisoners capable of performing skilled labor were massed together with others to work on projects such as clearing rubble or building roads. Russia's need for technicians was so great, however, that prisoners with occupational skills generally found themselves assigned to appropriate tasks after the NKVD's classification system began to function efficiently.

Although the prisoners were sometimes forced to march, evacuation to the zone of interior was usually accomplished by train and was often carried out under conditions which caused the death of many and left others greatly weakened. This was particularly true during the winter, when prisoners, stripped of warm clothing, boots, and blankets by their captors, had to march or were crowded into unheated boxcars for days without adequate food or sanitary and medical facilities. So many prisoners were lost in this way that the Soviet high command took stringent measures to improve evacuation procedures, thus to insure a larger supply of labor. (See Appendix II.)

The NKVD operated all prisoner-of-war camps in the Soviet Union through its Main Directorate of Prisoner-of-War Camps. The all-important supervisor of each camp was the camp commander

SECRET

SECRET

-259-

SECRET

SECRET

(nachalnik) who had almost dictatorial power within his zone of responsibility and who was assisted by a small staff of officers. The Main Directorate of Interior Troops of the NKVD furnished guard personnel for the camps. (See Figure 7.)

Upon arrival at the first camp to which he was assigned and at every different camp thereafter, a prisoner was required to fill out a questionnaire. This form contained about forty questions covering such matters as vital statistics, military service, political affiliations, and the social and economic status of the prisoner and his family. Each questionnaire was added to the prisoner's dossier, and, if discrepancies were observed, new interrogations took place.⁴³ Prisoners sent to special NKVD prisons for interrogation or punishment were finger-printed, photographed, and otherwise processed as are criminals when being admitted to a penitentiary.⁴⁴

Enlisted men were massed together in separate camps with a minimum number of officers (with rank no higher than captain) assigned to perform necessary administrative duties. Officers were sent to special camps that were separated into those for company grade, for field grade, and for general staff and general officers. German medical personnel were distributed among both officers' and enlisted men's camps to administer to the medical needs of the prisoners.

SECRET

SECRET

-260-

SECRET

SECRET

Prison camps were scattered throughout the Soviet Union, locations being largely determined by the need for labor. The camps were generally established in the vicinity of a work project. Sub-camps similar to the main camps were set up when the distance to work was too far to be covered by daily marches. Some of these main camps with their subcamps were scattered over an area of several hundred square miles.⁴⁵ A small number of prisoners, usually highly skilled technicians, were billeted at their place of work, often under little or no guard.

The camps varied greatly in size and in their physical set-up according to location, the type of work project, and the availability of shelter. In many cases the prisoners were forced to build their own camps. Almost invariably there was too little shelter, and the prisoners lived in overcrowded huts or barracks where every available bit of space was utilized. In industrial areas prisoners were often billeted in brick factory buildings or wooden barracks. In more sparsely populated areas they lived in barracks or, in warmer regions, in tents. The most primitive type of billeting was found in forest areas where prisoners built their own earthen bunkers or rude huts with grass roofs. Washing and latrine facilities were normally in the open. The compounds of barracks or bunkers were surrounded by several barbed wire fences. Every camp had a jail or "punishment bunker;" this usually consisted

SECRET

SECRET

-261-

SECRET SECRET

(rachalnik) who had almost dictatorial power within his zone of responsibility and who was assisted by a small staff of officers. The Main Directorate of Interior Troops of the NKVD furnished guard personnel for the camps. (See Figure 7.)

Upon arrival at the first camp to which he was assigned and at every different camp thereafter, a prisoner was required to fill out a questionnaire. This form contained about forty questions covering such matters as vital statistics, military service, political affiliations, and the social and economic status of the prisoner and his family. Each questionnaire was added to the prisoner's dossier, and, if discrepancies were observed, new interrogations took place. Prisoners sent to special NKVD prisons for interrogation or punishment were finger-printed, photographed, and otherwise processed as are criminals when being admitted to a penitentiary.

Enlisted men were massed together in separate camps with a minimum number of officers (with rank no higher than captain) assigned to perform necessary administrative duties. Officers were sent to special camps that were separated into those for company grade, for field grade, and for general staff and general officers. German medical personnel were distributed among both officers' and enlisted men's camps to administer to the medical needs of the prisoners.

SECRET SECRET

SECRET SECRET

Prison camps were scattered throughout the Soviet Union, locations being largely determined by the need for labor. The camps were generally established in the vicinity of a work project. Sub-camps similar to the main camps were set up when the distance to work was too far to be covered by daily marches. Some of these main camps with their subcamps were scattered over an area of several hundred square miles.⁴⁵ A small number of prisoners, usually highly skilled technicians, were billeted at their place of work, often under little or no guard.

The camps varied greatly in size and in their physical set-up according to location, the type of work project, and the availability of shelter. In many cases the prisoners were forced to build their own camps. Almost invariably there was too little shelter, and the prisoners lived in overcrowded huts or barracks where every available bit of space was utilized. In industrial areas prisoners were often billeted in brick factory buildings or wooden barracks. In more sparsely populated areas they lived in barracks or, in warmer regions, in tents. The most primitive type of billet was found in forest areas where prisoners built their own earthen bunkers or rude huts with grass roofs. Washing and latrine facilities were normally in the open. The compounds of barracks or bunkers were surrounded by several barbed wire fences. Every camp had a jail or "punishment bunker;" this usually consisted

SECRET SECRET

SECRET SECRET

of a number of underground, solitary confinement cells which were unlighted and unheated.

Officers' camps, particularly for those of higher rank, were usually more comfortable and sometimes surpassed in quality those provided for Red Army personnel. Officers were on occasion permitted to mingle with local inhabitants, and there are reports of marriages taking place between German officers and Russian women. Camps where selected prisoners were sent for advanced political training (antifa schools) provided excellent accommodations similar to the best furnished for Red Army troops. There are also reports of so-called "model camps," some of which were former monasteries, where prisoners were held under ideal conditions and provided with clubs, recreation facilities, hospitals, and other luxuries. These camps were probably established for propoganda purposes (for instance, to show to Russian newsmen and foreign visitors).⁴⁶ In punishment camps, however, it may be assumed that prisoners suffered more rigorous living conditions than in the worst of the enlisted men's camps, but little information is available on these installations.⁴⁷ Quarters for Soviet administrative and guard personnel, as a rule, were much superior to those provided for the prisoners.

Living conditions varied greatly from camp to camp according to the climate, the type of work being performed, the availability of food, clothing, and fuel, the type of prisoners assigned to a

SECRET SECRET

SECRET SECRET

particular camp, and the dispositions of the individual camp commanders and their staffs. Many prisoners, while complaining of bad living conditions, have said that they received no worse treatment than the average Russian soldier or worker. In other camps, however, an appalling death rate among the prisoners was eloquent witness to the conditions which they were made to endure.

In the labor camps, prisoners slept on the floor or the ground or on plain wooden bunks, and they considered themselves fortunate when they had one blanket and a sack of straw for a mattress. Fuel was always scarce (except, perhaps, in the forestry camps), and prisoners lived for the most part in unheated quarters or were rationed small amounts of wood to burn in cans or crude stoves. In the colder parts of Russia, many prisoners froze to death or died from sicknesses brought on by continued exposure to cold. Practically all prisoners complained of the shortage of clothing. What few garments had been left to them when they were captured became ragged and dirty in the camps, and no issues of clothing and shoes were made until long after the war in most cases. Sanitation facilities were of the most primitive type. Swarms of flies were a constant nuisance, and practically all repatriates have mentioned with horror the great numbers of bedbugs, body lice, and other insects which infested their clothing and billets.

Food rations were inadequate, of poor quality, and incredibly

SECRET SECRET

SECRET SECRET

monotonous. One source, a repatriated German Army physician, said that immediately after the battle of Stalingrad, prisoners were given only about fifty grams of bread a day and, "as a result of undernourishment, an epidemic occurred in the winter of 1942-43 which cost the lives of many prisoners and Russian civilians." ⁴⁸ The same source stated that Stalin, alarmed by the epidemic and the high death rate in the prison camps, established a ration for prisoners in 1944 which provided a total of 2,300 calories per day for enlisted men and 2,500 per day for hard laborers and officer prisoners, a standard which was still inadequate and not met in most camps. Reports from a majority of repatriated Germans indicate that prisoners were fed a thin vegetable soup three times a day along with an issue of from 300 ⁴⁹ to 600 grams of black bread of very poor quality. Cigaretts were normally issued at the rate of one or two a day per prisoner and were made of shorka, the poorest quality of Russian tobacco.

Bad as the food situation was in the camps, the prisoner who could work was often, in theory at least, better off than the average Russian civilian or prison guard because of the liberal ration which had been authorized by Moscow for prison camps. Such a situation was bound to result in abuses as underfed guards stole prisoner rations and corrupt camp commanders diverted supplies into the black market. Another practice which aggravated the food

SECRET

SECRET

SECRET SECRET

situation was that of punishing prisoners who failed to meet the high work quotas by reducing their rations. As the prisoners grew weaker, their production dropped still lower -- a vicious system from which the escape was usually death. Disciplinary arrest was common, and prisoners confined in the "punishment bunker" were often systematically starved.

Undernourishment competed with epidemic diseases as the principal cause of the high death rate among the prisoners. Finally, control commissions were sent from Moscow in 1945 to investigate the food situation in the prisoner-of-war camps but it was not until late 1946 that the food rations began to improve. In some cases prisoners received a little pay for their work, but during the war there was little or no way of purchasing extra food. The Russians took advantage of the situation by offering extra food as a means of inducing prisoners to engage in pro-Soviet political activity or to become stool pigeons.

Beginning in 1947, prisoners began to receive a fairly substantial wage for their work. A large portion of their pay was deducted for living expenses, but with what remained they were able to buy small amounts of food and other items. After the currency conversion reform in December 1947, prisoners were able to buy food at official prices. This improved the situation for prisoners to a marked degree, although many prisoners noted little change until 1949. ⁵¹

SECRET

SECRET

SECRET SECRET

All prisoners were required to work, with the exception of the very sick and officers with the rank of lieutenant colonel and above. The Russians were determined to get as much work as possible out of prisoners, and in heavy labor camps, quotas (norms) were set which most prisoners could not meet. Camps where the prisoners worked in stone quarries, in lumber mills, at road construction, excavating, and mining often became "death-camps." Prisoners were made to work from eight to fourteen hours a day, six days a week, after which they were often required to attend propaganda lectures and political meetings. Skilled prisoners who worked in factories fared much better than those in the heavy labor camps. They could usually surpass the Russian workers in production, and many native laborers were actually apprenticed to prisoners in order to learn their trades. Until May 1947, skilled prisoners were used in all types of production, but it appears that orders went out then restricting prisoners to work on building construction, transport, and general labor. The hurried management of many factories, worried about quotas, bribed camp commanders to let prisoners remain on the job at their plants.

Medical facilities and supplies at the camps were, generally speaking, entirely inadequate. A few repatriates, however, have made conflicting statements on this matter, saying that medical services in their particular camps were good. In the beginning,

SECRET SECRET

-266-

SECRET SECRET

German medical personnel, while held responsible, were forced to work under the supervision of Russian doctors whose professional standards were very low. In 1947, German doctors were given a free hand, serums and other medicines (and food) became more plentiful, and the health in the camps improved. To reiterate, throughout the war and the year immediately following the death rate in most camps was very high. Those who did not die from starvation, overwork, or exposure were weak, and they fell easy victims to epidemics which swept through the camps. The most common epidemic diseases were diphtheria, typhus, cholera, spot fever, and malaria. Hospitals for isolating prisoners with contagious diseases were provided in some camps, but they were of little value because of the crowded conditions in the barracks which permitted diseases to spread quickly. Neither could much be done for prisoners who were simply starving to death. Dysentery, edema, dystrophy, and other conditions brought on by malnutrition or improper diet took a heavy toll. It was not uncommon for a camp of hundreds of men to be reduced to a mere handful within a few months.

About once a month, prisoners in some camps were mustered for a cursory medical examination and divided into six classes ranging from healthy to very sick. The first two classes were required to work eight or more hours a day; classes three and four had to

SECRET SECRET

-267-

SECRET SECRET

work six and four hours a day, respectively; class five, "OK" (Ohne Kraft - without strength), was made a convalescent company; class six consisted of those suffering from extreme malnutrition (dystrophy - progressive muscular atrophy). Classes five and six did not have to work and were put on a ration of 3,000 calories per day. In one camp in 1947, 125 out of a total of 700 survivors of Stalingrad fell into the last two categories.⁵⁵

Since the war, Soviet leaders have made the charge that the high death rate among prisoners was the fault of the German physicians. The fact is that Soviet officials often preferred German physicians to their own, and many Russian doctors eagerly tried to increase their professional knowledge and skill by working with German medical personnel among the prisoners.⁵⁶

The number of prisoners who died in Soviet prisoner-of-war camps during and after World War II will probably never be known. That the death rate was high is indicated by the following excerpts from various reports and an Associated Press news item.

- a) PW Camp Stalin, No. 26. The average number of German prisoners in this camp was around 3,000; the average number of deaths per month from the summer of 1945 to the summer of 1946 was between 160 and 170.⁵⁷
- b) PW Camp Kaunas, No. 54. Out of 3,100 German prisoners in this camp, 800 died during the winter months, January-April, 1946.

SECRET SECRET

SECRET SECRET

- c) Based on reports from German soldiers captured at Stalingrad, it is estimated that only six to seven thousand of the original 90,000 were still alive on 30 April 1947.
- d) During the winter of 1945-46 at Suchmi, of a camp membership of approximately 800 approximately 80 are reported to have died of illness and malnutrition. A German and a Russian doctor were available, but no medicines or other medical supplies were provided.⁵⁸
- e) The West German Government sent two officials to the United Nations 20 Oct 1950 with what it considered documentary evidence that a million German prisoners of war and civilians abducted from East Germany died behind the Iron Curtain.⁵⁹

Supervision in the camps was severe, especially during working hours when guards and foremen drove the prisoners hard in an attempt to meet quotas. Poorly clad prisoners were forced to work long hours in below-zero weather; frozen limbs and frostbite were common. Beatings and other forms of mistreatment were officially forbidden, but they took place frequently in most camps, especially during interrogations.

While some guards were sadistically cruel, others were surprisingly good-natured and inclined to fraternize. Some of the guards, afraid to air their grievances before their comrades, unburdened themselves to friendly prisoners and collaborated with them in committing petty thefts of food or of goods which could be blackmarketed. When laxity was noticed by the camp commandant, however, the easy-going guards disappeared. Guard details were

SECRET SECRET

SECRET SECRET

systematically rotated in many camps to prevent any possibility of friendships growing up between guards and prisoners. The local population and Russian workers in the factories were generally hospitable, friendly, and kind when they came in contact with prisoners. Although most reports emphasize that the treatment of prisoners was severe, practically all repatriates have agreed that, left to himself, a Russian was an understanding, sympathetic, fellow, but when another Russian was present, his behavior assumed an entirely different pattern. A number of repatriates have said that their lot as prisoners had been no worse⁶⁰ on the whole than that of the average Russian farmer or worker.

Escape from camps was very difficult to accomplish. Security measures were strict, not only in the camps but throughout the country. Travel, even for short distances, has been carefully controlled in the Soviet Union, and the presence of any stranger excites immediate attention from local authorities. Large gangs of prisoners frequently worked on projects outside of camp limits with little or no supervision from Soviet personnel.⁶¹ To escape from camps into the wastes of Siberia was almost equivalent to committing suicide by starvation or exposure; the local inhabitants of such areas were paid a bounty for returning escapees to the authorities. Trained dogs, hungry and savage, were often used to patrol the periphery of the camps or to track down escaped prisoners.

SECRET SECRET

SECRET SECRET

Labor camp personnel were organized into companies and battalions with prisoner-leaders who had been selected by the camp commandant. These leaders received more food, better clothing, and other privileges and were usually opportunists who had thrown in their lot with the Soviets. Most of them were sent to special camps for political training, and then returned to the labor camps to lead, propagandize, and spy on their fellow countrymen. This personnel, rather than the ranking prisoners, formed the official prisoner administration of each camp through which the camp commandant issued orders to the prisoners (and, theoretically, through which he received petitions, complaints, and recommendations from the prisoners). Most repatriates have complained that this group of privileged collaborationists was often more tyrannical and cruel than the Soviet personnel in the camps.

In practically all camps, prisoners were forced to participate in the political education or propaganda program known as Antifa (anti-fascist) training. In most camps, the authorities attempted to make it appear that participation in the program was spontaneous and voluntary, but prisoners who failed to participate were punished directly or found themselves discriminated against in work assignments and rations or in other obvious ways. The propaganda program was dropped at the end of the war but was taken up again with renewed intensity in 1947, apparently in an attempt to convert as

SECRET

SECRET

SECRET

SECRET

many prisoners as possible before they were repatriated. Fear of non-repatriation forced a majority of the prisoners to simulate an enthusiasm for the program.

Evening meetings were held, on the average, twice a week. At these meetings, prisoners listened to lectures on Marx, Lenin, and Stalin; on the history and theory of communism; and on the glories of the Soviet way of life. During the war, prisoners heard constant diatribes against Hitler and nazism; after the war, diatribes against America, England, and other capitalistic powers. Some of the meetings consisted of readings from books, magazines, and from the camp newspaper which was published (under the careful eye of a Russian censor) by the antifa organization in the camp. At other times the meetings became discussions which the leaders attempted to give the appearance of democratic forums. At first the meetings were led by Soviet political officers or German Communists who had been in Russia for several years before the war; later the program was turned over largely to collaborating prisoners who had been sent to the antifa schools for terms of six weeks, three months, or longer.

The majority of the prisoners were too tired to care what went on at the meetings. Many of the "canned" lectures were incomprehensible to both lecturer and audience. Most prisoners, even those who did not care for nazism, were not taken in by Soviet

SECRET

SECRET

-272-

SECRET

SECRET

propaganda -- they were in Russia and knew too well the truth about the Soviet way of life. About ten percent of the prisoners participated actively in the antifa program, went to the antifa schools, and acted as leaders and stool pigeons in the camps. They did not have to work but received pay, better rations, clothing, and quarters, and occupied privileged positions in the camps. Many were repatriated upon completion of their antifa courses, presumably to form the nucleus of an underground communist movement in Germany or to act as espionage agents for the Soviet Union. Former German Communists and fellow-travelers were the first to join the movement, a few Germans were truly converted to the Soviet cause (that is, to communism), but the majority of the antifas, or "activists" as they were called, were unprincipled opportunists who seized this method of improving their lot or of insuring their early repatriation. With living conditions as bad as they were in most camps, it is only surprising that more prisoners did not join the movement.

One prominent German observer has estimated that only one or two percent of the German prisoners were sincere participants in the antifa program and will continue to work underground for the Soviets in Germany.⁶² Thus, while the Soviet propaganda program cannot be considered an entire success from the Soviet point of view (they started the program with the intention of converting

SECRET

SECRET

-273-

SECRET SECRET

all prisoners to their way of thinking), neither can German or Allied authorities dismiss lightly the danger presented by the corps of well-trained, fanatic followers of the Soviets which has been repatriated to postwar Germany. Neither can the effects of Soviet propaganda on the minds of returned prisoners be discounted should widespread unemployment and destitution strike the German people.⁶³

Generally speaking, it can be said that conditions in Soviet prisoner-of-war camps were bad during the first stage of the war, steadily improved during the second and third stages, were extremely bad during the fourth stage (to the extent that prisoners called this stage the "punishment years"), and improved greatly during the fifth stage.

To summarize, aspects of life in Soviet prisoner-of-war camps which contributed to the success of the interrogation program were (1) low living standards, overwork, and starvation which sapped the strength and broke the will of most prisoners, making them willing to do or say almost anything in return for better living conditions and food; (2) the system of surveillance conducted by prisoners who were coerced or who sold themselves into the role of informers on their fellows; (3) the atmosphere of fear which permeated the camps -- fear of betrayal by a comrade, fear of unjust punishment, fear of arrest, fear of being interrogated,

SECRET SECRET

SECRET SECRET

and fear of non-repatriation.⁶⁴

In some ways, fear of non-repatriation overshadowed all other factors in the day-to-day life of the prison camps. Soviet interrogators found that one of their strongest methods of persuasion with prisoners was to threaten deferment of repatriation.⁶⁵

According to a German writer on the subject:

The prisoner of war has one aim. He wants to go home as soon as possible. This desire becomes more emphatic as he begins to realize the difference between his own country and the country in which he is held prisoner. He soon learns to focus all his thoughts and deeds on this aim. Eyes and ears are at attention, kept in a state of alert. Inventive and deceptive acts become a matter of daily life. Nobody made this life of pretense so much his own as the prisoner in Russia. The prisoner had to accept propaganda if he did not want to spoil his chances of being returned home. His inner feelings were opposed to the many catch phrases, and he was indifferent to the accompanying circumstances.⁶⁶

2. Camp Interrogation Methods

a. The Five Phases of the Camp Interrogation Program

The Soviet interrogation program in prisoner-of-war camps was more simple in some ways than the field interrogation program. Although camp interrogations were more extensive in their scope and could be carried on for an indefinite length of time, they were conducted by only one agency, the NKVD, as compared with the three or four agencies which conducted interrogations in the field. Several governmental agencies participated in the camp investigations but the NKVD was the responsible agency which controlled

SECRET SECRET

SECRET

SECRET

and co-ordinated the program. This centralization of direction and effort resulted in greater efficiency and permitted the establishment of a comparatively simple organization to handle the program. The situation also permitted uniform training of interrogation personnel and the adoption of standardized procedures throughout the prison-camp system. Despite the centralization of control, a considerable number of minor variations of procedure have been noted, but, on the whole, the procedures which had been put into practice by 1943 prevailed in the camps during the remainder of the period covered by this study.

Unlike most nations, which end their prisoner-interrogation programs with the close of hostilities, the Soviet Union continued interrogations with unrelaxed intensity into the postwar period. The only change was in the purpose for which the interrogations were conducted; such a change in 1947 led to an increased pace in the program.

Despite the continuity of organization and method, there were certain differences in the Soviet camp-interrogation program during each phase of the war and the postwar period. The brief discussion of characteristics of each of the five phases which follows will precede the more detailed description of camp-interrogation practices.

Little information is available on the Soviet camp-interrogation

SECRET

SECRET

-276-

SECRET

SECRET

program during Phase I of the war (June 1941 to the spring of 1942). Few prisoners were taken during this period; not many of those survived the early stages of their capture, and, save for a very few escapees, practically none survived the hardships of the years that followed. Reports by escapees indicate that the Soviets had no organized camp-interrogation program at the beginning of the war. It is known that some German officers were interrogated during this phase. Such interrogations were conducted by Red Army officers and by civilians who may or may not have been representatives of the NKVD. A majority of the prisoners, however, were interrogated in the camps only after a lapse of several months -- that is, after the beginning of the second phase.⁶⁷ The German officers who are known to have been interrogated were questioned principally on matters pertaining to their personal histories and were not pressed to reveal information on the military situation. They were not mistreated; on the contrary, they were accorded military courtesies customarily extended to officers who have been captured. The principal aim of the Soviets at that time seemed to be to alienate German prisoners from Hitler and nazism and to create a sympathetic attitude toward the USSR by means of propaganda.

During the Phase II of the war (spring of 1942 until after Stalingrad), the NKVD definitely took over the camp-interrogation

SECRET

SECRET

-277-

SECRET

SECRET

program. This organization already had much experience in dealing with domestic prisoners, and this, combined with experience gained in dealing with prisoners of war, enabled the NKVD to perfect an organization for conducting camp interrogations which apparently remained unchanged in its basic details throughout the remaining phases. More and more uniformly trained interrogation personnel became available during the second phase, and methods of interrogation approved and directed by the NKVD were put into practice in camps and prisons throughout the Soviet Union. While minor variations of method have been reported, the interrogation procedure adopted and perfected during the second phase of the war became characteristic of NKVD methods from that time on. Interrogations consisted of exhaustive investigations of each prisoner's personal history. The prisoners were also required to reveal every possible bit of information in their possession concerning the German Army and the political-economic situation in Germany. Attempts were made to discover officers with special technical or tactical experience and experts in various fields of science, industry, and economics.

During the Phase III (1943 to the close of hostilities), the Soviets had available large numbers of German prisoners, and the carefully planned interrogation system which had been established in 1942 became fully effective. Before Stalingrad, the Soviets

SECRET

SECRET

SECRET

SECRET

theoretically had at their disposal between 80,000 and 100,000 Germans, but at least half of these had perished before any extensive interrogations could have taken place. After Stalingrad, huge numbers of prisoners were taken, and, since they were valuable as labor, their lives were more carefully preserved. The centralized interrogation system had been set up on an excessively large scale, considering the number of prisoners available in 1942, but now the system began to yield rich rewards. All information gained from prisoners by interrogation, including information collected by agencies in the field, was collected by one centralized agency, the NKVD, which may be given full credit for making use of this information to formulate accurate and comprehensive strategic estimates of the enemy situation. The efficiency of the interrogation system improved rapidly as personnel became more experienced, but there were no major departures from the organization or the methods which had been established during the second phase.

Phase IV (June 1945 to the fall of 1947) was marked by an immediate and severe deterioration in the treatment accorded prisoners of war by the Soviets. Hundreds of thousands of Germans who surrendered en masse after the capitulation were herded into prison camps and forced to work for the Soviet Union. The principle of the collective guilt of the German people formulated by the Allies was used by the Soviets as a pretext to treat the prisoners

SECRET

SECRET

SECRET SECRET

as outlaws. Thousands were massacred upon surrender, and other thousands died in the camps from overwork, starvation, exposure, disease, or violence at the hands of guards and interrogators. The pro-Soviet propaganda program was practically dropped during this phase.

Since tactical and political interrogation in the field ended with the close of hostilities, the NKVD now had entire control of the interrogation program. Although the war had ended, interrogations continued with an even increased intensity. The methods used by interrogators and the organization for conducting camp interrogations remained the same.⁶⁸ There was a change, however, in the subject matter of the interrogations. Freed from the necessity to secure minute details of information relative to Germany's war effort, Soviet interrogators turned their attention to general aspects of the war which had just ended and to future eventualities. Large-scale investigations began on such matters as German opinions, conclusions, and experiences with respect to Allied armies; the characteristics, effect, and combat efficiency of Allied weapons; Allied tactics; German opinions of Russian weapons and tactics; and a complete history, battle by battle, of the war against Russia from the German point of view. All specialists among the prisoners were forced to reveal every bit of special knowledge which they possessed. Western Europe's

SECRET SECRET

SECRET SECRET

entire economy was thoroughly investigated, and special attention was devoted to anything the prisoners knew about the U.S. Army and American industry.

During Phase V (fall of 1947 to 1950), the Soviets began to repatriate prisoners in accordance with an inter-Allied agreement, although they were far short of completing the process by the end of 1948 as specified in the agreement. Conscious of a last direct opportunity to propagandize prisoners, the Soviets revived the antifa program with new intensity; living and working conditions for prisoners were improved, and they were treated with more consideration than at any time in the past. Most of the prisoners simulated an enthusiasm for the antifa program to insure their repatriation.

Interrogations continued, with diminishing returns, along the same lines pursued in the fourth phase. During the fifth phase, however, the emphasis in the interrogation program shifted to the search for "war criminals." This was not a new aspect of Soviet interrogation. Attempts had been made throughout the war to discover Germans guilty of atrocities or other crimes against the Soviet Union. The emphasis on the program during the fifth phase, however, was unprecedented. Large numbers of prisoners, hitherto regarded as innocent of any wrong doing, were suddenly accused of war crimes, tried in Soviet courts (often *in absentia*),

SECRET SECRET

SECRET

SECRET

convicted, sentenced to long terms of hard labor, and deported to concentration camps for common criminals. Such action deprived the convicted individuals of their status as prisoners of war and gave a similitude of legality both to their retention in the Soviet Union and to the Soviet claim that all "prisoners of war" had been repatriated.

There are two ostensible reasons why the Soviets abruptly adopted this course of action: (1) to retain as many slave laborers as possible, and (2) to prevent the return, particularly to West Germany, of certain classes of Germans who could not be expected to be pro-Soviet and who would be of special value as potential leaders in the economic rehabilitation of their country or in a revival of German military power.

In order to carry out their plan, the Soviets defined the term "war crime" so broadly that large numbers of prisoners automatically became war criminals. (For example, any prisoner who had been assigned to any one of a large number of German military units was guilty of a war crime because of atrocities alleged to have been committed by those units.) Records of the prisoners were screened, and appropriate charges were filed against prisoners whom the Soviets desired to retain. If nothing could be found in a specific prisoner's record which would serve to form the basis for a charge, the Soviets, nevertheless, accused that prisoner

SECRET

SECRET

SECRET

SECRET

of some war crime and forced him to admit guilt. In many instances, other prisoners were suborned or forced to bear witness against the accused prisoner.

b. Administration of the Camp Program

Little information of an exact nature is available on the organization within the NKVD which conducted the camp-interrogation program. The highest echelon of this branch of the commissariat was located in Moscow and, so far as is known, was a subdivision of the Main Directorate of Prisoners-of-War Camps. (Figures 6 and 7.) Only assumptions can be made about the organization within that subdivision. Since files were undoubtedly maintained on literally millions of individual prisoners, not to speak of order-of-battle and other informational files, cross-indexing must have required the services of several hundred individuals.⁷⁰ It must also be assumed that the subdivision directed the interrogation program in camps and special prisons, recruited, trained, and assigned personnel within the scope of its activities, and maintained liaison with numerous agencies of the Soviet Government.

The Soviet Union was divided into districts for purposes of administration, and all prisoner-of-war camps in each district were responsible to the District Directorate of the Affairs of Prisoners and Internees which, in turn, was directly responsible to the Main Directorate in Moscow. (Figure 7.) The camps were

SECRET

SECRET

SECRET SECRET

subdivided for purposes of locating groups of prisoners near work projects as described earlier in this study. These subdivisions were frequently as large or larger than the main camp of an area within a district.

Exact details are lacking on the organization of the interrogation program at district level. The Operations Officer on the staff of the District Directorate is known to have been responsible for all interrogations and investigations in the district. He directed the activities of the interrogation teams in all camps of the district and, presumably, operated a collection, evaluation, and administration center at district headquarters.

Details are also lacking on the organization of camp interrogation teams. Such units undoubtedly varied in size according to the size of the camps and the needs of the moment. It may be assumed that tables of organization for the teams were flexible and provided for a minimum number of interrogators, interpreters, trained intelligence personnel, file-clerks, and typists. Technicians or experts in various fields of knowledge were assigned as needed to accomplish specific tasks. The commanding officer of a team was usually of field grade rank, and interrogators ranged in rank from junior lieutenant to major. The NKVD interrogation teams operated on a semimilitary basis; personnel wore uniforms, and the system of ranks and ratings corresponded to that of the

SECRET SECRET

SECRET SECRET

Red Army. It may be assumed that one team was assigned to each main prisoner-of-war camp, and personnel from that camp was sent to conduct interrogations in the sub-camps as needed.

Although the NKVD was responsible for camp interrogations, many other agencies took minor parts in this program. Again, it must be assumed that any other agency wishing to conduct interrogations in the camps or to screen prisoner records did so only when authorized by the NKVD. In some few instances, no doubt, higher authority ordered special investigations, in which case NKVD teams in the field were ordered to co-operate with the special investigators or to give them a free hand.

The principal agency which conducted interrogations in camps other than the NKVD was the NKGB. Most prisoners could not distinguish between NKVD and NKGB personnel. This is easily understandable since until 1943 the NKGB had been a main directorate of the NKVD (the GUGB); consequently, personnel of both organizations had been trained in the same schools, wore similar uniforms, used the same methods, and were interested to a certain extent in the same information. NKGB interrogators in the camps concerned themselves principally with the same categories of prisoners in which Smersh had been interested in the field -- suspected agents, German intelligence and counterintelligence personnel, former interrogation personnel, men who had been assigned to "native"

SECRET SECRET

SECRET SECRET

units or the so-called Osttruppen, and other prisoners who had participated in activities of interest to Soviet counterintelligence. Of primary interest to the NKGB were not the German prisoners themselves but the contacts those prisoners had had with Soviet citizens (collaborators and agents).⁷¹

Various industrial ministries vitally interested in the exploitation of prisoner-of-war labor sent interrogation teams to the camps in a search for technicians, specialists in various fields of ordnance, skilled workers, and scientists among the prisoners. These teams were made up of experts in their respective fields and were authorized to visit certain camps, to screen prisoner records, and to interrogate selected prisoners. Such interrogations took the form of job interviews in most cases. A majority of skilled workers and technicians were sent to appropriate industrial installations where they were employed as workers and supervisors; many of them were entrusted with considerable responsibility in the improvement of Soviet production methods or in the training of less skilled Russian workers. Scientists and many of the technicians among the prisoners were subjected to long interrogations and were required to write long papers in attempts to extract from them every bit of specialized knowledge they possessed. Individuals who had special knowledge on matters in which the Soviets were particularly interested (rocket and

SECRET

SECRET

SECRET SECRET

tank production, for instance) were transferred to special interrogation camps. (Camp 7027 and its sub-camps near Moscow is known to have been a special institution of this sort.)

Little if any pressure was exerted to make the skilled workers and technicians co-operate in the Russian industrial program. When an industrial interrogation team discovered a German prisoner with skills which were needed in Russian industry, the "interrogators" usually promised the prisoner many special privileges -- better food, pay, better living conditions, a measure of freedom -- if he would co-operate. Conditions were so bad in most of the ordinary camps that prisoners were nearly always glad to accept such opportunities.

The Soviet Foreign Ministry was interested in questioning prisoners who had ever served as attaches or held positions in the German diplomatic service. Such prisoners were transferred to Butnilka Prison in Moscow (capacity, 14,000 prisoners) where they enjoyed somewhat better treatment than most prisoners.⁷²

Although the NKVD was primarily responsible for discovering prisoners guilty of war crimes, the Soviet judiciary participated at times in this program. The NKVD district operations officer co-ordinated his war-crime investigation program in some instances with the district prosecutor. In most instances after the war the MVD was the sole conductor of the investigations, and prisoners

SECRET

SECRET

SECRET SECRET

were tried and convicted of war crimes by MVD tribunals.⁷³ Interrogations conducted in the camps by other than NKVD personnel were the exception rather than the rule. The NKVD conducted all initial interrogations as well as many special investigations requested through proper channels by other agencies.

c. General Methods of Interrogation

It will have been noted that the Soviets used interrogation not only as a means of gathering information but also as a means of attaining certain economic and political ends. Methods employed varied to a certain extent according to the purpose of an interrogation, according to the interrogator, and according to the specific prisoner under interrogation. The remaining portion of this chapter will consist of a detailed exposition of those methods.

Interrogation, in its most elementary form, consists simply of conducting an examination of a person by means of oral or written questions. Prisoner-of-war interrogation is complicated by the fact that normally a prisoner is unwilling to answer most questions because of continued loyalty to his country. The interrogator, therefore, is faced with the necessity of employing some means either to make the prisoner willing to talk or to trick him into revealing the desired information.

SECRET SECRET
-288-

SECRET SECRET

Coercive Techniques

Interrogations conducted as a part of a combat or strategic intelligence plan are confined, by nature of their purpose, to a search for true facts. The application of duress during such interrogations may defeat their purpose since a prisoner not in possession of desired information may fabricate answers to questions simply to gain respite from torture. Soviet interrogations conducted for the purpose of "discovering" war criminals or for gaining acquiescence to an anti-Nazi movement were not true interrogations in most cases since the desired end was to prove alleged charges against prisoners or to force consent to a course of action rather than to ascertain true facts.

During the great purges of the late 1930's the NKVD had been in charge of investigations which had resulted in many startling witness-stand confessions by former Soviet leaders; therefore, this organization, now the MVD, entered the fifth phase of the prisoner-of-war interrogation program with a broad background of successful experience in the field of obtaining "confessions" from domestic prisoners who had been unwilling, at first, to incriminate themselves. The same techniques were applied, with equal success, in forcing prisoners of war to confess to war crimes or in making prominent German prisoners lend their names to anti-Nazi propaganda.⁷⁴

SECRET SECRET
-289-

SECRET SECRET

were tried and convicted of war crimes by MVD tribunals.⁷³ Interrogations conducted in the camps by other than NKVD personnel were the exception rather than the rule. The NKVD conducted all initial interrogations as well as many special investigations requested through proper channels by other agencies.

c. General Methods of Interrogation

It will have been noted that the Soviets used interrogation not only as a means of gathering information but also as a means of attaining certain economic and political ends. Methods employed varied to a certain extent according to the purpose of an interrogation, according to the interrogator, and according to the specific prisoner under interrogation. The remaining portion of this chapter will consist of a detailed exposition of these methods.

Interrogation, in its most elementary form, consists simply of conducting an examination of a person by means of oral or written questions. Prisoner-of-war interrogation is complicated by the fact that normally a prisoner is unwilling to answer most questions because of continued loyalty to his country. The interrogator, therefore, is faced with the necessity of employing some means either to make the prisoner willing to talk or to trick him into revealing the desired information.

SECRET

SECRET

SECRET SECRET

Coercive Techniques

Interrogations conducted as a part of a combat or strategic intelligence plan are confined, by nature of their purpose, to a search for true facts. The application of duress during such interrogations may defeat their purpose since a prisoner not in possession of desired information may fabricate answers to questions simply to gain respite from torture. Soviet interrogations conducted for the purpose of "discovering" war criminals or for gaining acquiescence to an anti-Nazi movement were not true interrogations in most cases since the desired end was to prove alleged charges against prisoners or to force consent to a course of action rather than to ascertain true facts.

During the great purges of the late 1930's the NKVD had been in charge of investigations which had resulted in many startling witness-stand confessions by former Soviet leaders; therefore, this organization, now the MVD, entered the fifth phase of the prisoner-of-war interrogation program with a broad background of successful experience in the field of obtaining "confessions" from domestic prisoners who had been unwilling, at first, to incriminate themselves. The same techniques were applied, with equal success, in forcing prisoners of war to confess to war crimes or in making prominent German prisoners lend their names to anti-Nazi propaganda.⁷⁴

SECRET

SECRET

SECRET

SECRET

The most direct means of making an unwilling prisoner reveal information is, of course, to employ coercion. Modern international law forbids the use of coercive methods of interrogating prisoners of war. As has been noted, however, the Soviet Union was not signatory to the appropriate conventions nor was it sensitive to world opinion, and Soviet interrogators made extensive, not to say highly imaginative, use of coercion. This method may take a great variety of forms: threats of torture, of death, or of harm befalling one's family; confinement; hard labor; narcosis; physical and mental torture; and slow starvation -- to name but a few.

Despite the directness of coercion as a means of interrogation, it is not necessarily the most effective method to secure desired results, especially with strong-willed, determined prisoners who as soldiers have already risked their lives for their country on the battlefield. Neither is it the most desirable method for gaining accurate information since, as has been noted, a tortured prisoner may pretend knowledge and give false information in order to satisfy his tormentors and secure relief from pain.

Soviet interrogators used many forms of coercion to make prisoners talk, and their methods in this respect were often spectacular, particularly when a "confession" rather than true information was desired. It must be emphasized that Soviet

SECRET

SECRET

-290-

SECRET

SECRET

interrogators were aware of the limitations of coercion and used many other less direct methods. Descriptions of coercive methods which will subsequently be presented may, because of their spectacular quality and great variety, seem to be more dominant in the Soviet interrogation program than was actually the case.

A method of interrogation related to coercion and favored by the Soviets was to accuse the prisoner of lying. The usual procedure was to confront the prisoner with some discrepancy in his previous testimony and then to threaten dire punishment unless the prisoner elaborated upon his statements in order to prove that he had been telling the truth.

Indirect Techniques

Indirect methods of interrogation are, as a rule, tolerated by international law and were used by military intelligence interrogators of all belligerents during World War II. Any person who attempts to trap another into divulging information which the latter would not otherwise consciously reveal is practicing the ancient and highly developed art of indirect interrogation. It is doubtful that any World War II belligerent contributed anything that was basically new to the art. In this study can be listed only those methods which seemed to be favored by the Soviets, along with any adaptations and refinements of those methods which seem to be peculiar to Soviet ideology or Russian genius.

SECRET

SECRET

-291-

SECRET

SECRET

Indirect methods employed in the interrogation of prisoners of war involve the use of psychology, deceit, and monitoring devices. If the prisoner will not talk because of loyalty to his country, an interrogator may attempt to undermine that loyalty by use of propaganda. With many prisoners the most successful method may be to use a comradely approach in which interrogation takes the form of a friendly, sympathetic chat during which the prisoner, plied with cigarettes, food, and liquor, unwittingly reveals information. Promises of favored treatment in return for information appeals to opportunists among prisoners. Other stratagems may be employed, according to the character of the prisoner, such as appealing to the individual's vanity if he is egotistic, challenging his statements if he seems cocksure of his knowledge, or observing the prisoner's verbal and physical reactions to statements made by an interrogator who pretends to have complete information on a subject under discussion.

Included in the category of indirect methods was the monitoring of prisoner's conversations by means of mechanical devices such as hidden microphones. This actually was used very little by the Soviets during World War II, probably because of a shortage of the necessary equipment.

Another method of gaining information which might possibly be classed as an interrogation method was to encourage the prisoners

SECRET

SECRET

-292-

SECRET

SECRET

to write letters to their families. Few of these letters were sent out of Russia (at least, not before 1947) but were read carefully by Soviet translators who checked information gleaned from the letters against information already available on the prisoners.

The Use of Informers Among Prisoners

The Soviets made extensive use of stool pigeons and agents among the prisoners not only to gather information but also to provoke disparaging remarks from prisoners.⁷⁵ Interrogators frequently made good use of this information gathered by stool pigeons, especially when the prisoner could be confronted with information which differed from that which had been obtained from him in previous interrogations. A prisoner who made disparaging or threatening remarks before a stool pigeon could expect severe punishment, and the threat of punishment was often used as a lever to force the prisoner into the role of a stool pigeon.

Some of the informers were highly trained Soviet intelligence personnel who spoke German fluently and who were almost impossible to detect; they were treated by the guards with even more severity than other prisoners and were transferred frequently from camp to camp. Many German collaborationists who had been sent to advanced antifa schools were given special training as informers

SECRET

SECRET

-293-

SECRET SECRET

and sent to camps where they were not known. Others were German prisoners who were recruited by means of threats or promises of extra privileges. Among the latter group were many weak opportunists who volunteered for their roles in order to gain favor with their captors and who often used their positions to wreak petty vengeance on fellow prisoners whom they disliked. An effective method frequently used in recruiting unwilling prisoners as informers was to threaten the safety of their close relatives, particularly when the relatives lived in that part of Germany occupied by the Russians. Soviet doctors, medical aides, and nurses often gained the confidence of sick prisoners and secured information which the prisoners would not have otherwise revealed.

Prisoners of the Soviets soon learned that they could trust no one. They found that they could not even confide secrets in their closest friends. Even if the "friend" did not turn out to be an informer, the secret might be wrung from him in a subsequent interrogation. The most honorable and conscientious of prisoners could almost always be made to reveal information by Soviet interrogators when the latter were determined to make the prisoner talk. Such a prisoner was not given the choice between silence or death -- he was made to suffer until he talked.

SECRET SECRET

-294-

SECRET SECRET

d. Specific Methods of InterrogationFirst Phase of the War

The limited information available on Soviet interrogations in prisoner-of-war camps during the first phase of the war indicates that the Red Army was in charge of the interrogation program at that time and that only officers among the prisoners were interrogated. A typical case history from this period is that of two German officers -- an observation plane pilot and his artillery observer -- who were captured after being shot down behind Russian lines late in November 1941. Both of these officers escaped during the winter of 1942-43 and made a complete report of their experiences to German authorities. A summary of their experiences, as compiled by a German officer who studied the report, is quoted here in full.

Both officers were well treated. They were permitted to keep their uniforms, rank insignia, and decorations. After a brief interrogation by Russian forward headquarters concerning the situation, morale, etc., of the German troops, both prisoners were taken first to a special interrogation camp, approximately 150 kilometers northeast of Moscow. Some 50 captured German officers of all branches of the Armed Forces, /sic/ including Luftwaffe officers, were already interned there. There were no non-commissioned officers or men. Generally, two officers were billeted in a single room in barracks. Before these two officers were admitted to the camp, they were kept in a special locked room where they were subjected to interrogation daily from 2-3 hours for about a week. Treatment was good, and the Russian guards were ordered to salute. Food was barely adequate, but the food of the Russian camp officers was no better at that time. Cigarettes were plentiful; even alcoholic beverages were given out in the evening. Treatment was courteous and correct. L. monitoring equipment had been installed in this separate room,

SECRET SECRET

-295-

SECRET SECRET

it could not be discovered by either officer. They were, however, prepared for it and arranged their conversations accordingly.

The interrogating officials were either Russian officers who could speak German very well or Russian interrogation personnel in civilian clothes, whose real mission remained undisclosed. The first "conversations" began with personal questions as to their health, families and home towns. Both officers were permitted to write to their families immediately, on form post cards. The mail was allegedly sent through the Russian Red Cross via Sweden to Germany, but of course this never took place. On the second or third day, both officers were required to write in detail their life histories, which were supplemented on the fourth or fifth day through personal conversations. Pressure to make statements concerning the German situation at the front was not exerted. After about one week, both officers joined the other prisoners.⁷⁶

The report from which the above excerpt was taken indicates the existence of a planned camp-interrogation program, for officers at least, since the installation to which the two German officers were sent was referred to as a "special interrogation camp." Presumably the two officers were co-operative in giving information about their life histories, but the fact that they were guarded in their private conversations indicates that they were anxious not to reveal any information which, as loyal Germans, they felt should be withheld from the Russians. As compared with the program in special interrogation camps later in the war, the program in this camp was very limited indeed, despite the fact that they had to write detailed life histories and were interrogated daily for a week. Later, officers and specialists were kept in special

SECRET SECRET

SECRET SECRET

interrogation camps for many months, were subjected to much longer and more comprehensive interrogations, and were required to write exhaustive treatises on assigned technical subjects. Treatment in such camps was generally better than in the ordinary prisoner-of-war camps, but the interrogators did not hesitate to use coercion if the prisoners did not co-operate in furnishing desired information. During the first phase, Soviet camp interrogators apparently adhered to generally accepted rules of international law in the few interrogations which took place.

The quoted report is representative of other reports on camp interrogations during the first phase of the war. Few German officers were taken prisoner during this period, and it is unlikely that the Soviets could have gained any really valuable strategic intelligence from the limited camp-interrogation program. Much more information is available on interrogation methods instituted by the NKVD when its interrogation teams took over the camp program at the beginning of the second phase of the war. The general pattern of procedure and the methods used by interrogators in conducting the strategic interrogation program remained much the same from that time on; therefore, it will be unnecessary in most instances to refer to the various phases of the war in the discussion of NKVD methods and procedures which follows.

SECRET SECRET

SECRET. SECRET

Second and Subsequent Phases of the War

Prisoners arriving at a Soviet prisoner-of-war camp for the first time were required to fill out elaborate questionnaires, but they were not subjected to oral interrogation, in most cases, for several weeks after their arrival.⁷⁷ This gave the prisoners a chance to become reasonably well-accustomed to camp life. The

interval was used by the interrogation team to study each prisoner's dossier, to make initial classifications, and to prepare plans for the interrogation of the newly arrived prisoners.

All prisoners, no matter how unimportant the individual, were thoroughly interrogated at least once in the camps.⁷⁸ The initial interrogation was so long and exhaustive that several sessions of from two to four hours each were required to complete an investigation in most cases.

NKVD interrogations usually took place at night.⁷⁹ This practice has been remarked upon by practically all repatriated German prisoners and by citizens of satellite countries who at one time or another have been questioned by the NKVD but later escaped to tell their story. Even daytime interrogations were conducted in darkened rooms, simulating night, while bright lights were concentrated on the face of the prisoner being interrogated. Evidently the NKVD deliberately chose night as the best time to conduct interrogations and instructed its personnel accordingly.

SECRET. SECRET

SECRET. SECRET

The practice of conducting interrogations at night must be considered a standard procedure of Soviet interrogation methodology.

Several assumptions may be made on the matter of why the NKVD chose night as the best time to conduct interrogations. Foremost among these would be the psychological factor of fear of the unknown which is stronger at night than in the daytime. Another reason may have been that man's resistance is at its lowest ebb at night and his mind is not as clear, especially when he has been roused from deep slumber and rushed to an interrogation chamber as was the customary procedure. Prisoners were needed as labor, and by interrogating at night a maximum amount of work could still be exacted from the prisoners during the day. The increased fatigue resulting from such a procedure led more quickly to a breakdown of a prisoner's resistance to questioning.

This practice of inducing extreme fatigue as a means of reducing a prisoner's will to resist interrogation was another important aspect of Soviet interrogation methodology. A man who had to work hard every day and then submit to interrogation every night soon became exhausted. Desperate for rest, the prisoner was reduced to a state in which he was morally, mentally, and physically incapable of resisting the insistent demands of the interrogators to give information, to sign a "confession," to act as a stool

SECRET. SECRET

SECRET

SECRET

pigeon, or to bear false witness against a fellow prisoner. If it were necessary to break the prisoner's will quickly, NKVD interrogators, working in shifts, would subject the prisoner to continuous interrogations for several days and nights. In addition to being kept awake and having nothing to eat or drink, the prisoner was usually forced to maintain the same bodily position throughout the ordeal -- standing, leaning against a wall, sitting on the edge of a stool with legs outstretched. After two or three days of such treatment, the strongest prisoner would "confess" to anything in order to get some rest. Usually, a prisoner subjected to such interrogation methods could not remember what had happened after he had recovered from the experience.⁸⁰ This method of interrogation is not unknown to the civil police of other countries. Americans call it the "third degree."

Fatigue was also involved in the Soviet practice of systematically starving a prisoner while keeping him in a solitary confinement cell under debilitating physical conditions for long periods.

The use of fatigue as a method of breaking a prisoner's will took time and persistent effort on the part of Soviet interrogators, but it was often more effective against strong-willed prisoners than the direct application of torture or other more obvious coercive methods.

SECRET

SECRET

-300-

SECRET

SECRET

Before conducting the initial interrogation of a prisoner, an interrogator compared the various reports in the prisoner's dossier and checked them against information already on file in a search for contradictions, inconsistencies, misstatements of fact, or obvious lies. If there were many discrepancies, the prisoner became suspect of concealing important information. Even if no real inconsistencies could be found, the interrogator would select certain statements which could be interpreted as being contradictory. This procedure constituted another characteristic of Soviet interrogation methods -- that of putting a prisoner on the defensive.

A man resents being called a liar, even when he has lied deliberately and purposely. If he has told the truth, he will go to some lengths, especially when he fears punishment, to prove his veracity and thereby often reveals more information. If he has purposely lied, he may tell more lies in an attempt to support his statements and thus further incriminate himself. In both instances he plays into the hands of the interrogator who has achieved precisely the reaction desired.

Although putting the prisoner on the defensive by accusing him of lying may have been a calculated procedure on the part of Soviet interrogators, it must be remembered that in many instances the interrogator sincerely believed that the prisoner was lying

SECRET

SECRET

-301-

SECRET

when, as a matter of fact, the prisoner had been telling the truth. As noted earlier, NKVD interrogators were thoroughly indoctrinated Communists and had been taught to believe that all citizens of capitalistic nations would lie as a matter of principle. Furthermore, many Soviet interrogators, because of a limited and distorted knowledge about conditions in other countries, were incapable of recognizing the truth of certain statements made by prisoners.

Other methods of putting a prisoner on the defensive have been used by Soviet interrogators. Sometimes a prisoner-of-war interrogation would begin with the blunt question, "Why are you fighting against a state of workers and farmers?"⁸¹ When questioning political prisoners in the Soviet Union or the satellite states, NKVD interrogators frequently began an interrogation with, "You know why you have been arrested? No, you don't know? Well, then, why do you suppose?" Six hundred years ago, hooded interrogators of the Inquisition asked the same questions of suspected heretics who had been brought before them.⁸²

The use of questions designed to put an interrogatee on the defensive was a psychologically sound method of interrogation. Most prisoners were nervous, fearful, and confused when summoned to the interrogation chamber. Questions or accusations putting them on the defensive at the beginning of the interview served

SECRET

SECRET

to further their fear and confusion and to rouse an emotion of anger in many of the prisoners. Instead of remaining silent, they would react emotionally rather than rationally to the situation and make a frantic attempt to clear themselves of false charges. This was the response desired by the interrogator.

Camp interrogations were conducted by NKVD officers, most of whom spoke excellent German but on occasion pretended not to know the language and used an interpreter (probably to slow down the pace of the interview and to give the interrogator more time to observe the reactions of the prisoner). Former German prisoners of the Soviets have been almost unanimous in agreeing that NKVD camp interrogators were well trained in the technique and psychology of interrogation, that their knowledge of German military, economic and political matters was surprisingly thorough and complete, and that many of them were conversant with highly specialized scientific and technical subjects.⁸³

In his first interrogation after arriving at a prisoner-of-war camp, the prisoner was immediately confronted with his former statements and told that because of lies and contradictions in his testimony he would suffer severe punishment. This was followed by the statement that he need not fear punishment for his former lies if he would co-operate with the interrogator and talk readily on all matters about which he was to be questioned. Most of these

SECRET

SECRET SECRET

initial interrogations were conducted in a calm, almost benevolent manner.⁸⁴ Fear of the NKVD was so great among prisoners that before the first interrogation took place many of them undoubtedly had decided to answer any and all questions to the best of their ability; near the end of the war most Germans were resigned to defeat and little or no additional intimidation was needed to make a majority of the prisoners talk freely.

Despite the willingness of most prisoners to furnish information, NKVD interrogators seldom permitted an interrogation to consist simply of a straightforward question-and-answer session. Never for long was a prisoner allowed to think that his statements were being accepted uncritically as the whole truth. He was frequently accused of lying, of withholding information, or of concealing his true identity. The interrogator conducted elaborate cross-examinations on seemingly unimportant points or asked the same question several times at widely separated intervals in an attempt to trap the prisoner into making contradictory statements. Every interrogation included questions about a prisoner's personal history which could be remembered only dimly (if at all), while technical interrogations contained questions which even experts could not answer from memory. Thus it was easy to trap a prisoner into making contradictory statements or to ask questions which the prisoner could not possibly answer, and the interrogator could

SECRET SECRET

-304-

SECRET SECRET

manufacture his own opportunities to accuse the prisoner of lying or of malicious obduracy in the withholding of information.

The Soviets were extremely thorough in their collection and collation of minutiae about the German armed forces. Interrogators had order-of-battle information on file which included names of lower unit commanders and noncommissioned officers (with their personal characteristics in many cases) along with complete details of the order of battle, strength, tables of organization, and losses of all German units on the Eastern Front.⁸⁵ The German troops were well aware that the Soviets sought prisoners who had been members of certain units or branches of service (members of SS units, intelligence personnel, secret field police, and similar categories of prisoners) in order to wreak vengeance upon them or to subject them to special investigations. Hence, many prisoners attempted to conceal their identity and claimed to have been assigned to units other than their own. Many such prisoners were exposed by stool pigeons, and most of the rest were exposed during interrogation since the interrogator usually knew more about the unit which a prisoner falsely claimed as his own than did the prisoner. Only occasionally did a prisoner have a "cover story" which stood up under repeated investigations. (For examples of successful cover stories, see Appendix VI, Items 20 and 21.) Prisoners subjected to specialized interrogations on war

SECRET SECRET

-305-

SECRET SECRET

organization of the German Army or on technical subjects ran the same risk of exposure if they lied. For example, a high-ranking German officer who had been a section chief of the Army Personnel Office and who had been taken prisoner was required to work out an organizational chart of the unit to which he had been assigned. After he had completed it, the Soviet interrogator produced a chart for comparison which, fortunately⁸⁶ for the German officer, did not differ from the version submitted.

Methods of interrogation during the initial interviews varied to a certain extent according to the personality and ability of the interrogator. Most interrogators, in turn, varied their approach according to the personality of the prisoner. After an initial interrogation which had not gone satisfactorily from a Soviet point of view, a different interrogator whose personality and approach would be more likely to inspire a satisfactory response from the prisoner was often assigned to conduct the rest of the investigation. It is possible that some initial interviews were conducted in a deliberately brutal manner so that the prisoner could be caught off guard by a different interrogator who would conduct the next interview in a courteous, friendly manner.

(See Appendix VI, Item 32.)

Most of the initial camp interrogations began in an atmosphere of formal and rather patronizing courtesy, but this friendly

SECRET SECRET

SECRET SECRET

atmosphere quickly disappeared, particularly when the prisoner was (or pretended to be) ignorant or if he was caught in a lie. Even if the prisoner was co-operative and knowledgeable, the interrogator would abruptly change his attitude upon receiving some answer which he chose to interpret as being untrue or incomplete. On these occasions, the interrogator would fly into a sudden rage, pound the table, shout threats and abuse, and demand the truth. Sometimes, at this stage, the prisoner was slapped, struck with a fist or a truncheon, or otherwise physically mistreated. (High-ranking German officers and generals were seldom mistreated physically.) After a few minutes of storming rage, the interrogator would suddenly return to his former polite behavior, and the interview would proceed calmly until the next outburst. The prisoner was kept in a constant state of trepidation and mental confusion by such tactics. There is reason to believe that most of these sudden rages were deliberately simulated and that the interrogator, while putting on his "act", was carefully observing the prisoner's reactions to the threats and abuse. In most cases a well-trained, experienced interrogator would be able to make accurate evaluations, both of a prisoner's character and of his information, by adopting such procedures.

The prisoner's initial interrogation in a prisoner-of-war camp was based on a voluminous questionnaire (of about four closely

SECRET SECRET

SECRET SECRET

printed pages) which covered, as had field interrogations, the prisoner's vital statistics, his military service, and his political affiliations. Answers to the questions were carefully checked against reports of previous interrogations and the elaborate questionnaire which the prisoner had filled out upon arrival at the camp. In addition to the foregoing questions, the interrogator made a thorough investigation of the prisoner's entire life including almost comical queries such as, "How many rooms were in your parents' flat when you were born?"⁸⁷ A great many of the questions dealt with economic conditions in Germany, the prisoner's social and economic status in his home community, and his educational and professional background. Answers to these questions determined whether or not the prisoner would be subjected to future investigations because of special professional or technical qualifications.

Regardless of the relative importance of an individual, the Soviets apparently kept a meticulously careful record or dossier on each prisoner to which new information was added as it became available. A prisoner never knew when he might be called in for a special interrogation on some item of information which had acquired new importance. These records were of special value to the Soviets after the fall of 1947 when the search for war criminals was accelerated.

SECRET SECRET

SECRET SECRET

One of the principal objectives of the initial interrogation was to discover prisoners with special technical or tactical backgrounds and experience -- engineers, industrialists, economic experts, scientists, technicians, staff officers, or officers with highly specialized professional qualifications. Such prisoners were subsequently interrogated by Soviet experts and, frequently, were ordered to write scientific treatises on topics upon which they had special knowledge. When ordering a prisoner to write a paper, interrogators often specified the number of pages of manuscript which were to be completed each day (fifteen seems to have been the usual number). Prisoners found that the Soviet officials were satisfied if the right number of pages were delivered on schedule, no matter whether the writing was large or small.⁸⁹

As has been noted earlier in this study, highly qualified specialists were sent to special interrogation camps. Beyond the fact that interrogations in those camps were more intensive and often lasted over a period of several months, methods used by the interrogators were approximately the same as in ordinary prisoner-of-war camps. Living conditions in the special camps, however, were considerably better; the prisoners were not required to perform hard labor; and, as a rule, promises of better treatment and other rewards rather than coercion were used as inducements to reveal information. Apparently, prisoners who were sent to

SECRET SECRET

SECRET SECRET

the special camps had more or less agreed to co-operate before
being transferred.⁹⁰

Seemingly, a majority of the ordinary prisoners talked freely, and after they had been exhausted as sources of needed information, they were not questioned again. Since most of them were line soldiers possessing little or no special information, the average prisoner was of no further use to the Soviet intelligence system after he had furnished details about himself which, combined with similar details from thousands of others, comprised the raw material for the compilation of strategic intelligence. Beyond suffering the rigors of camp life and occasional brutality from guards, and after the initial interrogation, most prisoners were not deliberately and systematically tortured (that is, not in connection with the interrogation program).

Some few prisoners, however, refused to reveal information because of continued loyalty to their country. Others concealed information which was vital to their personal safety (such as their connections with the Nazi party) and were caught in lies. Informers betrayed many prisoners who had lied to their interrogators or concealed their true identity. Information received from outside sources often exposed prisoners who had lied or withheld information. In many cases interrogators construed inability to answer as spiteful obstinacy. Such prisoners were subjected to interrogations which included many forms of physical and mental torture.

SECRET SECRET

SECRET SECRET

An interrogator was limited only by his imagination, and numerous examples of these interrogations have been presented in the case histories in Appendix VI.

A superficial study of NKVD methods of interrogation (or those of the NKGB and Smersh) would seem to indicate that Soviet authorities permitted the interrogators to apply unlimited duress to secure information or confessions from obstinate prisoners. It must be noted, however, that torture methods of interrogation were used only with the permission of responsible higher authority, and care was taken to prevent the death of a prisoner as the direct result of such torture. To cause a prisoner's death in this way seemed to be interpreted (in the deceptive parlance of the Soviets) as a "mistake," and the responsible interrogator was liable to suffer severe punishment as a result. Because of this, medical personnel was often required to be present at interrogations during which physical torture methods were applied. Prison officials and guards were also extremely careful, and for the same reason, prevent a prisoner under investigation from committing suicide. Such precautions were taken particularly when important prisoners were being interrogated in the special NKVD prisons (Lubianka in Moscow or MVD Prison No. 3 in Leningrad, for example). Rarely were guards and interrogators in such institutions spontaneously brutal. Physical torture was ordered, apparently as a last resort,

SECRET SECRET

SECRET SECRET

and was applied in a studied manner designed to produce the desired result with a maximum of physical pain and a minimum of danger to the life of the prisoner.⁹¹ The object was to break the prisoner's will, not to kill him.

The most common form of mental torture to which prisoners were subjected was to threaten harm to the prisoner's near relatives.

This was particularly effective with prisoners whose homes were in areas occupied by the Red Army. Obstinate officers among the prisoners were sometimes threatened with the loss of honor. They were told that press articles and radio broadcasts would announce that they had gone over to the Bolsheviks of their own free will or that they had otherwise committed traitorous acts.⁹²

Extremely severe third degree methods of interrogation, previously described as a combination of physical torture and continuous questioning which produced extreme fatigue, were applied both to prisoners who were obdurate about revealing information and to prisoners whom the Soviets desired to exploit for political reasons. To the latter category of prisoners belonged those who were required to sign confessions of war guilt, those who were required to testify against fellow prisoners or to act as stool pigeons, certain personages who may have been forced to participate in the antifa program, prominent political personages of satellite states, or citizens of satellite states who were pressed into

SECRET SECRET

SECRET SECRET

service as informers or agents. Few if any prisoners, no matter how determined they were, could withhold information when Soviet interrogators used such methods. In most cases, however, less drastic methods were needed to secure information from stubborn prisoners, and extreme methods were used more often for "political" purposes. That these methods were used successfully by the NKVD was demonstrated time and again in the purge trials of the late 1930's when many of the old and trusted Bolshevik leaders made their startling "confessions" at public trials.⁹³

Citizens of the western democracies have often been inclined to depreciate the propaganda value of confessions which, to their way of thinking, have been extracted from the victim so obviously by force. The people behind the iron curtain, however, have practically no sources of information other than the carefully censored, Soviet-directed government news agencies, and such confessions may have far greater propaganda value than most westerners realize. The Soviets' apparent propensity for giving an appearance of democratic legality to their official acts (such as retaining large numbers of prisoners as war criminals) may partially explain the lengths to which they go to secure confessions from those whom they are determined to convict of some crime. Though to the westerner such procedures may seem to be a travesty on democracy, it is possible that the average, thoroughly

SECRET SECRET

SECRET SECRET

indoctrinated Soviet citizen is convinced that truly democratic procedures have been followed.

e. Interrogation Prisons

When third degree methods failed to produce the desired effect, NKVD interrogators resorted to solitary confinement as a means of breaking a prisoner's resistance to interrogation. This procedure involved a combination of confinement in a cell too small and too cold for physical comfort, with continuous light or darkness, complete silence, ceaseless surveillance by brutal guards, long, fatiguing sessions of interrogation, and, in some cases, the use of drugs. When suffering "ordinary" punishment in this fashion, a prisoner received regular prison rations which were barely enough to keep a man alive. When "severe" treatment was ordered, however, the ration was reduced to practically nothing, and the prisoner was systematically starved. (A bowl of watery soup and 300 grams of bread a day seemed to be the usual ration in such cases.)

Despite minor variations of method noted in various camps or prisons and at different times, the general pattern of procedure adopted by the NKVD to break a prisoner by means of solitary confinement was practiced so universally throughout the Soviet Union and its satellite states that it must be considered a characteristic method of Soviet interrogation. ⁹⁴ Before undertaking

SECRET SECRET

SECRET SECRET

a detailed description of this method, the most ruthless of Soviet techniques, it must be emphasized that the procedure was used more often to gain political ends than it was for purposes of gaining information and that only a small number of prisoners of war were subjected to such treatment. The procedure followed in prisoner-of-war camps was essentially the same as that used by the NKVD, the NKGB, and Smerch when dealing with Soviet citizens or citizens of satellite countries who were accused of offering resistance to "the dictatorship of the proletariat" by thought, word, or deed. The treatment to which they were subjected, and which almost always produced the desired confessions, has been aptly described as a "de-personalizing" process. (See Appendix VI, Item 40.)

In prisoner-of-war camps the so-called "punishment bunker" contained a number of solitary confinement cells. These were usually small rooms about two meters square having a polished floor, a tiny barred window near the ceiling, and no furnishings except a chamber pot. No light or heat was provided, even during the winter. At night a wooden bench about a foot wide and five feet long was pushed into the cell to be used as a bed. At most, one blanket was issued, and that only during the coldest part of the winter. In the summer the floor was kept wet to prevent the prisoner from lying down, an act impossible in the winter because

SECRET SECRET

SECRET SECRET

of the extreme cold. It was necessary for the prisoner to exercise continually during the cold season in order to keep from freezing.

95

The smallest type of cell, and one which has been mentioned in a number of reports, was actually a box measuring a meter in each dimension into which the prisoner was crammed in a sitting position. A large electric bulb in the ceiling provided an excess of light and heat, and after ten to twenty hours the prisoner lost consciousness. After being revived with a bucket of icy water, he would be interrogated immediately. (See Appendix VI, Item 22.) A similar type of cell was aptly named the "standing-coffin."

It consisted of a box about a half-meter in depth, a meter wide, and two meters high in which a prisoner could neither sit nor lie down. Sometimes the standing-coffin was a full meter in depth and the prisoner could squat on the floor; at other times the ceiling was so low that the prisoner could at no time stand fully upright.

Solitary cells in some prisons could be alternately heated to a very high temperature and then lowered to a freezing temperature in a short space of time. When subjected first to one and then to another extreme of temperature several times within the space of a few hours, a prisoner was reduced to a state of physical collapse very quickly.

SECRET SECRET

-316-

SECRET SECRET

Numerous other refinements of misery were provided in some cells such as covering the floor with water except for two or three stones on which the prisoner was forced to stand because the freezing temperature did not permit his standing in the water. In many instances the cells were simply makeshift quarters in a damp cellar where insects added to the discomfort of the inmate. Continuous light or continuous darkness caused a prisoner to lose all sense of the passage of time. No latrine facilities were provided in some instances, and the prisoner was forced to live in his own filth. Absolute silence was enforced in most prisons with the exception that prisoners were sometimes permitted to hear the moans or screams of a prisoner under torture -- apparently for the purpose of increasing the atmosphere of terror.

The opposite extreme of solitary confinement was to place several prisoners in a cell so small that there was barely room to stand. This counteracted the tendency of some prisoners to go insane from the loneliness and quiet of the solitary cell. Most prisoners were acutely aware of the informer system that prevailed in the prison camps, and an air of suspicion usually existed in a cell which contained a number of prisoners.

In the special interrogation camps and prisons most prisoners, pending or during the period of their investigation, were put in solitary cells but under conditions which were far more humane

SECRET SECRET

-317-

SECRET SECRET

than those described in the foregoing paragraphs. The less important prisoners were put in common cells. A strict routine of sleeping, eating, cleaning the cells, inspection, and exercise was followed in such prisons; the discipline was severe, and punishment for infractions of discipline was severe. Constant surveillance was maintained by guards through peep-holes, and most of the day the prisoner was forced to sit on the floor where he could be seen through the peep-hole. Lights were burned all night long. Bunks consisted of plain wooden shelves, and prisoners were forced to sleep flat on their backs with their hands above the blankets. If a prisoner changed his position during sleep, a guard would awaken him and force him to resume the required position.⁹⁷ Often the prisoner would be awakened just after he had gone to sleep and rushed quietly to the interrogation chamber. In the common cells psychological tension was heightened by the fact that sometimes a prisoner was taken away by the guard but was not returned, nor could the others learn from the guard what had happened.

The interrogation dungeons were guarded by exceptionally cruel guards, usually of Czech or Polish nationality. One of their primary duties was to prevent any form of communication among the prisoners. This precaution extended to preventing them from seeing each other. When a prisoner was taken from his cell to go to the latrine or to an interrogation, his guard would continuously knock a key against

SECRET SECRET

SECRET SECRET

his belt buckle or give some other signal as a warning for guards to prevent other prisoners from seeing the prisoner who was being moved. Special prisons such as Lubianka in Moscow were said to have a traffic-light system in the corridors so that the movement of a prisoner would not be observed. If a meeting was unavoidable, one prisoner would be forced to stand facing the wall with his face hidden in his arms until the other prisoner had been hurried past.⁹⁸

The guards were often men who had been assigned to the camps for disciplinary reasons and who tried, therefore, to make a favorable impression on their superiors by their cruel treatment of prisoners. At the same time they tried to make up for their disagreeable assignments by stealing the few belongings and the already insufficient rations of the prisoners. Elaborate precautions were taken, however, to prevent the death or suicide of a prisoner being "detained for special investigation," primarily because the guards were held responsible. Not even Russian barbers were permitted to shave the prisoners, but their beards were trimmed with scissors from time to time.

Most prisoners were in poor physical condition when their investigation began, but not even a man in the best of health could stand up for long under the more severe forms of solitary confinement. At best prisoners were fed insufficient food, and in solitary

SECRET SECRET

SECRET SECRET

confinement they were often systematically starved. The psychological effects of fear, loneliness, and mistreatment often threatened their sanity; malnutrition, cold, and foul living conditions frequently caused serious illness. The object of the solitary-confinement "treatment", however, was neither to kill a man nor to make him insane but to drive him to the borderline of both death and insanity where he would become most amenable to the demands of the interrogators. Nurses or doctors visited the prisoners at frequent intervals; and when it was noted that a man was dangerously ill, he was transferred to a hospital, carefully nursed back to health, then returned to the dungeon. If it were noted that a prisoner was going insane, he would be removed from solitary confinement for a time and put in a comparatively comfortable cell with other prisoners. Similar concessions were made in the case of prisoners who attempted suicide by going on a hunger strike. With such prisoners, an interrogator's threat to put them back in solitary confinement often produced the desired result.

The length of time which prisoners were forced to stay in solitary confinement varied more or less according to the arbitrary caprice of the interrogator in charge of an investigation. Prisoners who had refused to give information or who had been accused of obduracy when they could not answer questions were sometimes kept in solitary confinement for weeks before being reinterrogated.

SECRET SECRET

SECRET SECRET

They were then asked the same questions which they could not (or would not) answer before. Usually, obdurate prisoners were by this time willing to talk. After two or three returns to the dungeon, a prisoner who still could not (or would not) supply desired information was sometimes sent back to his base camp and never again interrogated concerning that particular information. The interrogators were apparently satisfied in such cases that the prisoners actually did not possess the desired information. At times, a year or two would pass, and then a prisoner would be suddenly thrown in an interrogation dungeon and subjected to the same procedures and the same questions. The interrogators never told prisoners why they had been suddenly released, and such prisoners were not, as a rule, discriminated against when returned to camp. It was not uncommon, however, for a prisoner suddenly to disappear after serving several terms in the interrogation dungeon. He would be shipped individually to some unknown destination (or, perhaps, executed) and never reappear in the camp again.

Prisoners suffering confinement during investigation never knew when or how often they would be interrogated. In any event, a prisoner lost all sense of time in the continuous light or darkness and the silence of a cell. At times a prisoner would be interrogated every night for weeks; in other cases weeks would elapse between sessions in the interrogation chamber. Physical torture

SECRET SECRET

SECRET SECRET

during the interrogation period was seldom applied in this type of investigation, the interrogators apparently being satisfied that solitary confinement with its debilitating effect on both body and mind would bring about the desired results. The initial interrogations were often conducted in a friendly manner but grew progressively more severe as the prisoner remained obdurate. Time and again the prisoner would be forced to sit in a chair with bright lights focused on his face while the interrogator monotonously and maddeningly repeated the same questions, accusations, or demands. The sessions were usually conducted in a manner which roused the prisoner's emotions and caused mental confusion. The rapid-fire questions were mingled with shouted curses, threats, and personal abuse. Witnesses were brought in to identify the prisoner or to present conflicting testimony, and the prisoner was confronted with documentary evidence of his "guilt." All sorts of promises to improve the prisoner's living conditions were made to induce the prisoner to talk -- along with threats that the conditions would further deteriorate if he did not comply with demands. A starving prisoner was sometimes questioned by an interrogator across a table upon which was laid an appetizing meal and told that he could eat if he would give information or "confess." Sometimes a prisoner was given salty food but nothing to drink before an interview conducted by an interrogator who taunted the parched prisoner

SECRET SECRET

SECRET SECRET

by drinking long draughts of water or beer between questions. Occasionally an investigation was brought to a close by the technique of using shifts of interrogators over a period of many hours until the prisoner reached a state of utter exhaustion.

If the prisoner had been withholding information and finally confessed, it often happened that he did not achieve the relief from torture he had hoped for. Now that the interrogator was sure the prisoner had been withholding information, the latter was subjected to a continued program of punishment and interrogation on the theory that he was still withholding desired information.

The technique of accepting a "confession" varied according to the situation. Sometimes the confession was written in Russian, and the prisoner did not know for sure what he was signing. Even if it was in his own language, the prisoner was seldom permitted to read it completely, and, if he was permitted to read it, he was not allowed to change any of the statements before signing. At other times, when the prisoner had finally agreed to confess, he was required to copy a prepared confession completely in his own handwriting, or else he and his interrogator worked out a confession together, sentence by sentence -- a process that often required days of effort and wrangling between the prisoner and interrogator as to the content of the confession. In the end, however, the document either met the Soviet specifications completely or it was

SECRET SECRET

SECRET SECRET

not accepted.

Once a prisoner had completed the required confession and signed it, his Soviet jailors often completely reversed their conduct. The prisoner was treated as a jolly good fellow by his interrogators who joined him in a feast. He was put in a comfortable cell, given plenty to eat, drink, and smoke, and allowed to mingle with other prisoners. High-ranking prisoners were often transferred to pleasant country villas in comparatively luxurious surroundings. In some cases, however, the prisoner was sent back to solitary confinement to await trial and execution. The latter type of prisoner was in rare cases given extensive coaching as to how he would act and what he would say at a public trial. In the case of such prisoners who have been brought to trial for political purposes, it may be said that three phases of "interrogation" took place before the trial: first, the prisoner was induced to "confess;" second, he was made to elaborate on his confession; third, he was taught how to testify against himself and others, to show remorse, and even to request punishment for his traitorous conduct or "errors."

f. The Use of Drugs in Interrogations

In a number of reports regarding the investigations of important political prisoners reference has been made to the Soviet use of drugs to induce a state of narcosis in a prisoner. While

SECRET SECRET

SECRET SECRET

under the influence of these drugs, it is alleged that the prisoner will confess to anything or otherwise comply with the demands of his interrogators and prosecutors.

The use of "truth-serums," lie-detectors, and other artificial means of probing the mind of an individual has long been a popular subject with newspaper and magazine readers in the western world. Consequently, this aspect of Soviet interrogation methodology has been the subject of considerable comment and speculation outside the Soviet Union. Despite all this comment, very little, if any, information of a reliable nature is available on the subject. Most former prisoners of war of the Soviets, when questioned on the matter, say that they have heard of the Soviet use of "truth" drugs, but none, so far, has admitted to a first-hand knowledge of their use. This in itself would indicate that drugs were not used by Soviet interrogators on ordinary prisoners of war as a method of inducing them to reveal information. Sufficient evidence is available, however, to permit the assumption that the Soviets have used drugs as a means of inducing certain important political prisoners to confess to various crimes against the Soviet Union and to bear witness against fellow "conspirators." In practically all such cases, a political purpose was served by gaining the confessions or accusations. Trusted and influential leaders (who probably challenged the power of their superiors) were made to confess

SECRET SECRET

SECRET SECRET

their sins publicly and thus bring the blame for their punishment upon themselves rather than upon their accusers.

It would seem that the Soviets are still in the process of experimenting with various drugs or combinations of drugs which will cause a prisoner to lose his own willpower and become completely submissive to the will of his captors. Apparently, they have not yet found a completely satisfactory course of treatment to accomplish this purpose. While they have succeeded in securing compliance from some individuals who had previously been intractable, they have done it at the obvious expense of the subject's mind. When the prisoner has finally been put before the public to make statements or accusations desired by the Soviet authorities, he has not always reacted as desired, or else he was obviously under the influence of drugs (or abject terror) and the parrotings of statements required by his prosecutors have failed to convince impartial observers that he was making them of his own free will.¹⁰¹

There is no evidence that the Soviets have discovered a drug which will cause a prisoner to willingly reveal information which he would otherwise withhold from his interrogators. What they seem to have been able to do is, first, to retard certain mental processes of the subject by artificially inducing amnesia and a breakdown of will-power, and, second, to create a new personality and "memory" by a systematic program of suggestion (or, possibly,

SECRET SECRET

SECRET SECRET

by a form of hypnosis). The problem has been to destroy only enough of a man's mind to make him lose his original personality and then to build on the remains of that mind a new personality with changed patterns of moral behavior and a new "memory."

Various reports have mentioned chloral hydrate, scopolamine, mecaline (or mescal), and actedron (or aktedron) as drugs which have been used by Soviet interrogators.¹⁰²

Chloral hydrate is a well-known drug and is used as a sedative and soporific by physicians. It is considered one of the cheapest and most effective of hypnotics. Given in large doses it can produce complete anesthesia, but this is dangerous because it may cause respiratory paralysis and death. A dose of ten grams or more is fatal to most adults. Liquid chloral in combination with alcohol is popularly known in America as a "Mickoy Finn" or knock-out drops. According to the source reporting the use of this drug by the Soviets, it has been "used for breaking down the will-power."¹⁰³

Continued use of chloral hydrate may lead to habituation and a slight degree of tolerance, but addicts often suffer sudden death from its use. A person addicted to chloral hydrate bears many clinical resemblances to a chronic alcoholic.¹⁰⁴ It is evident, therefore, that by forcing a person to become a chloral hydrate addict a break-down of will-power could be achieved, and by careful experimentation the Soviets may have discovered a course of treatment

SECRET SECRET

SECRET SECRET

with this drug which will cause an obdurate prisoner to become tractable when subjected to interrogation.

Actedron is a drug unknown to American medical science. It may be a trade name of a drug which, as is the case with many European pharmaceutical products, gives no indication of its chemical formula.¹⁰⁵ According to reports, however, actedron is a narcotic which, when given orally, produces excitement, enlivens the subject physically, makes it impossible for him to sleep, and, in general, causes him to become nervous and restless. In the case of Cardinal Mindszenty, actedron was administered (according to the report) by means of dissolving it in coffee which was given to the Cardinal during a long interrogation.¹⁰⁶

The doses of actedron have allegedly been given during the course of long interrogations which were designed to cause physical exhaustion. According to one source, the doses were followed by the administration of an ice-water enema which thoroughly chilled the prisoner, caused diarrhea, and further exhausted the subject physically.¹⁰⁷ This was followed by injections of scopolamine which were purported to cause an almost complete loss of memory (amnesia).

Scopolamine is a well-known drug, being an ingredient of the anesthesia popularly called "twilight sleep," and is usually administered in combination with doses of morphine. The drug also is known to produce amnesia, but only in the sense that the patient

SECRET SECRET

SECRET SECRET

has no memory of pain suffered or of what took place (an operation, for instance) while under its influence. It has tranquilizing properties and relieves a patient's emotional disturbances, but in the presence of pain it may cause delirium unless morphine is also used.¹⁰⁸ Whether or not repeated injections of scopolamine will eventually cause complete amnesia is not known to western science.

No mention of the use of scopolamine has been made in connection with the interrogation of Cardinal Mindszenty, but in that case as well as others it seems that mescaline was the principal drug used to "split" the personality of the prisoner (that is, to induce an artificial psychotic condition resembling schizophrenia). This drug, a product of a cactus plant, has been used for centuries in the religious ceremonies of certain tribes of Indians of the American southwest for the psychic effects and hallucinations which it produces.¹⁰⁹ According to an authority on the subject of "mescaline psychosis," this drug produces an intoxication which results in true schizophrenia, that is, if the term is used in the sense of "split mind," for it results in a fragmentation or a breaking up of the personality. In other words, the symptoms of mescaline intoxication are exactly the same as those noted when a patient suffers with the psychosis known as schizophrenia.¹¹⁰

Apparently, the Soviets have used mescaline for their so-called

SECRET SECRET

SECRET SECRET

"de-personalization" of a prisoner under investigation. The drug (in combination with the accompanying treatment) has caused a prisoner's nervous system to become partially inoperative. At a certain point in the "treatment" a prisoner would finally consent to make a confession, and he would be kept in a state of mental exhaustion through the use of drugs until complete control of his mind had been achieved. With the mind and the personality thus disintegrated, a skilled psychiatrist would set to work and, by a combination of hypnotism, auto-suggestion, and the continued use of drugs, remould the personality of the prisoner to an appreciable extent and induce him to make the desired statements before the public.

It must be emphasized that the foregoing description of the Soviet use of narcosis as a method of interrogation is based entirely upon unauthenticated reports and consist of little more than conjectures. It is safe to assume, however, that the Soviets have not yet discovered a "truth serum" as such. Narcosis has not actually been used for purposes of securing information (although that may have been one of the purposes of Soviet experimentation in this direction) but rather for purposes of political propaganda: the prominent political personage is made to recant before the masses.

So far as is known, no experiments have been made in America

SECRET SECRET

SECRET SECRET

with scopolamine, mescaline, or chloral hydrate for the purposes which the Soviets are purported to have used these drugs. United States Army psychiatrists have made limited experiments in the use of narcosis to attempt the diagnosis or cure of various types of combat neuroses. These experiments, it is ascertained, have shown that a person under narcosis will still not reveal the things in his mind which, if known to others, will be inimical to his welfare.¹¹¹ This would indicate that a prisoner of war could not ordinarily be induced to reveal information while under the influence of drugs or hypnosis if by doing so he would offend his moral code or further endanger his personal welfare. The Soviets apparently have accomplished their limited purpose by using drugs which have literally destroyed the mind of the victim. Western ethics have not permitted such drastic programs of experimentation with human beings.

As has been noted, the Soviets have attempted to use narcosis only in the interrogations of certain important political prisoners, and there is no evidence that prisoners of war, even the important ones, have been subjected to such treatment. The technique of using drugs obviously requires the services of highly specialized medical and psychiatric personnel and the process consumes a considerable period of time. With less important prisoners, the Soviets have resorted to the use of brutality and exhaustion to achieve results similar to those achieved by the use of drugs.

SECRET SECRET

SECRET SECRET

In any event, the use of drugs has apparently been confined to cases in which the Soviets desired to secure "confessions" to crimes which the prisoner had not committed or to force the prisoner to make statements of political value to the Soviet regime rather than to secure useful information; that is, such interrogations have had a political rather than an intelligence objective, and only by stretching the meaning of the word can such procedures be called "interrogations."

g. Interrogation of War Criminals

Most of the German prisoners who were interrogated during the fifth stage (fall of 1947 to 1950) were subjected to the political rather than the intelligence type of interrogation. The main political objective of this program was to weaken resistance to communism in Germany by preventing the repatriation of German prisoners who were potential leaders of resistance to Soviet penetration or who were capable of giving special assistance to the revival of Germany as an anti-Soviet military power. Other objectives were the retention of a large number of slave laborers, including scientists and technicians needed in Soviet science and industry, and the punishment of Germans who had committed war crimes against the Red Army or the civilian population of the Soviet Union. The program was directed largely against the German officer class and affected about ten percent of the officers who

SECRET SECRET

SECRET SECRET

had not been repatriated as of the beginning of the fifth stage. Large numbers of enlisted men were affected, however, since they were needed as slave laborers. ¹¹² It must be emphasized that the practice of trying and convicting German prisoners as war criminals had been taking place throughout the war; the fifth phase was merely characterized by the increased pace of this program. The Russians wished to hold certain prisoners indefinitely and yet be able to claim that all prisoners of war had been repatriated as of the end of 1948 per the Allied agreement, for under international law a convicted war criminal loses his status as a prisoner of war.

In order to maintain a semblance of legality in the trying of war criminals, the Soviets went through a painstaking legal procedure of collecting evidence, charging prisoners with violations of certain laws, and conducting trials in courts. The term "war crime," however, was defined so loosely (particularly during the fifth phase) that almost any German prisoner whom the Soviets desired to retain could be convicted of some crime. The charges against prisoners were either based on a directive of the Supreme Soviet promulgated in 1943 or the prisoners were charged with violations of certain parts of the Soviet criminal code. Russian officers, when questioned by prisoners on this matter, maintained that during the Yalta Conference the Allies had ceded the right to the Soviet Union to try German prisoners for war crimes under

SECRET SECRET

SECRET SECRET

¹¹³
Soviet law. Actually, the Yalta Agreement contained no clauses concerning war criminals, but the Moscow Declaration of 1943 did contain an appropriate clause:

At the time of the granting of any armistice to any government which may be set up in Germany, those German officers and men and members of the Nazi party who have been responsible for, or who have taken a consenting part in the above atrocities, massacres, and executions, will be sent back to the countries in which their abominable deeds were done in order that they may be judged and punished according to the laws of these liberated countries and of the free governments which will be created therein.¹¹⁴

From the standpoint of Allied agreements, therefore, it would seem that the Soviets were within their rights when they tried German prisoners under Soviet law. What can be questioned was the absurdity of many of the charges, the fact that many prisoners were forced to confess to crimes which they did not commit, and that other prisoners were forced to bear false witness in the courts.

The Directive of the Supreme Soviet upon which many charges against prisoners was based was promulgated on 19 April 1943. This provided for the punishment (5 to 25 years in labor or correction camps) of members of the German armed forces who were guilty of reprisals, mistreatment, pillaging, evacuations, and local requisitioning and who had applied duress and committed other atrocities. This directive was used as the basis for charges against all former commandants of rear areas and their subordinates,

SECRET SECRET

SECRET SECRET

including those who had anything to do with Soviet prisoners of war. All members of security units (Sicherungsverbaende) who had guarded rear areas were accused of war crimes because they had fought against partisans. The destruction of villages and the occasional killings of civilians incidental to partisan warfare seems to have furnished the Russians with an excuse to consider all former members of security divisions (even chaplains) guilty of war crimes. An enlisted man of a police division who repaired shoes, probably as a sideline, was accused of a war crime for thus having "assured the battle-worthiness of his division."¹¹⁵ Supply and administration officers were convicted under this directive unless they could prove that they had not made use of captured Soviet supplies and building materials, and individuals were convicted for having appropriated a chicken from a Russian barnyard or a pair of felt boots from a deserted house. The list could be extended almost indefinitely.

When not charged with violating the 1943 directive, accused German prisoners were usually charged with violating Paragraphs 17 or 58 of the Soviet Criminal Code. Both of these paragraphs appeared in the section of the code entitled "Counterrevolution, Subversive Activities."

According to Paragraph 17, punishment could be imposed upon persons guilty of participating in or having knowledge of criminal

SECRET SECRET

*War
Crimes*

SECRET SECRET

action or upon persons who had belonged to organizations in which criminal actions took place even though such persons did not have a part in the crime. This paragraph provided a "catch-all" clause under which it was possible to punish anyone who had given aid to others who had committed punishable acts or who had belonged to any of the German military units listed by the Soviets as guilty of war crimes.

Paragraph 58 of the criminal code consisted of several subparagraphs of which only two were used in prosecuting German prisoners. Sub-paragraph 4 provided for the punishment of persons who supported an anti-Soviet system and by doing so inflicted damage on the Soviet Union. Sub-paragraph 6 applied to those who collected information in Soviet territory and disseminated or evaluated such information to the detriment of the Soviet Union. Obviously, these sections of the code (as well as Paragraph 17) were designed to apply to Soviet citizens guilty of counter-revolutionary activities within the Soviet Union. The Soviets stretched the meaning and intention of these laws in order to apply them to German military personnel. Sub-paragraph 4, for instance, was applied to the entire military judiciary and 6 was applied to all German intelligence personnel.

The Soviet theory of collective guilt expressed in the laws cited above resulted, according to one German writer, in two waves

SECRET SECRET

SECRET SECRET

of arrest in the prison camps during the fifth phase. The first wave affected local and regional military government officers and commandants of prisoner-of-war camps, members of the military judiciary and of the local defense units (Landesschuetzen), intelligence personnel (including even clerks and drivers), many administrative and fiscal officials (Intendanten), and several veterinary officers. The second wave resulted in the arrest of all members of the Wehrmacht who during the war had served in any capacity in Polish territory, the remainder of the administrative and fiscal officials as well as members of the judiciary (even if the latter had never functioned in this capacity in the USSR), all heads of the military railroad administration and all railroad engineer troops, all members of naval units which had been committed in Kurland (they were charged with "evacuation of the civilian population"), the remainder of the prisoners who had formerly belonged to security units, the bulk of the general staff officers, and many unit commanders (during the last wave, no colonel who had been a regimental commander was released). In addition, there were collective convictions of entire organizations, such as the SS, SD, ¹¹⁶OT (Organisation Todt), police, and others. It was not necessary for the accused prisoner to have been a member of an organization at the time alleged punishable acts had been committed, nor was it necessary that he have personal knowledge of those acts, in

SECRET SECRET

SECRET SECRET

order to become liable for punishment. Thus, a German major who had never left Germany during the war was charged with "participation in atrocities," and a staff operations officer was convicted because as the superior of the staff intelligence officer he had shared responsibility for the latter's actions, collected information on the morale of the civilian population, and employed civilians in the construction of positions.

German prisoners of war affected by the Soviet program of prosecuting so-called war criminals during 1948 and 1949 fell into approximately nineteen categories according to an appeal made to the Federate Government at Bonn by repatriated German officers who had been held in Camp 7270 at Borovichi, USSR. These categories are listed below with, in some instances, the reasons for their prosecution and the law under which they were charged given in parentheses.

1. All members of the judiciary, whether or not they had been in Russia during hostilities. (Par. 58/4. They had "strengthened and advanced the military potential of an anti-Soviet power through their application of criminal law.")¹¹⁹
2. All General Staff officers. (Par. 17 and 58/4).
3. All field grade officers of General Headquarters and of engineer and railway engineer units.
4. All commanding officers of security units.
5. Officers of local defense battalions (Landesschuetzen). (Directive of the Supreme Soviet, April 1943).

SECRET SECRET

SECRET SECRET

6. All members of agencies which had anything to do with (Soviet) prisoners, civilians or partisans. The former included all Organisation Todt leaders, army construction officials in so far as they had been actively engaged in construction projects, officer specialists in agriculture and forestry, and officials of the army labor office. (1943 Directive).

7. Naval staff officers formerly stationed at Libau and Windau. (They had evacuated Soviet civilians and property, the "Soviet civilians" actually being Baltic civilians fleeing from the Russians.)

8. Airbase commandants and their superiors. (They had blown up airfields.)

9. Administrative and fiscal officials (Intendanten) with an academic background. (They had executed local requisitions.)

10. Commanding officers of supply units. (They also had executed local requisitions.)

11. All members of local and regional military government headquarters, transportation and railway transportation officers, and members of Wehrmacht security patrols. (1943 Directive).

12. All regimental commanders. (Par. 17).

13. Practically all officers holding the rank of colonel. (Par. 17).

14. SS and police officers of field grade whether or not they had been in Russia. (Par. 58/4).

15. All other SS and police officers if they had been in Russia. (Par. 58/4).

16. All commissioned and enlisted intelligence personnel regardless of their function, even cooks, clerks, and drivers. Since divisional intelligence performs the additional function of special service, furnishing the troops with reading material, vocational training courses, legal advice, etc., all commissioned and enlisted personnel which had solely performed special service functions were also placed under arrest. (Par. 58/4 and 58/6).

SECRET SECRET

SECRET SECRET

17. All commissioned and enlisted personnel, including doctors, who had served in Russian prisoner-of-war camps. (Par. 58/4 and 58/6).

18. All field-grade officers of specific German divisions. (In Camp 7270, field grade officers of the 24th and 290th Infantry Divisions and of the 300th Special Purpose Division were particularly sought after.)

19. All members of the German military police.

Although the fifth stage began in the autumn of 1947 and was marked by improved living conditions and a stepping-up of the propaganda program in the camps, it was not until mid-1948 (at the time of the Berlin "air-lift") that large-scale interrogations began in connection with the Soviet program of convicting wholesale lots of prisoners as war criminals in order to prevent their repatriation. This program reached the height of its activity in the latter half of 1949. Beginning about the middle of 1949, special commissions (apparently sent from MVD headquarters in Moscow) began to arrive at the camps with lists of prisoners who were alleged to have been members of units accused of atrocities on Soviet territory.

The theme of the interrogations centered around war crimes, cruelties, measures against partisans, the handling of Soviet prisoners, the treatment of the civil population, and local requisitioning (Entnahme aus dem Lande). According to former prisoners held in Camp 7270 at Borovichi, interrogations there

SECRET SECRET

SECRET SECRET

(which began in June 1949) generally consisted of a cross-examination of the prisoner on former statements made by him concerning his occupation, his social status, and his views on politics and the military, followed by queries on one or more of the following subjects:

1. Atrocities or orders leading to atrocities.
2. Evacuation of the civilian population and the clearing of houses for the billeting of German troops.
3. The local requisitioning and appropriation of food-stuffs, fodder, and building materials.
4. The employment of Soviet civilians and prisoners of war.
5. Intelligence activities, including interpreting (interrogation) and special service functions, radio and telephone monitoring, and strategic reconnaissance.
6. Application of criminal law against auxiliaries, prisoners, and civilians by the judiciary.
7. Firing on localities [villages].
8. Fighting against partisans.
9. The prisoner's (former) residence abroad, especially in countries adjacent to the Soviet Union.¹²¹

Interrogation reports had been carefully screened, and prisoners who had previously admitted to having been members of certain units or to having participated in certain battles were considered automatically guilty of war crimes. Prisoners brought in for questioning often could not divine the purpose of the

SECRET SECRET

SECRET SECRET

interrogation. The prisoner was purposely misled by questions which covered a wide field, and he was often trapped into making some statement which could be used against himself or others in a subsequent trial. Sometimes as much as two months would lapse between such interrogations while informers kept close surveillance over the prisoner. At the next interrogation he would be confronted with things he had said or done in an attempt to trap him into an admission of guilt to some war crime.

The Soviets were meticulous in the matter of securing what they considered sufficient evidence to convict a prisoner of a war crime. Sufficient evidence, apparently, consisted either of an admission of guilt on the part of the prisoner (a confession) or testimony to the guilt of the prisoner by at least two witnesses.

In some few instances, administrative officials who consistently denied any participation in the making of requisitions against the Russian civilian population were not sentenced and charges against them were dropped. The same thing happened when an engineer could prove that materials he had used in construction had been brought from Germany. The clearing-up of early mistakes caused by incompetent interrogators sometimes worked in the prisoner's favor. Furthermore, a firm stand in the face of an interrogator, especially if the latter's case was based on sketchy evidence, often saved the day for certain prisoners. If the Soviets were determined

SECRET SECRET

SECRET SECRET

to prevent the repatriation of a specific prisoner, however, and the original charges could not be proved, they simply trumped up other charges and either forced the prisoner to confess to the alleged crimes or forced other prisoners to bear witness against him.

The methods of interrogation employed by the special MVD interrogators who carried out these pre-trial "investigations" differed little from the methods described earlier in this study except, of course, for the fact that there was a predominance of the "political" type of interrogation. The interrogators were determined to get the desired results and were expert in the use of third degree methods if the prisoner was obdurate. Duress was not necessary in most cases since the automatic arrest categories and the fabricated testimony of witnesses accounted for most of the convictions. During this period, when many prisoners desired above all else to return home, threats of further retention or promises of early repatriation were particularly effective. Sometimes a prisoner who had refused (or who was unable) to give desired information would be put on a repatriation train and started for home, but he would be picked up by police at the first stop, sent back to camp, and reinterrogated. Solitary confinement and the "fatigue" methods were used if necessary. Care was taken to prevent the death of a prisoner, but he was subjected to terror,

SECRET SECRET

SECRET SECRET

gain, or exhaustion until he finally made the desired confession. Usually an obdurate prisoner was reduced to a stupor or a state of utter exhaustion by the time he signed a confession, and he rarely knew its contents. In any event, the confession was usually written in Russian, and all he knew was what his interrogator chose to tell him. In this matter, practice apparently did not conform with regulations, and a few prisoners who firmly insisted upon a translation of their confessions were able to secure them.¹²⁶

The arrests of accused war criminals and the subsequent trials were conducted in a formal manner, the prisoner being indicted before an official, imprisoned and given a copy of the charge sheet, tried a few days later before a tribunal of three officers, invariably found guilty, and sentenced to a number of years of hard labor in a Soviet penal camp. The right of appeal was granted to convicted prisoners, but seldom if ever was a judgment reversed.¹²⁷ The charge upon which a conviction was based often consisted simply of ". . . because he (the defendant) has belonged to the _____ Division, which committed war crimes."¹²⁸

D. Summary

In the early part of the war between the Soviet Union and Germany, the Red Army's prisoner interrogation program was poorly organized and ineffective. Few prisoners were taken by the Soviets,

SECRET SECRET

SECRET SECRET

and many of those were killed by their captors before they could be interrogated. Soviet intelligence personnel was poorly trained and inexperienced, and practically no interrogations took place in the prisoner-of-war camps.

The need for prisoner information and for large numbers of prisoners as workers led to a reorganization of the interrogation program, the rapid training of needed personnel, and an enforcement of regulations in regard to the sparing of prisoners' lives. By 1943, the procedure for interrogating prisoners had been developed into an excellent system for the gathering of information. (See Figure 1.) Bureaucratic control of the procedure resulted in the administrative delays and inertia characteristic of a huge bureaucracy, but the extreme centralization of the program (in the hands of the NKVD) resulted in the advantages overbalancing the faults.

During hostilities, the interrogation of prisoners took place both in the field and in the prisoner-of-war camps. The Soviets retained millions of prisoners for several years after the war, and the interrogation program was continued in the camps for purposes of gaining several types of information: (1) information about the armed forces and the economies of potential enemies of the Soviet Union, (2) scientific and technical information needed by Soviet industry, and (3) information needed to convict large

SECRET SECRET

SECRET SECRET

numbers of war criminals whom the Soviets wished to retain for political and economic reasons.

The field interrogation program was conducted by at least four agencies: (1) Military intelligence, (2) GUKR NKO (Smersh), (3) the Political Directorate, and (4) the NKVD. Each agency conducted its own program and distributed information through separate channels. The latter agency, however, confined most of its interrogation program to the prisoner-of-war camps.

Military intelligence was strictly limited to the gathering of combat information of immediate tactical value to the collecting unit. On the basis of such information the Main Intelligence Administration (GRU) of the Red Army could, of course, formulate a limited amount of strategic intelligence about enemy armed forces and intentions. The other three agencies, while ostensibly separate, were closely related by virtue of the fact that they were direct agencies of the Communist party and were permitted to gather strategic information. Soviet leaders were determined to restrict the knowledge of true information about other countries (that is, strategic intelligence) to as few individuals as possible and only to the most trusted supporters of the regime.

GUKR NKO (Smersh) was the counterintelligence agency of the Red Army and interrogated spies, saboteurs, Soviet deserters, enemy intelligence, counterintelligence, field police personnel, enemy

SECRET

SECRET

SECRET SECRET

"political" troops (members of militant Nazi party organizations such as the SS and SA), prisoners suspected of war crimes, and similar categories of prisoners. Military intelligence agencies were required to turn such personnel over to Smersh as soon as they were screened from among the prisoners.

The Political Directorate of the Red Army conducted interrogations for purposes of gaining knowledge about each prisoner's social, economic, political, religious, and educational background and information about the status of enemy morale which would be of value to the Soviet psychological warfare program.

In the field, the NKVD conducted interrogations only at army level where all prisoners were turned over to that organization. Reports of all interrogations conducted by other agencies in the field were turned over to the NKVD which kept an elaborate dossier on each prisoner. All prisoner-of-war camps were under the direct supervision and control of the NKVD, and this agency had complete charge of the strategic interrogation program in the camps as well as the prosecution of war criminals. This organization was, therefore, by far the most important agency participating in the prisoner-of-war interrogation program and was the final authority responsible for the collection, collation, and evaluation of prisoner information on the strategic level. Numerous other agencies, however, participated in the camp interrogation program including the NKGB,

SECRET

SECRET

SECRET SECRET

which was responsible for state security, and various industrial administrations, which were interested in gaining scientific information and in securing skilled labor for Soviet industry. The Soviet judicial system had a part in the prosecution of war criminals.

Military intelligence was hampered in its interrogation program by the excessively rapid evacuation of prisoners and, during the early part of the war at least, by poorly trained interrogation personnel. Questions were asked according to standardized forms provided at each echelon of command from battalion to army. In addition, provisions were made for field commanders to obtain tactical information of direct concern to their commands. The "main" interrogation usually took place at division. Corps was often by-passed in the evacuation process.

Copies of the interrogation reports accompanied each prisoner on his way to the rear and to the camps. Interrogators at the higher echelons studied these reports before conducting an interrogation. If discrepancies occurred in the reports, the prisoner was suspected of lying and was, consequently, subjected to more exhaustive interrogations than he would have been otherwise. As the war progressed, accurate order-of-battle information became available to lower echelons of the field forces, and interrogators made extensive use of such information to verify and evaluate prisoner-of-war statements.

SECRET SECRET

SECRET SECRET

Important prisoners were evacuated as quickly as possible from the front lines to higher echelons for questioning. Technicians, scientists, and other specialists among the prisoners were questioned by appropriate specialists from the various arms and services of the Red Army. If unusually large numbers of prisoners were taken, only the more important and well-informed prisoners were interrogated; the others were required to furnish a minimum of personal data and were interrogated more thoroughly after arriving at a prisoner-of-war camp.

The Soviets did not pretend to abide by any international conventions or customs in respect to the treatment of prisoners, and Soviet interrogators frequently applied unlimited duress in attempts to make obdurate prisoners reveal information. Military intelligence interrogators, however, used coercive methods much less than did the interrogators of other Soviet intelligence agencies. Most German prisoners were apparently willing to reveal information required by military intelligence, and the evacuation process was so rapid that military intelligence interrogators in the lower echelons could not apply excessive maltreatment to obdurate prisoners when others were available who would reveal the needed information. Each interrogator, of course, had his own method of approach which varied to a certain extent according to the personality of the prisoner. In marked contrast to the

SECRET SECRET

SECRET SECRET

which was responsible for state security, and various industrial administrations, which were interested in gaining scientific information and in securing skilled labor for Soviet industry. The Soviet judicial system had a part in the prosecution of war criminals.

Military intelligence was hampered in its interrogation program by the excessively rapid evacuation of prisoners and, during the early part of the war at least, by poorly trained interrogation personnel. Questions were asked according to standardized forms provided at each echelon of command from battalion to army. In addition, provisions were made for field commanders to obtain tactical information of direct concern to their commands. The "main" interrogation usually took place at division. Corps was often by-passed in the evacuation process.

Copies of the interrogation reports accompanied each prisoner on his way to the rear and to the camps. Interrogators at the higher echelons studied these reports before conducting an interrogation. If discrepancies occurred in the reports, the prisoner was suspected of lying and was, consequently, subjected to more exhaustive interrogations than he would have been otherwise. As the war progressed, accurate order-of-battle information became available to lower echelons of the field forces, and interrogators made extensive use of such information to verify and evaluate prisoner-of-war statements.

SECRET SECRET

SECRET SECRET

Important prisoners were evacuated as quickly as possible from the front lines to higher echelons for questioning. Technicians, scientists, and other specialists among the prisoners were questioned by appropriate specialists from the various arms and services of the Red Army. If unusually large numbers of prisoners were taken, only the more important and well-informed prisoners were interrogated; the others were required to furnish a minimum of personal data and were interrogated more thoroughly after arriving at a prisoner-of-war camp.

The Soviets did not pretend to abide by any international conventions or customs in respect to the treatment of prisoners, and Soviet interrogators frequently applied unlimited duress in attempts to make obdurate prisoners reveal information. Military intelligence interrogators, however, used coercive methods much less than did the interrogators of other Soviet intelligence agencies. Most German prisoners were apparently willing to reveal information required by military intelligence, and the evacuation process was so rapid that military intelligence interrogators in the lower echelons could not apply excessive maltreatment to obdurate prisoners when others were available who would reveal the needed information. Each interrogator, of course, had his own method of approach which varied to a certain extent according to the personality of the prisoner. In marked contrast to the

SECRET SECRET

SECRET SECRET

inexperienced bungling and cruel methods of interrogators early in the war, the experienced and well-trained interrogators assigned to the higher echelons (division and up) at the end of the war were clever and skillful in their jobs. They often accorded traditional military courtesies to prisoners and usually secured the desired information by means of using a proper psychological approach and cross-examination rather than by use of physical coercion. Kindness, intimidation; promises, threats; offers of food and tobacco, slaps or blows with the fist, cross-examination, dissimulation -- these were the methods generally employed by military intelligence interrogators.

A basic method of interrogation used by all Soviet interrogators was that of putting a prisoner on the defensive by accusing him of lying and by threatening punishment; hence, the careful search in the records of each prisoner for contradictions or discrepancies in his testimony. Soviet interrogation personnel seemed to believe, as a part of their political creed, that all prisoners lied as a matter of principle because they were members of a "capitalistic" society.

Despite the fact that military intelligence was primarily interested in tactical information, interrogations in the field often took a strong political bent. Interrogators probed the prisoners' political beliefs in attempts to discover Nazi fanatics

SECRET SECRET

SECRET SECRET

or political Soviet sympathizers; they criticized the enemy system of government and lectured on the superiority of the Soviet way of life.

Smersh interrogation methods were harsh, and torture methods were often used to make obdurate prisoners reveal information. Many prisoners questioned by Smersh were executed after they had revealed the desired information. Some of the captured spies were recruited as "turned-around" agents against their own military forces. Little is known about the eventual fate of most prisoners interrogated by Smersh since they were evacuated through separate channels to special punishment camps, and few if any of them have been repatriated.

Political Directorate interrogators were harsh if necessary, but their methods approximated those used by military intelligence interrogators. Their interrogations had an especially strong political flavor, and they made extensive efforts to recruit potential converts to communism. They also recruited pro-Soviet prisoners to assist in the Soviet psychological warfare program (radio or front-line loudspeaker broadcasts).

On the whole, NKVD interrogators were well-trained, excellent linguists and skillful in gathering information from prisoners. They were also expected to produce results and failure was severely punished. Upon arrival at a prisoner-of-war camp, all prisoners

SECRET SECRET

SECRET SECRET

had to fill out long personal history questionnaires, a procedure which was repeated each time a prisoner was transferred to a new camp. Interrogators studied this form as well as all other interrogation reports on the prisoner and appropriate order-of-battle information before undertaking the interrogation of an individual prisoner. The slightest contradiction found in reports at any time, even when the interrogations had been made months apart, was cause for conducting additional interrogations.

All prisoners were interrogated at least once in the camps. Interrogations were almost always conducted at night, probably because of the prisoner's lowered resistance at that time, the psychological effect of darkness, the effect of fatigue, and the need to utilize the prisoner for labor during the day.

The initial camp interrogation was long and consisted of an exhaustive probing of all details of the prisoner's life history -- social status, education, political affiliations, occupation, and military service. Several interviews were usually required to complete this initial interrogation. Specialists, technicians, scientists, and other especially well-informed prisoners were subjected to long interrogations by appropriate specialists, and many prisoners were required to write treatises in the fields of their special accomplishments. High ranking and those learned or well-informed prisoners were sent to special interrogation camps for

SECRET SECRET

SECRET SECRET

more exhaustive interrogations. Particularly important prisoners, usually those who were important from a political standpoint, were interrogated at special NKVD prisons such as Lubyanka Prison in Moscow.

NKVD interrogators were skillful, and coercive methods were not necessary in the majority of cases. If need be, however, the NKVD applied unlimited duress to make obdurate prisoners talk, including those suspected of withholding information, of concealing their identity, or of lying. Several coercive methods were employed, ranging from the use of conventional torture methods (beatings, the infliction of wounds) to slow starvation in solitary confinement. Interrogators apparently used torture only by permission of higher authority, and care was taken to prevent the death or suicide of the prisoner under investigation. Most of the coercive methods involved the use of extreme fatigue: the prisoner was interrogated many successive nights and made to work during the day or else he was interrogated continuously for several days and nights by relays of interrogators while being kept awake under bright lights and made to maintain a particularly fatiguing physical position. Other prisoners were put in various types of solitary confinement where continuous light or darkness, extreme cold or heat, silence, fatigue, and systematic starvation drove them to the borderline of death and insanity. Mental torture was

SECRET SECRET

SECRET SECRET

used by threatening the lives of a prisoner's near relatives or threatening to destroy his honor by publishing false stories of his traitorous or punishable acts (homosexual relations, theft). One of the most effective methods used after the war was to threaten non-repatriation of the prisoner. Few if any prisoners could resist the coercive methods used by the NKVD, and, eventually, they revealed the information desired, even if the revelation meant death or life imprisonment.

The Soviet Union was determined to punish all war criminals among the prisoners, and the NKVD conducted many interrogations for purposes of discovering those who had committed atrocities. After the war, the Soviets adopted the policy of retaining as many prisoners as possible in order to provide a cheap labor supply and to prevent the return to their native lands of many intellectual and militaristic anti-Soviet elements among the prisoners. As a result, the laws were so defined that almost any prisoner could be convicted of a war crime if desired. Many interrogations were conducted for the purpose of making selected prisoners confess to war crimes or to bear witness against others so that they could be "legally" tried and convicted to long terms of hard labor. Such interrogations were not conducted for the purpose of gaining true information but to force the prisoners to perjure themselves. Coercive methods employed to secure such "confessions" corresponded

SECRET SECRET

SECRET SECRET

to those used to secure information from obdurate prisoners -- torture, fatigue, and solitary confinement.

There is evidence that the Soviets have made use of drugs in the interrogations of prominent political personages. Apparently these drugs were used to break the will and to partially destroy the mind of a prisoner, thus causing him to become compliant to the will of his prosecutors. There is no evidence that such drugs were used or had value for purposes of causing an obdurate prisoner to reveal true information that he would not otherwise divulge to his interrogators; rather, drugs were used when it was desired for political purposes to make the subject confess publicly to some political crime against the Soviet regime.

The use of informers was an important aspect of NKVD methods of interrogation. Agents or stool pigeons were omnipresent in prisoner-of-war camps and included Soviet agents, opportunists who volunteered their services in hope of favor or gain, prisoners recruited as stool pigeons by means of threats or promises, or prisoners who had been converted to communism in the camp propaganda program. A prisoner who had given false information during an interrogation was often confronted with information gathered by informers in a subsequent interrogation, accused of lying, and forced to tell all he knew.

SECRET SECRET

SECRET SECRET

In general, it may be stated that during the period covered by this study, Soviet interrogators were skillful in securing information from prisoners. When coercive methods were used, few if any prisoners had the mental or physical stamina to withhold information. The procedure for collecting and exploiting prisoner-of-war information was excellent, and information gathered by Soviet interrogators was used effectively in compiling both tactical and strategic estimates of enemy intentions and capabilities.

SECRET SECRET

SECRET SECRET

PART THREE
CHAPTER XI

SOVIET METHODS OF INTERROGATING JAPANESE
PRISONERS OF WAR

A. General Conditions in the Camps

On 8 August 1945 the Soviet Union declared war on Japan, and the Far Eastern Forces of the Red Army launched drives into Manchuria, Korea, and the southern part of Sakhalin Island. The Japanese surrendered unconditionally to the Allies on 14 August, and six days later the entire Japanese Fifth Kwantung Army of more than half a million men surrendered to the Russians. The Red Army did not cease operations, however, until 23 August, by which time it had occupied all of Japanese-held Manchuria, North Korea, Sakhalin Island, Dairen, Port Arthur, and the Kurile Islands.

In the course of this eleven-day conquest, nearly a million and a half Japanese soldiers and civilians became prisoners of the Red Army. A majority of these were transported into the Soviet Union or Soviet-held territory and were interned in more than 300 camps where they were forced to perform hard labor. The Soviets were not prepared to handle this many prisoners, and the lack of food, clothing, fuel, medicines, shelter, and proper transportation facilities combined with the severe

SECRET SECRET

SECRET SECRET

weather conditions in Siberia, the hard labor which the prisoners were forced to perform, and the poor sanitary conditions in the camps resulted in a high death rate among the prisoners.¹

The Soviets persistently refused to repatriate Japanese prisoners until December 1946 when, after considerable pressure had been brought to bear by other powers, they signed an agreement to repatriate 50,000 Japanese a month until all had been returned. The average number returned per month during the three years that followed was considerably less than the agreed figure, the repatriation process being characterized by many delays and much vacillation on the part of the Soviet Union. By November 1949, however, approximately 995,000 Japanese had been repatriated, and the Russians thereupon announced that all Japanese had been returned -- except for about 10,000 convicted war criminals who were serving their sentences in the USSR. According to official Japanese records, the Soviets had still not accounted for approximately 370,000 persons, including many women and children. Japanese figures had proved to be remarkably accurate for other areas from which Japanese had been repatriated, and there was much consternation in Japan, especially among the next-of-kin of the missing persons. Japanese and Allied authorities were forced to

358

SECRET SECRET

SECRET SECRET

conclude that a majority, at least, of these 370,000 unaccounted for persons were dead since the Soviets have persistently refused to shed any light on the matter.²

While the exact rate of mortality among Japanese prisoners held in the USSR is not known, thousands of repatriated Japanese have confirmed the fact that they were treated with great cruelty, especially during the first year and a half after the war when German prisoners were experiencing what they called the "punishment years." Information obtained from repatriates and compiled by Allied authorities in January 1947, for example, indicated that in 125 Soviet prisoner-of-war camps for Japanese the mortality rate was 24.5 percent during the period from September 1945 through December 1946.³ Living and working conditions in the camps were responsible for this high death rate. The work was of the hardest kind, lumbering, construction, and mining. The prisoners worked from eight to eighteen hours a day and were forced to meet unreasonable quotas. Even the injured and sick were made to work. Guards and foremen were harsh, and beatings were frequent. The food was entirely inadequate, and many died of starvation. The billets were crowded, unsanitary, and unheated. Medical care was inadequate; hospitals were understaffed and lacking in equipment and medicines.⁴

359

SECRET SECRET

SECRET SECRET

With the beginning of repatriation in 1947, conditions in the camps began to improve and the Communist indoctrination program, which had been largely neglected, was given much attention. Prisoners began to receive some pay for their work, they received a little time for leisure and recreation, food rations were increased, and the billets were improved. The Soviets were determined, however, to get as much work as possible out of the Japanese, and work quotas remained high. Only prisoners in very poor health were repatriated at first, and good workers were the last to go home. Large numbers of prisoners were tried and convicted of war crimes and these individuals were transferred to penal camps and not repatriated. All of these developments, it will be noted, paralleled those experienced by German prisoners of war.

B. Camp Organization and Administration

As noted earlier, all prisoner-of-war camps in the USSR were under the supervision of the MVD. Information concerning the organization and administration of the prison camp system obtained from Japanese repatriates is more detailed than that available from German sources. The Japanese, for instance, have indicated that there was one more echelon in the chain of command of the camp system than is illustrated in Figure 7, a chart which was based on information obtained from German sources. According

360

SECRET SECRET

SECRET SECRET

to the Japanese, the chain of command of the camp system was as follows:

Ministry of Internal Affairs (MVD)
Administration Control Board (Kenri In)
Administration Control Bureaus (Kenri Kyoku)
PW Districts (Chiku)
PW Camps (Shuyosho)
PW Branch Camps (Bunsho)⁵

The names applied to the organizations at the various administrative levels of the camp system differ from those given in Figure 7, but it may be assumed that these are differences in translation only, especially since four languages have been involved. The functions of the Administration Control Board as described by the Japanese, for instance, are the same as those ascribed to the Main Directorate of PW Camps by German repatriates. The Administration Control Bureaus, however, have not been mentioned in reports from German sources, and the Japanese ascribe considerable importance to this echelon of the system. One of these bureaus is alleged to have been established in each republic or province where prisoners of war were interned, each bureau being divided into seven sections as follows: Labor, Personnel, Political, Health, Planning, Supply, and Counter-intelligence. The latter section, known as OCHO (Operativny

361

SECRET SECRET

SECRET SECRET

Chekisky Otdel), was the operational investigation section which directed the camp interrogation program.

The area over which an Administrative Control Bureau had jurisdiction was divided into districts, and the district administration, in turn, exercised control over the camps and their sub-camps in the same manner described by German repatriates. (See Figure 7.) Between seventy and eighty districts have been identified by means of Japanese reports, three of which were divided into sub-districts (Shibu) which, in turn, were split up into branch camps. Information available from German sources on the camp system is limited but it may well be that the camps for German prisoners were organized as described by Japanese repatriates.

The camps for Japanese were guarded by MVD Escort and Convo troops as were the camps for German prisoners. Japanese repatriates have stated, however, that prisoners sentenced to life imprisonment or death had their cases reviewed by the Red Army. If such sentences were approved, the Red Army provided guards for the "life-termers," and executions were performed by Red Army soldiers.

C. Camp Indoctrination Program

The Soviets carried on an intensive indoctrination program among Japanese prisoners with the general objectives of extending

362

SECRET SECRET

SECRET SECRET

Soviet ideology into Japan by converting prisoners to communism before their repatriation and of training selected candidates to become the nucleus of a militant, pro-Soviet movement in Japan. The long-range political objective of the program was, of course, to bring Japan within the sphere of influence of the Soviet Union. The program was similar to that carried on in camps for German prisoners, but it was "skillfully adapted to the Japanese habit of thought; carefully phrased to the prisoner's current circumstances and to each stage of his development until the program itself became an integral part of the prisoners' lives and thoughts."

Selected converts to Soviet ideology from among the prisoners became secret informers in the prisoner-of-war camps and thus assisted the Soviets in their camp interrogation program; otherwise the indoctrination program falls outside the scope of this study, and only a brief treatment of the subject can be presented here.

The Soviets kept themselves in the background and used Japanese Communists as much as possible to carry on the indoctrination program among the prisoners. Many of these Japanese had been expatriates from Japan for years and had been trained in Moscow; others were screened from among the prisoners and put to work. As the program developed, converts from among the

363

SECRET SECRET

SECRET SECRET

prisoners were sent to special indoctrination schools and trained to carry on propaganda in the camps as well as to perform intelligence missions for the Soviets in parts of Asia and in Japan. An integral part of the scheme was the publication of the Japan News (Nippon Shimbun), a newspaper which was distributed throughout the camps and which carried on a greater part of the indoctrination work during the first year after the war. It was a propaganda organ which lauded the Soviet way of life and published inflammatory articles against American occupation forces and policy in Japan, against the Emperor system, and against former leaders of Japan who had brought about the downfall of that country.

In the camps, the indoctrination program went through four well defined stages. The first stage, lasting from March through December 1946, was "a negative phase designed to eradicate hatred for the USSR, ⁹ and abolish Emperor Worship and the military caste system." An anti-fascist group called the Friends' Society (Tomonokai) was organized, and prisoners were urged to join the group for purposes of holding discussions and hearing lectures. So few prisoners responded that both promises of better living conditions and threats of reprisals or delay of repatriation were used to increase the membership. Even then in a majority of the camps only about sixty percent of the prisoners enrolled.

364

SECRET SECRET

SECRET SECRET

A camp committee of a chairman and members selected from the ranks of the prisoners (who were especially pro-Soviet) planned the propaganda program, organized and directed the work of a number of committees, and integrated orders of the Soviet authorities into camp policies. The similarity between the Tomonokai and the antifa movement among German prisoners is at once apparent.

During the second stage, January through April 1947, a systematic educational program was introduced which was designed to inculcate theoretical principles of communism in the minds of the prisoners. Potential leaders were dismissed from labor and given concentrated short courses in the history and theory of communism; others were required to attend lectures and discussions in the evenings. The Tomonokai gave way to a so-called Democratic Group (Minshu) whose activities became less social and more openly political in nature. A traditional mistrust of both Russia and communism lingered among the prisoners, and in order to make the indoctrination program more acceptable, such words as "democratic" were temporarily utilized. Later, as relations between the USSR and the United States became more strained, such terms were dropped, and the movement was¹¹ frankly labeled communism.

365

SECRET SECRET

SECRET SECRET

The third indoctrination period, May through September 1947, laid special stress on denouncing American occupational policies in Japan and America's alleged imperialistic designs in Asia. The fourth period, lasting from September 1947 through November 1949, was the time during which most of the Japanese prisoners were repatriated to Japan and the indoctrination seemed to consist largely of an intensification of effort along propaganda lines already mentioned. Several so-called Youth Organizations were organized among the younger prisoners who had shown the most enthusiasm for communism. Members of these groups were given special ideological training, enjoyed favored treatment, and exercised tyrannical power over other prisoners in the camps. At the repatriation port of Nakhodka, prisoners were given a final intensive indoctrination course before they were sent back to Japan. Those not showing proper enthusiasm for communism were held behind for further training; as a result, almost all of the prisoners simulated an enthusiasm for the program, whether they liked it or not, and joined the Communist party simply in order to insure their return home.¹²

D. Camp Interrogation Methods

The methods used by Soviet interrogators in camps for Japanese prisoners were strikingly similar to those used in camps for German prisoners. This is not surprising since MVD

366

SECRET SECRET

SECRET SECRET

personnel conducted the interrogation program in both types of camps. The fact that German and Japanese sources come to such close agreement on essential features of Soviet interrogation methodology serves, of course, to increase the value that may be placed on the credibility of both sources.

Since the war between Japan and the Soviet Union lasted but a few days, there could have been no extensive field interrogation program, nor are there any available reports from Japanese sources on this matter. Two reports on the Soviet interrogation program in prisoner-of-war camps for Japanese, however, have been compiled by United States Army interrogation teams working under the direction of G-2, General Headquarters, Far Eastern Command.¹³ These teams interrogated numerous Japanese repatriates from Soviet prison camps concerning Soviet methods of interrogation. The results of these interrogations, plus four short papers on the subject voluntarily submitted by former Japanese prisoners, were included in the two reports which constitute most of the source material upon which this portion of the study is based, and lengthy excerpts from them have been included in Appendix VIII. Item 2 consists of a model interrogation written by a Japanese who had been pressed into service as an interpreter; this dialogue is worthy of careful study since it seems to be typical of the routine type of

367

SECRET SECRET

SECRET SECRET

interrogation to which a majority (that is, the less important) prisoners were subjected. No mention of the use of narcotics has been made by Japanese who had been held prisoner by the Soviets.

The following discussion on Soviet methods of interrogating Japanese will be brief because the source material is limited and because the methods were so similar to those used with German prisoners which have already been fully discussed.

The Soviet camp interrogation program was hindered by a lack of Japanese speaking personnel. Consequently, many linguists among the prisoners were pressed into service as interpreters as well as White Russians who had lived as expatriates among the Japanese in Manchuria. One source even mentioned the use of Soviet students of Japanese, all young women, who were sent to the camps to gain practical experience in the language. During interrogations the interpreters made frequent mistakes which were, as a rule, detrimental to the person being interrogated.¹⁴

Interrogators of Japanese prisoners were usually MVD officers of the rank of lieutenant, few of whom spoke Japanese. Although reports are not clear on this matter, it would seem that most of the interrogators were concentrated in the investigation sections (Ocho) of the district headquarters. Minor

368

SECRET SECRET

SECRET SECRET

investigations were conducted by camp political section personnel, and special investigators were sent from the district headquarters as needed. Important prisoners were sent to a prison in the vicinity of district headquarters and kept there for the duration of their investigations. In view of the shortage of linguistic personnel, it is logical to assume that the Soviets pooled interrogators and linguists in central locations in order to make most efficient use of them.¹⁵

In contrast to repatriated Germans, most of whom commented on the general professional competence of their interrogators in the camps, Japanese repatriates have frequently mentioned the poor quality of the interrogators in the camps for Japanese prisoners.¹⁶ On the other hand, the interrogators seemed to have been successful, as a rule, in obtaining desired information, and Japanese criticisms may have been based largely on the fact that the interrogators were handicapped by poor interpreters.

At the beginning of their imprisonment, all Japanese were required, as were all Germans, to fill out lengthy personal history forms which were carefully screened by the Soviet investigators.¹⁷ Subsequent investigations of a majority of the prisoners were routine and designed to clarify answers given on the questionnaire. From these personal history forms, however,

369

SECRET SECRET

SECRET SECRET

Soviet interrogators singled out certain categories of personnel for special investigations. The reception of information from a stool pigeon about a prisoner which differed from that given on the prisoner's questionnaire resulted in an immediate and special investigation of that prisoner. Job classifications were also made following the screening of the questionnaires, and technicians or especially well-informed prisoners were subjected to technical interrogations.

Prisoners undergoing interrogation were usually segregated from others during the period of investigation. Less important prisoners were kept at work during the day and interrogated at night. More important prisoners were put in a prison on less than the usual rations. Others undergoing more severe investigations were kept under close guard in solitary confinement on near-starvation rations. ¹⁸ Prisoners were sometimes summoned for investigation formally through camp headquarters; at other times they were summoned secretly, and their fellow prisoners did not know what had become of them. Prisoners suspected of war crimes, who constituted the largest group of those who underwent special interrogations seem to have been sent to one of several camps in the vicinity of Khabarovsk where special personnel and facilities were provided for the interrogation and trial of war criminals. Another such center seems to have been

370

SECRET

SECRET

SECRET SECRET

located at Nakhodka which was also the principal repatriation port where prisoners received a final course of indoctrination before embarking for Japan. ¹⁹

Methods employed by the interrogators show a close parallel to those used with German prisoners, so much so that, beyond listing them here, no further discussion will be presented:

Interrogations were generally conducted at night in a small room with a bright light focused on the face of the prisoner.

Interrogators used physical coercion only by permission of higher authority, though they often broke this regulation. A majority of the routine interrogations were conducted without the use of physical torture.

The prisoner was frequently accused of lying to keep him on the defensive. Threats and verbal abuse alternated with promises and patronizing kindness. Food was sometimes placed before a starving prisoner to persuade him to "talk."

The slightest inconsistency in a prisoner's statements was seized upon as evidence of lying and as an excuse for more harsh and extensive investigation.

The most frequently used (and most effective) threat was that of non-repatriation.

Prisoners were required to sign interrogation reports which they could not read.

Obdurate prisoners were subjected to physical and mental torture or to the "fatigue" method -- interrogation by relays of interrogators for several days until they became completely exhausted and consented to making a "confession."

Other obdurate prisoners were confined for long periods in various types of solitary confinement cells under the same conditions described by German sources. Systematic starvation, heat, and cold were parts of this treatment which practically always resulted in the "confession" desired by the interrogators.

371

SECRET

SECRET

SECRET SECRET

Informers among the prisoners in the camps and among those in the prison undergoing investigation were an important part of the investigation system. Soviet medical personnel also spied on the prisoners.

Aside from securing items of information concerning a prisoner's personal history and his military service, the Soviets seemed to have two principal objectives in their interrogations: (1) to secure evidence that Japan had intended to wage an aggressive war against the Soviet Union, and (2) to secure evidence of the guilt of "war criminals" among the Japanese prisoners. The first of these objectives stemmed, apparently, from a desire to have proof of Japan's aggressive designs so that in an eventual peace conference the Soviets would have more excuse to demand a harsher treaty (and one which would be more advantageous to the Soviet Union). The second objective had the same economic and political purposes as that pursued among German prisoners -- to retain as many prisoners as possible as slave laborers (living reparations) and to prevent the return to Japan of intellectuals, military leaders, scientists, technicians, and other classes of prisoners who would be of help in the rehabilitation of Japan as an anti-Soviet power.

The process of seeking out, interrogating, trying, and convicting selected Japanese prisoners as "war criminals" so closely parallels the process which took place among German

SECRET SECRET

SECRET SECRET

prisoners that there is need to present only a few additional details here. By the Soviet's own admission, at least 10,000 Japanese were held behind in the repatriation program. Personnel sought by the Soviets as war criminals were classed together under the Japanese term Zenshoku, and included field grade and general officers, all intelligence, counterintelligence and espionage personnel (those termed as Special Service or Tokumukikan personnel by the Japanese); civilian, military, and secret police (Kempeitai); former Japanese diplomatic personnel; any Japanese who had participated in partisan warfare against the Red Army; linguists (suspected of being connected with Japanese intelligence); specialists in aviation, electronics, bacteriology, and chemical warfare; and any persons formerly assigned to a number of specifically designated units. Records were screened, and prisoners who fell into the wanted categories were separated for investigation. These individuals were made to "confess" to their "crimes" as well as to reveal the names of guilty persons who had concealed their true names or former assignments. As with German prisoners, this program got underway when the repatriation process began in 1947 and continued through the next two years. The program was not particularly successful until after the Soviet sponsored Minshu movement had succeeded in gaining large numbers of converts who, persuaded

373
SECRET SECRET

SECRET SECRET

that true "democrats" willingly exposed all reactionaries, revealed the names of many Zenshoku who had hitherto been able to conceal their identity or former assignments.

Practically all Japanese repatriates have reported the extensive use of informers among the prisoners in camps for Japanese prisoners. As among the Germans, these informers were recruited from among those who had been converted to a pro-Soviet attitude -- members of the Tomonokai and the Minshu group. Others were opportunists who were recruited by means of promises of gain or of early repatriation. Some prisoners were forced into the role of a stool pigeon by threats and coercion. Japanese prisoners, as did German, found that they could not trust their closest friends.

E. Summary

Soviet methods of interrogating Japanese prisoners in prisoner-of-war camps closely paralleled those used in camps for German prisoners, although the linguist and interrogation personnel who dealt with the Japanese apparently were somewhat less skillful. Unlimited duress was used to make obdurate prisoners reveal information or "confess" to false statements. Large numbers of higher ranking officers, specialists, intellectuals, and anti-Soviet elements among the prisoners were

374
SECRET SECRET

SECRET SECRET

tried on trumped-up charges and convicted of war crimes in order to prevent their repatriation to Japan. Soviet methods of interrogation were apparently effective, whether the object was to secure true information or false "confessions," and few if any Japanese prisoners could resist these methods when coercion was used.

375
SECRET SECRET

SECRET SECRET

PART FOUR

CHAPTER XII

CONCLUSIONS

This study has demonstrated that intelligence agencies of the Soviet Union are fully aware of the value of prisoners as sources of information and that they have developed an efficient organization and an effective methodology in order to exploit prisoners for intelligence purposes. Prisoners have also been exploited by the Soviets for economic and political purposes. All three types of exploitation have

continued long after the close of hostilities, and certain categories of prisoners have been retained in the Soviet Union for political and economic reasons by the legal device of declaring them to be war criminals not entitled to the right of repatriation.

The Soviet Union has not adhered to the currently accepted code of international law in regard to prisoners of war and internees except, as in the case of war criminals, when it has been advantageous to do so. Reprisals, usually the most effective method of insuring a regard for international law, are of no avail against the Soviets who renounce as traitors their own personnel who surrender to the enemy. The interrogation of prisoners has been conducted with complete disregard for any

376

SECRET SECRET

SECRET SECRET

existing standards of humane conduct. Unlimited duress has been used to make unwilling prisoners reveal information or to force prisoners to perjure themselves in the furtherance of Soviet political objectives. Interrogation methods have been so ruthless that even the most strong-willed and conscientious prisoners have been forced to reveal all information in their possession. If necessary, Soviet interrogators have set about systematically to destroy the sanity of a prisoner in order to achieve desired results. The prisoner's life has been carefully preserved, however, so that he could be saved for further exploitation or formal execution. Strict precautions have been taken to prevent a prisoner under investigation from committing suicide.

In Soviet prisoner-of-war camps, the inmates have been forced to live and work under conditions that destroyed the lives of many and ruined the health of those who survived. Living conditions were improved in the camps and limited privileges granted to the prisoners only in order to improve their productive capacity or for propaganda purposes. The knowledge and skill of scientists, technicians, and skilled workers among the prisoners were exploited as completely as possible. Prisoners amenable to the Soviet indoctrination program have been given special training and returned to their

377

SECRET SECRET

SECRET SECRET

native lands to form the nucleus of a pro-Soviet movement and to act as espionage agents for the Soviet Union.

There is no reason to believe that the Soviets will change their attitude toward prisoners or conform to international law in the immediate future. They have apparently continued to develop and perfect their interrogation organization and methodology along lines adopted during World War II, and, if anything, they seem to be planning to exploit prisoners for political purposes even more in the future than they have in the past. Evidences of these trends may be observed in a report on interrogation methods used by North Korean interrogators (some of whom were Soviet officers) in the questioning of United Nations' prisoners late in 1950. The report falls outside the scope of this study, but it has been included as Appendix IX because it supports the findings of this study and indicates the direction which Soviet interrogation practices may be taking.

Because of the Soviet attitude towards international law regarding prisoners of war maintained throughout World War II and the period immediately following that war, considerable surprise was experienced in international circles when the Soviet Union participated in the framing of the Geneva Convention Relative to the Treatment of Prisoners of War of 12 August 1949. On signing this convention, however, the

378

SECRET SECRET

SECRET SECRET

Government of the Byelorussian Soviet Socialist Republic made three reservations, one of which is particularly significant in view of what is known about the Soviet program of prosecuting war criminals among prisoners. Article 85 of the new convention states: "Prisoners of war prosecuted under laws of the Detaining Power for acts committed prior to capture shall retain, even if convicted, the benefits of the present Convention."¹ In regard to this article the Soviets made the following reservation:

Article 85: The Byelorussian Soviet Socialist Republic does not consider itself bound by the obligation, which follows from Article 85, to extend the application of the Convention to prisoners of war who have been convicted under the law of the Detaining Power, in accordance with the principles of the Nuremberg trial, for war crimes and crimes against humanity, it being understood that persons convicted of such crimes must be subject to the conditions obtaining in the country in question for those who undergo their punishment.²

In view of what has been learned about Soviet methods of interrogating captured personnel, a number of recommendations can be made concerning (1) general policies which should be adopted to protect the security of any nation and its military forces opposing the Soviet Union, and (2) the indoctrination and training of troops who will fight against the Red Army and are thereby potential prisoners of the Soviet Union.

In regard to general policies, the following recommendations are submitted:

379

SECRET

SECRET

SECRET SECRET

- 1) More stringent security measures should be instituted to prevent military information from falling into the hands of the Soviets which, when used by interrogators, can be of value in identifying individuals among the prisoners likely to be possessed of important information.
- 2) Knowledge of important military secrets should be restricted to as small a circle of individuals as possible. This proposal is, of course, in conflict with the policy of informing all military personnel as completely as possible about the military situation and objectives in order to facilitate the intelligent direction of effort at lower levels of command. A line will have to be drawn between information which is vital to the execution of military operations at the various command echelons and information which under no circumstances should become known to the enemy.
- 3) Persons in possession of important military secrets should be protected against the danger of capture, first, by keeping them as far as possible from the front lines and forbidding them to fly over enemy territory and, second, by removing well-informed persons who have become encircled by air-lift or other available means if at all possible.

On the matter of the training and indoctrination of troops liable to capture by Soviet military forces, these recommendations are submitted:

- 1) More emphasis should be placed on the Troop Information and Education program in order to strengthen the political convictions of the troops. They should have a better understanding of why and for what they will be fighting as well as a better knowledge of the nature of the regime which they will be fighting against.
- 2) Troops should be made conscious of the harm done to their country, their unit, and to their former comrades in arms when, as a prisoner, they reveal information to the enemy.
- 3) Troops should know that if captured by the Red Army they can expect no protection from international law.

380

SECRET SECRET

SECRET SECRET

They should be taught in as striking a manner as possible how they will be treated if they become prisoners of the Soviet Union. This should have the effect of strengthening their resolve to fight when the odds seem against them and not to surrender when there is the least possible chance of survival by continuing the fight.

- 4) Troops should not be required to give only name, rank, and serial number to Soviet interrogators. Rather, they should be permitted to give a minimum of information about their units and personal history as required, but schooled to pretend ignorance of broader matters or of any secrets in their possession. Only by giving troops harmless information with which to "bargain" will the soldier be able to withhold vital data. This is offered as the safest possible solution to the problem which arises from the certainty that a determined interrogator is never actually "resisted," he can only be "satisfied." As an additional procedure which troops can practice to "satisfy" their Russian interrogators, they should allow themselves to be drawn into conversations on sociological and political matters - dissertations on which virtually all Russians will enter enthusiastically.

5) For their own protection, troops should be taught to act in a militarily correct and courteous manner when captured. Respect should be shown for the rank of captors with whom the prisoner comes in contact, and the prisoner should make it clear that he expects to be treated with the respect due to his rank (even if that treatment is not forthcoming). A prisoner should never be rude, sarcastic, or derogatory in his remarks to his captors and should refrain from mentioning the names of political or military leaders of the Soviet Union in an unfavorable light.

- 6) A prisoner of the Soviets should keep his answers to questions short and simple, and his statements should be true if possible. He should never change or add to his statements in subsequent interrogations. A prisoner caught in a lie by a Soviet interrogator may be forced by torture to reveal any secrets which he may have been successful in concealing up to that time. Prisoners who steadfastly keep to a simple, easily remembered, prefabricated "cover story" are likely to be ignored after a few interrogations. They should never boast of special skills or knowledges in order

381

SECRET SECRET

SECRET SECRET

to gain favor nor should they admit to the slightest knowledge of any alleged atrocities committed by friendly troops, even if the "atrociousness" is nothing more than the use of captured Soviet supplies.

7) Troops should be warned of the omnipresence of informers among prisoners and told to reveal no secrets even to trusted fellow prisoners since the latter may be subsequently forced to reveal all he knows. Soviet medical personnel often act as informers and are trained to seek confidences from wounded or sick prisoners. Troops should be indoctrinated against becoming stool pigeons among their fellow prisoners or otherwise acting as agents for the Soviet Union.

8) The Soviets often force prisoners to make radio or front-line loudspeaker broadcasts or to sign propaganda letters and leaflets designed to encourage desertion or disaffection among the ranks of the enemy. Troops should be taught to disregard any such propaganda, even if it seems to originate from comrades well-known to them who have become prisoners of the Soviet Army.

These recommendations are suggestions only. A number of them are in conflict with traditional concepts of proper and honorable behavior of a prisoner. Other suggestions are in conflict with regulations requiring American troops to reveal only name, rank, and serial number. Honorable behavior can be expected and security can be maintained, however, only if the enemy is honorable and adheres to generally accepted rules and customs of warfare. The Soviet Union has not treated prisoners honorably nor in accordance with the rules of warfare. It is obvious, therefore, that in the event of war between the Soviet Union and the United States it will be necessary for the latter to make some modifications in the indoctrination of troops and its security regulations.

382
SECRET SECRET

SECRET SECRET

NOTES AND CITATIONS

(Explanatory Note)

Much of this study is based upon a series of papers prepared by a group of former German officers working under the supervision of the Chief of the Historical Division, European Command (EUCCOM). Several of the individuals participating in the project had been prisoners of the Soviets; numerous repatriated Germans who had been prisoners of the Soviets were also interviewed in the course of preparing the studies. These separate papers are designated in the citations that follow under their code number, MS P-018 (a through f). Copies of these papers are on file in the Office of the Chief of Military History.

The other main sources of information were the Departmental Records Branch, Office of the Adjutant General, and the G-2 Document Library, GSUSA. Unless otherwise specified in the following notes, all German records were obtained from the former source; all others are on file with G-2. Other documents which have been especially helpful in the preparation of the study have been those prepared by the 7707th Intelligence Center, European Command (7707 ECIC) and by Headquarters, U.S. Forces in Austria (USFA Biweekly Reports). Much excellent source material has been furnished by U.S. Air Force Intelligence, Other documents have been secured from the Central Intelligence Agency, the Counterintelligence Corps, and Naval Intelligence.

The organization of the Red Army and of Soviet intelligence agencies as described is based principally on two publications of G-2, GSUSA: Survey of Soviet Intelligence and Counterintelligence and WD TM 30-430, Handbook on USSR Military Forces (1945).

The classification of each document used is indicated the first time it is cited by the symbols (R), (S), and (TS) -- Restricted, Confidential, Secret, and Top Secret respectively. Only a few Top Secret documents have been cited, usually only for the purpose of supporting information secured from less highly classified documents.

383

SECRET SECRET

SECRET · SECRET

NOTES AND CITATIONS

Chapter I

1. Training Film (Soviet), "Break-through of the Forward Defense Line" (Vzлом Perednogo Kraya Nemetskoj Oboronye), MID #3024 (R), Pt. 2.
2. WD TM 30-430, Handbook on USSR Military Forces, (C), Nov 45, Ch. V, p. 16.
3. Xenophon, one of the first military historians, recorded numerous instances in which important information was secured from prisoners during the retreat of "the ten thousand" Greeks from Asia Minor in 400 B. C. See N. C. Dakyns (trans.), Xenophon's The March of the Ten Thousand (Anabasis) (London, 1901), pp. 23, 25, 53-55, 86, 95, 98, 100ff.
4. "Six Million Prisoners of War," Fortune, XXVII, No. 2 (1943), p. 109. See also: "Retaining Prisoners of War," World Report, II (8 Oct 46), pp. 10-11.
5. See chapter in this study, "Soviet Methods of Interrogating Japanese Prisoners of War," Section A.
6. Nazi Aggression and Conspiracy (Washington, 1948), III, Document 081-PS, pp. 126-30. In a report dated 28 February 1942 a German military observer stated that 3,600,000 Russians had been taken prisoner during the first eight months of the war between Germany and the Soviet Union.

385
SECRET SECRET

SECRET SECRET

7. The only accurate figures available on the number of prisoners captured or lost by any one power during World War II are those compiled on the U.S. armed forces by the Prisoner of War Office of the Army and the corresponding agencies of the U.S. Navy and Marines. This information was compiled in October 1949.

Number of Americans taken prisoner by the enemy during World War II:

U.S. Army and Air Force	114,285
U.S. Navy	3,324
U.S. Marines	2,272
Total	119,881

These figures do not include Coast Guard and Merchant Marine personnel nor the thousands of American civilians who were interned by the enemy.

Approximately 3,500,000 Germans, 175,000 Italians, and 56,000 Japanese were either captured by the U.S. armed forces or transferred to the U.S. armed forces by other Allied Powers for processing and imprisonment during World War II.

See also: Martin Tollefson, "Enemy Prisoners of War," Iowa Law Review (1947), pp. 126-30. Mr. Tollefson, former Army officer and Chief of the Prisoner of War Operations Division of the Army in World War II, states that the number of prisoners held in prison camps in the United States during World War II was 435,788.

386
SECRET SECRET

SECRET SECRET

8. Japanese troops were given no instructions about their behavior upon capture, the implication being that a good Japanese would fight to the death rather than surrender. The Soviet Union considered surrender a kind of traitorous act, and after the war most Russians who had been captured were sentenced to terms of hard labor upon their repatriation.

9. Prisoners of War (Institute of World Polity, School of Foreign Service, Georgetown University [Washington, 1948]), p. 15.

William E. S. Flory, Prisoners of War (American Council on Public Affairs [Washington]), p. 7.

10. MS No. P-018b. This manuscript is one of a series of studies comprising PW Project 14 (MS P-018 a-f) dealing with various aspects of PW interrogation and the propagandizing of PW's. The project leader and contributors are former high-ranking German officers. Manuscripts of this series will hereafter be cited as MS P-018 a-f. Documents are filed in the Office of the Chief of Military History, SSUSA.

387
SECRET SECRET

SECRET SECRET

Chapter II

1. Hans J. Morgenthau, Politics Among Nations (New York, 1948) pp. 209 ff.
2. See STATE, Encyclopaedia Britannica, 1948 Edition.
3. Flory, Prisoners of War, pp. 7-23. See also: George A. Finch, The Sources of Modern International Law (Carnegie Endowment for International Peace, Div. of Inter. Law. Monograph No. 1, [Concord, 1937]). For shorter, yet comprehensive, essays on international law, see INTERNATIONAL LAW both in the Encyclopaedia Britannica and the Encyclopaedia Americana.
4. United States - Mexican Claims Commission, Opinions of the Commissioners, pp. 207, 233.
5. Flory, Prisoners of War, pp. 8-9.
6. Morgenthau, Politics Among Nations, p. 210.
7. Ibid., p. 215.
8. Ibid., p. 220.
9. Flory, Prisoners of War, p. 7.
10. Report of the International Committee of the Red Cross on its Activities During the Second World War (1 Sept 1939-30 June 1947), hereafter referred to as Report of the International Red Cross Committee (Geneva, 1948), I, pp. 368-70.

388

SECRET SECRET

SECRET SECRET

11. Ibid., p. 35.
12. Robert H. Jackson, The Nurnberg Case (New York, 1947), p. 127.
13. WD FM 27-10, Rules of Land Warfare, p. 2, par. 5 a.
14. United States armed forces personnel are required to obey treaty law implicitly, it being the responsibility of higher authority to determine and instruct those forces concerning the status of any agreements between the United States and any other power, but the right of any power to denounce or withdraw from a treaty is recognized. See: Instructions for the Navy of the United States Governing Maritime and Aerial Warfare, p. viii. Treaties often contain provisions outlining the procedure by which a contracting party may denounce and withdraw from an agreement, though treaties dealing with rules of warfare are generally made with the understanding that the treaty (which has been made in peacetime) cannot be denounced after hostilities have begun. This latter principle was expounded in one of the earliest formal treaties that included provisions concerning the treatment of prisoners, the one between the United States and Prussia in 1799, and also in Article 96 of the Geneva Convention of 1929. See also: T. A. Taracouzio, The Soviet Union and International Law (New York, 1935), p. 235.
15. Taracouzio, The Soviet Union and International Law, p. 236.
16. WD FM 27-10, Rules of Land Warfare, pp. 1-2.
17. Flory, Prisoners of War, p. 9.

SECRET SECRET

SECRET SECRET

Chapter III

1. (1) Flory, Prisoners of War, p. 11.
(2) Dr. Franz Scheidl, Die Kriegsgefangenschaft von der ältesten Zeiten bis zur Gegenwart (Berlin, 1943), pp. 1-2.
For examples concerning the treatment of prisoners in ancient times translated from ancient writings see pp. 16ff.
2. Scheidl, Die Kriegsgefangenschaft von der ältesten Zeiten bis zur Gegenwart, pp. 16-19. Alexander the Great, on one of his expeditions, met 4,000 Greeks whose ears, hands, and feet had either been cut off or mutilated by the Persians and then set on their way home to become a laughing stock and a warning.
3. Ibid., p. 1.
4. Flory, Prisoners of War, p. 1.
5. Report of the International Red Cross Committee, I, p. 438.
6. Lionel Giles (trans.), Sun Tzu's The Art of War (Harrisburg, 1944), p. 16.
7. (1) Ibid., pp. 47-48
(2) Herbert C. Fooks, Prisoners of War (Federalburg, 1924), p. 8.
8. Flory, Prisoners of War, pp. 11-12.
9. Plato, The Republic, Dial Edition (New York), Book V, pp. 205-09.
10. Flory, Prisoners of War, p. 12.

390

SECRET SECRET

SECRET SECRET

11. Scheidl, Die Kriegsgefangenschaft von der ältesten Zeiten bis zur Gegenwart, p. 20.
12. Flory, Prisoners of War, p. 12. See also: Scheidl, Die Kriegsgefangenschaft von der ältesten Zeiten bis zur Gegenwart, pp. 1-2.
14. James H. Robinson, Introduction to the History of Western Europe (Boston, 1924), I, pp. 214-25.
15. Scheidl, Die Kriegsgefangenschaft von der ältesten Zeiten bis zur Gegenwart, pp. 24-25.
16. Robinson, History of Western Europe, pp. 32-36.
17. Ibid., p. 246.
18. J. Fitzgerald Lee, "Prisoners of War," The Army Quarterly, III (1921-22), p. 349. This article contains numerous examples of prisoner treatment throughout the ages.
19. Robinson, History of Western Europe, p. 497.
20. Lee, "Prisoners of War," Army Quarterly, p. 349.
21. Ibid. See also: Scheidl, Die Kriegsgefangenschaft von der ältesten Zeiten bis zur Gegenwart, p. 27.
22. E. G. Trimble, "Prisoners of War," The Encyclopaedia of Social Sciences (New York, 1935), XII, pp. 419-21.
23. William Malloy (comp.), "Treaty of Peace and Amity, 4 June 1905, between the United States and Tripoli," U.S. Treaties, Conventions, International Acts, Protocols and Agreements, II, Article XVII, pp. 1791-92.

391
SECRET SECRET

SECRET SECRET

24. Scheidl, Die Kriegsgefangenschaft von der ältesten Zeiten bis zur Gegenwart, p. 27.
25. LAWS OF WAR, Encyclopaedia Britannica, 1948 Edition.
26. Flory, Prisoners of War, pp. 13-14.
27. (1) INTERNATIONAL LAW, LAWS OF WAR, GROTIUS, Encyclopaedia Britannica, 1948 Edition. (2) Francis W. Kelsey (trans.), Hugo Grotius, De Jure Belli ac Pacis (Oxford, 1925), Book I, Ch. I, pp. 33-50; Book III, Chs. XI - XIV, pp. 722ff.
28. Grotius, De Jure Belli ac Pacis, Ch. XIV, p. 769; Ch. IV, pp. 649-50.
29. Flory, Prisoners of War, p. 15.
30. LAWS OF WAR, Encyclopaedia Britannica, 1948 Edition.
31. Ibid.
32. Morgenthau, Politics Among Nations, p. 179.
33. INTERNATIONAL LAW, Encyclopaedia Britannica, 1948 Edition.
34. G.D.H. Cole (trans), Jean Jacques Rousseau's, De contrat social ou principes du droit politique (1762), Everyman's Library Edition (New York), Book I, Ch. 4, pp. 8-10.
35. David Niven (trans.), Charles de Montesquieu's, L'Esprit des lois (Glasgow, 1793), Vol. I, Book XV, pp. 283-84.
36. (1) Emeric de Vattel, Le droit des gens (1758), Vol. II, Book III, Ch. 8, Sec. 137; (2) Flory, Prisoners of War, pp. 15-16; (3) VATTEL, Encyclopaedia Britannica, 1948 Edition.

392
SECRET SECRET

SECRET SECRET

37. Flory, Prisoners of War, pp. 16-17. Eighteenth and Nineteenth century writers on international law whose works influenced the treatment of prisoners were: David Hume (1711-1776), Henry Wheaton (1785-1846), Daniel Webster (1782-1852), and James Lorimer (1818-1890). An important author who influenced humanistic thought was Jean Henry Dunant (1826-1910), the Swiss philanthropist who was one of the founders of the Red Cross.
38. Malloy, "Treaty of Amity and Commerce, 10 September 1785" and "Treaty of 1799," Treaties, Conventions, etc., II, Article XXIV, pp. 1477ff and 1486ff. This treaty provided for the right to send mail and packages to prisoners, prohibited the binding or shackling of prisoners, permitted the parole of officer prisoners, and specified that commissaries for prisoners be provided in prison camps.
39. (1) Lee, "Prisoners of War," Army Quarterly, p. 354; (2) Trimble, "Prisoners of War," Encyclopaedia of Social Sciences, p. 420.
40. (1) Flory, Prisoners of War, pp. 17-18; (2) Lee, "Prisoners of War," Army Quarterly, pp. 350, 354; (3) Edward Fraser, Napoleon the Gaoler (London, 1914), pp. 1-15; (4) Theodor A. Dodge, Great Captains, Napoleon (Boston, 1904), I, pp. 528-29.
- (5) DUROF, WILLIAM, Encyclopaedia Britannica, 1948 Edition.

393
SECRET SECRET

SECRET

SECRET

41. War Department G.O. No. 100, 1863, Arts. 48-134. A few of these articles pertain to the rules of land warfare in general, but most of them specifically pertain to prisoners of war. See also: Flory, Prisoners of War, pp. 18-20.
42. LAWS OF WAR, Encyclopaedia Britannica, 1948 Edition.
43. (1) Report of the International Red Cross Committee, I, pp. 11-12, 217; (2) Malloy, "Geneva Convention of 1864," Treaties, Conventions, etc., II, pp. 190³ff. Another convention in 1868 extended the provisions of the agreement to cover maritime warfare. The U.S. Senate consented to ratification of both conventions in 1882, although ratification was never exchanged between signatory parties.
44. (1) Flory, Prisoners of War, pp. 19-20; (2) LAWS OF WAR, Encyclopaedia Britannica, 1948 Edition.
45. Malloy, Treaties, Conventions, etc., II, pp. 2016ff. This was the occasion of the United States' first participation in an European multipartite diplomatic conference of this nature.
46. Ibid., "Convention with Respect to the Laws and Customs of War on Land," Ch. II, Arts. IV-XX, pp. 2049-51.
47. Ibid., Art. IX, p. 2050.
48. Ibid., "Geneva Convention of 1906, For the Amelioration of the Condition of the Wounded of the Armies in the Field," pp. 2183ff.

394

SECRET

SECRET

SECRET

SECRET

49. Ibid., pp. 2220ff.
50. Ibid., pp. 2269ff.
51. Ibid., "Hague Convention No. IV of 1907, Art. II, p. 2277. See also: "Hague Convention No. III of 1899," Art. II, p. 2046.
52. (1) Papers Relating to the Foreign Relations of the U.S., 1918, Supp. 2, pp. 48-49. Sec. of State Lansing in a statement to the Sec. Gen. of the War Council of the American Red Cross, 19 Aug 1917, said in part, ". . . In so far as the rules set forth in the convention are declaratory of international law, they are of course obligatory as being a part of the law of nations." (2) Final Report of Gen. John J. Pershing, 1920, p. 85. General Pershing instructed his Provost Marshal General to follow the principles of the Hague and the Geneva Conventions in the treatment of prisoners.
53. Trimble, "Prisoners of War," Encyclopaedia of Social Sciences, pp. 420-21. The Red Cross in its Ninth Conference, 1912, voted to enlarge the scope of its activities to include prisoners of war. Their representatives were allowed to inspect certain camps and to make reports on camp conditions which dispelled rumors concerning mistreatment.
54. (1) Ibid., p. 421; (2) Pershing's Final Report, pp. 85-86.

395

SECRET

SECRET

SECRET

SECRET

55. (1) Flory, Prisoners of War, pp. 22-23; (2) Eleanor C. Flynn, "The Geneva Convention of Treatment of Prisoners of War," The George Washington Law Review, II (1942-43), pp. 505-20. The most important of the war-time agreements were the Convention of Stockholm (Germany, Austria-Hungary, and Russia in May 1916); the Convention of Copenhagen (Nov 1917); the Franco-German Agreement (Apr 1918); the Anglo-Turkish Agreement (Dec 1917); the American-German Agreement (Nov 1918).
56. Report of the International Red Cross Committee, I, pp. 217-18.
57. International Law Association, Report of the 29th Conference (1920), p. 259; Report of the 30th Conference (1921), pp. 236-46.

396

SECRET

SECRET

SECRET

SECRET

Chapter IV

1. Papers Relating to the Foreign Relations of the United States, I, pp. 317ff.
2. Geneva (Prisoners of War) Convention of 27 July 1929, Art. 82.
3. Geneva (Red Cross) Convention of 27 July 1929.
4. WD TM 27-251, Treaties Governing Land Warfare, 7 Jan 44, p. 127. This manual does not list China but she had ratified the convention in 1935 according to Report of the International Red Cross Committee, I, p. 510.
5. Report of the International Red Cross Committee, I, p. 442.
6. Ibid., p. 443.
7. Ibid., see also: Telegram, State Dept File 740.00114 European War 1939/2108, 7 Feb 1942; Telegram, State Dept File 740.00115 Pacific War/ 16 2/3, 24 Feb 1942.
8. Report of the International Red Cross Committee, I, p. 35.
9. Ibid., pp. 442-509.
10. See records of the Military Tribunal for the Far East, International Prosecution Section, SCAP. Filed in Departmental Records Branch, AGO. At a Bureau Chief Meeting in Tokyo, May 1942, War Minister Tojo is reported to have opposed Lt. Gen. Mikio Uemura (Chief of PW Information Bureau) in regard to the latter's expressed intention of conforming to the Geneva Convention. Tojo insisted that prisoners undergo compulsory labor forbidden by the Convention.

397

SECRET

SECRET

SECRET

SECRET

11. Letter, Frank T. Cleverley, Administrator for Foreign Operations, American National Red Cross, to Capt. K. G. Stewart, OCMH, 28 Sep 49, Sub: Handling of Prisoners of War by the Soviet Union and by Germany during World War II. Author's file.
12. Report of the International Red Cross Committee, I, p. 409.
13. Ibid., p. 412.
14. Ibid., pp. 417, 430-33.
15. Ibid., pp. 404-36. In these pages is a complete account of the fruitless attempts made by the Committee to co-operate with the USSR during World War II.
16. Robert E. Sherwood, Roosevelt and Hopkins: An Intimate History (New York, 1948), pp. 557-58.
17. Ibid., p. 559.
18. Report of the International Red Cross Committee, I, pp. 510-14.
19. Ibid., p. 329.

398

SECRET

SECRET

SECRET

SECRET

Chapter V

1. Taracouzio, The Soviet Union and International Law, p. 9.
2. David J. Dallin, Soviet Russia's Foreign Policy 1939-1941 (New Haven, 1942), p. 21.
3. Ibid., p. 10.
4. Trends in Russian Foreign Policy Since World War I (Legislative Reference Service, Library of Congress [Washington, 1947]), p. 5.
5. David J. Dallin, Russia and Postwar Europe (New Haven, 1945), p. 73.
6. Ibid.
7. George Vernadsky, Political and Diplomatic History of Russia (Boston, 1939), pp. 434-36, 442.
8. Taracouzio, The Soviet Union and International Law, p. 237.
9. Fred L. Schuman, Soviet Politics at Home and Abroad (New York, 1946), p. 191. The exact dates of de jure recognition are as follows:
 - 1 February 1924 - Great Britain
 - 2 February 1924 - Italy
 - 13 February 1924 - Hungary
 - 20 February 1924 - Austria
 - 8 March 1924 - Greece
 - 15 March 1924 - Sweden
 - 31 May 1924 - China
 - 18 June 1924 - Denmark
 - 1 August 1924 - Mexico
 - 28 October 1924 - France
 - 20 January 1925 - Japan

399

SECRET

SECRET

SECRET

SECRET

The Treaty of Rappallo was not included in de jure recognitions since at that time Germany also was an ostracized nation.

10. Trends of Russian Foreign Policy Since World War I, p. 5.
11. Dallin, Russia and Postwar Europe, pp. 60-63.
12. Taracouzio, The Soviet Union and International Law, p. 269.
13. Ibid., p. 328.
14. Ibid., p. 329.
15. Ibid., p. 289.
16. Ibid., pp. 322-23. See also pp. 423-24 for the complete text of this proposal.
17. Ibid., pp. 323-25.
18. Ibid., pp. 319ff. Taracouzio predicted in 1935 that in case of war the Russians would probably discriminate against officer prisoners.
19. Geneva Conventions of August 12, 1949 for the Protection of War Victims (Dept of State Pub. 3938 [Washington, 1950]), p. 84ff, 235.
20. Ibid., p. 235. A significant reservation made by the Soviets in signing the 1949 Convention was as follows:

"The Byelorussian Soviet Socialist Republic does not consider itself bound by the obligation, which follows from Article 85, to extend the application of the Convention to prisoners of war who have been convicted under the law of the Detaining Power, in accordance with the principles of the Nuremberg trial, for war crimes against humanity, it being understood that persons convicted of such crimes must be subject to the conditions obtaining in the country in question for those who undergo their punishment."

400
SECRET

SECRET

SECRET

SECRET

Chapter VI

1. Unless otherwise noted, information on the Government of the USSR as presented in this study is based on the following references: (1) UNION OF THE SOVIET SOCIALIST REPUBLICS, Encyclopaedia Americana, 1948 Edition; (2) WD TM 30-944, Dictionary of Spoken Russian, 1945, p. 563; (3) WD TM 30-430, Handbook on USSR Military Forces (C), 1946, I - 6; (4) U.S. Office of Strategic Services, The USSR, Institutions and People, (C), 1945, pp. 22ff.
2. Translations currently accepted by U.S. Army Military Intelligence for the Russian terms Upravleniye and Glavni Upravleniye are, respectively, "Directorate" and "Main Directorate" (e.g., GRU - Main Intelligence Directorate). In many publications, including U.S. Army Military Intelligence manuals published as late as 1946, these terms have been translated as "Administration" and "Main Administration." Otdel is translated as "Section;" (e.g., RO - Intelligence Section). Segments of the General Staff formerly termed "divisions" are also designated as "directorates" in this study.
3. UNION OF THE SOVIET SOCIALIST REPUBLICS, Encyclopaedia Americana.
4. "The Supreme Military Council" of the Soviet armed forces is sometimes referred to in other publications, including

401
SECRET

SECRET

SECRET

SECRET

earlier U.S. Army Military Intelligence manuals, as "General Headquarters."

5. WD TM 30-430. Chapter III contains a complete discussion of the history of the changes that took place and copies of Tables of Organization and Equipment of various units of the Red Army.
6. MS P-018b.
7. The discussion of intelligence sections of the Soviet Army staffs is based on the following books or documents: (1) Study, ID, GSUSA, 1947, Survey of Soviet Intelligence and Counterintelligence (S), (hereafter cited as Survey Sov Int), Ch. III-IV; (2) Joint Intelligence Sub-Committee Report, Organization of Soviet Intelligence Services, Postwar (TS), (hereafter cited as Jt Int Sub-Com Rpt). (3) Brit Study, Soviet Intelligence System (TS), Nov 47 (MI3d/INT/17/48), S.A.L.O. (ML3c). (4) Rpt, Canadian Mil Attache, Ottawa, Canada, sub: Red Army Intelligence Organization (S), Feb 46. (5) WD TM 30-430, V - 1ff. In 1945 the chief director of the GRU was Col. Gen. Fedor F. Kuznetsov; the assistant director was Maj. Gen. Kissilov. According to Canadian Military Attache report, the GRU was divided into eleven principal "divisions" as of August 1945: Operations, Information, Special Duties, Special Technical, Personnel, Education, Special Communications, Administrative, Financial, Radio Communication, and Foreign Relations.

402

SECRET

SECRET

SECRET

SECRET

8. Soviet naval intelligence was relatively undeveloped and inexperienced during the period covered by this study and, furthermore, had very little to do with prisoners of war. It may be assumed that any interrogation methods employed by the Red Navy paralleled those used by the Red Army. For these reasons, no further attention will be given to Red Navy Intelligence methods in this study. See also (1) Jt Int Sub-Com Rpt, par. 7; (2) Brit Study, Sov Int System, p. 6.
9. Brit Study, Sov Int System. This study indicates that the Office of Information was organized into sections dealing specifically with military, economic, political, scientific, and air matters. It seems more likely, however, that principal subdivisions were made on a regional basis as shown in Figure 4.
10. Survey Sov Int, pp. 90ff. This source contains a detailed explanation and evaluation of Soviet methods of dissemination of intelligence reports.
11. Jt Int Sub-Com Rpt, pp. 24, 26.
12. WD TM 30-430, V, pp. 3ff. The Soviet "formation" (soyedinenye) has no exact equivalent in the U.S. Army, but it may be compared to a large-scale combat team.
13. Ibid., pp. 3-5.
14. Ibid., p. 5.
15. Jt Int Sub-Com Rpt, par. 16.

403

SECRET

SECRET

SECRET

SECRET

16. Survey Sov Int, p. 107.
17. Ibid., pp. 111-12.
18. Ibid., p. 117.
19. Ibid., pp. 121-22.
20. Ibid., pp. 126.
21. Ibid., pp. 123-24.
22. Hq EUCOM 258th Interrog Team, T/16 Apr 48, NKV Doc (translation), Organization and Mission of the Soviet Secret Service, (TS), (hereafter cited as NKVD Document), p. 35 makes mention of an Evaluation Division of the RO at army level. It may be assumed that this is another designation for the Information Group. The interpreters of the information group presumably assisted in direct interrogations conducted by the Interrogation Group at this level. Information is lacking as to the exact table of organization and strength of an army RO.
23. Survey Sov Int, p. 126.
24. Ibid., pp. 124-25.
25. Ibid., pp. 127-30. Evacuation procedures are delineated later in Chapter VII.
26. Ibid.
27. Interrogation Rpt, 23 Mar 43, in G-2 file of III Panzer Corps, Anlagen II zum Taetigkeitsbericht, Abt IC, 4. III.-22. VII. 1943 (hereafter cited as III Panzer Corps G-2 file). DRB, AGO.

404

SECRET

SECRET

SECRET

SECRET

28. Ibid. This source stated that (in the spring of 1943) his RO consisted of a chief (major or lieutenant colonel), two aides (captains), one interpreter, two or three clerks (enlisted men or women), and a man in charge of maps who, at the same time, was also a draftsman.

29. Ibid. The Soviet officer previously mentioned made revealing comments on the situation as it existed in his organization:

The intelligence office is directly under the jurisdiction of the chief of staff. Co-operation with the operations section leaves much to be desired - there is almost constant friction between the two sections. There were no interpreters at brigade levels. Interrogation takes place only at corps level. The chief of staff gave orders to the intelligence officer who acts upon his own in handling down reconnaissance missions.

30. Survey Sov Int, pp. 127, 129.

31. (1) Ibid., pp. 130-33. (2) NKVD Document, p. 35. According to the latter source, the reconnaissance company was under the direct command of the division commander, but in practice it was under the control of the intelligence officer. See also Interrogation Rpt, dated 21 Jul 44, in G-2 file of Third Panzer Army, Anlagenband E zum Taetigkeitsbericht Nr. 12, Abt. Io/A.O. 1. VIII. - 30. IX. 1944, (hereafter cited as Third Panzer Army G-2 File). This document is a German report of an interrogation of a captured Soviet divisional intelligence officer. According to him, the divisional reconnaissance company consisted of three officers and 100 enlisted men divided into two platoons. Combat

405

SECRET

SECRET

SECRET

SECRET

reconnaissance by this company was undertaken only on the order of the division commander when all other actions had failed to result in the capture of prisoners. As at corps level, this officer indicated that friction usually existed between the operations officer and the intelligence officer.

32. The Soviet intelligence officer referred to in the previous footnote (Third Panzer Army G-2 File) made the following comments on activities of the divisional RO:

Every ten days, certain objectives which might yield prisoners, such as bunkers or trench sections, are designated. The mission is not performed by troops manning the trenches, but by the reconnaissance company. Scouts, singly or in pairs, are also employed for such missions. Incoming reports are to be entered into the war diary at 1200 and 1600. A summary of all messages from the OPs and the results reported by the reconnaissance company are incorporated into a consolidated report and transmitted to corps at 1300. Consolidated reports covering ten-day and monthly periods are also made.

During the advance, 3 men from the reconnaissance company, who are equipped with telephones, are attached to each battalion of the advancing troops. These attached telephone operators report to the rear their own and the enemy situation, with special emphasis on the flanks. They report the time, strength, direction, and duration of enemy counterattacks. The transmittal of reports to the intelligence section takes approximately 30 to 40 minutes. In most instances, decisions are made on the basis of these reports, unless reports from the operations section, transmitted via regiment, are in definite conflict. In such instances, a special reconnaissance officer is sent forward. Intelligence reports which division receives directly and reports which division receives through regimental channels are incorporated into a consolidated report and forwarded to corps.

406

SECRET

SECRET

SECRET

SECRET

33. Survey Sov Int, pp. 131-32.

34. Ibid.

35. MS P-018b.

36. WD TM 30-430, I - 26. The duties of the Main Political Directorate can be roughly compared, in part, to those of the Troop Information and Education Section of the U.S. Army on this activity.

37. Ibid., I - 4, 5.

38. The succeeding history of the Soviet secret service is based on the following books and documents unless otherwise noted: (1) Survey Sov Int, Ch II, pp. 23-24; (2) 7707 EUCOM IC, Guide for Intelligence Interrogation of Eastern Cases (S), Apr 48, Ch XXIX, pp. 205-19; (3) Brit Study, Sov Int System, Ch 3, pp. 1-3; (4) NKVD Document, pp. 6-9; (5) CIC Doc, Soviet Agents Security and Counter-Espionage in the Theater of Operations East Front (S), pp. 5-8.

39. Because of differences between the Russian and English alphabets, various translators have in some instances given different English "alphabetical" designations to the same Soviet agency. Here the alphabetical title which seems to be used most frequently by translators has been arbitrarily selected. Since the titles of most of the organizations are long and rather ponderous, the alphabetical designations are used in the text

407

SECRET

SECRET

SECRET

SECRET

after an initial listing of the full title. These titles with their Russian equivalents (in the English alphabet) may be found in the glossary appended to this study.

40. Smersh is a contraction of Smert Shpionam (meaning "Death to the Spies") which was the title of a Vyshinsky pamphlet promoting that slogan. Smersh was dropped as a title of the organization at the close of the war. See USFA (United States Forces in Austria), Special Weekly Report No. 36 (TS), 11 Jul 47, Pt. II, pp. 1-13.

41. Parallel developments in the field of counterintelligence took place in the Red Navy as well.

42. German staff officers writing on this subject after the war (MS P-018b), state that at the start of the war all camps were operated by the Soviet Army and that "large numbers of camps were turned over to the NKVD. . . about the middle of 1943." Other sources (Soviet Field Regulations, etc.) indicate, however, that all prisoner-of-war camps were under the jurisdiction of the NKVD throughout the war.

43. WD TM 30-430, IV - 4ff; Survey Sov Int, pp. 59-61. The organization and functions of the NKVD apparently remained the same upon its change to a ministry, the MVD, in 1946.

44. WDGS Int Rpt No. RT-194-50 (CI-526), 21 Feb 50, Sub: Administration of PW Affairs by the MVD (S). This report was

408
SECRET

SECRET

SECRET SECRET

evaluated as F-6 (unconfirmed information) by the issuing agency, but the information is believed to be reasonably correct and has, therefore, been included in the text of this study.

45. The source believed that PW camps designated by four digit numbers beginning with seven were administered by Department Seven of the MVD, numbers beginning with an eight were labor camps under the Soviet Army, and those beginning with two or five, while under MVD administration, were under the Ministry of Public Health (Narkomsdrav). Another report based on statements by three returned PW's (USFA Special Wkly Rpt No. 53 (TS), 28 Nov 47, pp. 12-19) indicated that the seven was added to camp numbers in March and April 1947 for purposes of facilitating censorship of mail. (No criminal or political prison camps began with the numeral seven). Officer camps usually had lower numbers than those for enlisted men, sometimes only two digits following the seven. The digits following the seven indicate the base camp of a certain area; affiliated camps were indicated by adding a slash and the number of the subsidiary installation (7528/1, 7528/2, etc.). Some affiliated camps were as far as 250 km. from the main camp.

46. Probably the Main Administration of Interior Troops. (See Figure 6.) Escort and convoy troops were uniformed and usually wore red epaulets which bore the regimental number and the letter "K."

409
SECRET

SECRET

SECRET

SECRET

47. The source did not define differences between convict, training, and prisoner-of-war camps in this report.
48. This and the following information about prison camps is from MS P-018b.
49. There have been practically no returnees from these punishment camps, inmates were not permitted to correspond with relatives or prisoners in other camps, and the Soviet Government has refused to release any information about any of the camps.
50. For an excellent account of the organization and administration of forced labor camps (under the Main Directorate of Labor Camps) under the MVD see Rpt No. R-47-48, ODI Files, USFA, 24 Jun 48, sub: Forced Labor Organization MVD. Appendix "A" of this report is a chart which depicts the organization of the Main Directorate and of the labor camps.
51. MS P-018b.
52. USFA, ODI, IC, Special Bi-Wkly Rpt No. 72, Apr 47, (S), Pt. III, Item 2, p. 6. This camp was alleged to be No. 7027/2 and located near the Volga Canal 22 miles south of Moscow. Though not so stated in the report, it may be assumed that the camp was under the jurisdiction of the NKVD.
53. The report refers to this as the MVD Centrale Butilka (Bottleneck -- possibly a prison slang term for this institution) located on the Moravska Ulitsa (Street) in Moscow. The notorious Lubyanka Prison in Moscow was also an important NKVD (and NKGB) interrogation center.

410

SECRET

SECRET

SECRET

SECRET

54. WD TM 30-430, IV - 4, 5. The Security Regiment: performed many tasks undertaken by the Corps of Military Police in the U.S. Army.
55. Survey Sov Int, pp. 60-61.
56. WD TM 30-430, IV - 5.
57. Ibid.
58. Especially important political personages among the prisoners, particularly leaders of the Nazi party who fell into Russian hands after the defeat of Germany, were interrogated by NKGB personnel.
59. As mentioned previously, GUKR units at front and army level were titled UKR NKO; at corps and divisional level, OKR NKO.
60. NKVD Document, pp. 55-56. This document is a German study of Soviet intelligence methods based largely on captured documents and PW statements. In this study it is stated that co-operation between the OO NKVD and the Main Political Directorate was mandatory. The basis for this statement is a Soviet field order which fell into German hands early in the war and which stated, in part, "To all Military Courts of the Armies: By decree of the State Committee for Defense. . . , all OO NKVD offices are ordered to combat relentlessly all spies, traitors, saboteurs, and deserters. The successful execution of such an important mission necessitates the closest collaboration between the OO's and the Political Leader Corps of the Red Army."

411

SECRET

SECRET

SECRET

SECRET

61. Survey Sov Int, p. 49. The GUKR had no training responsibilities or school facilities; training of personnel to be assigned to Smersh units continued to take place in NKVD or NKGB schools.

62. Ibid., pp. 49-54.

63. Ibid., p. 51. Available documents differ only slightly in estimates as to the number of personnel assigned to Smersh units. For further information see (1) NKVD Document; (2) USFA Special Wkly Rpt No. 36; (3) CIC Doc, Soviet Agents Security, 1p. 7ff.

64. NKVD Document, p. 49. The NKGB carried on a surveillance program among the civilian population that was only slightly less intense than that conducted in the armed forces.

65. Soviet prisoners or deserters in describing to the Germans what they knew of the operations of Smersh units often observed that persons taken into custody by Smersh units (both Russians and prisoners of war) frequently were never heard of again. While it may be assumed that the fate of some of these individuals was imprisonment rather than death, the secrecy surrounding such actions was probably a part of a carefully planned program of terror.

66. NKVD Document, p. 52.

67. (1) Ibid., (2) USFA Special Wkly Rpt No. 40, 8 Aug 47, Pt. II, pp. 5-12 (TS). Special teams of the NKVD and the NKGB

412

SECRET

SECRET

SECRET

SECRET

investigated the populations of recovered territories. The Smersh units attached to the Red Army were interested primarily in the civilians in the immediate area occupied by their military units.

68. USFA Special Wkly Rpt No. 40, pp. 5-12.

69. NKVD Document, p. 52.

70. Ibid., p. 55.

71. Survey Sov Int, pp. 75-76. During wartime the Main Intelligence Administration (GRU) was responsible for the specific direction of strategic intelligence in military fields. The Central Committee of the Communist party was charged with the over-all control of strategic intelligence and the specific direction of nonmilitary intelligence.

72. Survey Sov Int, pp. 26-27. During the great purge of 1937-39 approximately 35,000 senior officers of the Red Army were arrested; most of them were never returned to their posts.

413

SECRET

SECRET

SECRET

SECRET

Chapter VII

1. MS P-018b.
2. Ibid.
3. Ibid.
4. Victor Kravchenko, I Chose Freedom (Garden City, 1946), pp. 364-65.
5. GMSD RS 279. For an English translation of this document, see CIA Document OO-W-1009 (C), pp. 8-20. See also GMSD 59710/2, Eleventh (German) Army, March 1942.
6. The author's contention is supported by one German General as follows: "The German generally believes that he was always confronted by the NKVD. This notion is incorrect. . . . The prosecution of criminal acts of a political character is not a responsibility of the MVD . . . but of the KGB. The latter agency has also conducted numerous interrogations of PWs.
7. Following the nonaggression pact with Germany in August 1939, the propaganda in respect to Germany as an enemy of the Soviet Union had been temporarily reversed. This resulted in much confusion of mind among front-line Russian troops and may have been responsible for the surrender of many Russian troop units almost without a struggle early in the war. See Kravchenko, I Chose Freedom, pp. 365ff.
8. (1) DA Pamphlet No. 20-230, Russian Combat Methods, Nov 50

414
SECRET

SECRET

SECRET

SECRET

- (R), pp. 91-92. (2) Study Deutsche Kriegsgefangene in der Sowjet - Union [German PWs in the Soviet Union] in Anti-Komintern File, Abt. Sowjet - Union Archiv, EAP - 116/95 (hereafter cited as Anti-Komintern File EAP 116/95). (3) MS P-018b.
9. Special Interrogation Rpt, dtd 25 Aug 44, in G-2 file of X Corps, A. K. Ic, Anlage 6, Gefangenen - Vernehmungen, 16. VII. - 15. X. 44.
10. MS P-018b.
11. Leaflet carrying excerpt from Soviet Government Directive No. 1798, issued 1 July 41, found in XXVI Corps G-2 file, Ic Anlagenmappe VI zum T. B., Russische Flugblätter [Russian Propaganda Leaflets] 1. I. - 30. VI. 43.
12. MS P-018b.
13. Anti-Komintern File EAP 116/95.
14. Interrogation Rpt, dtd 22 Mar 43, in III Panzer Corps G-2 File.
15. Brief summary of Stalin Order No. 171, dtd 8 Jul 43, in Interrogation Reports, Pt IV, dtd 10 Sep 43, found in G-2 file of Ninth Army Anlage 5 zum Taetigkeitsbericht der Abt Ic/A. Q., 18. VIII. - 31. XII. 43. (hereafter cited as Ninth Army G-2 File).
16. Kravchenko, I Chose Freedom, pp. 405-06.

415
SECRET

SECRET

SECRET

SECRET

17. MS P-018b.
18. Trial of the Major War Criminals Before the International Military Tribunal (Nuremberg, 1947), XXVI, Doc No. 884-PS. See also, Nazi Conspiracy and Aggression, III, p. 59.
19. (1) Nazi Conspiracy and Aggression, III, Doc No. 1056-PS, p. 710. (2) Ibid., Doc No. 338-C. (3) Sherwood, Roosevelt and Hopkins, pp. 557-59. Despite the urging of Roosevelt in 1942, Molotov firmly declined to negotiate any agreement with the Germans in regard to prisoners.
20. Red Army Field Service Regulations, 1942, (S), p. 68, par. 199-202, translated from the Russian under the direction of the Chief of General Staff, Canada. USA CIC.
21. MS P-018b. As has been previously noted, the author differs somewhat with German authorities on this matter. The author contends that the Red Army still had considerable latitude in gathering tactical information, even though the NKVD did usurp the field of strategic intelligence.
22. Ibid.
23. Ibid. The paragraphs a through g in the text are paraphrased with the author taking the liberty of disagreeing slightly with the source on the role of the NKVD, especially in paragraph d.
24. (1) Interrogation Rpt, Directives for the Interrogation

416

SECRET

SECRET

SECRET

SECRET

of PW's by Reconnaissance Officers of the Red Army, dtd 11 Aug 44, in OKH/Branch Foreign Armies East, Bd. /Vol.7 73 a.2. Kriegsgefangenenwesen, 30.VI.44 - 28.III.45 (hereafter cited as German PW affairs file, Foreign Armies East). (2) See also Survey Treatment of German PW's in the Soviet Union, dtd 18 Jun 44, in folder OKH/Branch Foreign Armies East, Behandlung der deutschen Kgf. in der SU (hereafter cited as German PW Survey, Foreign Armies East). Both of these documents, dated 1944, indicated that below divisional level the army was given a free hand to gather combat information in much the same manner as in 1941-42.

25. Study Deutsche Kriegsgefangene in der Sowjet-union, in Anti-Komintern File EAP 116/195. See Appendix II, Item 1, for text. The original version of this order in Russian is not available. The German translation which is cited here was found in a study prepared for the Chief of the Security Service and the SD (Security Service). This translation is incomplete, paragraphs 6, 9, and 10 of the original 12 paragraphs having been omitted. The German study cites this document in order to demonstrate that the law pertaining to prisoners of war in the Soviet Union, dated 1 Jul 41, was a "propaganda lie." A more complete version of Order No. 001 is found in German PW Survey Foreign Armies East /H/3/682/ which varies from the other

417

SECRET

SECRET

SECRET

SECRET

version in some respects and which contains the missing paragraphs. Since the Russian version is not available, it is impossible to state which version is more correct, but the English translation appearing in Appendix II, Item 1, is deemed by the author to be of sufficient authenticity to support contentions that Russian evacuation procedures resulted in the death of many German prisoners.

26. Special order (translation) dtd 7 Jul 44, by HQ 16th Infantry Division, found in Third Panzer Army G-2 File. See Appendix II, Item 2 of this study. A German translation of a Russian Special Order (Russian version not available) signed by the Chief of Staff and the Division Intelligence Officer of the (Russian) 16th Infantry Division and addressed to the 156th Rifle Regiment. Two similar orders, issued by the 226th Inf. Div. and the 8th Mechanized Corps, respectively, may be found in German PW Survey, Foreign Armies East [H/3/682]. These orders mention the shooting of prisoner of war by Red Army soldiers.

27. Directive on the Political Interrogation of Captured Enlisted and Officer Personnel, dtd 3 Oct 41, in document file of Army Group North, Beutebefehle, Ia/AO, 15.IX.41 - 2.I.42. The German translation of this document is dtd 19 Apr 42. See Appendix III, Item 1 of this study.

418
SECRET

SECRET

SECRET

SECRET

28. Guide for the Political Interrogation of PW's, dtd 28 Mar 42, in G-2 file of 3rd Panzer Division, Anlage II zum Taetigkeitsbericht, Ic, Ausgehende Meldungen, Akte I, Russland, 7.II.-31.VIII.42. See Appendix III, Item 2 of this study.

419

SECRET

SECRET

SECRET

SECRET

Chapter VIII

1. Jt Int Sub-Com Rpt, p. 27.
2. MS P-018b.
3. Ibid.
4. Ibid.
5. Ibid.
6. Unless otherwise noted, this section of the study is based on information found in the following two documents: (1) NKVD Document, pp. 20-23; (2) Survey Sov Int, pp. 80-84.
7. NKVD Document, p. 22. This order was classified as "very urgent" and "top secret."
8. Ibid. This does not pretend to be a complete list of the subjects taught in the College of Intelligence.
9. According to the NKVD Document this school was said to have been closed toward the end of the war. The Report of the Joint Intelligence Sub-Committee states that "a Higher Intelligence School for the Red Army General Staff was identified in 1944, and there were undoubtedly other schools in existence about which no information is available."
10. Interrogation Rpt, Directives for the Interrogation of PW's by Reconnaissance Officers of the Red Army, dtd 11 Aug 44, in German PW affairs files, Foreign Armies East. See Appendix IV of this study.

420
SECRET

SECRET

SECRET

SECRET

11. Jt Int Sub-Com Rpt, pp. 36ff.
12. Survey Sov Int, p. 85. This advanced school and other secret service schools were all under the NKVD at the beginning of the war. When the GUGB (which had been an NKVD Main Directorate) became the NKGB in 1943, the Advanced School probably came under the jurisdiction of the latter commissariats along with a number of other NKVD institutions. Since all personnel of both commissariats had originally been members of the NKVD, the difference between NKVD and NKGB schools and personnel, at least during the war, was more academic than real. Thus, 00 NKVD personnel became OKR NKO Smerish personnel (and nominal members of the Red Army) in 1943, but replacements for these latter units were drawn from NKGB schools (which had formerly been NKVD schools).
13. Ibid.
14. MS P-018b.
15. Both the Red Army intelligence and the counterintelligence agencies operated numerous schools both for agents who were to be committed in foreign territory and for radio intelligence and other types of intelligence personnel. Since interrogation did not come under their jurisdiction, such schools have been ignored in the text.

Short training courses for both military intelligence and

421
SECRET

SECRET

SECRET

SECRET

counterintelligence personnel inaugurated during the war have apparently been continued since the war. A German prisoner who did carpenter repair work at one such school in Moscow from 1945 until 1949 stated that three-month courses for officers of the Soviet Army, Air Force, MVD, and the Police were given at that particular school. See Rpt No. RT-524-50 (CI-1027), MVD School in Moscow, USSR (S), Hq 7707 EUCOM IC, 25 May 50.

16. (1) Interrogation Rpt, dtd 29 Aug 43, in file on Russian military schools, OKH/Branch Foreign Armies East, 28b, Schulen, S.I.43-10.III.45. (2) 7707 EUCOM IC, Rpt CI-SIR/56, 29 Oct 47 (TS).

17. (1) ODDI, USFA, Jul 48 (Rpt date: 18 Oct 49), sub: Military Institute of Foreign Languages. Source: Soviet deserter. Evaluation: C-2 (S). (2) n. 16(2), Ch. VIII.

18. MS P-018b.

422

SECRET

SECRET

SECRET SECRET

Chapter IX

1. DA Pamphlet No. 20-230, pp. 13-16.
2. Ibid., p. 90.
3. Ibid., p. 97.
4. MS P-018b. The information in the following passage, unless otherwise noted, is based on this source.
5. Mikhail Koriakov, I'll Never Go Back (New York, 1948).
6. MS P-018b.
7. Ibid.
8. Rpt, Reaction of Russian PW to Questioning, C.S.D.I.C., G.R.G.G. (U.K. Report), 343 (C), 16 Aug 45 (S), par. 45.
9. MS P-018b.
10. Rpt 00-B-9037, CIA, 14 Dec 48, sub: Vorkula Concentration Camp, (C), par. 24-25. See also, Koriakov, I'll Never Go Back, p. 130.
11. Report of the International Red Cross Committee, pp. 419ff.
12. Study Deutsche Kriegsgefangene in der Sowjet-union in Anti-Komintern File EAP 116/95. According to this document Soviet authorities informed neutral representatives that they were not interested in Red Army personnel captured by the Germans. Since these soldiers had not fought to the very last, they were considered traitors, who would be executed as soon as they were repatriated.

423

SECRET

SECRET

SECRET SECRET

13. (1) Interrogation Rpt, dtd 21 Jul 44, in Third Panzer Army G-2 file. (2) Special Interrogation Rpt, dtd 25 Aug 44, in G-2 file on X Corps, A.K. Ic, Anlage, Gefangenen-Vernehmungen, 16.VII.-15.X.44.
14. Interrogation Rpt, dtd 21 Jul 44, in Third Panzer Army G-2 file. According to this source, returned Soviet officers were made privates in disciplinary companies. After being wounded they were considered rehabilitated and their rank was restored.
15. (1) Ibid., (2) USFA Special Wkly Rpt No. 40 (TS), 8 Aug 47, Pt. II, pp. 5-12, (3) Rpt No. 1004 (C), Ninth Service Command, Fort Douglas, Utah, 3 Jan 45, par. 19. DRB, AGO.
16. 54th Order of the Peoples' Commissar for Internal Affairs of the USSR, 1942 (German translation) in Anti-Komintern file Abt. Soviet-Union Archiv, EAP 116/57. See also Rpt No. 1004, Ninth Service Command, par. 19, 22. (So far as official orders were concerned, the Russians seemed to specify that only traitors, i.e., deserters, would be punished. In practice it seems that all who were taken prisoner were suspected traitors until proved innocent.)
17. USFA, Special Bi-Wkly Rpt (C), No. 72, 20 Aug 48, Item 1.
18. (1) Ibid. (2) Rpt No. 70 (S), 23 Jul 48, Item 1, and (3) Rpt No. 82 (S), 7 Jan 49, Item 2.

424
SECRET SECRET

SECRET SECRET

19. Kravchenko, I Chose Freedom, pp. 405-06. Kravchenko quotes an official of the Administration of Forced Labor Camps (GULAG) who was being pressed to supply a certain commissariat several hundred prisoners for a rush assignment as saying: "But, Comrade, . . . be reasonable. After all, your Sovmarkom is not the only one howling for workers. . . . Naturally everyone thinks his own job is the most important. What are we to do? The fact is, we haven't as yet fulfilled our plans for imprisonments. Demand is greater than supply."
20. Rpt 1004, Ninth Service Command, par. 6.

425
SECRET SECRET

SECRET

SECRET

Chapter X

1. MS P-018b. Discussion of the five phases of the war which follows is based on this source unless otherwise noted. According to U.S. sources, the agreement of the Foreign Ministers to repatriate German prisoners of war by 31 Dec 48 was reached on 23 Apr 47, and the Governments submitted their repatriation plans in August 1947. Obviously, the date in the German document is erroneous but has been kept to correspond to the other phase dates in the German text.
2. Ibid. According to this source, the NKVD did not take over supervision of the prison camps until about the middle of 1943. If true, this was not strictly in accordance with Red Army instructions issued in 1940. Since practically no prisoners taken early in the war survived, information is lacking on camp organization and conditions for this stage of the war.
3. Ibid.
4. MS P-018c
5. USMA, The War in Eastern Europe, Department of Military Art and Engineering (1949), (R), pp. 83, 86.
6. MS P-018c.
7. Interrogations for the purpose of securing evidence against war criminals (which took place largely during Phase V) will

426

SECRET

SECRET

SECRET

SECRET

- be discussed in the subsequent section of this study entitled "Interrogation Methods Applied in Prisoner-of-War Camps."
8. TM 30-430, V - 7ff. It is interesting to note that the Russian word, razvedka, can be translated into English as intelligence (in the military sense), reconnaissance, or observation.
 9. Memo, ACofS, G-2, Hq 12th Army Gp for ACofS, G-2, WD, 6 May 45, sub: Notes on Russian Intelligence (S). Brig. Gen. Edwin L. Siebert, author of this memorandum, had visited with the Chief of Intelligence of the First Ukrainian Army Group on a courtesy visit to that headquarters with Gen. Omar N. Bradley, CG., 12th Army Gp. Following the visit, General Siebert stated, in part: "Prisoner-of-war interrogation is highly organized and is considered the most profitable agency. The gathering of information from ground sources, such as OP's, patrols, etc., is highly rated and highly organized."
 10. MS P-018b.
 11. Ibid. See also DA Pamphlet No. 20-230, pp. 3-7 for a discussion of the characteristics of the Russian soldier.
 12. Survey Sov Int, p. 72.
 13. Interrogation Rpt, dtd 21 Jul 44, in Third Panzer Army G-2 file.
 14. MS P-018b.

427

SECRET

SECRET

SECRET

SECRET

15. DA Pamphlet No. 20-230, pp. 91-92. This monograph contains mention of a number of Soviet atrocities against German prisoners, several of which took place in 1943.
16. See Appendix II, Item 1 of this study; also Appendix VI, Items 8, 9, and 10. Unless otherwise noted, discussion of interrogation procedures practiced in the field are based on MS P-018b.
17. Evidence of the seriousness of this situation can be gathered from an order concerning evacuation procedures issued by the Commissar of Defense in January 1943. See Appendix II, Item 1 of this study.
18. See Appendix VI, Items 6, 9, and 13 of this study.
19. Study, Deutsche Kriegsrefangene in der Sowjet-Union in Anti-Komintern File EAP 116/95.
20. Hq 7707 EUCOM IC, Rpt RT-60-49 (PI-556). This document contains contradictory reports concerning the treatment of prisoners at Stalingrad. Apparently, treatment of prisoners at that time was largely dependent upon individual commanding officers. Large PW units were saved, small units were generally liquidated. Members of SS, Gestapo, tank units, and military police apparently were executed as a matter of principle.
21. Brief summary of Stalin Order No. 171, dtd 8 Jul 43, in Interrogation Reports, Pt. IV, dtd 10 Sep 43; found in Ninth

428

SECRET

SECRET

SECRET

SECRET

- Army G-2 file. The order may have been issued during the Battle of Stalingrad and made public at a later date.
22. Interrogation Rpt, dtd 22 Mar 43, in III Panzer Corps G-2 file.
23. Special order (translation), dtd 7 Jul 44, by HQ 16th Inf Div, found in Third Panzer Army G-2 File. See also Appendix II, Item 2 of this study.
24. See Chapter VI, C, 5 of this study.
25. Former German prisoners have remarked that Soviet interrogators were particularly interested in matters pertaining to German preparations in the field of chemical warfare, the implication being that the Russians expected the Germans to make use of gas. A reference to this effect is found in MS P-018e, Appendix 4.
26. The foregoing discussion concerning evacuation and interrogation procedures practiced during the latter stages of the war has been based largely on MS P-018b. The text differs with this source on one matter, that of the presence of NKVD interrogators at division level. The author believes that German prisoners were subjected to extensive political interrogations at division level by the political commissars and Smersh personnel whom the German prisoners understandably but mistakenly identified as members of the NKVD.

429

SECRET

SECRET

SECRET

SECRET

27. See Appendix VI, Item 12, par. 3 of this study. Note that the first question asked by "political" interrogators (according to this source) was "why are you fighting against a state of workers and farmers?"
28. See Chapter VI, C, 5, a. of this study.
29. OO NKVD and Smersh units conducted essentially the same activities; references in the text to Smersh also apply to OO NKVD.
30. See Chapter VI, C, 5, d. of this study.
31. CIA 00-B-9470, Soviet Intelligence Service: Organization Equipment, Operation (S), 25 Feb 49.
32. Ibid., p. 3.
33. This is an understandable omission for the source, who had applied for U.S. citizenship, would not wish to be associated with any torture methods used by Smersh during the time he had been forced into their service.
34. (1) CIC Doc, Soviet Agents Security, p. 10; (2) Nicola Sinevirsky, Smersh (New York, 1950), pp. 72-77.
35. CIC Doc, Soviet Agents Security, p. 24.
36. Ibid., p. 25. The regulation, issued by GUKR NKO, is quoted in full in this source.
37. Ibid., pp. 25-26. The discussion in the text of Smersh investigation procedures is based almost entirely on this source.

430
SECRET

SECRET

SECRET

SECRET

38. When the Red Army regained Soviet territory, one of Smersh's principal missions was the apprehending of Soviet citizens who had collaborated with the Germans. Information about German atrocities was used after the war in Soviet war-crime trials.
39. CIC, Soviet Agents Security and Counter-Espionage, p. 26.
40. Ibid. Such reprisals were ordered by NKVD Order No. 001552, dated 10 Dec 40.
41. Unless otherwise noted, documents upon which the following discussion of prison-camp conditions is based are as follows: (1) MS P-018b; (2) Team 6, 7020 AF CI Unit, USAFE, Rpt No. 6-137-0250, (s), 8 Feb 50; (3) Team 10, 7020 AF CI Unit, Rpt No. 10-148-0250, (s), 6 Feb 50; (4) Team 12, OSI, IG, USAFE, Rpt No. 12-199-0250, (s), 20 Feb 50; (5) Team 15, 7020 AF CI Unit, USAFE, Rpt No. 15-179-0250, (s), 14 Feb 50; (6) 7001st AISS, USAFE, sub: Soviet Treatment of German PWs, (s), 13 Dec 49; (7) Mil Attache, Belgium, Rpt No. R-171-48, (s), 13 Dec 49; (8) Mil Attache, Iran, Rpt No. R-32-47 (S), Mar 47; (9) U.S. Naval Attache, Moscow, sub: USSR - Construction and Living Conditions, Moscow Area (R), 25 Sep 46, p. 2; (10) BID Doc #331073, sub: Conditions of Release for Officer and Nazi Internees . . . in USSR, Berlin (C), 24 Dec 46; (11) Hq EUCOM IC, Rpt #RT-60-49 (PI-556); (12) 7001 AISS-USAFE, Rpt No. 10-172-1, (s), 10 Jan 50; (13) Hans Rebach, "Gemordet wurde nachts:" (Murders Took Place at Night), Der Spiegel / A German Magazine, 29 May 51.

431
SECRET

SECRET

SECRET

SECRET

42. According to the German authors of MS P-018b, the Red Army operated prisoner-of-war camps until they were taken over by the NKVD in 1943. Since few prisoners were taken prior to that time, practically none of whom survived, the point is both difficult to determine and not too important, but it is the author's opinion that the NKVD operated the camps throughout the war.
43. Hqs USFA, ACoFS, G-2, Special Wkly Rpt No. 7 (TS), 3 Dec 46, Pt. II, p. 15.
44. Hq 7707 EUCOM IC, Rpt #RT-494-50 (CI-096), sub: MVD Prison in Leningrad, 17 May 50 (S), par. 2.
45. MS P-018b. A main camp was designated by number, e.g., Camp No. 724. Its subcamps were designated by another number following the number of the main camp, e.g., Subcamps Nos. 724/1, 724/2.
46. Hq 7707 EUCOM IC, Rpt #RT-60-49 (PI-556), par. 3.
47. See n. 41 (13). This is a magazine article by a former German soldier who had been sent to a Russian penal camp (at Karaganda).
48. See n. 41 (3).
49. OQMG (U.S. Army) provides the following information on bread:
 Russian Rye Bread (Black), Summer 1942... 100 grams - 150 calories
 Russian Rye Bread, Fine (Some Wheat)..... 100 grams - 204 calories

432

SECRET

SECRET

SECRET

SECRET

- Russian Coarse Wheat Bread, After Stalingrad (1943) ...
 100 grams - 217 calories
- U.S. Army Bread, Garrison Loaf (1950) ... 100 grams - 312 calories
- A U.S. Army garrison loaf weighs 20 ounces and contains about 1,684 calories. (One ounce equals 28.3495 grams.) An issue of 300 grams of black bread, or 10.58 ounces, would provide from 450 to 624 calories a day; 600 grams, from 900 to 1,248 calories. The Russians use water and a comparatively high sugar content in making their bread while the U.S. Army uses milk and a lower sugar content.
50. See n. 41 (9), Ch. X. A U.S. Naval Attache in Moscow in 1946 commented that German prisoners he had seen appeared to be more healthy than the average Russian male.
51. See n. 41 (5), par. 2a, and (3), par. 2a, Ch. X.
52. See n. 41 (10), Ch. X. Officers performed lighter tasks, as a rule, such as tailoring.
53. See n. 41 (6), par. 1d, Ch. X.
54. See n. 41 (2), par. c, Ch. X. This report contains the statement "there were very few cases of inadequate medical supplies," and that medical facilities were generally good." This, however, is in sharp contrast to the reports of most repatriates who tell of inadequate supplies and facilities, though they are agreed that the German medics do the best they could with what they had. See n. 41 (12), par. c, Ch. X.

433

SECRET

SECRET

SECRET SECRET

55. See n. 41 (3), par. 2b, and (7), Ch. X.
56. See n. 41 (1), p. 9, and (12), par. g, Ch. X.
57. COMNAVFORGER, at FPO, N.Y. Serial 192-3-47 (S), 30 Apr 47.
(This source covers items a, b, and c.)
58. See n. 41 (8), Ch. X.
59. The Washington Post, October 21, 1950. The death rate in camps for Japanese prisoners was equally bad according to William J. Sebald, Department of State Bulletin, XXII, No. 545 (1950), pp. 24-28. According to Mr. Sebald, a total of 374,041 Japanese had not been repatriated as of the end of 1949; most of these, if not all, was presumed to be dead.
60. See n. 41 (7), (12), Ch. X.
61. See n. 41 (9), Ch. X.
62. MS P-0198e, Appendix 2.
63. MS P-018c. This study consists of a series of papers on the Russian antifa program written by former German prisoners and staff officers under the supervision of the EUCOM Historical Division. Little information has been given in the text concerning the "National Committee for Free Germany," the Paulus Army, or the Von Seydlitz Army. While the "National Committee for Free Germany" was elaborately staged by the Soviets and excited considerable attention at the time, it seems to have

SECRET SECRET

SECRET SECRET

- been nothing more than a part of the Soviet psychological warfare program, and the "movement" was discontinued at the end of the war. No repatriated German who was captured before the end of hostilities was solicited by the Russians to fight against the German Army for the Russians (at least, no repatriate who has been interviewed was solicited), and only a few were accepted by the Soviets to assist in such activities as front-line loudspeaker propaganda broadcasts.
64. MS P-018e, Annex 1 (The Secret of the Power of the Soviet State). The discussion in this reference is not confined to the methods of control of prisoners but extends to all people under Soviet domination.
65. MS P-018c.
66. Ibid.
67. (1) MS P-018b; (2) MS P-018c. Unless otherwise noted, the discussion of the characteristics of the five phases of interrogation is based on these references.
68. During the fourth phase, the NKVD became the MVD, but there was apparently little or no change in the organization so far as the camp-interrogation program was concerned.
69. MS P-018e, Appendix 2.
70. The Main Intelligence Administration of the Red Army (GRU) maintained a staff of at least 350 officers, enlisted men, and civilians during the war as mentioned earlier in this

SECRET SECRET

SECRET SECRET

study. (Chap. VI, C, 3.) It is logical to assume that the NKVD headquarters which directed the prisoner-of-war camp interrogation program was at least as large as the GRU.

71. MS P-018e, Appendix 2. The NKVD and the NKGB, as mentioned before, became the MVD and the MGB, respectively, in 1946. For purposes of convenience, they are referred to in the text by their earlier designations even if, in some instances, the activity discussed took place after 1945.

72. Ibid.

73. Ibid., Section 7.

74. Hans Fritzsche, a prominent Nazi captured at the end of the war, was subjected to such an ordeal, although the object in his case was to secure evidence of war crimes which could be used in the Nuremberg Trials. By the time of the trials, however, he had recovered his physical and mental powers almost completely. Konrad Heiden, "Why They Confess," Life Magazine (June 20, 1949), pp. 92ff. Field Marshal Paulus appeared briefly as a Soviet witness in the Nuremberg Trials but was kept strictly in Soviet custody at all times. According to an observer (Lt. Ernest P. Uiberall, an American interpreter), Paulus was apparently in poor physical condition and seemed to be laboring under great emotional strain, particularly when he attempted to justify his alleged anti-Hitler activities after his capture. Otherwise, he

SECRET SECRET

did not have the manner of one whose mental processes had been permanently impaired. See Trial of the Major War Criminals, VII, pp. 253-61, 279-304. Apparently, there were a number of German officer prisoners led by General von Seydlitz who, after Stalingrad, lost faith in Hitler and voluntarily collaborated with the Soviets but with the idea in mind that they could form an honest alliance with Russia on the basis of an independent Germany free of Nazi domination. Most of these Germans eventually were disillusioned and dropped their activities. They found that they had been playing into Soviet hands while merely attempting to be pro-German and, at the same time, anti-Hitler. It is believed that the Soviets published many pro-Soviet statements credited to prominent German prisoners without the latter's knowledge or consent. See MS P-018c.

75. MS P-018b. Smersh methods of enrolling informers is described in Sinevirsky, Smersh, pp. 106ff.

76. MS P-018c.

77. See Appendix VI, Item 25 of this study. In some cases the questionnaire was not filled out until after the initial interrogation. A new questionnaire was filled out each time a prisoner arrived at a new camp, no matter how many times he was transferred.

78. See Appendix VI, Item 17 of this study.

79. See Appendix VI, Items 14-18, 21, 22, 29, 36, 38 of this study.

SECRET

SECRET

80. See Appendix VI, Items 2, 3, 26, 29, 30, 33 of this study.
81. See Appendix VI, Item 12, par. 3 of this study.
82. (1) "The Technique of Soviet Interrogation," Monthly Intelligence Report (British Armed Forces Magazine) (S) (June 1949), p. 39; (2) USFA Special Biweekly Rpt No. 100, 16 Sep 49, Pt. II, Hungary (S), pp. 15ff.
83. (1) MS P-018b; (2) MS P-018e, Appendix 2.
84. MS P-018b.
85. MS P-018b. The use of information on file to verify prisoner-of-war information is not unique to Soviet methods. Military intelligence interrogators of all armies use similar procedures.
86. MS P-018e, Appendix 4.
87. MS P-018b.
88. Information is lacking on Soviet methods of indexing and cross-indexing individual prisoner record cards. It is possible that machine-record methods were used in higher headquarters, but no references to such mechanical devices have been uncovered during research for this study.
89. MS P-018b.
90. In addition to the special camps mentioned previously in the text, certain highly specialized army and naval officers were sent to a camp at Kochevo which was reputed to be an "extermination"

438
SECRET

SECRET

SECRET

SECRET

- camp. Prisoners in this camp were carefully interrogated on their specialties, and the methods used were said to be especially harsh. Scientists, including nuclear physicists, were sent to a camp at Krasnogorsk. All specialists in this camp were compelled to write all they know about their special fields; the amount of food each prisoner received was determined by the value of his written report. A large number of German generals (approximately eighty) were also held at Krasnogorsk for interrogation. See, OI Special Triangle Rpt 39, HQ 7707 EUCOM IC, 8 Sep 47 (TS).
91. Soviet interrogators were particularly careful when dealing with prominent political personalities such as Cardinal Mindszenty (Stephen K. Swift, "How They Broke Cardinal Mindszenty," Reader's Digest (November 1949), pp. 1ff). See also Appendix VI, Item 33 of this study and MS P-018b.
92. CIA, Info Rpt No. 30, DB-19054, Soviet Methods in the Interrogation of Prisoners of War, 30 Oct 49 (S), par. 15.
93. Monthly Int Rpt (English), Jun 49, The Technique of Soviet Interrogation, pp. 35-43. This is an excellent discussion of Soviet "purge trial" methods.
94. MS P-018b. See also Appendix VI, Items 16, 22, 23, 24 of this study.
95. MS P-018b.

439
SECRET

SECRET

SECRET

SECRET

96. Hans Fritzsche spent his first several weeks in Lubianka Prison in a "standing-coffin" three feet square according to the previously quoted article in Life Magazine. His stay in the cell was broken only by trips to the interrogation chamber and the latrine.
97. (1) MS P-018b; (2) Hq 7707 EUCOM IC, Rpt No. RT-494-50 (CI-986), MVD Prison in Leningrad, 17 May 50 (S), par. 2. (Paragraph 3 of this report is reproduced in Appendix VI, Item 14 of this study.) Some of these precautions have been observed in Allied prisons to prevent any danger of the prisoner committing suicide.
98. USFA Special Biweekly Rpt No. 100, 16 Sep 49 (S), Pt. II, p. 17.
99. MS P-018b.
100. Few prisoners of war were subjected to public trials, such procedures more ordinarily being reserved for political scapegoats of the Soviets both in Russia and its satellite states. The scope of this study does not permit an extended treatment of Soviet methods of interrogating Soviet citizens or citizens of satellite states. An excellent, short treatment of this subject may be found in the CIC study, Guide for Intelligence Interrogators of Eastern Cases, Hq 7707 EUCOM IC, Apr 48 (S), pp. 36ff. See also an aforementioned article in a British military publication (Monthly Intelligence Report, June 1949),

440
SECRET

SECRET

SECRET

SECRET

- and Stephen K. Swift, The Cardinal's Story (New York, 1949), an expose of Cardinal Mindszenty's interrogation, a condensation of which appeared in Readers Digest, Nov 49. An emotional, highly colored account of Smerish methods of interrogating citizens of Soviet-occupied countries may be found in Sinevirsky, Smerish, Ch. V through XV. See also, Zbigniew Stypulkowski, "Behind the Iron Shutters of Lubianka," New York Times Magazine, May 20, 1951, p. 15. This excellent article on interrogation procedures in Lubianka prison is based on excerpts from a book by the same author, Invitation to Moscow (London, 1951).
101. See the previously cited article in the British Monthly Intelligence Report, June 49, for example of Soviet purge-trial proceedings and techniques.
102. (1) See Appendix VI, Item 41 of this study; (2) Appendix VI, Item 26; (3) Appendix VI, Item 34; (4) Swift, "How They Broke Cardinal Mindszenty," pp. 1ff.
103. See n. 102, (2), Ch. X. In this report the drug is referred to as Chlorine Hydrate, but this could well be an error on the part of a translator.
104. For a complete description of the clinical use and effects of chloral hydrate, see Goodman and Gilman, The Pharmacological Basis of Therapeutics (New York, 1941), pp. 175-78. Any standard work on pharmacology will carry a similar description of the drug.

441
SECRET

SECRET

SECRET

SECRET

105. According to a pharmacologist of the Pure Food and Drug Section, U.S. Department of Justice, actedron is not listed in any current codex, either American or foreign (May 1950). From a description of its effect on the human nervous system, it may be that it is one of the alkaloids of the belladonna plants, the two most important of which are atrophine and scopolamine. Atrophine first stimulates then depresses the brain. Scopolamine, an ingredient of the anesthesia known as "twilight sleep," is a repressant and normally causes drowsiness, fatigue, and dreamless sleep. It may be, however, that actedron contains mescaline, a derivative of the dumpling cactus (Laphophora williamsi), which produces strange psychic effects and hallucinations. See Goodman and Gilman, The Pharmacological Basis of Therapeutics, pp. 48, 436, 460, and 575.
106. See n. 102 (4), Ch. X.
107. See n. 102 (1), Ch. X.
108. Goodman and Gilman, The Pharmacological Basis of Therapeutics, p. 48.
109. Ibid., p. 575.
110. G. T. Stockings, "A Clinical Study of the Mescaline Psychosis, With Special Reference to the Genesis of Schizophrenic and Other Psychotic States," Journal of Medical Science LXXVI (1940), pp. 29-47. See also, E. F. Castetter and M. E. Opler,

442
SECRET

SECRET

SECRET

SECRET

- "Plants Used by the Mexcalero and Chiricaluna Apache for Food, Drink, and Narcotics," University of New Mexico Bulletin (Biol. Ser.) IV (1936), pp. 35ff. These two papers seem to be the only studies of the effects of mescaline on the nervous system published in the United States, beyond, of course, short comments in standard works on pharmacology.
111. Information obtained from Lt. Col. Stephen W. Ranson, AMC, of the Psychiatry and Neurology Consultants Division, Surgeon General's Office (May 1950).
112. MS P-018e, Appendix 2. See also Appendix VI, Items 16, 20, 21, 22, 23 of this study.
113. Annex to Rpt, dtd 6 Feb 50, in MS D-387. This MS, as well as MS D-388, constitutes a collection of studies, reports, letters, and appeals pertaining to the interrogation, trial, and treatment of German PW's in Russia during the post-war period, in documentation of the MS P-018 series.
114. Declaration on German Atrocities [Moscow Declaration], released 1 Nov 43. The Text of this document may be found in Trials of the War Criminals Before the Nuernberg Military Tribunals (Washington, 1950), IV, 1950-872486.
115. Ltr, dtd 21 Feb 50, in MS D-387.
116. Rpt, dtd 31 Jan 50, in MS D-387. The Soviets made special efforts to discover former members of the Viking and Brandenburg Divisions against whom they particularly desired to wreak their

443
SECRET

SECRET

SECRET

SECRET

vengeance. The Viking Division (5th SS Panzer Division) had participated in the initial invasion of Russia and had been particularly troublesome to the Red Army in 1944 at Korsun and in Poland. The Brandenburg Division was a specially trained sabotage unit which came under direct control of the Sabotage Section OKW Abwehr II. Abwehr II was the department of the German Military Intelligence Service which was concerned with sabotage. Its functions were later taken over by the SD (Security Service) and the MI Bureau of the RSHA (Reichsicherheitshauptamt - Reich Security Main Office). See Order of Battle of the German Army, MID, WD, 1 Mar 45 (R), pp. 312, 330.

117. Ibid. It should be noted that many members of the Wehrmacht who had never been in Russia during the war were "captured" by the Red Army after Germany's capitulation and sent to prisoner-of-war camps in Russia. Many Germans who had been held captive by the western powers and who were repatriated to eastern Germany after the war were also sent to Soviet prison camps.

118. Ibid. This report contains an appeal to the Federate Govt. at Bonn.

119. The Soviets probably included in this category Germans who had any part in enforcing military law in Soviet territory occupied by the Germans.

120. MS P-018e. See also Appendix VI, Item 22 of this study.

444

SECRET

SECRET

SECRET

SECRET

121. MS D-387 contains an appeal to the Federate Govt. at Bonn.
122. MS P-018e, Appendices 2 and 6.
123. See Appendix VI, Item 23 of this study.
124. Rpt, dtd 15 Feb 50, in MS D-387.
125. See Appendix VI, Item 18 of this study.
126. MS P-018e, Appendix 6.
127. Rpt, dtd 31 Jan 50, and excerpt from Ltr, dtd 11 Feb 50, in MS D-387. Descriptions of the arrest and trial procedure may be found in these sources.
128. Ltr, dtd 21 Feb 50, in MS D-387. An account of life in a typical penal camp to which war criminals were sent may be found in Rebach, Gemordet wurde Nachts, p. 10.

445

SECRET

SECRET

SECRET

SECRET

Chapter XI

1. GHQ, FEC, MIS, ATIS Interrogation Report No. 60, 29 Oct 48 (S), pp. 38, 47. This report, compiled from interrogations of thousands of Japanese repatriated from the USSR, gives a comprehensive picture of the conditions in the Soviet PW camps for Japanese, the indoctrination program, and the organization of the camps.
2. As late as 7 Dec 50, the Russians served notice to the United Nations at Lake Success that they would block any attempt to make an inquiry into the fate of German and Japanese prisoners believed still held in the USSR. On that date, British Commonwealth delegates to the United Nations stated in debates on the subject that an estimated 62,792 Germans and 369,382 Japanese prisoners in the USSR were unaccounted for. Other sources reveal similar figures. See: (1) Washington Post, December 7, 1950 (AP dispatch from Lake Success); (2) ATIS Interrog Rpt 60, p. 47; (3) Robert A. Fearey, The Occupation of Japan, Second Phase: 1948-1950 (New York, 1950), pp. 14-17; (4) Wm. J. Sebald, "Soviet Union Still Refuses to Cooperate in Repatriation of Japanese," Dept of State Bul., XXII, No. 548 (1950), pp. 24-28.
3. See n. 2 (3) and (4), Ch. XI.
4. ATIS Rpt No. 60, pp. 38ff.
5. Ibid., p. 2.

446

SECRET

SECRET

SECRET

SECRET

6. Ibid. This ATIS report contains lists and numbers of the known districts and camps, a description of the name and number system used by the Soviets, and maps showing the locations of all known camps.
7. Ibid., p. 4.
8. See n. 2 (4), Ch. XI.
9. ATIS Rpt No. 60, pp. 31-37.
10. Ibid., pp. iii, 5-10.
11. Ibid., pp. 11-15.
12. Ibid., pp. 15-37.
13. (1) T-1, G-2, GHQ, FEC, Rpt No. TB-2384-4578, 1 Oct 49 (g), (see Appendix VIII, Item 1 of this study); (2) T/I, G-2, GHQ, FEC, Rpt No. TB-47-50, 18 Jan 50 (S) (See appendix VIII, Items 2-19 of this study.
14. See Appendix VIII, Items 1, 5, 7, 11, 12, and 18 of this study.
15. See n. 13 (2), Ch. XI, p. 13.
16. See Appendix VIII, Items 11, 12, 19 of this study.
17. See Appendix VIII, Item 1 of this study
18. See n. 13 (2), Ch. XI, p. 10.
19. See n. 13 (2), Ch. XI, pp. 9, 13. For locations of Khabarovsk and Nakhodka, see ATIS Interrog Rpt 60, Plate 1 (map).
20. (1) See Appendix VIII, Item 1 of this study; (2) See n. 13, Ch. XI, p. 22.
21. (1) See Appendix VIII, Items 8, 19 of this study; (2) see n. 13, Ch. XI, p. 12.
22. (1) See Appendix VIII, Items 1, 3, 6-9, 12, 13, 15, 19 of this study.

117

SECRET

SECRET

SECRET

Chapter XII

1. Geneva Conventions of August 12, 1949 For the Protection of War Victims (Dept. of State, Publication 3938, General Foreign Policy Series 34 [August 1950]), p. 118.
2. Ibid., p. 235. As of September 1951, no major powers, including the USSR and the United States, had officially ratified this convention.

448

SECRET

SECRET

SECRET

SECRET

GLOSSARY

Soviet terms and alphabetical designations of Soviet organizations used in the text of the study.

-
- Cheka (Chrizvechaninaya Komisiya) Extraordinary Commission for Combating Counter-revolution, Speculation, and Sabotage. First Soviet surveillance agency, founded in June 1918.
- GB (Gossudarstvennoi Bezopasnosti) State Security. These initials accompanied the rank designation of political career officers of the OO NKVD and GUKR NKO Smersh.
- GPU (Gosudarstvennoye Politicheskoye Upravleniye) Political Directorate; successor to the Cheka in 1922.
- GRU (Glavnoye Razvedivatelnoye Upravleniye) Main Intelligence Directorate of the War Ministry.
- GUGB (Glavnoye Upravleniye Gosudarstvennoi Bezopasnosti) Main Directorate for State Security.
- GUKR (Glavnoye Upravleniye Kontrrazvedki) Main Directorate of Counterintelligence of the NKO. Successor to the OO NKVD in 1943. Often referred to during World War II as Smersh.
- GUP Voisk MVD.... (Glavnoye Upravleniye Pogranichnikh Voisk MVD) Main Directorate of Frontier Troops, MVD.
- GUPVI (Glavnoye Upravleniye Po Dolam Voivonoplennvkh I Internirovaniy) Main Directorate of the Affairs of Prisoners of War and Internees.
- KRU (Kontrrazvedyvatelnoye Upravleniye) Administration and Counter-Espionage Section of the GUGB. Performed intelligence duties in non-military sectors.
- MCB (Ministerstvo Gosudarstvennoi Bezopasnosti) Ministry of State Security. Successor to the NKGB in 1946.

449

SECRET

SECRET

SECRET

SECRET

MVD (Ministerstvo Vnutrennikh Del) Ministry of the Interior.
Successor to the NKVD in 1946.

MVS (Ministerstvo Vooruzhennikh Svl) Ministry of the Armed
Forces. Combination of and successor to NKO and NKVMF
in 1946.

Nachalnik Lagera..Camp Commander of a prisoner-of-war camp.

NKO (Narodny Kommissariat Oborony) Peoples' Commissariat
for National Defense.

NKGB (Narodny Kommissariat Gosudarstvennoi Bezopasnosti)
Peoples' Commissariat of State Security.

NKVD (Narodny Kommissariat Vnutrennikh Del) Peoples'
Commissariat of Internal Affairs.

OGPU (Obvedinennoye Gosudarstvennoye Politicheskoye Upravleniye)
United State Political Directorate. Successor to the
GPU in 1923.

OKR NKO Smersh... (Otdel Kontrrazvedki NKO Smert Shpionam) Agencies of
GUKR NKO in lower echelons of the armed forces. Smersh
is a contraction of Smert Shpionam which means "Death
to the Spies," and was the popular nickname for the
organization.

OO NKVD (Gsobri Otdel NKVD) Military surveillance units of the
NKVD. Succeeded by GUKR NKO Smersh.

OP (Oblastnoye Pravlenie) District Administration for
Escort and Convoy Troops.

OPVI (Oblastnoye Pravlenie Voiyennoplenennykh I Internirovanvi)
District Administration for Affairs of Prisoners and
Internees.

PMSch 2 (Pomoshnik Nachalnika Shtaba 2) Second assistant to the
chief of the regimental staff. (Intelligence or recon-
naissance officer in lower echelon headquarters.)

RO (Razvedyvatelni Otdel) Intelligence Staff Section of
an Army, Corps, or Division.

450

SECRET

SECRET

SECRET

SECRET

RU (Razvedyvatelnoye Upravleniye) Intelligence Directorate
of Front (Army Group) or Military District Headquarters.

Smersh See OKR NKO Smersh.

Shtab Staff of a Red Army Headquarters. (Often used as a
general term for any military headquarters.)

VO GPU (Voiyenny Otdel GPU) Military surveillance section of
the GPU. Preceded the OO NKVD.

451

SECRET

SECRET

Val II
847118 **SECRET**
Security Information

847118
RUSSIAN METHODS OF **INTERROGATING** R
CAPTURED PERSONNEL
WORLD WAR II

VOLUME II : APPENDIXES

By
KERMIT G. STEWART
Major, Infantry, United States Army

FILE COPY
MUST BE FORWARDED TO
OFFICE OF THE CHIEF OF MILITARY HISTORY DOCUMENT FILE SECTION
DEPARTMENT OF THE ARMY G-2, U. S. ARMY
WITHIN TWO WEEKS

00935
Hq 9C2d CIC Det
Log S-15473-1

SECRET
Security Information

SECRET

GENERAL SERVICES ADMINISTRATION
FEDERAL RECORDS CENTER
REGION 3



MILITARY RECORDS BRANCH

B11248

SECRET

SECRET SECURITY INFORMATION

RUSSIAN METHODS

OF

INTERROGATING CAPTURED PERSONNEL

WORLD WAR II

Volume II: Appendixes

by

Hermit G. Stewart

Major, CSC (Inf)

W A R N I N G

This document contains information affecting the national defense of the United States within the meaning of the Espionage Act, 50 U. S. C. 31 and 32, as amended. Its transmission, or the revelation of its contents in any manner, to an unauthorized person is prohibited by law. It is imperative that this document be safeguarded at all times, and that the material contained in it be treated with the utmost discretion. Under no circumstances shall possession thereof, or the information therein, be given to any personnel other than those whose duties specifically require knowledge thereof. When not in use, this document is chargeable to the custody of an officer. See pars 12, 15, 26, 31, 33, AR 380-5, 15 August 1946.

Office of the Chief of Military History

Department of the Army

1952

SECRET SECURITY INFORMATION

SECRET SECURITY INFORMATION

RUSSIAN METHODS

746372

OF

INTERROGATING CAPTURED PERSONNEL

WORLD WAR II

Volume II: Appendixes

by

Kermit G. Stewart

Major, CSC (Inf)

W A R N I N G

This document contains information affecting the national defense of the United States within the meaning of the Espionage Act, 50 U. S. C. 31 and 32, as amended. Its transmission, or the revelation of its contents in any manner, to an unauthorized person is prohibited by law. It is imperative that this document be safeguarded at all times, and that the material contained in it be treated with the utmost discretion. Under no circumstances shall possession thereof, or the information therein, be given to any personnel other than those whose duties specifically require knowledge thereof. When not in use, this document is chargeable to the custody of an officer. See pars 12, 15, 26, 31, 33, AR 380-5, 15 August 1946.

Office of the Chief of Military History

Department of the Army

1952

SECRET SECURITY INFORMATION

SECRET SECURITY INFORMATION

CONTENTS

	Page
Appendix I Soviet Interrogation Report Forms	1
Appendix II Soviet Evacuation Orders	6
Appendix III Guide for the Political Interrogation of Prisoners of War -- Directive Concerning the Political Questioning of German Prisoners	13
Appendix IV Directives for the Interrogation of PW's by Reconnaissance Officers of the Red Army	26
Appendix V Military Institute of Foreign Languages in Moscow	29
Appendix VI Documentary Excerpts: Soviet Methods of Interrogation (41 Items)	47
Appendix VII Red Army Interrogation Forms	132
Appendix VIII Documentary Excerpts: Soviet Methods of Interrogating Japanese Prisoners of War	137
Appendix IX Documentary Excerpts: North Korean Interrogation Methods	155

SECRET SECURITY INFORMATION
APPENDIX I*

SOVIET ARMY

Form for Report on Prisoners Captured by Reconnaissance Units, Rifle Companies, and Battalions.

Note: The following questions were printed on a form with appropriate blank spaces for filling in answers.

To _____
From _____
No. _____ Time of departure _____
Map _____ Edition _____ Year _____

A. For Individual Prisoners (when there is enough time)

1. Last name, first name, rank, and duty _____
2. Subsection, unit, branch of service _____
3. Time of capture _____
4. Circumstance of capture _____
5. Outstanding data (briefly) _____
6. Accompanying documents _____

Signature _____
Receipt of the consignee: No. _____ Time of receipt _____
Place _____ Number of prisoners and a list of documents taken from them _____

B. For a Large Number of Prisoners (when time is limited)

Subsection _____ Unit _____ Officers _____ NCOs _____ Soldiers _____
Place and time of capture _____

More important testimony of individual prisoners (They are interrogated only briefly and if time permits) _____
Accompanying documents _____

Receipt of the consignee: No. _____ Time _____ Place _____ Number of prisoners _____ List of documents _____

* Reference: CIA Document OO-W-1009 (C), p. 17.

SECRET SECURITY INFORMATIONForm for Interrogation of Prisoners at Regimental Level
During Offensive Operations

[Note: The following questions were printed on a form with appropriate blank spaces for filling in answers. This was not a fixed pattern.]

Interrogation Sheet

HQ _____ Rifle Regiment _____ 194_____
Map _____ Edition _____

1. Last, first, middle name of prisoner. Social status, place of birth, duty, rank or rating, age, nationality, conscripted or enlisted, when and where captured.
 2. To what unit did prisoner (deserter) belong? (In questioning, try to establish the highest military unit of which the prisoner has knowledge.)
 3. Where did the unit come from? What is its disposition, composition, and mission?
 4. Location of Headquarters.
 5. Names and ranks of immediate superiors and their characteristics.
 6. What are the neighboring units: location, numbers, missions, locations of reserves?
 7. Where is the front line defense, barbed wire (how many rows), mine fields, land mines? Are there concrete fortifications and where are they? Antitank guns, machine guns, mortars? How long did it take to build the defense? Depth of trenches? Are there any defenses in depth?
 8. How many and where are the tanks, artillery, and other technical equipment? Calibers and other technical information.
 9. To what locality are they ordered to retreat? What are the losses? Who orders the retreat? Whereabouts of tanks and artillery? Are reserves arriving? From where? What is their composition?
- (Note: These questions are asked when fighting within enemy defenses.)
10. Adequacy of unit's supply, food situation, equipment, clothing.
 11. What is the morale of the soldiers? What is the trend of conversation on recent battles?
 12. Morale of local inhabitants.
 13. Additional questions.
 14. Grade of reliability of information.

Interrogated _____

The following documents were taken from the prisoner: _____

SECRET SECURITY INFORMATION**SECRET SECURITY INFORMATION**Form for Interrogation of Prisoners at Regimental Level
During a Defensive Operation

[Note: The following questions were printed on a form with appropriate blank spaces for filling in answers. This was not a fixed pattern.]

Interrogation Sheet

HQ _____ Rifle Regiment _____ Date _____ 194_____
Map _____ Edition _____

1. Last, first, middle name of prisoner. Social status, place of birth, duty, rank or rating, age, nationality, conscripted or enlisted, when and where captured.
2. To what unit did prisoner (deserter) belong?
3. Where did the unit come from? What is its disposition, composition, and mission?
4. Location of Headquarters.
5. Names and ranks of immediate superiors and their characteristics.
6. What are the neighboring units: location, numbers, missions, locations of reserves?
7. Location and quantity of: machine guns, mortars, tanks (particularly), antitank and infantry artillery, observation and command posts, reserves.
8. Location and quantity of: artillery, artillery units, motorized units, new means of warfare.
9. Unit losses and adequacy of supplies, food situation, equipment, clothing.
10. What is the morale of the soldiers? What is the trend of conversation on recent battles?
11. Additional questions.
12. Grade of reliability of information.

Interrogated _____

The following documents were taken from the prisoner: _____

SECRET SECURITY INFORMATION

SECRET SECURITY INFORMATION

Form for Interrogation of Prisoners at Division Level
During Offensive Operations

Note: The following questions were printed on a form with appropriate blank spaces for filling in answers. This was not a fixed pattern.

Interrogation Sheet
HQ _____ Division _____ Date 194____
Map _____ Edition _____

1. Last, first, middle name of prisoner. Social status, place of birth, duty, rank or rating, age, nationality, conscripted or enlisted, when and where captured. Occupation before military service. Date prisoner joined this unit and his assignments. Where and when taken prisoner.
2. To what regiment, division, and corps did the prisoner belong? Ranks and names of commanders of those units as well as those of the chiefs of staff. Is his unit temporarily or permanently assigned to this command?
3. Location of Headquarters and command posts (note on map).
4. Neighboring units on the right and left; their missions.
5. Missions of the unit and division. Arrived from where? Replaced what units?
6. Where is the front line of defense, barbed wire, mine fields, land mines? Are there concrete fortifications and where are they? Antitank guns, machine guns, mortars? How long did it take to build the defenses? Depth of trenches? Are there any defenses in depth?
7. Location and disposition of artillery, tanks, chemical units. any air force? Other technical weapons?
8. Arrival of new units: kind, time of arrival, strength, place of departure and destination, number, where from.
9. What units along the route of the prisoner?
10. Location of rear installations.
11. Fighting qualities of the unit. Losses in the last battles.
12. What replacements have arrived recently? How often, when, and from where?
13. Additional questions.
14. Conclusion: Grade of reliability of answers given by the prisoner, depending on his class standing, nationality, and condition (degree of fatigue and depression).

Interrogated _____ Date 194____
The following documents were taken from the prisoner _____

SECRET SECURITY INFORMATION

Appendix I
Form 4

SECRET SECURITY INFORMATION

Form for Interrogation of Prisoners at Division Level
During Defensive Operations

Note: The following questions were printed on a form with appropriate blank spaces for filling in answers. This was not a fixed pattern.

Interrogation Sheet
HQ _____ Division _____ Date 194____
Map _____ Edition _____

1. Last, first, middle name of prisoner. Social status, place of birth, duty, rank or rating, age, nationality, conscripted or enlisted, when and where captured. Occupation before military service. Date prisoner joined this unit and his assignments. Where and when taken prisoner.
2. To what regiment, division, and corps did the prisoner belong? Ranks and names of commanders of those units as well as those of the chiefs of staff. Is his unit temporarily or permanently assigned to this command?
3. Location of Headquarters and command posts (note on map).
4. Neighboring units on the right and left: their missions.
5. Missions of the unit and division. Arrived from where? Replaced what units?
6. How many and what units comprise the first echelon? Type and quantity of ranks, artillery, chemical units, and other technical equipment. Location of the main concentration of troops, reserves and support units, motorized units, cavalry.
7. Arrival and new units: kind, time of arrival, strength, place of departure and destination, number, where from.
8. What units along the route of the prisoner?
9. Amount of losses. Soldiers' morale.
10. Adequacy of supply of a unit. Food situation. Disposition and kind of rear installations.
11. What replacements arrived recently?
12. Additional questions.
13. Conclusion: Degree of reliability of prisoner's information.

Interrogated _____ Date 194____
The following documents are forwarded _____

Appendix I
Form 5

SECRET SECURITY INFORMATION

SECRET SECURITY INFORMATION
APPENDIX II*
Item 1

SOVIET EVACUATION ORDERS

[Note: This document is an English translation of a German translation of a Russian order. Since the original Russian document is not available, direct quotations from the German document are included in brackets when the meaning is in question.]

Order of the Peoples' Commissariat for the Defense of the USSR
2 January 1943 No. 001 Moscow

SUBJECT: Procedure for Evacuating Prisoners of War from the Frontlines

A number of serious defects have been observed in the evacuation and protection of prisoners of war at the front and enroute to the reception camp:

1. Prisoners of war are retained too long by units of the Red Army. From the moment of capture to the time of entraining, prisoners have to cover from 200 to 300 kilometers on foot. Frequently, they do not receive rations of any kind. As a result, they arrive sick and in a state of considerable exhaustion.
2. A large number of prisoners do not have any warm clothing of their own. Contrary to (my) orders, they are not issued clothing from captured stocks.
3. Prisoners marching from the place of capture to the entraining point are often guarded by too small a number of soldiers or not at all. As a result, they lose themselves among the civilian population.
4. By order of the Army Rear Area Headquarters of the Red Army [Stab des ruckwaertigen Heeresgebietes der Roten Armees] and the Red Army Main Directorate for Ration Supply [Hauptverwaltung des Proviantnachschubes der Roten Armees] the prisoner of war reception camps and assembly points of the NKVD are to be furnished with

*Source: German PW Survey Foreign Armies East [H/3/682] has been translated for this appendix rather than the less complete German version cited in note 25, Chapter VII: Study Deutsche Kriegsgefangene in der Sowjetunion, in Anti-Komintern File EAP 116/95.

SECRET SECURITY INFORMATION

SECRET SECURITY INFORMATION

rations and transportation by the army groups. They are, however, supplied only to such a limited extent that not even the minimum requirements are satisfied.

5. The Army Transportation Inspectorates [Heeresverkehrsin-spektion] with the army groups do not furnish rolling stock in time and in sufficient numbers for purposes of evacuating prisoners of war to rear-area camps; furthermore, such rolling stock as has been made available is totally unsuitable for the transport of human beings, since it contains neither cots nor stoves, washbasins, wood, and housekeeping equipment.

6. Contrary to the directive on prisoners of war approved by the Commissariat of [Public] Health in the USSR [Kommissariat fuer das Gesundheitswesen in der UdSSR] and contrary to the directive issued by the Chief of the Army Medical Service, wounded and sick prisoners of war are not admitted to the field hospitals, but shipped through regular channels to the reception camps and NKVD camps. As a result, a great many prisoners die of exhaustion prior to evacuation to the rear or enroute to the rear.

In order to eliminate such defects in the care of prisoners of war once and for all and to preserve them as a source of labor, Commanding Generals of the Army Groups will carry out the following orders:

1. Secure the prompt evacuation of prisoners of war to assembly points. In order to expedite the evacuation, all transportation returning empty from the front is to be utilized.
2. Instruct unit commanders to issue rations to prisoners of war in transit prior to their transfer to an NKVD Camp in accordance with allowances established by the Commissariat of [Public] Health in the USSR in [Directive] No. 1874/874c. Prisoner of war shipments are to be furnished field kitchens from captured stocks and transportation needed for the hauling of rations.
3. Render prompt medical aid to sick or wounded prisoners of war in accordance with prisoner of war regulation, Directive of the Commissariat of [Public] Health in the USSR No. 1798/300c, dated 5 July 1941.

Do not evacuate sick, wounded, completely exhausted, and frostbitten prisoners through regular channels to NKVD assembly points. Such prisoners are to be admitted to a [field] hospital and evacuated with the next shipment [of sick and wounded] to the rear for specialist treatment. They will receive rations in accordance with allowances established for sick prisoners of war.

SECRET SECURITY INFORMATION

SECRET SECURITY INFORMATION

4. Provide sufficient escort personnel for the evacuation of prisoners of war from the place of capture to the reception camps of the NKVD.

5. Locate the prisoner of war entraining points as close as possible to assembly points so as to avoid long marches on foot.

6. Give a shipping list to the men in charge of the shipment. This roster should list the number of prisoners of war, the rations issued to the prisoners, equipment supplied for the shipment, and the means of transportation. The prisoner of war roster must be produced at the time the prisoners are turned over to the reception camp. The men in charge of the shipment are to be instructed to list all documents which were taken from the prisoners in order to transmit them to the reception camp.

7. Limit the daily rate of march to 25-30 kilometers. After each 26-30 kilometers, rest stations should be established where prisoners can spend the night. At these stations, prisoners should be provided with hot food and hot water and given an opportunity to warm themselves.

8. Prisoners of war will be permitted to keep [outer] clothing, shoes, underwear, bedding, and mess gear. If prisoners lack warm clothing, shoes, and mess gear of their own, such articles must be supplied from captured stocks and from the property of killed and deceased enemy officers and enlisted men.

9. Commanding Generals of Army Groups and Military Districts will carry out the following orders:

a. Check immediately, in accordance with Directive No. 24/103892, dated 30 November 1942, of the Rear Area Main Directorate of the Red Army [Stab der obersten Verwaltung im ruckwaertigen Gebiet der Roten Armee] and with Directive No. 3911/III, dated 10 December 1942, of the Red Army Main Directorate for Ration Supply [Stab der Obersten Verwaltung fuer den Verpflegungsnachschub der Roten Armee], to see that NKVD reception camps and transient camps are properly supplied with rations. Rations should be stockpiled at assembly points and transient camps in order to assure uniform distribution of food to prisoners of war.

b. Furnish the reception and transient camps of the NKVD with sufficient transportation and housekeeping equipment. In case of a very heavy flow of prisoners, additional transportation and housekeeping equipment should be issued to assembly points and camps.

Appendix II
Item 1

SECRET SECURITY INFORMATION**SECRET SECURITY INFORMATION**

10. The Chief of the Red Army Transportation Inspectorate [Chef der Heeresverkehrsinspektion der Roten Armee] will carry out the following orders:

a. Make available the requisite number of [railroad] cars for immediate transport of prisoners of war to camps; equip the cars with cots, stoves, and wash basins; provide for uniform heating along the route of travel; utilize units which are drawn from combat troops for transporting prisoners of war to the rear.

b. Assure the rapid movement of these units as troop transports.

c. At the Red Army Transportation Inspectorate, establish a movement control agency which will supervise the movement of units escorting prisoners of war.

d. Limit the load of prisoners of war per [railroad] car so that 44 - 50 men are allocated to a two-axle car and 80 - 90 men to a four-axle car. Prisoner of war shipments should be made up of no more than 1,500 men.

e. Provide warm meals regularly for the prisoners of war and supplement travel rations at all ration points and messing establishments in accordance with ration vouchers which have been issued by army units, reception points, and NKVD camps.

f. Provide an adequate supply of drinking water for the prisoners and see to it that three pails are placed in each two-axle car and five pails in each four-axle car.

11. The Chief of the Red Army Medical service will carry out the following orders:

a. Assure the medical treatment of sick, wounded, frostbitten, and greatly exhausted prisoners of war in the Red Army medical installations at and near the front.

b. Organize their prompt evacuation to hospitals in the rear for specialist treatment.

c. Detail the requisite medical personnel, with adequate medical supplies, to minister to the prisoners of war while in transit. Medical personnel from among the prisoners is also to be utilized for such duties.

Appendix II
Item 1

SECRET SECURITY INFORMATION

SECRET SECURITY INFORMATION

d. Screen and check prisoner-of-war transports in transit at the points of evacuation and furnish medical aid to the sick. Prisoners whose states of health do not permit resumption of travel are to be taken off the shipment, admitted to the nearest hospital, and, at the earliest opportunity, evacuated to a hospital in the rear for specialist treatment.

e. Exercise hygienic care of the prisoners of war by disinfecting their personal belongings while in transit.

f. Take measures to prevent epidemics among the prisoners of war until such time that they are turned over to the NKVD camp.

12. Prohibit the shipment of prisoners of war in railroad cars which are not heated and unfit for the transport of human beings and which do not carry an adequate supply of wood, travel rations, and housekeeping equipment. See to it, moreover, that prisoners are not shipped without seasonal clothing and shoes.

13. Transmit this order by teletype.

By Order [of the Peoples' Commissariat for the Defense of the USSR]

The Deputy Peoples' Commissar for Defense

General [Generaloberst-Intendant]

A. Churiliev

"A True Copy" B.O. 18th S.G. Corps
Technician 2d Grade Gerasimow

"A True Copy of the Copy"
Chief of the Secret Section 1st Lt. Babik
(signature)

Appendix II
Item 1

SECRET SECURITY INFORMATION**SECRET SECURITY INFORMATION**

APPENDIX II*
Item 2

RED ARMY ORDER:
PROCESSING OF PRISONERS

Annex 1 to HQ Third Panzer Army, 1c/AO**
(Translation Sub-Section) Report/
No. 0950/44, Confidential, dtd 24 Aug 44

Translation

Infantry Regiment 156

Strictly Confidential
No. 0023

Order by HQ 16th Division 1700 hours

7 July 1944

To this date, violations of order 001, issued in 1943 by the Peoples' Commissariat for the Defense of the USSR, still occur among the troop units of the division. As a rule, prisoners are held too long at the regimental headquarters, and, as a result, information obtained from the enemy loses its value.

There have also been additional instances of depriving prisoners, in contravention of orders, of valuables, clothing, and footwear (156th Infantry Regiment).

The Division Commander has issued orders [as follows]:

1. After a tentative interrogation, all prisoners, accompanied by a copy of the interrogation report, will be turned over to the 2d [Staff] Section of Division HQ. Prisoners who can reveal important information about the enemy will be sent on immediately after the interrogation.
2. The stealing of the prisoners' personal belongings, their valuables, clothing, and footwear, is to be categorically prohibited.
3. The use of scouts as guard-escort personnel for prisoners is to be discontinued.

Chief of Staff
Colonel

Signature (Urbschas)

Appendix II
Item 2

SECRET SECURITY INFORMATION

SECRET SECURITY INFORMATION

Ic
Major

Signature (Schimko)

5 copies
1 copy for files
4 copies to addressees

I certify that this is a correct translation:
signed Marquat, Sondefuehrer (G)
/Noncommissioned specialist/

*Source: GADS Special order (translation) dtd 7 July 44, by HQ 16th Infantry Division, in Third Panzer Army G-2 File.

**Ic/AO corresponds to U.S. Army G-2 staff section.

SECRET SECURITY INFORMATION

APPENDIX III*
Item 1

POLITICAL INTERROGATION
DIRECTIVE

[Note: See pages 170ff of the text for a discussion concerning the origin of this document. The date, 1944, in the text (page 170) is an error, the document having been captured by the Germans in the spring of 1942. A covering letter, not reproduced here, accompanied the German translation of this document which stated that the original Soviet document was dated 3 October 1941, that it was issued by the Main Political Directorate of the Peoples' Commissariat of Defense, and that it was signed by L. Mechlis.]

Annex to OKH, Army General Staff-Fourth General Staff Officer, Branch Foreign Armies East (II c) No. 1609/42 Confidential, Dated 19 April 1942.

Translation

Directive Concerning the Political Interrogation of Captured Enlisted and Officer Personnel

1. From the moment of his capture by the Red Army and during the entire duration of his captivity, the enemy enlisted man (officer must be under continuous indoctrination by political workers. The basic objectives of this indoctrination are:

- a. To discover, unmask, and isolate fascist elements;
- b. To arouse class consciousness and to re-educate along anti-fascist lines the soldiers who were deceived by Hitler and his henchmen;
- c. To round up soldiers of antifascist conviction and give them a comprehensive political indoctrination.

2. The political interrogation of prisoners of war is to pursue the following objectives:

- a. To ascertain the political and moral attitude of interrogated personnel;

*Source: Directive on the Political Interrogation of Captured Enlisted and Officer Personnel, dtd 3 Oct 41, in document file of Army Group North, Butebefshlc, Ic/AO, 15.IX.41 - 2.I.43.

SECRET SECURITY INFORMATION

- b. To ascertain the political and moral condition of the unit in which the prisoner served;
- c. To determine the type of ideological training which the soldiers have received as well as the subject matter of such training and the topics used in discussion;
- d. To obtain information on the effect of Russian propaganda and on antifascist activity among the enemy's [frontline] troops and the army rear area;
- e. To indoctrinate the prisoner morally and politically so as to unmask fascism and arouse sympathies for the Workers' Council among the elements which are socially akin to us;
- f. To collect material and information which may be important to our propaganda efforts directed at the enemy's troops and population.
3. The political interrogation is to be conducted by the political workers of the divisions, armies, and army groups, i.e. by those who have command of the appropriate foreign language and who have been cleared for this work by order of the chiefs of the division and army political sections or by the political directorates of the army groups. If necessary, a suitable and certified interpreter can be assigned to assist the interrogator. The presence of other personnel not cleared for interrogation duties is not permitted.

Note: Wounded enlisted men and officers will be subject to the same interrogation procedure as other prisoners; the interrogation, however, will be shortened. Recaptured prisoners will be subjected to a complete interrogation by the camp commissars.

Without exception, interrogations will be conducted individually and orally. Written statements pertaining to one or the other question can be requested from the prisoner only after termination of the oral interrogation. If a group of prisoners is on hand [the following procedure should be followed]:

- Separate officers and enlisted men immediately in order to prevent the officers from influencing the enlisted men;
 - Interrogate the enlisted men first, then the noncommissioned officers, and finally the officers.
4. The interrogator will be guided by the attached questionnaire and will see to it that the information to be obtained will be as complete as possible. Supplementary questions may be asked, if the

-14-

Appendix III
Item 1**SECRET SECURITY INFORMATION****SECRET SECURITY INFORMATION**

importance of the person to be interrogated warrants it. In dealing with prisoners, the dignity of Red Army personnel must be preserved. Familiarity must be prevented by all means.

5. The attached questionnaire is to be used in interrogating enlisted men and noncommissioned officers (up to and including the rank of Feldwebel [platoon sergeant]) who have a labor or farm background. When interrogating prisoners from other social strata, the interrogator will make appropriate changes in the relevant questions (see Section III of the questionnaire). Members of the SS and Military Police (Feldgendarmarie) will be asked supplementary questions. Appropriate changes will also be made in interrogating prisoners of non-German nationality (including Austrians and Poles).

6. Information obtained from a prisoner is to be checked and supplemented through appropriate interrogation of other prisoners.

7. Each interrogation will be recorded in a detailed written report. In order to avoid mistakes in the spelling of proper names, geographical terms, etc., such names and terms will be recorded in the language of the prisoner as well as in Russian. Furthermore, certain characteristic expressions and phrases will be taken down verbatim. Arguments of the prisoner pertaining to fundamental political questions (particularly arguments directed against the fascist regime and the war of degradation unleashed by Hitler) must be recorded with particular care.

8. In writing the report, general and vague statements and conclusions must be avoided. Every fact which testifies to the disintegration of the political and moral structure of the army and the zone of interior is to be recorded accurately and in detail: who [said it], where [was it said], to whom [was it said], when was it said and what was said, what was done, under what circumstances [was it done], etc.

9. Each report must be drawn with care (date, signature). The political sections of the divisions will forward the reports to the political section of the army, which in turn will transmit them to the political directorate at army group. The army group political directorates will forward the interrogation reports to the Main Political Directorate of the Red Army. A copy of each interrogation report will be sent to the commander of the transit camp, to which the prisoner is assigned prior to being shipped to an appropriate [permanent] PW camp. The report will be accompanied by a photograph of the interrogated prisoner (showing him, if possible, in a clean and well-groomed condition). On the back of the picture, the name, unit, date of interrogation, and number of interrogation report will be noted.

-15-

Appendix III
Item 1**SECRET SECURITY INFORMATION**

SECRET SECURITY INFORMATION

10. Documents (letters, diaries, photographs, orders, directives, newspapers, and magazines) will be forwarded to the Main Political Directorate of the Red Army. Letters, diaries, and photographs will carry, if possible, a notation listing the name and [civilian] occupation of the source, his unit, and the date of capture.

SECRET SECURITY INFORMATION

APPENDIX III*
Item 2

GUIDE FOR THE POLITICAL INTERROGATION OF PRISONERS

[Note: For a discussion concerning the origin of this document, see page 175 of the text. This document is an annex to the foregoing political interrogation directive (Item 1) but is presented here as a separate item because it was obtained from another source.]

Korpsgruppe**Breith
G-2 [Ic] Section

In the field, 29 May 1942

Copy of a "Guide" for the political interrogation of prisoners of war, found among the papers of a commissar (HQ Sixth Army?) killed in action in the pocket south of Kharkov.

Copy

Guide for the Political Interrogation of Prisoners of War
(from the "Directive Concerning the Political Interrogation of Captured Enlisted and Officer Personnel")

Restricted

28 March 1942

I. General Data

1. Date and place of interrogation.
2. Organization, rank, and name of the interrogator.
3. What is your first and last name?
4. When were you born?

* Source: Guide for the Political Interrogation of PW's dtd 28 Mar 42, in G-2 file of 3rd Panzer Division, Anlage II zum Teetigkeitsbericht, Ic, Ausgehende Meldungen, Akte I, Russland, 7.II.-31.VIII.42.

**Korpsgruppe: Two or three understrength divisions assembled into a tactical unit under a corps commander with an improvised corps staff.

SECRET SECURITY INFORMATION

5. Where were you born? (Locality and province)
6. What is your military rank?
7. To which unit do you belong? (Specify)
8. To which party did you belong? (Include affiliations prior to entering military service)
9. What is your nationality?
10. What is your religion?
11. What is the occupation of your parents?
12. What kind of an education do you have?
13. What is your profession or occupational specialty?
14. Where were you last employed? Until when and in what position?
15. What is your home address?
16. Are you married or single? Do you have any children?
17. To what party do or did the members of your family belong?
18. Are any political refugees or emigrants among your friends or relatives or were any of them persecuted or punished for political reasons?
19. Who are they and where are they?
20. When did you enter the Armed Forces? (As a volunteer or draftee?)
21. Did you take part in the First World War?
22. On which fronts have you fought since 1939?
23. When did you arrive at the Russian Front?
24. Do you have any awards or decorations? When did you win them and for what?
25. Where, when, and under what circumstances were you captured? (Or did you desert?)

-18-

Appendix III
Item 2**SECRET SECURITY INFORMATION****SECRET SECURITY INFORMATION**

II. Condition of the German Armed Forces (Wehrmacht)

A. The Soldier's Life

1. How well-fed are the German soldiers? (especially lately)
2. How is the equipment in your unit?
3. What are the health conditions?
4. Is medical care available?
5. Did you have any days of rest, and did you get enough sleep?
6. As a soldier, on what did you spend most of your money?
7. What do you know about the operations of [military] censorship?
8. How often did you receive mail from home?
9. What do you know about the censorship?
10. Does the soldier at the front have any opportunity for sexual intercourse?
11. What is the average age of the soldiers in your organization?
12. What are some of the topics of conversation among the soldiers?

B. Indoctrination of the Soldiers

1. Did you have political discussions, lectures, or hours of instruction in your unit?
2. What were the topics?
3. Who conducts such lectures or courses?
4. Does your organization have a library? What kinds of books does it have?
5. Do you receive "circular letters" from Germany? From whom, how often, and what do they contain?
6. Did you receive newspapers from Germany?
7. Did you receive military periodicals and political pamphlets? What did they deal with?

-19-

Appendix III
Item 2**SECRET SECURITY INFORMATION**

SECRET SECURITY INFORMATION

8. Were you informed about the military situation at the front? What was the latest report?
9. Which front newspapers published by the Wehrmacht for German soldiers did you read?
10. What part do the chaplains play in furnishing the troops with spiritual guidance?
11. How does the German radio propaganda operate among the Armed Forces? What does it consist of?
12. Have you seen any films lately? Which ones? Are there any movies at the front?
13. What do you know about the activities of the propaganda companies?

C. Relations with Superiors

1. From which strata of the population do the officers come?
2. How do the officers treat their subordinates?
3. How do the officers react to the grievances and complaints of the soldiers?
4. Do officers require enlisted men to perform personal services?
5. Do you know of any cases of physical mistreatment or shootings perpetrated by officers, or do you know of officers susceptible to bribery?
6. Do officers attempt to win over individual soldiers by extending favors?
7. Describe some characteristic aspects of an officer's everyday life.

D. Relations of the Soldiers to Each Other

1. Do you know of any cases of denunciation?
2. Are there overly ambitious men ["eager beavers"] among the troops?
3. How do the Austrians and Germans get along with each other?
4. How are the relations between the soldiers and the noncommissioned officers?

-20-

Appendix III
Item 2**SECRET SECURITY INFORMATION****SECRET SECURITY INFORMATION**

5. How do regular army men and reservists get along with each other?
6. How do the older men and the younger men get along with each other?
7. How are relations between members of the various branches of the service?

E. Military Questions

1. What do you know about the military qualifications and professional skill of your officers and noncommissioned officers?
2. What do you know about German losses of men and material at the front?
3. How often and in what manner has your organization received replacements?
4. Did your unit have much opportunity for rest [and recuperation]? How often has it been reorganized?
5. What do the men in your unit say about the partisans? What damage have the latter inflicted?

F. Discipline

1. Do you know of any violations of discipline?
2. Does it happen that the orders from officers are not carried out?
3. Did any soldiers refuse to enter combat?
4. What was the cause of such incidents?
5. What were the consequences?
6. Mention a few typical courts [martial] sentences or penalties.
7. Do you know of any cases of desertion, malingering, self-mutilation, or suicide? (Furnish exact data)

G. Security Organizations [Operating]
Within the Wehrmacht

1. What do you know about the operating procedure of the Gestapo in the Wehrmacht?

-21-

Appendix III
Item 2**SECRET SECURITY INFORMATION**

SECRET SECURITY INFORMATION

2. What role does the military police play and what functions does it perform?
3. How do the military courts in the field and in the zone of interior operate?
4. What is the role of the SS and SA in the Wehrmacht?
5. How high is the percentage of national-socialists in the Wehrmacht?
6. What role do they play?
7. What is the attitude of the soldiers toward the Gestapo, SA, and SS?

III. Conditions in the Zone of Interior

A. The Financial Condition of the Prisoner Prior to Induction into the Wehrmacht and the Condition of his Family Prior to the War:

[Questions for] Workers:

1. Where were you last employed?
2. How long have you been working?
3. How long was your working day?
4. In which respects is the worker protected by law?
5. How much was your weekly wage?
6. How much were the weekly deductions, taxes, fines, etc.?
7. What were your principal expenses, and what percentage of your wages did they constitute?
8. Did you have a savings account? If so, what happened to it?
9. How was your housing situation, and how much rent did you pay?
10. How high were your expenses in case of sickness?
11. How much did you spend for food?
12. How much did you spend on the education of your child(ren)?
13. What grievances and complaints do the workers have?

-22-

Appendix III
Item 2**SECRET SECURITY INFORMATION****SECRET SECURITY INFORMATION**Farmers:

14. How large is your farm?
15. How much and what kind of cattle do you have?
16. How high are the taxes and other assessments?
17. What did your income and expenses consist of?
18. Did you receive any credit? How much and from whom?
19. What grievances and complaints do the farmers have?
20. What do you think of the Farm Succession Law [Erbhofgesetz]?
21. What do you think of the so-called "Farmers' Leaders" [Bauernfuhrer]?

B. The Family under Wartime Conditions

1. How long is the work day for members of your family at present?
2. How high are the wages? How high are deductions and taxes?
3. How is the supply of food and consumer goods?
4. How does the increased cost of living manifest itself?
5. Can all merchandize be bought on the open market?
6. Did you receive any small packages from home? Did you send any small packages? What were their contents?
7. Are there any transportation difficulties?
8. What have you heard about air raid victims and destruction caused by air raids?
9. Have the Government or individual organizations taken measures to render aid?

C. The Political Situation

1. Are there any conflicts between workers and managers in the plants?
2. How are they caused and how are they resolved?

-23-

Appendix III
Item 2**SECRET SECURITY INFORMATION**

SECRET SECURITY INFORMATION

3. Do you know of any clashes between workers and officials, police, SS, or SA?
4. What were the reasons?
5. What can you tell us about local and district "leaders" of the NSDAP, SA, and SS, chiefs of police, Gestapo [personnel], mayors, etc., and about their past?
6. How are relations between them and the people?
7. Do you know of any people who are dissatisfied with conditions?
8. What do you know about the activities of the anti-Hitler forces at home and in the armed forces?
9. In your opinion, why are people dissatisfied?
10. How do suppression of the Church and religious persecution manifest themselves?
11. What do you think of the war against Russia? Do your friends think the same way?
12. What do you think of the Goebbels propaganda and the reports of the Armed Forces High Command?

IV. Political Attitude and Convictions of the Prisoner

1. How do you feel about the Hitler regime, the national-socialist "leaders," and the so-called "German Socialism"?
2. What do you think of the occupation of a number of European countries by the German Wehrmacht, of the policy of spoliation and brute force, and of the propaganda extolling hatred of other humans and class supremacy?
3. When, where, and from whom did you receive the news about the outbreak of the war against Russia? How do you feel about the war against Russia? What do you think of "Hitler's allies"?
4. When did you cross the Russian border? What was the route of advance? In which battles in Russia have you participated? How did the Russian population conduct itself toward the German troops? How was the conduct of the German troops toward the [Russian] population? What cases of cruelties committed by German officers and enlisted men against Red Army soldiers and commanders and against the local population are known to you? (Specify the locality). Do you know of any instances in which individuals

-24-

Appendix III
Item 2**SECRET SECURITY INFORMATION****SECRET SECURITY INFORMATION**

- among the population aided the German troops? How is civil government organized in the temporarily occupied areas? Mention names and functions [of officials] and give a brief personal description of the "interpreters" with the German headquarters. What do you know about the treatment of captured members of the Red Army?
5. What is your attitude toward the Russian people and the Soviet regime?
 6. What do you think of the combat efficiency of the Red Army and the partisan movement?
- What do you know about Bolshevism, the Bolsheviks, and the commissars?
- Along which lines were you politically active prior to your induction and during your military service? Have you been punished for such activities?

V. Attitude toward Soviet Propaganda

1. Do German soldiers read the Russian leaflets and newspapers?
2. What is the German soldiers' opinion of Russian leaflets and radio broadcasts?
3. Which questions come to mind when the German soldiers read the Russian leaflets or listen to Moscow radio broadcasts?
4. What is the main reason for the German soldiers' reluctance to surrender?
5. What, in your opinion, should we write about primarily in our leaflets for the German soldiers?
6. On which subjects would the German soldiers like to receive more specific information?

-25-

Appendix III
Item 2**SECRET SECURITY INFORMATION**

SECRET SECURITY INFORMATION
APPENDIX IV*

SHORT TRAINING COURSE FOR RED ARMY
INTERROGATORS IN THE FIELD

[Note: This appendix consists of a German prisoner-of-war interrogation report. Interrogation was made by 1st Lt. Sakharov, translation from Russian by 1st Lt. von Velville.]

Army High Command
Army General Staff
Branch Foreign Armies East (IIIA)

Hq., 11 August 1944

Prisoner of War Interrogation
of

Rank: Captain
Name: Pupikin, Vladimir Dmitrovich
Military Position: CO Recon Bn
Last Unit: 159th Infantry Division, XXXV Infantry Corps,
Fifth Army, Western Front
Captured: 19 July 1944 At: Kauen
Born: 15 June 1914 At: Stalingrad area
Nationality: Russian Civilian Occupation: Electrician
Bookkeeper

Subject: Instructions for the Interrogation of Prisoners of War
by Intelligence or Reconnaissance Officers of the Red Army

Captain Pupikin (a prisoner of war) attended a three-day course for reconnaissance officers in the vicinity of Smolensk from 9 to 12 June 1944. One lecture hour was scheduled for prisoner-of-war interrogation procedure. In addition, the course included a demonstration interrogation accompanied by a lecture.

*Reference: Interrogation Rpt, Directives for the Interrogation of PW's by Reconnaissance Officers of the Red Army, dtd 11 Aug 44, in German PW Affairs Files, Foreign Armies East.

-26-

Appendix IV
Page 1

SECRET SECURITY INFORMATION

SECRET SECURITY INFORMATION

The lecture was given by the Chief of the Research Branch of the Intelligence Directorate for the Western Front. The interrogation of the prisoner lasted about fifteen minutes. A blindfolded prisoner of war was led into the lecture room. All documents on his person were removed and the interrogation began. The prisoner had obviously been procured from a prisoner-of-war camp. The answers he gave to questions were previously prepared statements. An intelligence officer carried out the interrogation. The interpreter translated literally without any revisions.

The lecturer instructed the students in the following manner as to the execution of the interrogation:

1. The interrogating officer will put his questions directly to the prisoner of war and not to the interpreter.

2. Prior to the interrogation, the interrogating officer has to familiarize himself with the statements of other prisoners from the same sector of the front. If possible, he is to have the relevant interrogation reports and a map of the pertinent sector before him.

3. A questionnaire containing the items in which higher headquarters is interested must be available.

4. No record is to be kept during the interrogation itself. Only short notes may be made. The record is to be written after the interrogation and not in the presence of the prisoner.

5. Prior to the interrogation proper, the veracity of the prisoner's statements is to be ascertained. This is best done in the following manner: The prisoner is first asked the first and last names of the members of his squad and platoon. After a lapse of a period of time, these questions are repeated. If the statements are identical, it may be assumed that the prisoner is telling the truth.

6. The prisoner is to eat prior to the interrogation and is to be treated to brandy and cigarettes.

7. The interrogation is to be conducted in a polite manner.

8. The prisoner is to gain the impression that the information about his unit, which is expected from him, is already known and was previously ascertained from statements by other prisoners of war.

9. If the prisoner refuses to answer, the interrogation is to be stopped. Later, the interrogation will be started anew by another person who will deal with the prisoner in accordance with the latter's psychological characteristics. In the course of this interrogation the prisoner may also be tricked.

-27-

Appendix IV
Page 2

SECRET SECURITY INFORMATION

SECRET SECURITY INFORMATION

10. If the prisoner in question is healthy, he will be drawn out by questions from other, previously captured prisoners, who have been recruited as agents. The latter will use a comradely and cordial approach in starting conversations with the prisoner. Another method to be employed is the planting of an intelligence officer, who has command of the German language, in a cell next to that of the prisoner. Through an opening in the wall, he will establish contact with the prisoner. He will act as if he himself has just been captured and will seek to obtain information through friendly conversation.

11. In especially important cases (only in interrogations at the intelligence directorate [Verwaltung fuer Feindaufklaerung]) narcosis will be used.

12. Intelligence officers or women interpreters, disguised as doctors, nurses, or nurses aides, will be employed for the "care" of sick and wounded prisoners. This "medical personnel" will seek to win the confidence of prisoners through special attention, care, sympathy, and presents. Conversations will be started about home, relatives, the weather, sickness, et cetera. Powdered sugar and drops of cherry juice will be given as "medicine." Step by step, treatment of the prisoner will continue with great caution until he reveals the desired information.

13. It is recommended that immediately after capture soldiers be interrogated by regimental and divisional intelligence officers on the spot; that is, as far forward as the main line of resistance or the trenches.

14. During interrogation, the regimental, divisional, corps, and army intelligence officers are to place emphasis on the following questions:

- a. Training of the prisoner;
- b. Strength and combat effectiveness of his unit;
- c. Reserves;
- d. Artillery;
- e. Tanks;
- f. Engineer equipment;
- g. Equipment for chemical warfare;
- h. Medical and veterinary facilities;
- i. Morale and political attitude of the troops;
- j. The mission of the unit.

SECRET SECURITY INFORMATION**SECRET SECURITY INFORMATION**

APPENDIX V*

Military Institute of Foreign Languages

[Note: Portions of the original report have been paraphrased or summarized. Names of Soviet officers and officials have been omitted.]

This report contains information on the Military Institute of Foreign Languages in Moscow. It was obtained from a Soviet Officer deserter who attended the institute from January 1946 to July 1948. . . .

After ten years of schooling, Source was graduated from middle school in the spring of 1945. In August 1945, he took a special course in the Czech language at the Military Institute of Foreign Languages and was graduated with high honors in January 1946. Most of the graduates were sent to various military units, but Source's teacher was able to obtain for him an appointment to a regular course at the Institute. Source passed a few examinations and was accepted into the second semester of the second year of the First Faculty, joining a class which had entered the Institute in the fall of 1944. He continued to specialize in the Czech language.

Source has given information on the following questions:

1. What Organization controls and directs the Institute?

The institute is under the Ministry of the Armed Forces (MVS).

2. What is the relation of the Institute with the MGB and other agencies?

In some exceptional cases, members of the MGB attend the Institute. Normally, however, MGB personnel attend the MGB's own language schools. Some MVD officers, principally from border units, attend the school. Institute graduates may go to the MGB, the Soviet Council of Ministers, certain ministries, and the Central Committee of the All-Union Communist Party.

3. What is the over-all organization of the Institute?

*Reference: USFA Report No. R-506-49, 18 Oct 49, Sub: (Soviet) Military Institute of Foreign Languages, (S).

SECRET SECURITY INFORMATION

SECRET SECURITY INFORMATION

Under the Commanding Officer and his Administrative Staff, the Institute is divided into four Faculties. Each Faculty gives a different kind of general course, with individual variations in each student's course according to the language he is studying. (Comment: So far as can be gathered from Source's description, a Faculty is similar in nature to a College of an American university.) Each Faculty has an administrative staff. The teaching staff for all four Faculties is divided into 15 Departments according to the subjects taught.

4. Give the Command and Administrative Staff of the Institute.

(Note: Names omitted here.)

Chief of the Institute
Deputy Chief for Educational and Scientific Matters
Chief of Educational Department
Chief of Political Department
Chief of the Personnel Department
Chief of the Administrative Department

5. Give the Organization, Functions, and Personnel of the four Faculties.

a. The First Faculty supervises the courses in all European languages. Students in this Faculty are trained to become qualified translators and interpreters.

Chief of the Faculty -- Colonel
Assistant for Political Matters -- Lt. Colonel
Assistant for Educational Matters -- Captain
Chiefs of Courses -- Colonels and Lt. Colonels

b. The Second Faculty is similar in curriculum to the First except that its students specialize in Oriental languages. Source does not know the staff. . . .

c. The Third Faculty is the School of the Main Political Administration /Directorate/ of the Armed Forces of the USSR (GPR VS SSSR). It trains officers as political workers, speaking foreign languages, to work as Communist agitators and propagandists. Source does not know the staff. . . .

d. The Fourth Faculty trains personnel to teach English, German, and French at the various military schools and academies. Chief of this Faculty is a Colonel. . . . Assistant -- Lt. Colonel.

Appendix V
Page 2

30

SECRET SECURITY INFORMATION**SECRET SECURITY INFORMATION**6. Give the Various Departments of the Teaching Staff and their Personnel.

(Note: Source was able to name only a part of the personnel. All names are eliminated here.)

- a. Marxism-Leninism Department
Chief: Colonel; Five Instructors: Lt. Colonels
- b. Political Economy Department
Chief and three instructors
- c. English Language Department
Chief and four instructors
- d. French Language Department
Chief and two instructors
- e. Romance Languages Department
- f. Slavic Languages Department
- g. Hungarian and Finnish Languages Department
- h. Oriental Languages Department
- i. Russian Languages and Language Study Methods Department
- j. Military Translation Department
- k. Military Tactics and Operations Department
- l. Orientation Department
- m. General and National Literatures Department
- n. Pedagogical Department

7. What are the two Miscellaneous Courses referred to in No. 3?

(Note: No. 3 contains no reference to "miscellaneous courses," an omission which may have been made when the original report was translated and edited.)

a. There is a special officers' course at which selected officers from various branches of the Armed Forces study several subjects. The English language is the main subject. Others are Marxism, the Russian language, Tactics, and the Armed Forces of the United States and Great Britain.

b. A correspondence course in foreign languages is given to certain officers on duty elsewhere. . . .

8. How long do the Various Courses Last?

At the time Source was a student at the Institute, the courses in the First, Third, and Fourth Faculties lasted four years. The course of the Second Faculty lasted five years. Beginning in the fall of 1949, the courses of the First and Fourth Faculties will be lengthened to five years. There will be no graduating classes from these courses in 1950. The special "Officers' Course" lasts two years.

9. How are the school years divided?

Appendix V
Page 3

31

SECRET SECURITY INFORMATION

SECRET SECURITY INFORMATION

Each school year is divided into two semesters. One semester begins in August and ends in December with mid-year examinations, followed by a vacation of about ten days. The second semester begins in February and ends in early summer with yearly examinations. Students then undergo a period of training in a military camp or other practical work, followed by a one month leave.

10. How are students for the Institute selected?

At the time Source was a student, members of the Armed Forces as well as civilians were accepted by the Institute. Source expects that in the future, only military personnel will be accepted. Military personnel have to go through several steps before acceptance. First, officers from the Institute visit all Military Districts (and Fronts) and select possible candidates from records kept at headquarters. These candidates then take an examination in the Russian language. Those passing this test go to the Institute for more detailed examinations. Successful candidates must pass tests in the Russian Language and Literature (corresponding to ten years' schooling), Geography, and History of the USSR. . . . Sometimes examinations in a foreign language and in current events.

Students for the Third Faculty are selected only by the Main Political Administration of the Armed Forces.

11. How many students are at the Institute?

At the time Source was a student there, the Institute had between 2,000 and 2,500 students in attendance. Source's class had between 180 and 200 students, but classes in the various Faculties differ in size. The Fourth Faculty had the fewest students. About 100 English-speaking students are graduated each year.

12. What percentage of each class fails to graduate? What reasons?

Between ten and fifteen per cent of each class fails to graduate; the majority for scholastic deficiencies. On several occasions, students were ordered to other military assignments before completing their courses, even though they had not failed their course.

13. How efficient is the teaching of the Institute?

The teaching is partly good and partly bad. Source heard that ----, the English teacher, was very good and his wife was poor. Some of the graduates speak the language they studied very well. Others speak surprisingly badly. . . . He believes that the average students of English speak well and fluently, but with an accent, and could not pass as Americans or Englishmen.

SECRET SECURITY INFORMATION

14. How and where are graduates assigned?

Graduates of the First and Second Faculties may be assigned to positions with any branch of the Armed Forces; with one of several ministries, including the MGB, or with the Central Committee of the all-Union Communist Party. Source knows that graduates have been assigned to such various positions as the staff of a tank division; the staff of the Foreign Relations Department of the Ministry of Armed Forces; the staff of a Military District Command; MGB service in the United States and Mexico; with Armed Forces intelligence units in Germany and Austria; with military attache staffs; and with repatriation missions in Western Europe. Graduates assigned to the Soviet Navy may serve aboard ships or with naval headquarters.

The various agencies needing graduates from the Institute come to the Institute late in the school year (April, in Source's case) to conduct interviews with fourth-year students who are not already earmarked for assignment. At the end of the term, graduates receive orders from the General Staff giving their assignments. Source received orders to report to the Personnel Administration of the GRU; there he was given his specific assignment.

Graduates of the Third Faculty are given their assignments by the Main Political Administration (Directorate) of the Armed Forces. Graduates of the Fourth Faculty are theoretically to be assigned to teaching languages in various Armed Forces schools. In practice, however, many end up in non-teaching positions. For example, eight female graduates of this Faculty are attached to the Soviet Element of the Allied Commission for Austria.

15. Are any intelligence courses given at the Institute?

No actual intelligence courses are given at the Institute. Some of the courses are indirectly helpful in the training of an intelligence officer. Source states that during the war Genleut Bijzki, the Commanding Officer of the Institute, attempted to organize several courses in addition to the ones now existing. Of these, the Seventh Faculty was a special intelligence course. This experiment did not succeed, and after a few months, the Institute reverted to the original four Faculties.

16. Do military intelligence officers, other than those slated to be interpreters, attend the Institute?

No. They study languages in other schools.

17. Do graduates who have been earmarked for assignment with Military Intelligence receive any intelligence training?

No. They go directly to their assignments without further training.

SECRET SECURITY INFORMATION

18. Is the commanding officer of the Institute a military intelligence officer? Is the chief of the First Faculty?

Yes. In both cases.

19. What are the State examinations given to Institute students? How many of them are there?

At the end of their last year, students at the Institute must pass two or three State examinations, depending upon the Faculty which they have attended. These examinations cover the student's entire course, First Faculty students must pass examinations in their main language and in Marxism-Leninism. Second Faculty students take examinations in two languages . . . as well as in Marxism-Leninism. Students in the Fourth Faculty take examinations in Pedagogy, in a foreign language, and in Marxism-Leninism.

20. What are the students' military status?

All students at the Institute receive uniforms immediately upon acceptance, but they hold the rank only of "special student" (slushatel) until they pass their second year. They are then commissioned Junior Lieutenants. Graduates receive the rank of Lieutenant.

21. What pay do students receive?

Students receive 300 rubles a month during the first year and 450 rubles during the second. During the third year, they receive the pay of Junior Lieutenants holding the job of squad leader or section leader -- 400 rubles monthly base pay and 650 rubles for special job pay. Fourth year students receive 400 rubles base pay and the 750 rubles special job pay to which an assistant company commander is entitled. Graduate Lieutenants receive 500 rubles base pay plus the special pay of the position to which they are assigned. Source received 1,150 rubles special pay as an interpreter who had graduated from the Institute (non-Institute translators receive less special pay). Military personnel entering the Institute continue to receive the pay of their last assignment if that is higher than they would receive at the Institute.

22. What recreational facilities are available at the Institute?

Club and recreation rooms . . . various sports . . . drama circle, band . . .

34

Appendix V
Page 6

SECRET SECURITY INFORMATION

SECRET SECURITY INFORMATION

23. What subjects did students of the First Faculty study during Source's attendance at the Institute?

First Year -- First Semester:

1. Foreign Language (Phonetics, Grammar); 2. Marxism-Leninism; 3. Military Topography; 4. Literature of Ancient Greece and Rome; 5. Contemporary Russian Literary Language; 6. Orientation -- Global Political Geography (general historical-geographical review of the world, except the USSR); 7. Introduction to Language Study (Linguistics); 8. Stalin's Speeches and Orders dealing with the "Great Fatherland War" (This was a wartime study only; it is now combined with Marxism-Leninism.)

Second Semester:

1. Foreign Language; 2. Marxism-Leninism; 3. Tactics (Use of personal weapons, drill regulations, infantry squads and sections in attack and defense); 4. Literature of the Middle Ages; 5. Contemporary Russian Literary Language; 6. Orientation - Physical and Economic Geography of the World except USSR; 7. Introduction to Language Study. Practical Training: After first year examinations, the students attend a military training camp for practical training in the theory learned in the Military Topography and Tactics courses.

Second Year -- Third Semester:

1, 2, and 5. Same as second semester; 3. Tactics - Military History up to the Civil War in Russia (1918-1922); 4. Literature of the 18th Century; 6. Orientation - History of the student's special country. . . .

Fourth Semester:

1. Same (including Military Translation); 2. Same; 3. Tactics (Principles of Warfare: infantry company and battalion in combat, both offensive and defensive); 4. Literature of the 19th Century; 5. Orientation (same as before, continued). Practical Training: Students after the Second Year again attend a Military Training Camp for continued infantry drill and an examination in Tactics.

Third Year -- Fifth Semester:

1. Foreign Language; 2. Same (at present Marxism-Leninism is not taught after second year); 3. . . .

Appendix 5
Page 7

SECRET SECURITY INFORMATION

SECRET SECURITY INFORMATION

Political Economy; 4. Literature of the 20th Century;
5. Orientation - Political and Governmental of the
student's special country; 6. Tactics (study of the
military forces of the United States and Great Britain);
7. Second Foreign Language.

Sixth Semester:

1, 2, and 3. Same as above; 4. Auxiliary Theory (in
Source's case, study of old Slavic and old Czech language
theory); 5. Orientation - Literature of student's special
country; 6. Second Foreign Language.

Practical Training: After the 3d year, students are
placed in the summer in a special job to obtain practical
training in the use of their foreign language. Source
spent a month with MVD Border Guard troops on the Slovak-
USSR border. He actually did this after his Second Year.
. . . case not normal.

Fourth Year -- Seventh Semester:

1. Foreign Language (with emphasis on style), a. Trans-
lation from Language into Russian, b. Translation from
Russian into Language; 2. Same; 3. Same; 4. Orientation-
Geography of the United States and Great Britain; 5.
Second Foreign Language.

After finishing and passing the fourth year examinations, students
are given about one month to prepare for the State examinations. After
passing these, the students receive their diplomas and await further
assignment.

24. (Names of fellow students and present assignments. Deleted
from this appendix.)

SECRET SECURITY INFORMATION

APPENDIX VI

DOCUMENTARY EXCERPTS:
SOVIET METHODS OF INTERROGATION

Note: These short excerpts from various documents will serve
to illustrate methods of interrogation practiced by Soviet inter-
rogators. The collection is by no means comprehensive nor is it
designed to reveal a specific pattern of Soviet behavior; these
examples are merely representative of the larger body of source
materials upon which this study is based.

Part One of this appendix consists, for the most part, of
case histories of prisoner-of-war interrogation. Part Two presents
examples of methods of interrogating citizens of the Soviet Union
and its satellite states.

PART ONE
Item 1*

Note: The source of this report was Major M. P. Ossnovich,
Russian PW, formerly intelligence officer on the staff of the
20th Guards Cavalry Division (Red Army).

Treatment of Prisoners:

Unless prisoners offer stubborn resistance at the time of
capture, their lives are spared, no matter whether they are officers
or enlisted men. Officers are sent to army headquarters after a
brief interrogation at division. From army, they are shipped to
assembly camps. Enlisted men, unless they can reveal important
information, are shipped directly to the assembly camps after their
interrogation at division. German prisoners of war are allegedly
not used in industry and agriculture because of the danger of

*Source: Interrogation report, dtd 28 Dec 42, in G-2 file of 78th
Assault Division, I C. Anlage Zum Kriegstagebuch, Gefangenen -
Vernehmungen, 12 VIII. -28.XII.1942.

SECRET SECURITY INFORMATION

sabotage. Subject claims ignorance of deliberate shootings of prisoners, although he was impressed with German experiences to the contrary. [Note: The need for prisoners as laborers quickly overcame Soviet fears regarding sabotage.]

SECRET SECURITY INFORMATION

Item 2*

After the first interrogation comes the second one. . . . Treatment becomes more and more severe. . . . Threats are uttered such as, "We shall beat the living daylight out of you," or "We shall make you dance the fascist trot." This means that the victim, dressed in a fur coat, is forced to double-time for hours in a very hot room. . . .

If the prisoner refuses to comply, he is placed into confinement. . . . The place of confinement. . . is a dark stone dungeon, furnished solely with a bench of stone or iron. The floor is covered with sharp-edged stones. The victim, clad only in swimming trunks, is thrown into this room. If he stands, the soles of his feet hurt, and the bench is too cold to permit sitting down. The only way he can relieve himself is on the floor, and after a few days the air becomes so foul that breathing it becomes almost intolerable. . . .

The first stage of interrogation was conducted in the following manner: I had to sit down on a stool. Sitting at rigid attention with the arms hanging down, I spent 108 hours maintaining this posture. I collapsed twice, and the subsequent breaks are included in the above period. The guard personnel saw to it that I neither slept nor moved. (according to NKVD regulations, this kind of torture is permissible up to 180 hours.) After I had spent two days in this position, I felt terrible pains in the abdominal region, and

*Source: "Bolshevist Torture Methods" and "Interrogation Methods in the USSR" in Anti-Komintern File, "der Rote Terror II" (Red Terror II), EAP 116/56.

SECRET **SECURITY INFORMATION**

in particular in the region of the kidneys: my hands and feet swelled considerably. . . . After 108 hours, I was taken back to the prison more dead than alive. Walking was out of the question. My feet had swollen out of shape. Each step, each movement, caused unbelievable pain.

I enjoyed a respite of five days. Then the procedure of sitting on the stool started anew. This time, only about half of the stool was to be used. The feet had to be stretched out. I was tortured in this manner over a period of 62 hours and was then permitted to recuperate for three days.

On the night of the fourth day . . . began the second stage of interrogation. I was permitted to sit down but only in such a manner that my coccy rested on a corner of the stool. My hands and feet were to be stretched out. After only a few minutes, I felt excruciating pains in the spinal column. These pains increased immeasurably since I was positively prohibited from moving. After approximately half an hour, the hands and feet showed the first symptoms of cramp. By mustering every ounce of energy, I sat in this position for two hours and forty minutes. Then I was returned to the cell where I again spent a month.

After that, interrogations started again. At this point, the interrogator tried to elicit the statements he wanted by subjecting me to sunlamp treatments (one lamp shone on the right and another on the left side of my head). After approximately two and a half hours, the ability to think is completely arrested. When this, too, was of no avail . . . my hands were tied behind my back. My hands were

40

Appendix VI
Item 2
Page 2

SECRET **SECURITY INFORMATION**

SECRET **SECURITY INFORMATION**

slowly raised by means of a simple pulley until I could stand only on the tips of my toes. I was forced to remain in this position for over an hour. Thereafter, I enjoyed another respite of three weeks.

I was subsequently subjected to the third stage of interrogation, the so-called "conveyor interrogation" (a Russian term meaning "conveyor belt" interrogation, that is, by several interrogators). It was conducted in the presence of four interrogators. I was placed on a stool adjacent to a wall. I was faced by three interrogators, one sitting in front of me and the others on either side. I was asked whether I had finally thought over the points of the indictment and would affix my signature. Since my answer was "no," the interrogator reacted to it with the method of indoctrination which he considered appropriate. The interrogator sitting in front of me shoved my forehead in such a manner that the back of my head hit the wall. Then the interrogator who sat on my right made my head veer to the left by hitting its right side. The interrogator sitting on my left followed his example, so that they carried on a veritable handball game with my head. Including interruptions, during which I was confronted with the same questions time and again, this game lasted for approximately one hour. As late as a week after this treatment, I was, understandable enough, in no condition to muster one coherent thought. In this manner, I was forced to sign confessions which did not contain one word of truth and which, in their entirety, did not correspond to the facts.

I have personally experienced the interrogation methods cited
SECRET **SECURITY INFORMATION**

41

Appendix VI
Item 2
Page 3

SECRET SECURITY INFORMATION

above in the course of my one-year pre-trial confinement. At the same time, I should like to state that they constitute only part of the various interrogation methods practiced by the NKVD. I was told, for instance, by fellow prisoners that they had been whipped with steel scourges. Others were confined in the so-called "moist dungeon."

By means of these methods of extortion, the NKVD is undoubtedly in a position to obtain any confession it desires.

M. L. Engineer

SECRET SECURITY INFORMATION

Item 3*

Note: The source of this report was Pvt Alexei Lewin, Russian (Don Cossack) PW, formerly of the 193d Special Penal Company of the 127th Infantry Division (Red Army).

Interrogation Methods

. . . In order to force a prisoner to give information, there is a method of making the prisoner sit for days "at attention," that is, without any sleep. The prisoner is closely guarded and is prodded as soon as he falls asleep. Another method is to make the prisoner stand for five days until his legs are so swollen as to become barrel-shaped and the blood springs from the veins. Still another method calls for torturing the prisoner with electricity. Electrical contacts are strapped to the prisoner's throat and stomach and he is exposed to a current up to three minutes. A doctor checks on how much current the prisoner can stand. This process involving electric current is repeated after a few minutes and thereafter again and again. Other methods in Russian jails involve resorting to starvation and rubber truncheons. The prisoner has experienced these methods himself and has seen his comrades subjected to them.

*Source: Interrogation Report, dtd 19 Jul 44, in G-2 file of XXXXVII Panzer Corps, July 44.

SECRET SECURITY INFORMATION

Item 4*

Treatment, evacuation, and present location of German PW's

Nearly all prisoners of war were interrogated briefly at regimental headquarters and then handed over to the Special Sections of the NKVD [OO NKVD]. This unit confined them in various prisons . . . Some prisoners were treated humanely; others in a barbarian manner with devices customary in the NKVD: uninterrupted interrogation by day and night, poor food, crowded-living in small cells without sufficient air and sleep, frequent compulsion to testify accompanied by threats with firearms. . . . [A subsequent passage (Section III) cites several specific instances of the shooting of German prisoners.]

*Source: Report on the "Fate of German and Romanian Prisoners of War in Sevastopol," dtd 6 Jul 42, in G-2 file of Eleventh Army, Anlagenband 13 zum Taetigkeitsbericht, Ic/AO, Behandlung deutscher Kgf. 6.VII.-2.VIII.1942. This is a consolidated report compiled by the 647th Secret Field Police Detachment and is based on the statements of eighty Russian prisoners.

44

Appendix VI
Item 4
Page 1

SECRET SECURITY INFORMATION

SECRET SECURITY INFORMATION

Item 5*

[Note: The source of this report was Lt. Admirani Shalamberidse, Russian (Georgian) deserter, formerly a member of Section 7 of the Political Directorate of Army Group Crimea.]

All prisoners, after a short interrogation at division level are turned over to the intelligence section [RU] of the army group (front). The [capturing] troops are not permitted to decide the fate of the prisoners and therefore do not know about the prisoners' lot [subsequent to evacuation]. Interrogation at the intelligence section (Razvedyvatelni Otdel) dealt with questions of a military nature, such as organization [of enemy units], enemy intentions, strength, etc.. Subsequently, prisoners were turned over to Section 7 of the Political Administration. Here, they were interrogated on the political attitude and the morale of the enemy troops and questioned for purposes of obtaining material for leaflets. They were also interrogated on the effect of leaflets which had been dropped [by the Russians] on enemy troops.

After the arrival of Mechlis [Army Commissar, 1st Grade, with the Political Directorate of Army Group Crimea], almost all prisoners were shot after interrogation.

*Source: Interrogation Report, dtd 21 May 42, in G-2 file of Eleventh Army, Eigene Gefangenen-Vernehmungen, Ic/AO, 10.XI.1941 - 10.X.1942.

Appendix VI
Item 5
Page 1

45

SECRET SECURITY INFORMATION

SECRET SECURITY INFORMATION

Many prisoners who refused to give information when interrogated by the intelligence section were shot. PW [source of this report] does not know how the interrogation by the intelligence section was conducted.

During the interrogation by Section 7 of the Political Directorate, prisoners were not treated badly. When a member of Group Mechlis, such as Brigade Commissar Vesslov or Senior Battalion Commissar Samoylov, was present during an interrogation, the prisoners were abused and threatened if they did not testify as desired by the commissar; however, they were not beaten. These prisoners who showed considerable firmness or those whose testimony was very advantageous to the Soviets, were turned over to Mechlis personally for purposes of interrogation. After the interrogation was terminated, the prisoners were generally turned over to the headquarters guard and shot the following morning by the headquarters commandant of the Army Group, Capt. Zitko (formerly a Bospriizorny [Russian term for outlaw homeless wife.]), who was a sadist. The execution took place at the Leninskoye cemetery.

During the time that headquarters was located in Leninskoye, approximately sixty German prisoners were received. Forty of these are definitely known to have been shot. The deserter [source] does not know the fate of the remaining twenty. He assumes, however, that approximately ten more prisoners were shot and that only the remaining ten were evacuated to Kerch and on to Novorossiysk.

Appendix VI
Item 5
Page 2

SECRET SECURITY INFORMATION

SECRET SECURITY INFORMATION

Item 6 *

During a Russian breakthrough on 27 March 1942, I was captured by the Russians together with twenty-four men, including our company commander (1st Lt. Fehrmann), a master sergeant, and three sergeants. At the time of capture, I was stripped of all belongings, among them a sum of 475 reichs marks. At the prisoner collecting point to which I was taken, I joined several soldiers from other companies of the battalion. From there, we were taken to a headquarters farther to the rear. There we were interrogated individually by a Jewish commissar who spoke only broken German.

We were housed in two steam bathhouses (saunas). We were separated, for the time being, from Lt. Faehrmann. The first meal we received on the day of our capture was at 10 o'clock in the evening. The meal consisted of potato soup with a little meat and a piece of bread.

When all prisoners had been assembled in one house, a leaflet composed by a Russian propagandist was handed to us. All prisoners were required to sign this leaflet. A refusal would

*Source: Report on the Enemy Situation, dtd 4 April, in G-2 File of XXVII Corps, Page III, Anlage zum Teetigkeitsberichte, Ic, Feindnachrichtenblatter, 21.XI. 1941 - 31.XII. 1942. Annex 3 to this report comprises a deposition, dated 31 March 1942, by Cpl. Wilhelm Kede about his experiences in Russian captivity and it is from this annex that the above passages were taken.

Appendix VI
Item 6
Page 1

SECRET SECURITY INFORMATION

SECRET SECURITY INFORMATION

have been useless, because in this event we would have been shot. The leaflet stated something about good rations and treatment in Russia: captivity and something to the effect that German prisoners would not be mistreated and that our lieutenant had not been shot. When I was taken to the commissar to be interrogated, he offered me tobacco to roll a cigarette and asked me to come close to the stove where it was warm. In the room, in addition to the interrogating commissar, were two uniformed girls (students) and a woman in civilian attire. They were telephone operators and a secretary, respectively. One of them rolled a cigarette for me from the proffered tobacco since I was unable to do it. Before the interrogation began, I told the commissar that I was hungry whereupon he directed one of the girls to hand me a few slices of bread with butter and sausage from his trunk.

The questions which the commissar put to me during the first interrogation dealt only with personal data and information relative to members of my family. During the second interrogation, which took place at night, I was asked about the following:

1. The food situation.
2. The morale of the troops.
3. Relationship between officers and enlisted men.

Appendix VI
Item 6
Page 2

48

SECRET SECURITY INFORMATION

SECRET SECURITY INFORMATION

In reply, I furnished the following information: *

Re 1. Good

Re 2. The morale of the German people and of the Wehrmacht is good. The people and the Wehrmacht have faith in their Fuehrer.

Re 3. I pictured the relationship with our company commander and termed it good.

The question was put to me whether I would be willing to return to the German lines in order to ascertain the attitude of the troops and, in appropriate cases, persuade soldiers to desert. In the event I accepted this offer, I was to proceed along the following lines: Initially, I was to conceal my PW status and determine the attitude of the soldiers to be approached. Only then was I to persuade dissatisfied elements to desert. In doing so, I was to depict conditions I had experienced in Russian captivity. I asked for time to ponder a reply to this request. [The subject had an opportunity to consult with his company commander who advised him to pretend acceptance so that he could notify relatives of the fate of fellow prisoners and inform his division about enemy intentions.]

When I was led before the commissar and replied in the

*This is an excerpt from a deposition of a German enlisted man who had returned to the German lines after capture by the Russians. It is doubtful that he is telling the whole truth in this instance, since he was entrusted with a mission to secure deserters by the Russians.

Appendix VI
Item 6
Page 3

49

SECRET SECURITY INFORMATION

SECRET SECURITY INFORMATION

affirmative to his question about my willingness to undertake the mission, I had to sign a certificate. In addition to an outline of my mission, this certificate contained a threatening statement to the effect that my parents would be shot upon the successful conclusion of the war by the Russians should I fail to return from this mission. If I executed my mission successfully, I was to receive preference with regard to quarters, treatment, and work. After I had signed the certificate, the commissar asked me whether I wanted to have all of my money back. I replied that I would leave this to his judgment.

[In the evening of the day after his capture, the subject was taken by sled to the rear. In one village which he passed he saw a large concentration of partisans and soldiers. During the first leg of his trip, he was wrapped in a shelter half to prevent him from identifying his surroundings. Arriving at his destination, the subject was led before a Russian captain who briefed him on his mission with the help of a map. The captain pointed out the location of the prisoner's battalion headquarters and directed him to return within ten to fourteen days. After the briefing, subject received his paybook and 75 reichs marks and was given a meal. Subsequently, he was returned by sled to the front and released close to the German lines.]

Appendix VI
Item 6
Page 4

SECRET SECURITY INFORMATION

SECRET SECURITY INFORMATION

Item 7*

Treatment of German Prisoners of War

[Note: The source of the first cited report is Major Vassiliy Sudarev, Russian PW, formerly a member of the 1027th Infantry Regiment of the 198th Infantry Division. The source of the second cited report is 1st Lt. Bogdanov, Russian deserter, formerly a member of the 506th Infantry Regiment of the 198th Infantry Division.]

[PW] Sudarev saw German prisoners of war and deserters at his regimental CP . . . in June of this year [1943]. He personally attended the interrogation of two German prisoners. These particular prisoners and deserters belonged to the 121st Infantry Division. At regimental and divisional level, prisoners and deserters are briefly interrogated. On the same day, they are sent on to army where the detailed interrogation takes place. Until they reach army level, prisoners and deserters are not separated. They receive the same rations as the Russian soldiers. Treatment of German prisoners by Russian officers and enlisted men up to army level is allegedly good. They are permitted to retain insignia of rank, decorations, and personal property. Sudarev did not witness the mistreatment or shooting of German prisoners of war and claims that such excesses do not occur. . . .

Questions about German Prisoners of War

[Note: When Russian prisoners were questioned about treatment of German prisoners by the Russians, they practically always emphasized the fact that the Germans were treated humanely -- an understandable response!]

*Source: Interrogation Report, dtd 19 Oct 43, and Interrogation Report, dtd 2 Oct 43, in G-2 file of Army Group North, Ic/AO, Kgf.-Vernehmungen 1, 26.VIII.-32.XII.43.

SECRET SECURITY INFORMATION

Appendix VI
Item 7
Page 1

SECRET SECURITY INFORMATION

[PW] Bogdanov saw . . . approximately ten German prisoners of war in February of this year [1943]. The [capturing] units took the prisoners immediately to division, where they were questioned for the most part in the presence of the division commander. He [PW] attended several interrogations. During the interrogation, treatment is not bad. Cigarettes are offered; the prisoners are permitted to sit and are immediately given something to eat. Interrogations last at least three hours. During such interrogations, questions are asked concerning, among other things, the [German] reaction to Russian leaflet propaganda and the morale and food situation in Germany. In most instances, German prisoners give only little information and reply mostly with: "I don't know." All prisoners which Bogdanov saw made a very good impression on him. Bogdanov states that he does not know of any pressure having been applied in order to increase the prisoners' willingness to testify. The prisoners are subsequently sent on to army where further interrogation takes place. Wounded prisoners are allegedly admitted to hospitals where they are kept separate from the Russians. The same holds true for sick prisoners. Bogdanov heard nothing about the shooting of German prisoners. . . .

Appendix VI
Item 7
Page 2.

52

SECRET SECURITY INFORMATION

SECRET SECURITY INFORMATION

Item 8*

Treatment of a Captured Auxiliary Russian National serving the Germans by the Russians

[Note: The subject of this report was deserter Mustafajev, formerly a member of the 7th Independent Penal Company, 153rd Infantry Replacement and Training Regiment. Mustafajev, who had served the Germans as an auxiliary, was captured by the Russians, but managed to escape to the German lines.]

[The auxiliary was interrogated by the Special Section. The German prisoner had apparently been questioned as to whether the auxiliary had mistreated Russian prisoners; in any event, the interrogator put on a "show of knowledge." During his evacuation to corps headquarters and upon his arrival, the auxiliary was repeatedly beaten. Here he was again interrogated, confined to a cell, and finally assigned to a penal company.]

When [German] Corporal Kruse of the 1st Company, 552d Infantry Regiment, and the subject of this report [auxiliary Mustafajev] were captured by a Russian patrol in front of the German MIR, they were immediately gagged and their hands tied behind their backs. After they had returned to the Russian MIR, they were immediately taken to the CP of the 200th Infantry Division. Five officers, under the command of a major in the Intelligence Service, received them in a bunker with shouts of joy about the successful patrolling mission.

Corporal Kruse had to place his personal belongings on the table: one watch, three lighters, money, and a pistol. The major

*Source: Interrogation Report, dtd 22 Jan 44, in G-2 File of Army Group North, Ic/ aO, Gefangenen-Vernehmungen, 15.XII.43 - 6.III.44

Appendix VI
Item 8
Page 1

SECRET SECURITY INFORMATION

SECRET SECURITY INFORMATION

appropriated the watch, one lighter, and the money. The remaining items also disappeared immediately. Then the two prisoners were asked a few brief questions. Cpl. Kruse was asked about his unit and the auxiliary was examined in order to ascertain whether he wore the sleeve insignia of the "Vlassovzy." He was asked whether he belonged to them. During this questioning, the major repeatedly slapped his face, saying at the same time that he would not beat the German soldier, because he could not be held responsible for having to fight.

Then, white bread, a piece of bacon, hard tack, half a pail of soup, and two cigarettes were brought in. During the meal, the two prisoners were permitted to talk to each other. Again the auxiliary was accused of being a Vlassovez /Vlassov man/. The major then asked the auxiliary how long the German Wehrmacht intended to fight. Subsequently, the major led the two prisoners before the division commander. The general asked: "Are both of them Krauts? . . . Turning to the auxiliary/ "Ah, you have become a turncoat; you cannot even be recognized." The two men were then deprived of their winter camouflage suits and mention was made of the fact that the suits would be useful to the /Russian/ troops in future operations. The general then turned to the subject of this report: "How did you bring yourself to betraying your mother country? . . . So, you have become a Dobrovolez /Volunteer?/" "Yes." "How many prisoners are over there? Why did you not desert to the partisans or to the Red Army? So, you were a Vlassovez.

SECRET SECURITY INFORMATION**SECRET SECURITY INFORMATION**

Did you ever see him /General Vlassov/? Will the Germans continue to fight? How is their food situation? How about their transportation? Have you been able to ascertain anything? Do they get mail or don't they? What do you think about Berlin? Has 30 per cent of the town been destroyed by bombs? Do you know Berlin well? Do you know that there was a conference in Iran? And how does Hitler feel with his troops being surrounded?

Subject replied that he had served with the train and had no knowledge of all these things. Deserting was not a very simple matter.

"In other words, you only worked /for the Germans/. Hm. Hm. . . . You may smoke."

Then the auxiliary was taken to the "Special Section" and did not see the captured German soldier again. . . .

SECRET SECURITY INFORMATION

SECRET SECURITY INFORMATION

Item 9*

[Note: The deponents, Pvt. Wilhelm Huizenga and Pfc. Wilhelm Schwerdt, had been captured by the Russians and had returned to the German lines. A letter of transmittal by the G-2 Section of the 294th Infantry Division states that the two soldiers returned with an espionage mission and that the depositions reveal their having committed high treason. As shown in the depositions, the two soldiers were confronted with each other's stories by the investigating officer, and several discrepancies were found. Since the two soldiers had formerly held Dutch and Polish citizenship, respectively, it appears that their loyalty was considered very doubtful. The final disposition of the case is not indicated in the document, aside from the fact that the two soldiers were turned over to corps.]

Deposition of Wilhelm Huizenga:

... We did not resist at the time of capture. We were immediately disarmed; all utilitarian articles and valuables were taken away from us, and we were stripped of our fur vests and drawers. I retained my identification tag for the time being. Then we were transported to the nearest locality and taken before an officer (lieutenant). The latter called for two additional officers and a commissar holding the rank of a captain (Commissar Severt). We were questioned about the artillery of the "Doghead" and "Shamrock" Divisions and also about the number of vehicles [in these divisions]. When I was asked to name my unit, I complied. I was asked about my regimental commander, whom I did not know. When questioned about the morale [of the Germans], I stated that it was good. I furnished information on ration allowances to the extent that they were known to me. I made these statements without compulsion. As to my

Source: Depositions, dtd 20 Jan 43, in G-2 File of 294th Infantry Division, Anlagen zum Taetigkeitsbericht, Abt. Ic, Anlageband I, 29.XII.42 - 24.I.43.

56

Appendix VI
Item 9
Page 1

SECRET SECURITY INFORMATION

SECRET SECURITY INFORMATION

nationality, I stated that I was a German and concealed my former Dutch citizenship.

[Comment of officer taking Huizenga's deposition] When exception was taken to this statement, Huizenga denied that he had informed the Russians of his former Dutch nationality.

The soldiers of German nationality were evacuated further to the rear, whereas a former Pole and I stayed with the Russians. The Pole spoke perfect Russian. The commissar then told us that German soldiers holding the rank of sergeant and above would be shot. Lower-ranking soldiers would be evacuated to the rear to perform labor. After approximately one to one and a half hours, two additional prisoners were brought into our room. One of them was a 1st lieutenant, whose exact name I cannot recall - I believe it was Balling - and the other was a private. Both were members of a Luftwaffe construction battalion. According to their statements, both had removed their own rank insignia. These two members of the Wehrmacht were also interrogated individually. Later, two more prisoners were brought in, among them the private first class named Willi [Pfc. Wilhelm Schwerdt], with whom I was later sent back to the German lines. This pfc. was from Katowice and was later called "Polski" by the Russians, a fact which made me assume that he had formerly been a Pole. After we had spent the night in another building, the next morning . . . saw us marching south under escort together with the infantry. . . . On 18 January, at noon, seven of the prisoners . . . were separated [from our shipment]

57

Appendix VI
Item 9
Page 2

SECRET SECURITY INFORMATION

SECRET SECURITY INFORMATION

and evacuated. Pfc. Willi and I were held back. I was called to the commissar and was requested to write a letter to my comrades-in-arms. Its contents was to be something like this: "Dear comrades! I am a prisoner of the Russians. I am faring very well indeed. Food and drink are good. Treatment by the Russian officers was not as bad as you were always told. I am not sorry that I have become a prisoner of the Russians. Surrender if you can, and the war will be over for you." This letter was read to me. At first I refused to write this letter and was sent back to my room. Shortly thereafter, Pfc. Willi, who had remained in the officers' room, returned to me in order to take me to the commissar. When I asked him what I should do, Pfc. Willi said that I had to write the letter; otherwise I would be shot. When I came to the room, I wrote the letter and signed it with my full name. Below that I added: "Read and pass on." I had to write this letter ten times. Pfc. Willi took those letters without voicing any objections. I had the impression that he knew what to do with them. When I asked him to what use these letters were to be put, he told me that I should not talk so much and that we would go back to the German lines that night. . . .

The deposition states further that the two soldiers were taken to a senior Russian officer, who had a talk with Pfc. Willi. Shortly thereafter, they were taken to the bank of the Donets and issued a rifle each but no ammunition. The German lines were pointed out to them, and once they arrived there they identified themselves as

Appendix VI
Item 9
Page 3

58

SECRET SECURITY INFORMATION

SECRET SECURITY INFORMATION

German soldiers. Questioned about the letters, Huizenga reiterated that he had followed Willi Schwerdt's instructions for fear of being shot. He also stated that Schwerdt and not the commissar had acquainted him with the mission of crossing over to the German lines. When confronted with Schwerdt, Huizenga denied that the commissar had entrusted him with an espionage mission and stated that Schwerdt had informed him of the mission.

Deposition of Wilhelm Schwerdt:

. . . When I stepped out of the house, I was taken prisoner by the Russians. Although I had a weapon, I did not make use of it but let myself be captured without offering resistance. I was taken in a car to a German-speaking officer - I believe he was a captain - who interrogated me. My papers were taken away from me. I was asked about my unit and gave the number of my division. When asked about the morale of the German troops, I said that it was not particularly good. To a question about frostbite, I replied that its incidence was not very great. I could not furnish any information about artillery. I reported the strength of our company as ninety men. As for the adjacent units, I possessed no information. I was asked whether officers known to me were among my eight fellow prisoners, and I replied in the negative. I described the food situation as very good. We were then taken before a commissar, who asked the same questions. One day, I was again called before the commissar, since I speak a little Russian. He requested me to cross

Appendix VI
Item 9
Page 4

SECRET SECURITY INFORMATION

SECRET SECURITY INFORMATION

over to the German lines and return after I had reconnoitered the German units in that sector. I accepted this mission. Pvt. Huizenga was asked the same question, and he, too, declared himself willing to carry out the mission. Thereupon we were given a warm meal. The other prisoners were fed in the same manner. We were requested to write a letter to the German soldiers. I refused because of my poor handwriting. Huizenga immediately complied with this request. He wrote ten letters with a pencil and later two additional ones with ink. I took these letters, having been charged by the commissar to distribute them among my German comrades. We . . . were subsequently taken by two Russian soldiers . . . to a captain, who gave us more detailed instructions regarding our way to the German lines.

Schwerdt's account of the line-crossing agrees substantially with that of Huizenga. The latter, according to Schwerdt, burnt the letters behind the German lines. When confronted with Huizenga, Schwerdt again admitted to having accepted the espionage mission. His advice to Huizenga with regard to writing the letters had been: "It's up to you." When writing the final two letters with ink, Huizenga was asked whether he wanted to participate in the espionage mission and replied in the affirmative. The deposition also brings out that Schwerdt's name was formerly Schweda and that he was a Polish citizen. He is alleged to have concealed the former and to have denied the latter fact while testifying, for purposes of the deposition. The concluding paragraph of the latter contains a reiteration of Schwerdt's denial to have advised the writing of the letters.]

SECRET SECURITY INFORMATION

Appendix VI
Item 9
Page 5

SECRET SECURITY INFORMATION

Item 10 *

[Note: The two deponents, Pfc. Simon Mayr and Pfc. Bruno Bittner, had escaped from Russian captivity and were required to record their experiences.]

Depositions of Pfc. Simon Mayr:

. . . I was surrounded on all sides. Fourteen Russians pounced on me, hit me in the neck three times with rifle butts, and robbed me of my personal possessions (wrist watch, comb, mirror, etc.). Four or five of them led me to an officer, who took my paybook, knife, field cap, and gloves, away from me. . . . One guard marched me to West Potapov. Enroute, passing Russians kicked me . . . and jeered at me, saying things such as "Hitler kaput." In West Potapov I was locked into a cellar for the time being. Here I met my buddy, Pfc. Bittner, again. Two guards were posted before the cellar door.

After about an hour and a half, we were taken from the cellar, and interrogated individually in a room. (Battalion CP?) The interrogation was conducted by an interpreter, a commissar, and two officers. The interpreter spoke good German and did not have the characteristics of a Jew.

*Source: Deposition, dtd 22 Jan 43, and Deposition, dtd 29 Jan 43, in G-2 File of 62d Infantry Division, Abt 1 C, Tätigkeitsbericht mit Anlagen, I.VII.42 - 28.II.43.

Appendix VI
Item 10
Page 1

SECRET SECURITY INFORMATION

SECRET SECURITY INFORMATION

over to the German lines and return after I had reconnoitered the German units in that sector. I accepted this mission. Pvt. Huizenga was asked the same question, and he, too, declared himself willing to carry out the mission. Thereupon we were given a warm meal. The other prisoners were fed in the same manner. We were requested to write a letter to the German soldiers. I refused because of my poor handwriting. Huizenga immediately complied with this request. He wrote ten letters with a pencil and later two additional ones with ink. I took these letters, having been charged by the commissar to distribute them among my German comrades. We . . . were subsequently taken by two Russian soldiers . . . to a captain, who gave us more detailed instructions regarding our way to the German lines.

Schwerdt's account of the line-crossing agrees substantially with that of Huizenga. The latter, according to Schwerdt, burnt the letters behind the German lines. When confronted with Huizenga, Schwerdt again admitted to having accepted the espionage mission. His advice to Huizenga with regard to writing the letters had been: "It's up to you." When writing the final two letters with ink, Huizenga was asked whether he wanted to participate in the espionage mission and replied in the affirmative. The deposition also brings out that Schwerdt's name was formerly Schweda and that he was a Polish citizen. He is alleged to have concealed the former and to have denied the latter fact while testifying, for purposes of the deposition. The concluding paragraph of the latter contains a reiteration of Schwerdt's denial to have advised the writing of the letters.]

SECRET SECURITY INFORMATION

Appendix VI
Item 9
Page 5

SECRET SECURITY INFORMATION

Item 10 *

[Note: The two deponents, Pfc. Simon Mayr and Pfc. Bruno Bittner, had escaped from Russian captivity and were required to record their experiences.]

Depositions of Pfc. Simon Mayr:

. . . I was surrounded on all sides. Fourteen Russians pounced on me, hit me in the neck three times with rifle butts, and robbed me of my personal possessions (wrist watch, comb, mirror, etc.). Four or five of them led me to an officer, who took my paybook, knife, field cap, and gloves, away from me. . . . One guard marched me to West Potapov. Enroute, passing Russians kicked me . . . and jeered at me, saying things such as "Hitler keput." In West Potapov I was locked into a cellar for the time being. Here I met my buddy, Pfc. Bittner, again. Two guards were posted before the cellar door.

After about an hour and a half, we were taken from the cellar, and interrogated individually in a room. (Battalion CP?) The interrogation was conducted by an interpreter, a commissar, and two officers. The interpreter spoke good German and did not have the characteristics of a Jew.

*Source: Deposition, dtd 22 Jan 43, and Deposition, dtd 29 Jan 43, in G-2 File of 62d Infantry Division, Abt 1 C, Taktisheitsbericht mit Anlagen, 1.VII.42 - 28.II.43.

Appendix VI
Item 10
Page 1

SECRET SECURITY INFORMATION

SECRET SECURITY INFORMATION

Prior to the interrogation, I was warned by the interrogator approximately as follows: "I call your attention to the fact that you must tell the whole truth. Should we establish the opposite, you will be shot."

The interrogation covered approximately the following questions: Personal data, my regiment, the strength of the company, the names of the commanding officers, and our heavy infantry weapons. Since my answers were misleading and did not appear plausible, they held a pistol against my chest three times during the interrogation. After the interrogation, my money (50.-reichsmarks) as well as the rest of my personal belongings (lighter, flints, etc.) were taken away from me. The interrogation had lasted about half an hour. Thereupon, a guard took me back to the cellar, to which Pfc. Bittner, too, had been confined again.

About noon the next day, a truck took us further to the rear, probably to regimental headquarters. There, four officers interrogated me again along the same lines as before. While they did so they twice held a pistol against my chest. After the interrogation, I was locked with Bittner and another recently added comrade into a cellar. Some time later, a commissar came to look after us. We asked him for food. . . . Later, one of our guards handed us a few spoonfuls of soup and two slices of bread. At 2000, a guard marched us further to the rear. Enroute,

Appendix VI
Item 10
Page 2

62

SECRET SECURITY INFORMATION

SECRET SECURITY INFORMATION

the guard, who spoke some German, told us that we would go to Siberia. Lack of watchfulness on the part of the guard enabled us to communicate with each other, and we decided to gain "liberty or death."

When the guard came as close as one meter, we pounced on him, knocked him unconscious, and fled. . . .

Deponent and his comrades were separated while trying to reach the German lines. Mayr joined a group of isolated Germans, with whom he fought his way back to the German outposts.

Deposition of Pfc. Bruno Bittner:

Note: Bittner made two separate depositions regarding his experiences as a Russian prisoner of war -- on 27 Jan 43 and again on 29 Jan 43. The two depositions, both of which are contained in the original source, agree on all essential points. The second one was more detailed and was therefore selected for inclusion in this appendix. A comparison of Mayr's and Bittner's deposition shows Mayr in a rather unfavorable light. The reaction of the investigating officer may be judged from his concluding remark on Bittner's deposition, in which the latter is described as an upright and soldierly individual.

On the day of my capture . . . I was to relieve a machine gunner Three men in camouflage suits approached me. . . . When they faced me, one of them raised his hands, and it was only then I saw their Russian burp guns. They grabbed me immediately, searched my pockets, and took my cigarettes away. Then they took me to the nearby village (Werch.Potapoff) on the Donets. There I was interrogated by an interpreter and an officer. . . . I was asked what part of Germany I was from and whether my parents were

Appendix VI
Item 10
Page 3

SECRET SECURITY INFORMATION

63

SECRET SECURITY INFORMATION

living. When asked about my company, I answered that I belonged to Company "Schenke." I also told them, upon being asked, the number of my regiment and division. When they wanted to know the name of the division commander, I replied that at first it had been General Keiner and then General von Obstfelder. I claimed that I did not know the names of their successors.

[According to the deponent, further questions dealt with the whereabouts of German soldiers and tanks on the west bank of the Donets, the number of guns, the strength of the complement in the German-occupied village, the armament of the complement, the strength of the squads, and the presence of field fortifications.]

I stated that there were still some old fortifications around. In reply to the question whether there were any bunkers which could be improved on, I said that there were two on the hill which we wanted to fix up as living quarters. They wrote that down immediately. Then they asked about morale. I told them it was not very high at the moment. When they asked me whether any of our men wanted to desert, I told them that I did not know. They also questioned me about our rations, and I told them that we received half a loaf of bread per day, that the mid-day meal was good, and that we got enough to eat. They both replied that Russian soldiers got a whole loaf of bread every day.

My answers were rather vague. . . . The interpreter told me that I would be taken to a prisoner-of-war camp where we would get

SECRET SECURITY INFORMATION**SECRET SECURITY INFORMATION**

enough to eat and to smoke as well as off-duty time and where we would be employed according to our occupations.

The interpreter spoke good German. Before the interrogation they did not threaten to shoot me in case I did not tell the truth. They did not level a pistol against my chest, either. After the questioning, they took my papers, paybook, purse, and watch. We each got a piece of bread.

About 2200, I was taken once more from the cellar in order to bandage two wounded fellow prisoners. I don't know who they were. Mayr and Cpl. Braun were in the cellar with me. We then slept until morning. At 0600, we and the two wounded prisoners were put on a truck and driven twenty kilometers due east to the rear. Before we left, we were told that we would be shot if we made an attempt to escape. We were then taken to another command post, apparently a regimental headquarters. There we were again interrogated by an interpreter, a captain, and several commissars. The questions were the same as before. I gave the same answers. Afterwards, we were again locked into a cellar, given straw to lie on, a container of cabbage soup and meat for the three of us, and plenty of bread.

[Later, a commissar came down to see them and talked to the corporal who knew some Russian. Subsequently, the commissar left, only to return and shout an obscene threat.]

We then slept again until evening. About 2000, a Ukrainian guard -- who said he was from Charkov -- came to get us. He marched us seven kilometers south to a locality from where we were to be

SECRET SECURITY INFORMATION

SECRET SECURITY INFORMATION

sent to the prisoner-of-war camp. Shortly before reaching the village, we conspired to slug the guard. We let him come a little closer and engaged him in conversation. On a previously arranged signal, Braun and I knocked him down. Mayr stood passively by. When we told him to help us -- he could see what was at stake -- he said that he was unable to do anything like that. We messed up the guard pretty badly and wanted to take his pistol too. Then two trucks appeared with their headlights on, so that we had to flee. . . . I parted from the other two I thought it a better idea to take a trail west which was bound to lead me to the Donets. It is not true that we were pursued and dispersed by Russians. Without having met a single Russian, I crossed the Donets about 0900. I went into the woods there and then to a village where I met German troops. . . .

I was not asked whether I was willing to return to the German lines in order to encourage my comrades to desert. Neither was I asked to sign any kind of document. I was neither mistreated nor threatened with death. . . .

Appendix VI
Item 10
Page 6

66

SECRET SECURITY INFORMATION

SECRET SECURITY INFORMATION

Item 11 *

[Deposition of Pfc. Johann Kolodziejczyk who had escaped from Soviet captivity.];

. . . . On 6 August 1943, I became a Russian prisoner. . . . First, they took my rifle and belt and brought me to the command post in Koshelevo. There they stole all my belongings including my wallet, dogtags, and boots. They gave me a wornout pair of boots in return. They also ripped the wound, cavalry, and national emblems from my blouse as well as my shoulder straps. From Koshelevo they brought me to a command post in the fields. On the way to the CP, a general stopped me and asked some questions. At the CP an officer hit me repeatedly because I could not answer him and did not understand his Russian questions. I was there for only a short time, but on my way there several Russian soldiers tried to attack me, and only the protection of my guard saved me from being completely beaten. From the CP, they brought me to a village where I was interrogated by an interpreter who was perhaps a Jew. He asked me the following questions: What was my organization? How was our morale? Why was I fighting? How was our food? How was our fighting spirit? Did we know the Russians had recaptured Orel? What had I seen in Prvansh? How long had I been a soldier? What was in the conversations between officers

*Source: Deposition, dtd 9 Aug 43, in 102^d Infantry Division File, GMDS #37 539/B.

Appendix VI
Item 11
Page 1

67

SECRET SECURITY INFORMATION

SECRET SECURITY INFORMATION

and enlisted men? Was there enough bread? What do we know about the fate of Mussolini?

Personal questions about my life and goings were asked by young women who also prepared the food. They were uniformed as officers. They asked me to go back to the German lines and give propaganda talks so that more Germans would desert. I refused. After the interrogation I was locked in an earthen shelter.

I was interrogated once more in the evening and told that other PW's had given more details. Once more they asked me to give more details. There was another German prisoner in the cellar with me, but I do not know his organization. In the afternoon, four German prisoners who had been in the cellar were led off to a prison camp. I managed to escape because during the night the guard fell asleep. . . .

Appendix VI
Item 11
Page 2

68

SECRET SECURITY INFORMATION

SECRET SECURITY INFORMATION

Item 12*

[Note: The subjects of this report are Capt. Krinsky, formerly interpreter with the G-2 Section of the 318th Infantry Division, and Major Menshov, formerly operations officer (G-3) of the 318th Infantry Division.]

Prisoner of War Set-Up

The interrogation of prisoners of war is handled by the following:

1. The intelligence officer whose questions deal with tactical and O/B information in order to obtain a clearer picture of the current enemy situation.

2. The political Section which asks questions concerning economics and politics, morale, discipline, treatment of prisoners of war, etc.

[Depending upon the significance of the prisoner's testimony, he is sent to the division, corps, or army group intelligence officer. The intelligence officer, however, has no influence on the future destiny of the prisoner of war beyond the opportunity of making an entry in the prisoner's dossier (protocol). After the intelligence officer and the political section have completed their interrogations, the prisoner is handed over to the NKVD.]

* Source: Consolidated Interrogation Report, sts 16 Dec 13, in G-2 File of Seventeenth Army, Beilage 1 zum K.T.B. Nr. 8, Anlage V (Ic Gefangenenvern), 10.X. - 31.XII.43.

Appendix VI
Item 12
Page 1

69

SECRET SECURITY INFORMATION

SECRET SECURITY INFORMATION

3. The NKVD interrogates him about German armament and war potential as well as intelligence matters and considers his possible usefulness for intelligence work. The NKVD interrogators then decides what final disposition is to be made of the prisoner.

The political interrogation always begins with the question: "Why are you fighting against a nation of workers and peasants?" Treatment varies with the prisoner's willingness to testify. Pressure methods are also used, (starvation, beatings). Prisoners of war are employed in road construction, the rebuilding of Stalingrad, etc. They receive sufficient rations; deserters get more. Many of the guards are Romanian and Slovak deserters who treat the Germans badly. In the Russian rear areas, many German prisoners of war (probably deserters) work unguarded and are quartered in civilian homes.

Because of the disproportionate ratio in the numbers of captured enlisted men and officers, the government stresses the importance of sending captured German officers to officer prisoner-of-war camps.

Appendix VI
Item 12
Page 2

70

SECRET SECURITY INFORMATION**SECRET SECURITY INFORMATION**

Item 13*

In mid-March 1947, the Subject (German lieutenant) was taken prisoner by the Russians in Silesia. He was escorted with two other German officers. . . . to a village where they were interrogated by the Russians. A captain P--- was the interrogator. . . . During the course of his interrogation, the Subject was shown a propaganda leaflet written in German which he criticized as not being of the right composition to appeal to the German mentality. This appeared to interest the interrogator who later told him that he could choose between a prisoner camp or helping the Russians with their propaganda. After short consideration, Subject accepted the second alternative. . . . His first assignment was broadcasting by loud speaker from a truck. . . . Next he worked about two weeks producing propaganda leaflets. . . . then he went back to the truck. [Subject was later sent to an "antifa" school and became a Soviet agent in the American zone of occupation in Germany.]

* Source: EUCOM, ID, Interorganization Rpt, dtd 12 Apr 47,
Re: MGE Operational Techniques, (TS), p 10. [Date of
information, March 1945].

Appendix VI
Item 13

SECRET SECURITY INFORMATION

SECRET SECURITY INFORMATION

Item 14*

[Note: Source was a prisoner in the USSR from 1945 to 1947 and was last in an MVD prison in Leningrad. This is an excerpt from the report.]

Interrogations were carried out at night just after the prisoners had gone to sleep. The interrogation rooms were on the ground floor of the prison, and if anyone was met in the corridor while going there, the prisoner was obliged to stand facing the wall until the other person had passed.

As long as source was in the prison, he never saw or heard anything about atrocities. He states that sometimes the interrogator slapped a man across the face or kicked him, but this treatment was considered legal.

The interrogator sometimes threatened source that he would be shot immediately if he did not say or write what was wanted, but most of the time the interrogator was rather courteous. According to source, the lack of rest, the monotony of the questions which were repeated over and over again, and above all the intense hunger were sufficient to break the strongest man, if he had anything at all to say. Those men who had weaker nerves often signed statements which were absolutely false so as to be left alone. In very difficult cases, when a man resisted, he was placed in solitary confinement in a dark

* Source: 7707 ECIC, Rpt RT - 494 - 50(CI - 986), dtd 17 May 50, sub: MVD Prison in Leningrad, USSR, (S). [Date of information, July 1947].

SECRET SECURITY INFORMATION

SECRET SECURITY INFORMATION

cell and was kept there until he confessed, or until he signed any statement the MVD required.

Interrogators often kept the prisoners waiting for long periods before interrogating. One of the source's cell mates had waited two hundred days before he was called in. . . . The chief interrogator for German prisoners was MVD Major R---, an Estonian by birth. . . . He told source that he had been in jail for four years in England on an espionage charge. He speaks fluent German and source supposes that he speaks English, French, and Estonian.

SECRET SECURITY INFORMATION

SECRET SECURITY INFORMATION

Item 15 *

In their interrogations, the Soviets usually followed the practice of taking the defendant unawares: If they wanted to extort a confession, the accused was roused from his sleep after a hard day of work rushed to the interrogation room, and accused point blank of some crime. This procedure would be repeated for several nights in succession, and after weeks and months had passed the whole procedure would be re-enacted. Threats and tempting offers of freedom were alternately used as well as requests for signed statements denouncing others. A single small contradiction in testimony taken during several months' time, or even a year, was regarded as prima facie evidence of guilt. Sentences of several years were customarily given for minor offences. Russian civilians were punished the same way -- when a PW was convicted, he lost his status as a PW for the duration of his sentence and was immediately transferred to a Russian civilian convict labor camp. . . .

*Source: 7001st AISS, USAFE, Air Historical Research Information Reports, dtd 13 Dec 48, sub: Soviet Treatments of German PW's pers. g.

Appendix VI
Item 15

74

SECRET SECURITY INFORMATION

SECRET SECURITY INFORMATION

Item 16 *

SS men reported extremely severe and cruel methods of interrogation employed by the Soviets during the first two years of the war. They were required to work at exhausting tasks; and when they had gone to bed and were asleep, they were awakened for interrogation. They were often subjected to extreme cold, bright lights, damp collars, and other such conditions which tend to crack a man's moral fiber. They were often slapped, kicked in the genital organs, struck with the butts of rifles, and threatened with death. This process continued for a week, a month, and sometimes almost a year. At length a confession was prepared in Russian and the PW's were asked to sign it. A translation of the document was denied. The Russians would ask the PW about the number of Russians he had killed, the number of bridges he had destroyed, or the number of domestic animals that he had slaughtered. The Russians attempted to convict the PW of issuing, forwarding, or carrying out orders with which Russian partisans or civilians were forcibly evacuated or deported, shot to death, or raped, or by which buildings were burned, railroad lines, agricultural areas, livestock, food, and everyday articles of the Russian civilians were destroyed.

*Source: 7001st AISS - USAFE, Air Intelligence Information Report No. 1C-172-1, 10 Jan 1950. sub: Treatment of PW's in the USSR (S) 10 Jan 1950 [Date of information; 1945 - 9. Based on 230 interrogations by 6 interrogators.]

Appendix VI
Item 16

75

SECRET SECURITY INFORMATION

SECRET SECURITY INFORMATION

Item 17 *

Almost 100 per cent of the prisoners were interrogated by the Soviet MVD personnel. The interrogations chiefly concerned military and political background, committed war crimes, such as setting fire to villages during combat action, fighting against guerrillas, displacing of the population, guarding the Soviet PW's, etc. There was in addition, a close check for members of the SS, rear-areas [military government] headquarters and other special former Wehrmacht units. The majority of the PW's noted the following predominant interrogation methods; threatening with guns; beating; food reduction; false promises; imprisonment; transferring to slave labor camps* and collecting of information by spies infiltrated into the PW camps or by fellow PW's forced to spy on their comrades.

*Source: Team 12, OSI, IG, USAFE, Positive Intelligence Report No. 12-199-0250, dtd 20 Feb 50, sub: Russian Treatment and Interrogation of German PW's, (S).

Appendix VI
Item 17

SECRET SECURITY INFORMATION

76

SECRET SECURITY INFORMATION

Item 18*

2. General: A study of individual reports given by returned German PW's about their treatment by the USSR while in Soviet PW camps reveals a general uniformity in some respects in spite of differences in conditions among various camps. First, living conditions improved, particularly after 1949, insofar as food was concerned. In most cases, the returned PW's said that, beginning in 1949, they were able to purchase additional food; shelter improved if the PW's improved their own quarters. Second, there was a general scarcity of clothing for PW's during their internment. Third, medical treatment suffered because of the lack of sufficient medicines. Fourth, working conditions were described as bad because of the high quota of production required from each prisoner. Fifth, all PW's were given "antifa" indoctrination either twice or three times a week. (Anti-American indoctrination was given in some camps and not in others.) Sixth, arrests of PW's were frequent and arrest without food appears to have been commonly employed; mistreatment of PW's by threats, with pistols, or by beatings were cited frequently by those furnishing information for this report. Seventh, interrogation by the Soviets was said to have been conducted mainly at night.

* Source: Team 15, 7020 AF CI Unit, USAFE, Positive Intelligence Report No. 15-179-250, sub: Russian Treatment and Interrogation of German PW's, (S).

SECRET SECURITY INFORMATION

Appendix VI
Item 18
Page 1

77

SECRET SECURITY INFORMATION

at different hours, with cross-interrogation of different PW's in the same camp. . . .

g. Interrogation Methods Employed by the Soviet:

(1) The returned PW's were in agreement that interrogations were held at night at different hours. One source, from POW Camp No. 7125/4 at Proletarsk, however, described interrogations as lasting "weeks and weeks" with threats of imprisonment in Siberia. Threats with pistols were frequently referred to by returned PW's as were arrest without food.

(2) Source from [two different camps]. . . reported that mistreatment of PW's had occurred during interrogation and that beatings had been administered. According to one source, former SS men were sent to a PW camp near Tbilisi . . . but he was unable to give this camp's exact location.

(3) One interrogation method . . . was the practice of having a PW released and started on his way home. At the second railroad station, the PW would be picked up by Soviet police, returned to the prison, and reinterrogated. This same source described the slapping of interogatees by hand and with a stick during some interrogations.

Appendix VI
Item 18
Page 2

SECRET SECURITY INFORMATION

Item 19*

In many instances threats or actual physical violence were used during interrogation. The military background and political background of prisoners were favorite subjects of interrogation. Some prisoners were interrogated as many as thirty times over a long period of time. During these interrogations, information on activities of German military units in the USSR during the war was a primary subject. Information leading to evidence of a war crime committed in the USSR was followed through thoroughly. Many ordinary prisoners were not interrogated at all. In compiling the information given by a prisoner, it is apparent that the Soviets had no standard methods of interrogation. Soviet interrogators seemed to use methods best suited to gain the desired information, and went to all extremes to gain the information.

* Source: Team 6, 7020 JFCI Unit, USJFE, Positive Intelligence Report No. 6 - 137 - 0250, dtd Feb 50, sub: Russian Treatment and Interrogation of German POW's, (S). [Date of information, 1944-9].

Appendix VI
Item 19

SECRET SECURITY INFORMATION

Item 20 *

... Source was taken to the MVD headquarters to be interrogated shortly prior to his release in 1949. Source later deduced that this interrogation was conducted to establish what connection, if any, source's work had with espionage activities behind the Russian lines. . . .

The Russian interrogator started by asking source what unit and service he had been with during the war. . . . He then asked him how many Morse code letters source could take down. . . . The interrogator then spent the next hour asking him about how Germans intercepted Russian radio traffic, how they located Russian transmitters, and questions about wave lengths of German equipment. . . . Source became aware that the Russians's technical qualifications were very limited, but he also sensed that this was not the reason for the interview. Eventually, the Russian wanted to know, casually, if source had made contact with clandestine transmitters behind the Russian lines. Source denied this, stating that he believed that another section of his unit was charged with this responsibility. . . . The interrogator appeared to be rather annoyed over his failure to secure an admission that source participated in this service, but did not

*Source: 7001 Air Intelligence Su Sq, Air Historical Research Information Report No. T-008042-4-511C, Jan 19, (S).

Appendix VI
Item 20
Page 1

80

SECRET SECURITY INFORMATION

SECRET SECURITY INFORMATION

threaten him nor use brutality against him. Source was returned to camp after four hours.

Source stated that he considered himself to be very fortunate in having been interrogated under these circumstances. He said that normally interrogation took place in the PW camp and was conducted by the camp commissar, or by some visiting commission. Whenever the Russians were faced with a denial by a subject during these interrogations, they would use brutality which in some instances, involved hitting the subject's face with a pistol butt. If no admission was secured in this fashion, then the German would be subjected to unmerciful interrogation techniques which included solitary confinement in cold and wet bunkers, etc. When the German eventually decided to make an admission, merely to be rid of this "special attention," the treatment was intensified instead, evidently on the theory that if he would admit one thing, further attention would make him tell other things. Such an interrogation ended up with the subject being totally broken. Source reported one such instance in which the German admitted nothing, was finally given a glass of vodka, patted on the back, and given an offer from the MVD to work for them as a stool pigeon.

[From paragraph 7: Comment] It should be noted that the source was interrogated on his military duties after four years had elapsed. That the intent of the interrogation was not to

Appendix VI
Item 20
Page 2

81

SECRET SECURITY INFORMATION

SECRET SECURITY INFORMATION

Item 20 *

. . . Source was taken to the MVD headquarters to be interrogated shortly prior to his release in 1949. Source later deduced that this interrogation was conducted to establish what connection, if any, source's work had with espionage activities behind the Russian lines. . . .

The Russian interrogator started by asking source what unit and service he had been with during the war. . . . He then asked him how many Morse code letters source could take down. . . . The interrogator then spent the next hour asking him about how Germans intercepted Russian radio traffic, how they located Russian transmitters, and questions about wave lengths of German equipment. . . . Source became aware that the Russians's technical qualifications were very limited, but he also sensed that this was not the reason for the interview. Eventually, the Russian wanted to know, casually, if source had made contact with clandestine transmitters behind the Russian lines. Source denied this, stating that he believed that another section of his unit was charged with this responsibility. . . . The interrogator appeared to be rather annoyed over his failure to secure an admission that source participated in this service, but did not

*Source: 7001 Air Intelligence Sq, Air Historical Research Information Report No. T-008042-4-511C, Jan 49, (S).

Appendix VI
Item 20
Page 1

SECRET SECURITY INFORMATION

SECRET SECURITY INFORMATION

threaten him nor use brutality against him. Source was returned to camp after four hours.

Source stated that he considered himself to be very fortunate in having been interrogated under these circumstances. He said that normally interrogation took place in the PW camp and was conducted by the camp commissar, or by some visiting commission. Whenever the Russians were faced with a denial by a subject during these interrogations, they would use brutality which in some instances, involved hitting the subject's face with a pistol butt. If no admission was secured in this fashion, then the German would be subjected to unmerciful interrogation techniques which included solitary confinement in cold and wet bunkers, etc. When the German eventually decided to make an admission, merely to be rid of this "special attention," the treatment was intensified instead, evidently on the theory that if he would admit one thing, further attention would make him tell other things. Such an interrogation ended up with the subject being totally broken. Source reported one such instance in which the German admitted nothing, was finally given a glass of vodka, patted on the back, and given an offer from the MVD to work for them as a stool pigeon.

[From paragraph 7: Comment] It should be noted that the source was interrogated on his military duties after four years had elapsed. That the intent of the interrogation was not to

Appendix VI
Item 20
Page 2

SECRET SECURITY INFORMATION

SECRET SECURITY INFORMATION

produce military information but to produce evidence which could be used to punish source and/or others for intelligence work which was a normal duty for the individual. From comments by the source on the experiences by others, it is also apparent that refusal to talk in many cases resulted in mistreatment, a recognition by the Russian interrogator of his inability to handle the subject, and that any admission after mistreatment resulted only in further beatings, solitary confinement, etc., evidently on the theory that if one action produced results, continued brutality would produce further information.

Appendix VI
Item 20
Page 3

82

SECRET SECURITY INFORMATION**SECRET SECURITY INFORMATION**Item 21 *

[Note: Source, a former sergeant in the SS, was captured by the Russians on 6 Feb 1945. He shot away an SS tattoo mark before capture but was suspected by the Russians of having been a member of the SS].

... Early in 1947, Source was summoned to the MVD office in Kiev which was located in the university lecture section. There he was told that he was suspected of being a member or officer of the SS by other prisoners. Until October 1947, source was interrogated approximately sixteen times, usually between 2000 and 0400. He was mainly cross-examined by three or four interrogators. After entering the room, source usually had to wear a furcoat and sit down beside a hot stove. Then he was asked to confess that he had been an SS officer and told that there would be enough witnesses to prove this fact. Scholz always asked to be confronted with these witnesses but never was. He was also very often beaten with wooden sticks and struck over the head with gun stocks. During the day, he had to work as usual. Despite this treatment, source never confessed being a member of the SS.

In October 1947, source was transferred to a PW camp . . . in Staling where he was employed in a canteen until . . . in 1948,

*Source: Team 4, OSI, IG, USAF, Positive Intelligence Report No. 4-295-0350. 9 March 50.

Appendix VI
Item 21
Page 1

83

SECRET SECURITY INFORMATION

SECRET SECURITY INFORMATION

new interrogation by MVD, which was located beside the camp, started. Here he was again interrogated three times in the same manner as in Kiev. After these interrogations, he was called in once more, in May 1948, to meet a Russian MVD General, who had been sent from Moscow with six more interrogators. Source was treated in the usual way. This interrogation had to be broken up several times when source fainted due to severe beatings. At this interrogation, source was shown his "Kehrpas" which the Russians had secured in Breslau. It carried his picture as well as his signature and information concerning his service. [Source had falsified his name and unit on capture.] Source still denied that he had been a member of the SS. After the interrogation, source was taken to the camp and thrown into the cellar on a concrete floor. It was strictly forbidden to give him any food or medical care. Despite this order, the commander of the camp brought him some food. . . . He also received some medical care consisting principally of injections. Source lived like this for a period of three weeks. During this time, source was visited by MVD agents or officers every night, awakened, and questioned again. After this, source remained in the camp for four days and then started to work again in the coal mine. . . .

Appendix VI
Item 21
Page 2

84

SECRET SECURITY INFORMATION

SECRET SECURITY INFORMATION

Item 22 *

1. German PW's repatriated during the last months of 1949 report that in September and October 1949 MVD men not belonging to the PW camps arrived with lists of German PW's who at one time were members of units accused of atrocities on Soviet territory. These PW's were then subjected to protracted interrogations.
2. Interrogations took place during the night in order that the PW's output should not be lost during the working day. The procedure during interrogations varied from a correct approach to acts of sheer brutality. The following are examples of the latter:

a. At one camp, PW's were offered cigarettes. When they went to accept one, the cigarette boxes were slammed shut, cutting the PW's fingers to the bone. The interrogation continued with the PW's fingers still jammed in the box.

b. A PW was squeezed into a cell approximately one and one half meters high which could contain one person only. An electric bulb of 100 watts in the ceiling was switched on. The prisoner was kept in this cell for 10 to 20 hours. When cells of this kind were opened, the prisoner was usually found in an unconscious state and upon being awakened with

*Source: CL Information Report No. SO 38648, Oct 49, sub: Retention of German PW's in the USSR, (S).

Appendix VI
Item 22
Page 1

SECRET SECURITY INFORMATION

SECRET SECURITY INFORMATION

they were immediately interrogated. Thus physically weakened, he usually "confessed" to all of which he was accused. After the prisoner signed the "confession," the MVD interrogators became very pleasant and presented the "guilty" prisoner with food and cigarettes. The trial took place a few weeks later, and the prisoner was sentenced. Sentences ranged from 5 to 15 years of forced labor.

3. The following "crimes" were enough to cause a prisoner to be sentenced:

- a. To have stolen chickens on Soviet territory during the war.
- b. To have been a driver transporting Soviet civilians from east to west.
- c. To have been an interpreter who participated in the interrogations of Soviet prisoners of war.
- d. To have been a "Landesschuetze" (older soldier) guarding Soviet prisoners of war or Soviet territory.
- e. To have fought against Soviet partisans.

4. It is estimated by returning prisoners that by such methods about 25 to 30 per cent of all prisoners of war in these camps were being retained. The prisoners retained after the execution were mainly from the following categories:

- a. SS units
- b. Police and Military Police regiments
- c. Security divisions
- d. The more intelligent prisoners

SECRET SECURITY INFORMATION

SECRET SECURITY INFORMATION

Item 23*

The treatment received by the prisoners in the camps varied. There are very few reports of brutality by foremen on the job, none of them occurring after 1946. The interrogation techniques varied with the camp involved. They were mostly concerned with finding men who had been members of units which were known to the Russians to have been in areas where atrocities had been committed. It seems that the Russians have a theory of collective guilt in such cases; that is, each member of the unit is guilty of any crime which may have been committed. The interrogation resulted from straight denunciations by one prisoner of another. The denunciation was motivated by spite or by a desire to obtain material benefits as a stool pigeon. In such cases, the MVD usually tried to find another prisoner to corroborate the "evidence," and such statements were usually sufficient to insure punishment for the accused. Both the accused and the witness, but not the informant, underwent an interrogation.

In one camp no special efforts were made to intimidate except that the interrogator would get out his pistol, play with it, and lay it on his desk without mentioning it in so many words.

*Source: Air Historical Research Area: USSR, 22 Nov 49 (S)
[Date of information 1944-49].

SECRET SECURITY INFORMATION

SECRET SECURITY INFORMATION

However, some camps had special punishment cells of interrogations. These cells . . . measured sixty centimeters square, and the subject was unable to lie down. Some of these cells contained a layer of water with a couple of stepping stones so that the subject had to stand on them to keep from getting wet and consequently freezing if the temperature happened to be low. At least one instance has been reported where a man froze both feet in such a cell, and his feet had to be amputated. After refusing to admit guilt, or to testify against the accused as desired by the interrogator, the subject would be placed in one of the cells so he would have time to meditate. In this connection it should be noted that those tried and found guilty are removed from the status of prisoners of war and are classified as penal prisoners (Strafgefangene) after sentence. This provides a technicality under which prisoners may be kept indefinitely although Moscow may state that all prisoners of war have been released. There are some hints that this procedure is being utilized to retain needed specialists.

88

Appendix VI
Item 23
Page 2**SECRET SECURITY INFORMATION****SECRET SECURITY INFORMATION**Item 24 -

1. The following information was derived by the interrogation of 200 [returned German] prisoners of war between 1 December 1949 and 10 February 1950.

2. In general, 50 per cent of the prisoners interviewed stated that the treatment received, while they were prisoners of the Russians, was very bad. All of the prisoners stated that they were periodically beaten and mistreated. Food, consisted of 400 grams of bread and 500 grams of soup and meat [daily]. Prisoners received meat on an average of twice a week; this meat was of the worst quality. Shelter consisted of plain wooden bunks without mattresses, and each prisoner received one blanket. Heating of barracks was kept at a minimum, and wood was rationed. . . . In most cases, room temperatures did not exceed 55 degrees. Medical care and treatment was very bad and most camps lacked medical supplies. The German doctors tried their best with the equipment on hand. Many prisoners died from exhaustion, malnutrition, and tuberculosis. Working conditions were unbearable and each prisoner had a quota to meet which was practically impossible on a ten-hour-day schedule. Propaganda against capitalist systems, specifically against the United States, was preached daily for one hour. Ninety per cent of the

*Source: Team 11, 7020 AF CI Unit, USAFE, Positive Intelligence Report No. 11-105-0250, sub: Russian Treatment and Interrogation of German PW's, dtd 10 Feb 50, (S)

Appendix VI
Item 24
Page 1**SECRET SECURITY INFORMATION**

SECRET SECURITY INFORMATION

the prisoners stated that they were not very impressed with the communistic system and were not lightly misled by Russian propogande methods employed. Interrogation methods employed by the Russians were brutal. In many instances prisoners were imprisoned in a cell one meter by one meter; these cells were unheated and victims were unable to stand or to lie down. They were threatened with death until confessions or statements were signed.

3. Ten per cent of the prisoners who were followers and leaders in the Russian camps after attending "Lentife" schools stated that treatment was excellent and that housing facilities included beds, mattresses, and other comforts. Medical facilities were fair, food was plentiful, and working conditions excellent according to these prisoners.

Appendix VI
Item 24
Page 2

SECRET SECURITY INFORMATION

Item 25 *

[Note: Source was an Austrian, a former member of the Wehrmacht who was captured by the Russians in May 1945 and recently discharged from a Russian PW camp.]

. . . The Russians have so called "assistant police" for the camps consisting of previously captured Germans who are selected by the Russians during the war, and they are always . . . among the prisoners in order to spy upon them. They also threaten those prisoners who are to be punished.

All prisoners are required to fill out a questionnaire every time they are transferred to a new camp. The questionnaire consists of about forty questions. Included are: questions on vital statistics, on military service, political affiliations and activities, . . . on individually [owned] property, its extent and nature, and including the possessions of the individual's family. These [questionnaires] are compared; if any discrepancy exists, the prisoner in question is interrogated by a member of the NKVD.

*Source: Hqs USFA, Office of the AC/S G-2, Special Weekly Rpt No. 7, 3 Dec 46, Part II, pp. 15 ff. (TS).

Appendix VI
Item 25

SECRET SECURITY INFORMATION

PART TWO

Item 26 *

[Note: Source was Soviet scientist who had been interned in Soviet prisons and camps for six years.]

[The source] summed up the methods of exerting influence during imprisonment on remand in the Soviet Union under the following four headings:

(a) Exertion of Physical Influence

- (1) Physical maltreatment during cross-examination without assistants.
- (2) Exertion of physical influence by systematic maltreatment with assistants.
- (3) Torture by thirst. Transfer from a cold-air cell into a hot-air cell and visa versa.
- (4) Cross-examination on a "conveyor." Several interrogators cross-examine the person concerned without interruption for ten to fifteen hours.
- (5) Torture with special instruments. Torture with special electric apparatus.
- (6) Threat of hanging or drowning. Partial carrying out of this threat but stoppage of the experiment shortly before death occurs.

*Source: Com Nav For Govt, Intelligence Report, Serial 278-S-19, dtd 6 Jul 49. Evaluation B-3 (S)

Appendix VI
Item 26
Page 1

SECRET SECURITY INFORMATION

SECRET SECURITY INFORMATION

(b) Exertion of Psychic Influence

- (1) Cross-examination under the pretence of an amiable attitude. . . .
- (2) Intimidation of the source by threatening a particularly severe punishment.
- (3) Internment in a cell with the worst criminals.
- (4) Cross-examination by searchlight or in a cell where internees are shot.
- (5) Fictitious shooting of internees.
- (6) Torture by uncertainty in solitary confinement up to fifteen months.

(c) Exertion of Moral Influence

- (1) Discrimination against friends and relatives in order to create hatred among them.
- (2) Threat of arrest of members of families or close friends; in harmless cases -- threat of dismissal from government service.
- (3) Torture of the children in the presence of the parents to obtain the desired statements.

(d) Hypnosis and Narcotics

- (1) individual hypnosis.
- (2) Chlorine Hydrate. Used for breaking down willpower. . .

Appendix VI
Item 26
Page 2

93

SECRET SECURITY INFORMATION

SECRET SECURITY INFORMATION

Item 27 *

[Note: Source was former member of the Comintern]

I had to dwell long, long years in prison cells and in hard labor camps of the Ministry of Internal Affairs [MVD]. And I had to go through most terrible experiences which can be known only by those people who have gone through investigations as state prisoners of Russia. During the investigations -- which lasted almost a year and a half -- I went through all grades of their methods of investigation, including the three grade investigation which includes disgusting physical masterings. [These] are so horrible that all the methods of the Inquisition of the middle ages were just child's play compared with the torture methods of the political police of the MVD of Bolshevik Russia . . .

*Source: Military Attache Report, Moscow, R-251-48, dtd 9 Aug 48, (S).

Appendix VI
Item 27

94

SECRET SECURITY INFORMATION

SECRET SECURITY INFORMATION

Item 28*The Case of Klara Kaufeld, a Sixteen-Year Old Student

[After the Russian occupation of Latvia following the invasion of Poland, this girl joined some of her fellow students in founding a nationally oriented student group. When they were betrayed, she was arrested by the NKVD.]

. . . I was interrogated by an NKVD man. He asked about our group, who has taught us our ideas, and who had turned us against the Soviet Union. I did not answer him. At first he was very friendly with me; later he yelled at me and threatened to lock me up and have me shot. I could hear a fellow student being interrogated in the next room. The NKVD man ordered me to sign a document written in Russian, but I refused.

After a while, a second, younger NKVD man came in, but I did not answer his questions either. Thereupon, he reached for his pistol and ordered me to undress immediately, else I would be shot on the spot. I had to walk back and forth in the room, stand with my face to the wall, return to the table, and finally stand against the wall again. His questions remained unanswered.

I don't know how long he continued to play this game with me. I was left alone for a while. After I had gotten

*Source: Studies 6a and 6b, undated, in Anti-Comintern File, Abt. Soviet - Union Archiv, ExP 116/87.

Appendix VI
Item 28
Page 1

95

SECRET SECURITY INFORMATION

SECRET SECURITY INFORMATION

dressed, I was taken downstairs, where an older NKVD man was waiting for me. He tried to get something out of me. When I did not reply to his questions either, he shouted at me, "Just wait, my little chick, you'll go to jail and then you'll never see the sun again!"

I was taken to a big jail and locked into a single cell on the upper floor. I remained there for almost three weeks. I was interrogated night after night. At eight o'clock in the evening, I was taken below by an NKVD man and usually not released until two or three o'clock in the morning. Time and again, I was asked about my fellow culprits and about the adults who were supposed to have engineered the whole matter. I had to get up at six o'clock in the morning, so that I could never sleep more than a few hours. I grew so weak that I could not even walk down the stairs. Several times I fainted.

At last I was taken back to NKVD headquarters. Again they tried in every conceivable way to get something out of me. I was interrogated by five NKVD men, four of whom were Jews. When I again refused to answer their questions, one of the Jews spat in my face and said that one of the other girls had already told him all he needed to know and he would release me this time. [After her release, she had to report three times a week to a female NKVD agent who each time read her a chapter of Communist literature.]

Appendix VI
Item 28
Page 2

SECRET SECURITY INFORMATION**SECRET SECURITY INFORMATION**The Case of Bruno Rungeinis

. . . During the interrogation, names were frequently mentioned which were totally strange to me and I was asked whether I knew them. When evening came, I was taken to a dimly lit room where three women waited for me. They ordered me to take off my trousers and to lie down on the couch. I did not obey. Then the women came very close, and now I saw that all three were Jewish. One of them pulled my hair; another threatened me with a pistol and ordered me to cross my hands behind my back. They tied my hands very carefully, and then the three of them pushed me onto the couch. One lifted my feet onto the couch and tied them by the ankles. Then, all three began to torture me in various ways. They twisted my nose with their fingers, pulled my ears, tried to break my finger joints, spat in my eyes, held my mouth open with their fingers and spat into it, and brutally mistreated my genital organs. They did all sorts of silly things; they stuck a penholder into my anus; two of them sat on my body and started to knead me like dough. Then they stuck me all over with needles, but never too deeply. They argued into which part of my body they should put a bullet. Frequently they stepped over to the table in order to drink something. Later they raised one end of the couch so that I was placed into a semi-upright position. One of the Jewesses held my eyes wide open, another fitted a piece of glass between my

Appendix VI
Item 28
Page 3

SECRET SECURITY INFORMATION

SECRET SECURITY INFORMATION

lids so that I could not close my eyes. The light was turned off in the room. Immediately thereafter, a blinding floodlight was directed into my eyes. Then it became dark again; this was repeated about half a dozen times. Afterwards a dim light was turned on, and I was freed of the eye openers. Meanwhile they kept on asking me whether I wanted to confess or not. If not, they would torture me to death before morning. Laughing, all three of them left the room. After a moment, one of the Jewesses returned with a young woman who wore a mask over her face. After they had exchanged a few words in Russian, the Jewess left the room. Then the young woman approached me and asked me, in a low, commiserating tone of voice, "Bruno, are you here?" -- I told her that I did not know myself. She also began questioning me about my friends, but in a very friendly, merciful way. She advised me to confess everything; otherwise things would go badly with me. She asked me whether I was suffering. I replied that my bonds were hurting my hands and that I was very thirsty. She untied my hands, held a glass of water to my lips, and told me to drink the contents. Then she left after she had told me, in a friendly manner, that all would be well if only I would admit everything. . . In the morning. . . a Russian interrogated me with the help of an interpreter. Since he got nowhere, he told me to give the names of three nationally oriented persons and to report on certain other people; I would then be freed and

Appendix VI
Item 28
Page 4

SECRET SECURITY INFORMATION**SECRET SECURITY INFORMATION**

highly rewarded. When I did not accept this proposal and did not name any other persons, I was threatened with death. Having accomplished nothing, they beat me and let me go. I had to certify over my signature that I had not been mistreated during the interrogation and that I would not under any circumstances tell anyone about my experiences. . .

The Case of Colonel Peter Dzerjve

. . . The colonel was led into a little room. "We won't hurt you," said the Armenian [an NKVD agent]. He [the colonel] would, however, have to admit all he knew about the anti-Soviet activities of two of his co-workers. The colonel coolly replied that he knew nothing about it. "Very well, we have excellent ways to make you talk," said one of the NKVD men. Upon his signal the Armenian led the colonel away. They stopped in a corridor at a booth built into the wall with barely enough room for a man to sit down in it. The NKVD man ordered the colonel to sit down, and out of the side wall of the booth he pulled a strong wooden beam which fitted like a bolt head under the colonel's chin. "Do you want to talk now?" asked the Armenian. . .

"I have nothing to say," the colonel replied. The next moment he saw his torturer getting out a strange wooden instrument holding a needle about two inches long. Then the Armenian dealt the colonel's skull one quick, forceful blow. The latter

Appendix VI
Item 28
Page 5

SECRET SECURITY INFORMATION

SECRET SECURITY INFORMATION

felt a terrible "rush" of pain; the fiend had hammered the needle deep into the top of the colonel's skull.

"I warned you," the torturer said, "act to be stubborn. I can push this needle deep enough into your brain to make you insane for life." And the monster continued to work the needle deeper into his victim's skull. The colonel, however, was silent. Only faintly he felt a new stab of pain -- the Armenian had pulled the needle out again. Then the colonel sat in the darkness of the closed booth. Gradually, he grew aware of the fact that he was experiencing more and more difficulty in breathing. He could not get any air, tried to cry out, but could not utter a word. The NKVD fiends had locked him into a torture chamber equipped in such a fashion that the air could be pumped in and out at random. When the colonel was about to pass out, his tormentors pumped the booth up again to a super-normal pressure. Four times they repeated this ghastly change from suffocation to strangulation.

The colonel did not know how many hours had passed when he staggered from the booth covered with blood and dull and indifferent to pain. . . .

Cigarette Case as Torture Instrument

[From the testimony of a Latvian who was hospitalized for a long time as a result of tortures he suffered at the hands of the NKVD.]

Appendix VI
Item 28
Page 6

100

SECRET SECURITY INFORMATION**SECRET SECURITY INFORMATION**

. . . The first interrogation lasted seventeen hours without interruption. I was accused of espionage and ordered to make a confession and to name my alleged fellow-culprits. When I rejected the unfounded accusation, I was taken to another room and interrogated again by NKVD men. A second NKVD man carrying an iron rod with a sharp point was present at the questioning. He frequently interrupted with the question: "Shall I stab him or will he confess after all?" A third NKVD man threatened to beat me with a length of rope if I did not confess. A fourth threatened me with a pistol. When I met all orders and threats with silence, all four pounced on me and beat me about the head with their fists. Beaten bloody, I was brought to the Central Prison and put in solitary confinement. The next evening I was again taken to NKVD Headquarters and was again beaten in the course of the interrogation. . . . In the course of these six days, I got nothing to eat and not a drop to drink. Only on the sixth day, when I was already completely exhausted, two herrings and half a loaf of white bread were placed into my cell in the prison. As a matter of precaution, I ate only the bread since I had to assume that after eating the salty herrings I still would not get any water for my thirst.

A day later I was to be taken to NKVD Headquarters again. I refused to go and was punished with three days of more severe confinement. I had to sleep in my underwear on the cold floor

Appendix VI
Item 28
Page 7

101

SECRET SECURITY INFORMATION

SECRET SECURITY INFORMATION

of a narrow, damp and unheated cell. My rations consisted of a little more than half a pound of bread and a pint of water. . . . Again I was taken to the NKVD and beaten unmercifully. I had to get undressed and was then wrapped in a wet sheet. I was tied to a bench and beaten with rubber truncheons. Those tortured in this manner were then locked for a day into the coldest cell in the prison. I was no exception.

[To escape his tormentors, this man pretended to accept a job as informer with the NKVD. When the pretense was discovered, he was rearrested and tortured nearly every day for two months.]

. . . . A Jew stuck a needle in my throat and stabbed my hands with a pocket knife, whereby he sneered at me and remarked that I had to lose a little blood. He also beat me over the head with the butt of a heavy pistol. In the course of another interrogation, the interrogator . . . offered me a cigarette from a metal cigarette case. When I reached for the cigarette, he suddenly shut the case, and my fingers were caught between the sharp teeth inside. The interrogator now opened the case in order to remove the skin that had been torn from the fingers. Only then I realized that the case was specially constructed for this torture. For good measure, the NKVD men rubbed my bleeding fingers with salt. When this interrogation did not bring any results, either, I was locked into a small, narrow, and hermetically sealed cell in which I could only stand up. Hot air was

Appendix VI
Item 28
Page 8

102

SECRET SECURITY INFORMATION**SECRET SECURITY INFORMATION**

now pumped into this cell. When I was close to fainting, fresh air was blown in again. This torture was continued for about 48 hours. But this was not the end of my torments. My arms were crossed and tied together, my knees pulled up, and a stick passed between my arms and knees. NKVD men held the stick by the two ends and kept on slamming me to the floor in this painful position until my kidneys had been knocked loose. . . .

[Some time later, this man was placed on a shipment to Russia, but managed to escape from the transport.]

The Torture Hat

. . . . If anyone did not immediately agree to make a confession, he was lifted with the so-called torture hat. This hat was placed around his head and fastened at the neck under the chin. A suspension device made it possible to hang the pitiable victim from a hook in the wall until he declared himself willing to confess.

The Fingernail Torture

[The NKVD seems to have employed a team of specialists for this particular form of torture.]

. . . . The Jew recounted how he had cut the flesh around the nails with a sharp knife and then slowly drawn the nail from the victim's finger with a pair of pliers. At that moment the hands of the prisoners were held by other Jewish men. The victim had screamed horribly, and most of them had confessed.

Appendix VI
Item 28
Page 9

103

SECRET SECURITY INFORMATION

SECRET SECURITY INFORMATION

"Pulling Off the Glove"

. . . [The body of] Dr. Struve was examined in Duencourg, and it was observed that the doctor's arms had been tied and the "gloves" pulled off. This means that while he was still living, his hands had been placed into boiling water and afterwards the scalded skin had been pulled off them. Nails had been driven into the soles of his feet, and his tongue had been cut out. . .

Appendix VI
Item 28
Page 10

SECRET SECURITY INFORMATION

Item 29 *

[Note: The entire article from which this is taken is an excellent dissertation on the Soviet technique of gaining confessions prior to trials. Significant excerpts from the article follow.]

. . . Dr. Anton Ciliga, a former Yugoslavian Communist arrested by the GPU in 1930 . . . said: "It is the general rule of the GPU to call arrested persons for examination during the night; a sleepy man is less concentrated, less prepared to resist. Psychology is the favourite science of the policemen of the GPU." . . . The favorite opening questions of the investigator are: "You know why you have been arrested? No, you don't know? Well, then, why do you suppose?" Later he was astonished to learn that these were precisely the questions usually put to arrested persons by the examiners of the Inquisition.

. . . As has been seen from analysing the Moscow Trials, . . . those who do appear in public must show no traces of open violence, and the process of breaking them down is a relatively lengthy one, ranging from five weeks to eight months or longer; but for those whom it is not intended the outside world shall ever see, speedier methods may be applied. And these speedier methods may be used in order to undermine the morale of the others. . . .

*Source: "The Technique of Soviet Interrogation" in Monthly Intelligence Report (United Kingdom Armed Forces publication), dtd June 1949.

Appendix VI
Item 29
Page 1

SECRET SECURITY INFORMATION

... But this "indirect" pressure is of little importance beside the very direct pressure brought to bear upon the accused who are reserved for the role of public confession of their sins. Vyshinsky himself pointed out during the Moscow Trials that there were other means of torture besides the obvious ones. He himself mentioned the effectiveness of depriving a man of sleep. Perhaps the most detailed and telling evidence regarding the "softening up" process has been given by one of the members of the Polish underground fight against Hitler. Under the pretense of reaching a political agreement with this movement, the Soviet Government induced fifteen of its leaders to go to Russia in 1945, whereupon they were immediately arrested. . . . Only one failed to "confess." [One Pole who escaped described his experiences as follows.]

... The means of mechanical "pressure" at the disposal of the investigators are, this Pole asserts, simple but extremely effective. They are -- in addition to lack of sleep -- light, hunger, cold, and an atmosphere of terror. Day and night a glaring, light burned in the prisoner's cell. If the prisoner fell asleep and turned his head from the light, the warden entered and whispered: "You are not allowed to sleep like that. I must see your eyes." There was no way for him to escape the torture of this merciless light. The cell was always kept at a low temperature, not freezingly cold, but cold enough to cause

Appendix VI
Item 29
Page 2

106

SECRET SECURITY INFORMATION

SECRET SECURITY INFORMATION

the exhausted and half-starved men the most acute physical distress. He had one blanket and was not allowed at any time to put his hand beneath it; if he did so the warden would enter and gently replace them outside the cover. . . . In the Lubianka Prison . . . absolute silence reigns, and the prisoners know that they are utterly alone. Silence, light, cold, hunger -- the food is always well prepared and appetisingly served and is just enough to keep them as hungry as ravenous beasts -- these are the elemental and terrible forces used for the "softening up" process. The psychological probing into the character, the will, the likes and dislikes, the ambitions and the weaknesses of the victim; the monotonous, relentless questioning hour after hour; the promises alternating with threats; the confrontations of the accused with fellow prisoners already broken; the displaying upon the examiners' table of personal belongings taken from those nearest and dearest to him -- all this must be realized against the background of silence, sleeplessness, hunger, cold. These proceedings lasted seventy days, during which the prisoner was interrogated 141 times for periods varying from three to fifteen hours without respite.

Appendix VI
Item 29
Page 3

107

SECRET SECURITY INFORMATION

SECRET SECURITY INFORMATION

Item 30 *

[Note: A Russian displaced person, an economic expert, was persuaded to go to the Soviet Union as a writer but was arrested upon arrival in Russia.]

. . . A few days later I was taken to be interrogated. For six days I was not permitted to sleep, was beaten . . . and insulted. You see my face. They called me an American spy and demanded that I confess. When I had breath enough to speak, I said that I had nothing to confess and asked about my wife. "She will get what's coming to her, too," said the officer.

*Source: USIA Special Weekly Rpt, No. 33, dtd 3 July 47, II, p. 7, (S)

Appendix VI
Item 30

SECRET SECURITY INFORMATION

SECRET SECURITY INFORMATION

Item 31 *

[Note: Source is a Hungarian veterinarian who fled to USSR - controlled Poland in 1940 and was arrested for illegal entry and sentenced to forced labor.]

. . . I was arrested by the NKVD. They took me to a prison. There is usually not more than one year between arrest and sentencing. In this one year, the Russian prison is so strong, so primitive, that it destroys you physically and psychologically. . . . After a few months in the prison you think about nothing human any more -- only food. There is a great release in your physical condition, for in a room of about 12x14 feet there are 44 people. . . . During this time there is frequent interrogation, especially during the night. In the prison, the political and criminal prisoners are together. . . . During the interrogation, you are charged with your paragraph and if the NKVD does not get good information from you, you are sent into solitary confinement. I was not beaten by the NKVD, but the other prisoners in my cell come back in the morning black and blue. . . . I was not beaten myself, and the other prisoners would not talk about it. In this prison, you spend no longer than a year. When the interrogation is finished, you get the sentence through the Troika; that is, the NKVD court. This Troika consists of three soldiers -- one officer and two . . .

*Source: CIA, Rpt. No. 00-I-131, dtd 27 Jan 48, sub: Interrogation and Sentencing of Prisoners. (C).

Appendix VI
Item 31
Page 1

SECRET SECURITY INFORMATION

SECRET SECURITY INFORMATION

serjants. The determination of the sentence takes only two minutes. . . . An old friend of mine, a veterinarian, was accused because many horses in his enterprise died. They called it economic agitation against the Soviet. He was interrogated for six days by many officers. He did not confess, but on the seventh day he fell asleep in the room where they were interrogating him. Then he woke up, he found that he had signed a confession. . . .

Appendix VI
Item 31
Page 2

SECRET SECURITY INFORMATION

Item 32*

A world-famous Soviet academician was arrested in Yagoda's time. He could not bring himself to confess that he was anti-Soviet. He had not yet been accused of anything else. After questioning him on his grand-parents, the investigator turned to his own life. He asked him to list all the foreign scientific societies or foreign academies of sciences of which he was an honorary member. Each time the academician named a society the investigator would jot it down and spit in the 70-year old academician's face or grey beard. . . . He walked to the next interrogation like one doomed but returned radiant and contented. He had been interrogated by another investigator, "a reliable and intelligent person." The investigator began excusing himself to the academician for the unworthiness of the preceding interrogation, declaring that the other investigator was punished and that the NKVD did not doubt the academician's loyalty. "But in order to release you, we need proof of your loyalty." Then the conversation turned to the academician's arrival abroad to attend a world-wide scientific conference in Paris. Here the investigator demanded as proof of loyalty evidence that Leon Blum himself had recruited the academician as a spy during that time, saying this was needed not as material against him but "to compromise the coalition

*Source: CI., Rpt No. 00 - B - 9037. dtd 14 Dec 48, sub: Yarkuta Concentration Camp, (C).

Appendix VI
Item 32
Page 3

SECRET SECURITY INFORMATION

government of the people's front led by Blum." The investigator's reasoning was sufficiently convincing for this academician and he signed a confession that Blum personally recruited him as a spy! . . . I have heard what happened after that.

Appendix VI
Item 32
Page 2

SECRET SECURITY INFORMATION

Item 33*

[Note: Michael Shipkov was a Bulgarian citizen employed by the United States Legation in Sofia as a translator. He was suddenly arrested on 20 Aug 1949, questioned and tortured for 32 uninterrupted hours and brought to the point where he signed a full confession of spying and sabotage and an agreement to return to the legation as a spy for the Bulgarian Security Militia.]

"I was ordered to stand facing the wall upright at a distance which allowed me to touch the wall with two fingers of my outstretched arms," he wrote. "Then to step back some twelve inches, keep my heels touching the floor, and maintain balance only with the contact of one finger on each hand. And while standing so, the interrogation continued -- nor was I allowed to collect my thoughts."

"This posture does not appear unduly painful, nor did it particularly impress me in the beginning. . . . yet, combined with the mental strain, with the continuous pressure to talk, with the utter hopelessness and the longing to get through the thing and be sent down into silence and peace -- it is a very effective manner of breaking down all resistance.

"I recall that the muscles on my legs and shoulders began to get cramped and to tremble, and that my two fingers

* Source: "How Reds Get Confessions Revealed to U.S. by Victim," New York Times, 5 Mar 50, pp. 1 and 49.

Appendix VI
Item 33
Page 1

SECRET SECURITY INFORMATION

began to bend down under the pressure, to get red all over and to ache; I remember that I was drenched with sweat and that I began to faint, although I had not exerted myself in any way. If I would try to substitute the forefinger to the big finger, I would instantly be called to order and the same if I tried to bolster my middle finger by placing the forefinger over it. No attention is paid to the suffering, nor is there any place for hope that they would take pity on you. And when the trembling increases up to the point when I collapsed, they made me sit and speak. I did get several minutes' respite, catching my breath and wiping my face, but when I had uttered again that I was innocent, it was the wall again."

So it continued. . . He would attempt to relieve the tension and satisfy the questioners, who worked in teams to allow him no rest, by confession to small things, even to spying and treason -- anything to be sent back again to his cell to await his punishment.

"Out of the jumbled memories," wrote Mr. Shipkov, "some of the impressions stand out vividly."

"One; They are not over-interested in what you tell them. It would appear that the ultimate purpose of this treatment is to break you down completely and deprive you of any will power or private thought or self-esteem, which

SECRET SECURITY INFORMATION

they achieve remarkably quickly. . . ."

"Second: I rarely could perceive any personal hatred or animosity for me -- a contempt certainly, but sooner an academic, detached feeling with an annoying problem in order to achieve the goal, and a fanatic, rabid obsession of devotion to communism and hatred for un-American resistance to them -- all the newspaper talk is to them gospel truth."

The State Department called attention to the fact that Mr. Shipkov had been forced to "build out of his own imagination details of meetings with American and other officials and other acts which the militia would interpret as espionage and treason, which in reality never took place."

The Department also pointed out that Mr. Shipkov had not been crushed to submission by the thirty-two-hour questioning alone. For months even before his arrest, . . . "he was afflicted with a feeling of oppression, fear and resignation, owing to the steady pressures exerted by the Militia on his sisters, his brothers and his colleagues in the American Legation, particularly Ivan Secoulov, who had just died."

SECRET SECURITY INFORMATION

Item 34*

[Note: Source was Czechoslovakian.]

An STB [Czech Secret Police] interrogation may include four stages:

(a) Verbal questioning, accompanied by cross-examination in the presence of four or five persons. If physical violence is employed at this stage, it does not go beyond blows of the fist;

(b) The legs of the accused are so beaten that he must be carried to his cell;

(c) The prisoner is usually bound and blindfolded and pins are driven under the fingernails; and

(d) Injections are employed to weaken the nerve centers.

* Source: CIA Information Rpt No. OO B - 9281 - 49, dtd Aug 49, (S).

SECRET SECURITY INFORMATION

Item 35*

USFA Special Biweekly Report No. 106, 9 Dec 1949, Part II, pp 6-7 (S). Subject: Interrogation Methods of the Hungarian AVO (Secret Police).

...Source was arrested. . . on 27 November 1948 in Budapest. . . Upon arrival at AVO headquarters, he was taken to the basement and locked up with twelve other prisoners. He was left there without food or water until 0800, 29 November 1948, when he was first taken to an interrogation room. . . where two interrogators received him. . . Source was told to stand facing the wall. He was compelled to remain in this position until 1600. Having had no food or water for the past two days, he was at this time on the verge of collapse. He was then seated facing the interrogators desk and the interrogation started. . . Source gave a detailed account of his work schedule. . . and told the interrogators that the charges against him were false, whereupon he was struck in the face by one of the interrogators. He collapsed completely and lost consciousness. He was revived after one of the interrogators threw a pail of water on him.

At 1900, Source was once more taken to a cell. . . . The dimensions of the cell were 1 1/2x2x2 1/2 meters. . . .

* Source: USFA Special Biweekly Rpt, No. 106, dtd 9 Dec 49, sub: Interrogation Methods of the Hungarian AVO (Secret Police), (S), Part I, pp 6-7.

SECRET SECURITY INFORMATION

It was completely dark. There were three other prisoners in the cell. . . . The floor was damp as there was no heat.

At 1900, 30 November, Source was once more taken to the interrogation room and interrogated until 1200. During this time he was not molested, but was made to remain standing before the interrogator's desk and every half hour only one question was asked by the interrogator. During the interval, the interrogator would leave the room. Upon completion of this interrogation, Source was returned to his cell.

On 31 November, Source was interrogated for the third time. This time the interrogator told him to sign a statement indicating that he was treated very well during his confinement. The interrogator was very polite and told Source that nothing would happen to him if he would sign the statement. Source signed. . . and thereafter was taken by automobile to Buda Del Internment Camp. . . [where] he remained for 72 days.

118

Appendix VI
Item 35
Page 2

SECRET SECURITY INFORMATION

SECRET SECURITY INFORMATION

Item 36*

. . . Source and his brother were arrested at 1530 on 15 July 1946 at their place of business. . . . They were questioned under strong lights by Security Police Capt. Vasile L. Veis from 1900 to 2400 and then double-timed back to their cells until 0200 [16 July] when they were again questioned until 0400.

During the questioning, Source and his brother were forced to sign six or more typewritten statements which were read to them by a secretary. Mistakes are purposely made in the typing and a complete new statement is prepared by reinterrogation and the subject is again forced to sign. This is done to find discrepancies in the statements and to break the will of the accused. The lights were so bright that they could not read the statements and so could not know what they were signing. Source was served very salty food during the interrogation, but was given no water to drink. . .

During his imprisonment, Source heard from other prisoners that three priests. . . were also imprisoned . . . and were beaten and tortured until they signed a confession that they had committed the alleged acts and were sentenced to from three to six years imprisonment. . . . Father Alachi was

* Source: USFA Special Biweekly Rpt. No. 105, dtd 25 Nov 49, sub: Mistreatment of Suspects by the Romanian Security Police, Part II, Romania, pp 6-7.

119

Appendix VI
Item 36
Page 1

SECRET SECURITY INFORMATION

SECRET SECURITY INFORMATION

confined for three days in a cell with one meter of water in it. During this time he could not sit or lie but was compelled to remain standing.

Appendix VI
Item 36
Page 2

120

SECRET SECURITY INFORMATION

SECRET SECURITY INFORMATION

Item 37*

Source was arrested by a Security Police agent at 1200, 19 May 1948, . . . and taken to the Security Police Headquarters . . . where he was put incommunicado in cell No. 5 where he remained for two days without food, water, or toilet facilities. He was told by the prison guards that if he relieved himself, he would be forced to consume it. . . .

At 0900, 11 May 1948, Source was taken to an interrogation room where he was confronted by the agent who had arrested him [and four interrogators]. . . . For the next ten or fifteen minutes [the four interrogators] slapped and kicked him from one to the other. After that, since he did not admit anything, Source was forced to squat down while his hands were tied over his knees, then a stick was inserted under his knees and arms. The two ends of the stick were lifted and supported between two tables, causing Source to hang in an upside down position. His shoes and socks were removed and the soles of his feet were beaten for about ten minutes with a stick. During this time, Lt. M --- kept asking Source if he was willing to confess. Because he was exhausted from the beating, Source stated that he was willing to confess.

* Source: USFI Special Biweekly Rpt No. 109, dtd 29 Jan 50, sub: Security Police Interrogation Methods, (S), Part II Romania, pp 5-6.

Appendix VI
Item 37

121

SECRET SECURITY INFORMATION

SECRET SECURITY INFORMATION

Item 38 *

Source was an active member of the "Actia Catholica,"
On 2 January 1949, Source, as well as many of the leading personalities of the "Actia Catholica," was arrested in simultaneous raids in Budapest and Geyer.

Source was immediately brought to the headquarters of the State Security Police in Budapest . . . and interrogated on the same night. . . . In charge of the interrogation was a police captain, while seven male and two female plain-clothes police officers were present. The first question put to Source was whether he knew why he had been arrested. [Source told a previously fabricated cover story.] . . . Source was given five minutes to change his mind. He insisted, however, that he had told the truth, whereupon the police began to mistreat him. . . .

For approximately half an hour, Source was beaten in his face with hands and fists. Since he still refused to talk, he was hit on his hands and arms with rubber truncheons for about ten minutes. Source still refused to talk, whereupon his trousers, shoes and socks were removed and he was made to lay down on his stomach and to raise his feet. Two men then stood on his right and left side and beat the soles of his feet and his shin-bones with rubber truncheons. This produced terrible

*Source: USFA Special Biweekly Rpt, No. 11, dtd 16 Sep 49, sub: Management of Hungarian Political Prisoners, Part II, pp. 15 ff.

122

Appendix VI
Item 38
Page 1

SECRET SECURITY INFORMATION

SECRET SECURITY INFORMATION

peins and Source began to cry out loudly, whereupon the men took a rope and bound his hands and feet together behind his back. In addition, his mouth was gagged so he could not cry out. The rope binding his hands and legs was laid through a pulley attached to the ceiling of the room and Source was pulled up, his arms and legs carrying the whole weight of his body. The police then began to beat him until he lost consciousness. He came to in a bath room where cold water was poured over him. He was able only to crawl but was made to return to room No. 27 and asked if he was willing to make a statement now. Source insisted that he had nothing to add to his previous statements, whereupon he was again beaten in the face. He was then forced to undress completely and all but two policemen left the room. He was made to assume a squatting position. He was given an unloaded rifle and forced to hold this in his outstretched hands. In the meantime, the two women returned and amused themselves by kicking him with their feet and beating him on the head, hands, and back with rubber truncheons. When he was unable to hold the rifle any longer, he was told that he was sabotaging the police efforts and was hit on the neck with a ruler. Source was unable to state how long he had to maintain this position. . . . When he refused to make any admissions, he had to stand on his toes facing the wall. While he maintained this position, his interrogators had their breakfast. . . . He was again beaten . . . and put into a cell two floors below ground level. I had no

Appendix VI
Item 38
Page 2

123

SECRET SECURITY INFORMATION

SECRET SECURITY INFORMATION

windows or light, the walls were wet, and it was furnished only with wooden planks. . . . Source and other prisoners were made to report their prison numbers to the policemen every five minutes through the door so that it was impossible for them to rest or relax at any time. Anyone who did not report in time was immediately beaten.

Source was left in this condition without food for about 24 hours, and the next morning was taken . . . to the interrogation room. He was first informed that anything that had happened to him up to that time was only the beginning and that the police had other measures at their disposal to make him talk. Source . . . thereupon decided to tell the truth.

Appendix VI
Item 38
Page 3

SECRET SECURITY INFORMATION

Item 39 *

Immediately upon arrival at Budaors and before any interrogation had been attempted, Rajk was subjected to the torture known as "softening the teeth." This consists in deep drilling of all the teeth after which the victim's mouth is stuffed with temporary dental filling. The prisoner is then left for a couple of hours with the sensation that his skull is bursting and that he is suffocating. In the sixty hours he spent at Budaors, Rajk four times attempted suicide.

*Source: CIA Information Rpt, No. 00-B-9315-49, Sep 19, sub: Arrest and Rajk (Hungary), (S).

appendix VI
Item 39

SECRET SECURITY INFORMATIONItem 40 *

[Note: Source was a retired Czech colonel, refugee.]

. . . Some prisoners are held in solitary confinement during the whole period of their imprisonment by the STB or OBZ, others only until they "confess." Prominent political prisoners sometimes remain in solitary confinement even after their "confession" or when already transferred to the court's custody. . . .

To obtain confession of crimes that the prisoners never knew existed and to induce the prisoner to incriminate other people, the prisoner is "de-personalized" by a combination of physical and psychological terror or drugs. The different phases of this processing complement each other. During the first months of communist rule in Czechoslovakia, the secret police agents and examiners used only the elementary methods of brutality, such as slapping and kicking. By 1949, training in MVD-sponsored courses resulted in improved methods of treatment and psychological terror.

. . . The prisoner is made to elaborate on his confession under the threat of physical torture. He is lured by promises of better treatment or release. . . . Prisoners are influenced by the sounds coming from tortured persons in neighboring cells separated by thin walls.

*Source: ID, EUCOM WDGS Inf Rpt, dtd 5 April 50, sub: Czech Interrogation Methods, (S)

Appendix VI
Item 40
Page 1

SECRET SECURITY INFORMATION**SECRET SECURITY INFORMATION**

[The following outline consists of excerpts under the heading, "Physical Terror,"]

a. Before Interrogation

Physical breakdown of important prisoners is accomplished by the following phases of torture:

(1) Prisoner's hands and legs are bound to a chair.

The chair is pushed close to an overheated radiator or other central heating device. The prisoner is blindfolded. Alone for many hours, the prisoner's nerves are in constant tension, awaiting interrogation or other torture. He is compelled to urinate in this position and is ridiculed later.

(2) After this procedure, he is beaten and kicked.

(3) Then he is sent to a solitary cell and compelled to walk constantly. After spending a whole night bound to a chair, being beaten and kicked, and then given the compulsory walking exercise, from 0600 to 2100, the prisoner is near physical exhaustion.

(4) The night before the interrogation, the prisoner is awakened by guards every half hour.

(5) Before the interrogation, the prisoner is starved completely or given an over-salted and spiced meal.

(6) Called to the interrogation, he is first placed at attention facing the wall for long hours; sometimes

127

Appendix VI
Item 40
Page 2

SECRET SECURITY INFORMATION

SECRET SECURITY INFORMATION

with hands lifted over the head.

b. During Interrogation

(1) If the prisoner cannot stand in position (6) above as long as expected, he is kicked or his head is pushed against the wall. Occasional slapping and beating is part of the interrogation. The prisoner is made to stand against a brilliantly lighted, whitewashed wall.

(2) Even when the prisoner makes his confession and signs the prefabricated "final protocol," he is not left in peace. He is called again and again to further interrogations and made to repeat the details of his confession until he knows them by heart.

(3) Later he is confronted with other co-defendants, and once more he has to repeat the incriminations stated in his confession. Thus the conviction of prisoners is made "genuine."

(4) If the prisoner denies his guilt and refuses to incriminate unknown persons, he is sent back to solitary confinement and starved. In an extremely cold or warm cell he is made to walk 15 hours daily. Then the same method of interrogation is applied, this time more brutal. In some cases teeth are kicked out of the mouth during beatings. The average prisoner can be made to succumb through repeated brutality, fatigue and fear of further torture. He realizes the hopelessness of fight when he sees that he is convicted by his friends and co-defendants

Appendix VI
Item 40
Page 3

SECRET SECURITY INFORMATION

SECRET SECURITY INFORMATION

. . . . The prisoner considers his resistance as futile and detrimental to his survival.

(5) Special methods are used for the most stubborn prisoners or for persons who realize that a signed "confession" would permit any tribunal to condemn them legally to death:

(a) The prisoner is partially undressed and is beaten on his bare feet with sand-filled cudgels, clubs, or water-soaked towels. . . .

(b) Prisoner's buttocks and the section of the body over the kidneys are beaten as above.

(c) Pins and other metallic objects are run into fingers and toes close to the nails.

(d) Women's breasts and other parts of the body are burned with cigarettes.

(e) Men's sexual organs are twisted by special pincers and beaten.

(f) Strangling of prisoner in order to force a confession is frequent.

(g) Prisoner's hands are bound to his legs behind the body and he is then lifted and fixed to a trepaze.

appendix VI
Item 40
Page 4

SECRET SECURITY INFORMATION

SECRET SECURITY INFORMATION

Item 41 *

The accused prisoner . . . is taken from his cell during the night and made to stand at attention facing a white wall for from six to ten hours. He is then interrogated by several persons whom he is not permitted to see. In the course of the interrogation, he is told what he must say before the court and how he is to act. The prisoner is neither beaten nor tortured during the interrogation. After a period of confinement, and if several interrogations have been unsuccessful, the prisoner is allegedly given two or three pills of the drug Aktedron. This narcotic makes it impossible for the prisoner to sleep, and he becomes extremely nervous and restless. Two or three days later, the prisoner is given an ice-water enema. This chills the prisoner thoroughly, causes acute diarrhea, and brings him to the verge of exhaustion. The next step is an injection of Scopolamine, resulting in an almost complete loss of memory. This injection is followed by a dosage of the drug Meskal also believed to be given by injection. This drug makes it possible for the victim to remember only what is told him while under its influence. The prisoner is now given a typewritten draft of his "confession." A reading of this manuscript results in an immediate retention of its contents. Inasmuch as his Scopolamine induced amnesia has caused him to forget everything else, the

*Source: USFA Report No. 104, 11 Nov 49, (S), Part II, p 1.

Appendix VI
Item 41
Page 1

130

SECRET SECURITY INFORMATION

SECRET SECURITY INFORMATION

accused can only repeat his "confession" in a parrot-like manner. It is therefore important that, while making his confession, the prisoner is actually under the impression that he is telling the truth.

Appendix VI
Item 41
Page 2

131

SECRET SECURITY INFORMATION

SECRET

SECURITY INFORMATION

APPENDIX VII

Item 1*

Instructions Concerning the
Interrogation of Prisoners
of War # 40

Questionnaire for the Interrogation of Prisoners of War

Headquarters _____ (Division, Corps, Regiment)

Date _____ Location on Map _____

1. Last name, first name, civilian occupation, place of birth, military occupation, rank, age, nationality, draftee or volunteer, where and when captured?
2. Unit? (Question the prisoner until you determine the highest echelon unit known to him.)
3. When and where did the unit come from? Where is it located? What is its strength? What unit did it relieve on arrival? What is its mission?
4. Location of command and observation posts?
5. Name, rank, and description of officers?
6. Adjacent units? Their location, strength, missions? Location of reserves?
7. Location and number of machine guns, mortars, antitank guns, infantry howitzers (known to the prisoner or seen by him)? Strength of reserves? Data on defensive installations (nature of antipersonnel and antitank obstacles, location of first line of defense, description of trenches, what other fortifications, minefields)?

* Source: Questionnaire, undated, in Miscellaneous G-2 File of LIV Corps, Verschiedenes, Gefangenen und Ueberlaeuferaussagen, 25.III. - 20.VI.42. The original questionnaire was found in the dispatch case of a Russian officer. The German translation is part of this file.

Appendix VII
Item 1
Page 1

132

SECRET

SECURITY INFORMATION

SECRET

SECURITY INFORMATION

8. Location and number of tanks, artillery, chemical warfare, and motorized units, new weapons (caliber and technical details)?
9. Location of air fields and terrain suitable for air landing operations? What air force units and how many aircraft at these bases?
10. Location of rear area service units?
11. What losses has the unit suffered? How is the supply, food, equipment, and clothing situation? When and where do replacements come from, and in what numbers?
12. How is the morale of the troops? What do the officers tell them? What is the attitude of officers and men toward the war? Toward one another?
13. The mood of the civilian population?
14. What are the German impressions of the performance of our armed forces (aircraft, tanks, artillery, infantry, cavalry)?
15. Credibility of the above statements? Take into consideration the prisoner's social level and background, his willingness to testify, nationality, state of exhaustion, and depression.
16. Additional questions.

The above statements were obtained from

P.O.W. _____

Signed: _____

Appendix VII
Item 1
Page 2

133

SECRET

SECURITY INFORMATION

SECRET SECURITY INFORMATION
APPENDIX VII

Item 2*

Annex 5 to: HQ XX Corps
G-2 Section No. 5820/h1
Confidential, 17 Dec 41

Questionnaire for the Interrogation of Prisoners of War

(Translation of Captured Russian Questionnaire)

1. Name of the battalion commander.
2. Equipment of the company, losses in materiel, year when the equipment was manufactured, reserves.
3. Which sector does the company defend? What are the company missions? How is the observation post organized?
4. Where is the battalion located? What are its missions? What units are adjacent?
5. What is the location of the various headquarters? What security measures have been taken for their protection? What units build the dugouts?
6. Where is battalion headquarters located? Company command post? Battalion guard?
7. What is the strength of the company? What parts of Germany or what other countries do the men come from? What is their average age? Where do the replacements come from? Details concerning the replacement system.
8. How many officers, noncommissioned officers, and men are in the company?
9. How many and what sort of acts of misconduct have occurred lately? How are they punished? Do instances of drunkenness occur?

* Source: Questionnaire, dtd 17 Dec 41, in G-2 File of 292d Infantry Division, Ic-Eingauesbergkoordinater Dienststellen, 21.VI - 27.XII.41. The German translation of the Russian original is part of this file and has been translated here.

Appendix VII
Item 2
Page 1

134

SECRET SECURITY INFORMATION

SECRET SECURITY INFORMATION

10. What orders have been issued in the last few days?

11. How is the relationship between officers, noncommissioned officers, and men?
12. Has anyone refused to obey an order?
13. Are orders carried out conscientiously and promptly?
14. Are reconnaissance patrols dispatched into [Soviet] territory behind our lines?
15. What do the German soldiers fear most?
16. How is the company quartered and where does it spend the night?
17. How are the guards detailed at night?
18. Who is allowed to pass through the guard? How are they challenged?
19. How do the German soldiers adapt themselves to cold and snow? What do they say about the weather conditions?
20. How are the officers and enlisted men dressed?
21. Do the officers mention skis? Have they received any?
22. What do the officers and men think of the partisans? Have the partisans inflicted any damage?
23. How are the relations between the soldiers and the civilian population?
24. What is being said about attacks?
25. When do the officers think they will be in Moscow?
26. Why did the German troops withdraw a few days ago?
27. Why did the Germans leave guns, tanks, ammunition, etc. behind?
28. Are any soldiers missing? If so, how do the officers interpret it?
29. How are rations and clothing? Does illness occur? Are drugs and medicine available? Are there any delousing and bathing facilities?

Appendix VII
Item 2
Page 2

135

SECRET SECURITY INFORMATION

SECRET SECURITY INFORMATION

30. To what social class does the prisoner belong? Economic position, occupation, family?
31. What benefits has he derived from the Hitler regime?
32. What allotments does his family receive?
33. What relatives of his serve in the Armed Forces?
34. Have any of his relatives or acquaintances been killed or wounded?
35. Is he a member of the Party? [Nazi Party]
36. What literature has he read? What newspapers and periodicals does he receive?
37. What is his religion? How often does he go to church?
38. What religious guidance is given to the troops?
39. What are the political activities in the company and regiment? Who is in charge of political activity?
40. How is the sexual problem being solved? What educational measures are being taken in this respect?
41. What sense do the soldiers make of this war?
42. What do the soldiers think of the conquest (occupation) of France, Greece, Norway, and other countries?
43. What reasons are advanced for Germany's war against the Soviet Union?
44. What does this war have to offer the soldiers -- now and in the future?

A True Copy Corps HQ, 17 Dec 41

(Signature illegible)
1st Lieutenant

Appendix VII
Item 2
Page 3

SECRET SECURITY INFORMATION**SECRET SECURITY INFORMATION**
APPENDIX VIII

Documentary Excerpts:
Soviet Methods of Interrogating
Japanese Prisoners of War

The information for the reports was based in interrogation of selected Japanese who were being repatriated during the latter part of 1949 from the Soviet Union after having been held in Soviet prisoner-of-war camps for about four years. Some discrepancies appear in the reports, but these reflect the fact that methods employed by Russian interrogators were different in various areas; violence was used often by interrogators in Manchuria but only occasionally in Siberia.

Item 1

This report presents the views of two well qualified repatriates.

1. This report is based on research conducted at the Meizuru Repatriation Center in regards to the Soviet methods of interrogation. . . .

a. It is true that a large number of repatriates were investigated by the Russian authorities regarding their personal and military history. However, with the exception of the personnel in the category mentioned in paragraph "c" below, who have not been repatriated, these investigations for the most part appeared routine and general in nature. . . .

b. The overall strength of the Japanese units was not investigated by the Soviet authorities. All PWs were required to complete history forms which were collected and carefully screened by trained Russian Army personnel. These forms enabled the Soviet authorities to select and later segregate certain PWs for thorough investigation. Where this form proved inadequate in providing pertinent information, extensive use of PW informants was made to fill the gap.

c. Former field grade officers and above, Military Police, Special Service, Intelligence, Signal, Border Guard, specialists in such fields as aviation, electronics, bacteriology, chemical warfare, graduates of language schools specializing in Russian, and those suspected of being in any of these categories were investigated by the Russian authorities. . . .

*Reference: T/I, G-2, CHQ, Report No. TB-2384 #4578, dtd 1 Oct 49 and Report No. TB-47-50 dtd 18 Jan 50, Sub: Historical Study on Russian Methods of Interrogating Captured Personnel, (S). Item 1 is from Report No. TB 2384 #4578; items 2-19 from Report No. TB-47-50.

SECRET SECURITY INFORMATION

Appendix VIII
Page 1

SECRET SECURITY INFORMATION

d. Reports indicate that a considerable number of PWs in the above categories (par. "c" above) have been tried and convicted in Military Courts and sentenced to 5 to 25 years. . . .

2. The Soviet method of interrogation and pertinent experiences of numerous prisoners of war are outlined as follows:

- (1) A personal history form is filled out by each prisoner of war. This form is collected and carefully screened by Russian military officials to decide whether or not the PW is to be investigated.
- (2) There are two ways in which a PW is summoned for investigation; formally, through the office of the Japanese PW Camp Headquarters, and secretly.
- (3) The time, length, and frequency of investigation are not consistent. In many cases, investigations are conducted in the early hours of the morning, and as often as is deemed necessary by the investigator. On the average an interrogation lasts about one (1) hour to two (2) hours depending upon the situation.
- (4) Routine investigations are usually conducted in small rooms with overhead lights. In some instances strong lights were flashed in the prisoner's face. It is customary to lay a pistol on the table with the muzzle pointing towards the person being investigated.
- (5) Investigators conduct interrogations very calmly and without losing their tempers. In only one instance was physical violence reported. Generally, no coercive measures were taken to force prisoners to talk. However, some of the suspects were reportedly thrown into solitary confinement.
- (6) Investigators proceed with the interrogation very slowly without pressing the issue. They take as much time as necessary and repeat the same questions until satisfactory answer is given. Whenever a statement is in discord with the previous statement, great importance is attached to the variance and often times the investigation deviates from its primary objectives.

Appendix VIII
Page 2

138

SECRET SECURITY INFORMATION

SECRET SECURITY INFORMATION

- (7) All PWs under investigation are made to swear that . . . statements made by them are true by signing their name at the bottom of the report. In some instances, the reports are deliberately distorted and falsified by the investigators who take advantage of the PWs who do not understand Russian language.
- (8) Type of questions depend on the prisoner's background, and, for the most part, answers given to routine questionnaires on the prisoner's military history are clarified.
- (9) Extensive use of PW informants is made by the Russians, who use threats, coercion, and promises of better treatment to exact information.
- (10)
- (11)
- (12) It appears that the great majority of the investigating officers are usually second Junior lieutenants or senior lieutenants -- probably due to low priority investigation. In no instances were enlisted men used. Some of the investigating officers spoke Japanese; however, most of them required an interpreter, usually another Russian officer, or in extreme cases PW interpreter. In one instance, a female interpreter, a graduate of the language school in Leningrad sic, interpreted for a senior lieutenant.
- (13) Officers from various sections appeared to conduct the investigations. Although the repatriate's statements were ambiguous, it is believed that investigations were conducted largely by MVD officers. . . .

Item 2

A Japanese repatriate, who had been compelled to work as an interpreter for the Soviet Investigation Section (Ochyo) in a prisoner-of-war camp at Nakodka, made a voluntary report for American officials in the form of a dialogue which he purports to be typical of the Soviet interrogations at which he was present. It will be noted that this interrogation of a Japanese prisoner contains a number of elements common to what has been learned about interrogations of German prisoners -- emphasis on political matters, threats of non-repatriation, cross-examination on minor points in an attempt to find discrepancies, frequent accusations that the prisoner is lying, attempts to discover names of prisoners formerly connected with military intelligence. The report, therefore, is reproduced here in its entirety.

SECRET SECURITY INFORMATION

Appendix VIII
Page 3

139

SECRET SECURITY INFORMATION

"A" - Soldier of the 11th Air Intelligence Regiment (Air Group)
 "B" - Soviet Interrogator

Q - (Name, age, registered domicile, occupation, and personal history are asked according to form.)

It is four years since the war ended. At this date our purpose of interrogating you is not to investigate and punish you, or anything of that nature. You merely carried out the orders of your superiors. Our purpose, at this time when America is trying to start a Third World War, is to appeal to the peoples of the world the brutality of war, to create opposition to war, and to examine thoroughly the intelligence organization of the Japanese Fascist Army for future reference. You probably know that the Japanese monopoly "Zaibatsu" and "Militarists" are organizing an army of police for the next war. If you are a democrat and a lover of peace, tell us all you know for the sake of strengthening the democratic front.

A - Yes. I will tell you all I know.

Q - Very well. Then do you know that if you withhold information or make false statements you will be punished with a maximum of three years imprisonment under the Soviet Code, Article 95. (Sometimes the interrogators say maximum of five years, and other times two years.)

A - I understand.

Q - Very well. Then sign your name here. (Prisoner of war signs paper bearing Article 95.) What were your duties as an Air Force intelligence soldier?

A - I was an ordinary soldier.

Q - I know that. What kind of work did you do?

A - In the company, drill and fatigue duty; and every two or four months relieved the observation party at the border.

Q - What did you do there?

A - Observed Soviet aircraft from an observation tower ^{with aid of} glasses. (As though the formations of regimental, company, and platoon observations parties are not very important, the investigation on this matter is extremely brief and nothing is written on the investigation sheet.) The number and type of aircraft and their direction of flight was reported to personnel below, which information was then put into code and sent to the platoon. (The name and duties of officers, N.C.O.'s and other E.M.'s once connected with observation posts and now interned in the Soviet Union are sought.)

SECRET SECURITY INFORMATIONAppendix VIII
Page 4

140

SECRET SECURITY INFORMATION

Q - What else?

A - Each day we reported the weather conditions.

Q - What else?

A - . . . ? That is all.

Q - There must be more. You observed the airfield too, didn't you?

A - Oh, the airfield! The airfield was on the other side of the mountain, so we could not see it.

Q - That is understood. But you knew from the take off and landing of aircraft that there was an airfield, didn't you?

A - Yes, we did.

Q - And of course you reported that?

A - No, the existence of an airfield there was known from before, so there was no need to report it. (Here the prisoner of war is questioned on whether that information was reported, but finally conceding that the prisoner of war is telling the truth, the interrogator proceeds.)

Q - Very well, then, what else did you observe?

A - That is all.

Q - You didn't see anything?

A - No, I didn't.

Q - You said that you were a democrat, but that is a lie. You are a fascist. When you return to Japan you will become a soldier again, and as a tool of America fight against the Soviet, won't you?

A - No, I am a democrat. I will never fight again.

Q - Then tell the truth. What else did you see?

A - What else? . . . but I have not seen anything else.

Q - Are you trying to make a fool of me? (Here the prisoner of war is sworn at, or the table pounded.) You are lying, you have seen more. Tell me!

A - More? . . . ???

SECRET SECURITY INFORMATION

141

Appendix VIII
Page 5

SECRET SECURITY INFORMATION

Q - (Showing anger). Didn't you see mountains? Didn't you see any villages? Didn't you see any rivers? Can't your eyes see anything but the sky?

A - Oh, mountains! Yes, I saw mountains.

Q - There you are! Trying to tell me you saw nothing. And what was there on the mountains?

A - On the mountains? . . . trees . . . rocks? (Here there are some prisoners of war who claim having observed Soviet positions and pillboxes. Some were not as observing. Interrogation of those who said they saw the positions proceeded along, but those who were not as observing were barraged with the same question until they became convinced that they, too, had observed them.)

Q - How many pillboxes did you see?

A - I saw three directly in front of me.

Q - (The prisoner of war is questioned in great detail on the entering and leaving of Soviet soldiers, movement of units, the relief hours of sentries on Soviet observation towers, the condition of villages, movement of boats in the river, and their cargoes.) Did you report them?

A - No, I didn't report them. Those reports were the responsibility of the infantry observation parties, and not ours.

Q - Wait a minute. There you go talking nonsense again. The infantry made its reports, and you must have made your own.

A - No. Ours was an airforce intelligence unit, so it reported only on matters concerning the airforce. Our chief duty was observing Soviet aircraft that flew across the border.

Q - I know that without having you tell me. The army was not feeding and keeping you for the purpose of having you gaze at red-skirted Soviet girls playing in the villages. Besides there was no aircraft in the air every day. It is impossible that you did not report the enemy's pillboxes and the entering and leaving of Soviet soldiers. (The prisoners of war are repeatedly questioned about this, but everyone replied they had not made such reports. Of 20 airforce intelligence soldiers for whom I interpreted, there was only one who said that he made such a report. There were several who were at this point, intimidated, verbally abused, upbraided, and in the end, thrown into the guard house where they were left for twenty-four hours. As for the others. . . .) You are not the only one I am investigating. I have already investigated several hundred. They have all spoken the truth, made clear breast of the filth of that dark, fascist era, and gone home to Japan. You did make the report, didn't you? Tell the truth and you will be going home on the next boat. If you do not, you will be tried in court under Article 95 and questioned formally.

SECRET SECURITY INFORMATION

SECRET SECURITY INFORMATION

A - But I ----????

Q - You talked to your NCO about what you saw, didn't you?

A - Yes, I talked to the NCO about it, but . . .

Q - Then the NCO made the report back to the platoon, didn't he?

A - I do not know. Since the relief hours of the Soviet sentries were fixed and it was nothing unusual, there was no reason for him to make a report.

Q - That may be so. However, a moment ago you mentioned having observed about ten soldiers going in some direction. That must have been reported back to the platoon by your NCO.

A - Is that so?

Q - Now you acknowledge that your unit was an informational and intelligence unit, don't you? (Here the prisoner of war is forced into acknowledging such, and the interrogation is brought to a close.)

The prisoner of war wrote out in Japanese:

Date: type, number, and direction of flight of aircraft.

Date: (Same as above.)

Date: Observed border patrol of five soldiers moving from east to west.

Date: A number of boats loaded with what appeared to be military supplies moved up Ussuri River.

Date: Unit about strength of one platoon living in tents.

There were forced to attach their signatures to the above. automobile drivers with the Air Force Intelligence Unit, who performed no duties on observation towers, were asked if there was anyone to prove their innocence of such activities. Such soldiers gave the names of everyone they knew who was interned in the Soviet, particularly those at NAKHCHUKA Zsic. They were then compelled to write and sign the statement that they performed their duties as soldiers of the Informational and Intelligence Unit of the Japanese Army. "Intelligence" seemed to be the focal point of the Soviet investigations, and prisoners of war were absolutely forced to acknowledge the fact that they were engaged in that function. Some interpreters translated the Russian word for "Intelligence" as "Spy" (Chocho) causing prisoners of war to refuse to attach their signatures, and thereby delaying interrogation proceedings. A meeting was held at which Soviet interpreters were also present, and it was agreed to interpret the word as "Reconnaissance" (Teisatsu). . . .

SECRET SECURITY INFORMATION

SECRET SECURITY INFORMATION

Item 3

[Source: Japanese Sergeant Major]

During investigation, subject was clubbed over the head with a pistol butt and then placed in solitary confinement without any blankets when the weather was about 30 degrees below zero. Subject had to jump up and down throughout the night to keep warm.

In general, the prisoners of war are forced to work during the day and interrogated during the night.

Some investigators try to get suspects to admit to false accusations by saying that his friends have already revealed evidences against them.

When suspects are released again to the prisoner of war camps, they are made to swear that they will not reveal the purpose and contents of the investigation. In subject's prisoner of war camp, prisoner of war informants deliberately gave names of those not connected with the "Zenshoku" (former members of the Intelligence, Military Police, Tokumukikan [Japanese counterintelligence and espionage] Police, etc.), for the sole purpose of winning favoritism from the Russian prisoner of war camp officials.

Item 4

[Source: Japanese Corporal]

Subject was interrogated three (3) times. The investigator tried to connect subject with being a "Tokumukikan."

When a suspect is under investigation he is usually segregated from his friends who are to undergo subsequent questioning.

Russian authorities require the evidence of at least three (3) witnesses to affirm whether or not a suspect is guilty.

Item 5

[Source: Japanese Sergeant]

Subject was interrogated twice in the MITSUI [sic] Building in MUKDEN, MANCHURIA [sic] on the pretense of being a former military policeman and of having organized an underground unit to resist the Soviet occupation of Manchuria. When subject denied knowledge of hidden weapons he was struck on the head with a broken chair leg and then kneed in the stomach, disabling him temporarily. He was told that if he still persisted in taking an "I don't know attitude," he would be whipped until he changed it.

SECRET SECURITY INFORMATION

144

Appendix VIII
Page 8

SECRET SECURITY INFORMATION

On both occasions the interpreters were local White Russian prostitutes, probably recruited for this job on a temporary basis. These female interpreters were very incompetent and their knowledge of the Japanese language was very limited. It was believed that the Russians were ill prepared to handle interrogations of this kind due to shortage of Japanese speaking Russian linguists.

Seldom was the investigation report translated into Japanese so the subject could read it over for any misinterpretations. (Before signing his name to it.)

Item 6

[Source: Japanese civilian]

Subject was interrogated three (3) times in MUKDEN, MANCHURIA [sic] prior to being sent to Siberia. He was last interrogated at KARAGANDA [sic].

As commonly practiced by Soviet investigators, when they first entered Manchuria, the first two (2) interrogations involved physical violence. Subject was struck with a stick and knocked to the floor. Again, during the second investigation subject was struck on the head with an iron stoker, causing a deep gash on his head.

The latter violence occurred when the investigator, another officer and a sergeant decided to take time out during the investigation for a drink. Subject claimed that the investigators were intoxicated when this incident occurred. He was given first aid treatment after they realized what they had done.

Subject claimed that the report made by this officer was deliberately distorted because he was later accused during subsequent investigation of having made incriminating statements which involved him in crime against the Soviet Union. Subject claimed that he was not allowed to read the completed report to verify the contents.

During the investigation, the investigator produced several reports, furnished by prisoner of war informants, which he claimed were evidences contradicting his statements. Subject refused to believe these and stubbornly stuck to his story.

Subject was imprisoned in a solitary cell when he denied the investigator's accusations. Food was increased or decreased depending on how cooperative subject was.

Subject was later asked to inform on other prisoner of war suspects.

SECRET SECURITY INFORMATION

145

Appendix VIII
Page 9

SECRET SECURITY INFORMATION

Item 7

[Source: Japanese 2d Lieutenant]

In general, prisoners of war who were formerly assigned to units in China were questioned in NAKHODKA [sic]. It was believed that those who participated in action against the Communist forces were detained and sent to the interior. (Note: Excluding war criminals).

MINSHU [sic] Group [so-called Democratic Movement in camps, corresponded to "Antifu" in German camps/ activists were utilized to a large extent as informants for the investigating officer. Rumor was prevalent in CHEREMKHOVO [sic] #32/8 Prisoner of War Camp that some of the informants received monetary compensation for revealing names of suspects. A large number of prisoners of war were intimidated into revealing names of suspects.

The investigating officers were usually MVD officers assigned to each prisoner of war camp. Occasionally MVD officers were dispatched from the District MVD Headquarters for the sole purpose of conducting interrogations. The average rank of investigating officers was lieutenant.

Majority of the investigating officers are believed to have had little experience in investigation work. They all seemed to go into a tangent and over emphasize the insignificant rather than important things. None of these investigating officers spoke Japanese. The interrogations were conducted with incompetent interpreters who often times misinterpreted the suspects' statements.

None of the suspects who underwent interrogation were reminded of their rights as prisoners of war.

Investigation became stringent simultaneously with the activation of the MINSHU Group. Prior to this, prisoners of war regardless of their rank, past assignments, ideals, etc., were repatriated without undergoing investigation.

Item 8

[Source: Japanese Superior Private]

Members of the military police, Tokumukikan, Intelligence personnel and spies, who are responsible for aiding in the prosecution of war against the Soviets, and those that have arrested communists, have been or are in the process of being sent to KHABAROVSK [sic] for trial in military court. The rest have been assembled and placed in special PW Camps, under heavy guard.

146

Appendix VIII
Page 10

SECRET SECURITY INFORMATION

SECRET SECURITY INFORMATION

In KHURMULI [sic], there was a District OCHYO [sic] (Investigation Section) staffed with a lieutenant colonel and 15 company grade officers to assist him. At vital areas, sub-offices have been established to house the investigators from the above district OCHYO [sic], who are then dispatched to various prisoner of war camps to conduct interrogations. None of the investigators are stationed in the prisoner of war camps. Instead, liaison is maintained with the personnel office within each prisoner of war camp, Russian prisoner-of-war camp doctors, and informants who have been instructed to report any suspicious prisoners who may be potential war criminals.

One investigator employed the following method in getting evidence on a suspect. First the suspect was thrown in solitary confinement for a short period without any food and then released. An informant was secretly planted in the prisoner of war camp to observe the suspect's actions. At the right time the informant approached the suspect, striking up a conversation and pretending to sympathize with him when he heard that he was investigated. Around lunch time the informant invited suspect out to lunch, to which the suspect readily agreed since he was always hungry. After a few days of this the informant was able to convince him that he was his true friend, since he too was also suspected by the Russian authorities, and that the two (2) should stick together. In a short time the informant was able to get the information that was required.

Item 9

[Source: Japanese civilian]

Subject was interrogated at KHABAROVSK [sic].

With the aid of informants the Russian investigators first seek out the suspect's former assignment.

The purpose for calling a suspect in for questioning is well concealed. To the rest of the prisoners of war it is made to appear as though the suspect is called in for a reprimand regarding his work. With the definite purpose of trying to connect suspect with being a potential war criminal the investigation usually starts with some critical remarks regarding suspect's work in the field thus throwing him momentarily off guard.

When a suspect is called in for interrogation he is usually asked if he has family in Japan or if he wishes to be repatriated. He is told that if he refuses to tell the truth he will not be repatriated and that he will be secretly shot.

When the investigation makes no headway, the investigator frequently loses his temper and flashes a pistol at the suspect, thus hoping to draw out information.

147

Appendix VIII
Page 11

SECRET SECURITY INFORMATION

SECRET SECURITY INFORMATION

After several attempts, if the suspect still refuses to talk or reveal the desired information he is thrown in solitary cell sans shoes or outer garments leaving him with only shorts to combat the bitter below zero weather. When the cold becomes unbearable the suspect will jump up and down until the guard comes around to stop him.

Subjects are freely thrown in solitary confinement purely to torture their mind into revealing the information. Confinement can be from one week to a month or even longer. While in confinement suspects are given one hundred fifty (150) grams of black bread and salty soup daily. Within a few days suspects become so hunger-ridden that they admit to anything, regardless of the consequences.

When the investigator is unable to get any information on a particular suspect in one camp he may be transferred to another camp until an informant recognizes him.

If the findings during the interrogation proves important, higher ranking officers (field grade) are called to make further detailed interrogation. Normally company grade officers carry out majority of the investigations.

Informants, depending on the successfulness of their work, received fifty (50) rubles while others received preferential treatment, such as menial work within the prisoner of war camp or work in the kitchen where plenty of good food is assured.

If the informant becomes known to other prisoners of war, that informant is usually transferred to another prisoner of war camp where he continues with the work unhampered.

Spies are sometimes sent into the cell pretending to comfort the suspect thereby winning his confidence and perhaps later revealing matters sought by the investigator.

Considerable number of "ZENSHOKU" /sic/ (Military Police, Intelligence, etc.) personnel are used as informants and are promised with early repatriation, good treatment, etc. These informants are well qualified . . . /for/ the work due to their extensive training in spy work with the Japanese Army.

Some of the former Japanese "Tokumukikan," White Russian and Japanese spies, trained at the HARBIN /sic/ Institute have become interpreters for the Russian investigators. These interpreters due to their background took a leading role in the investigation work itself. . . .

The interrogation conducted at subject's prisoner of war camp was based mostly on the following: Whereabouts of the Russian spies sent into Manchuria. Japanese contacts in Siberia. This is for the purpose of prosecuting the traitorous Russian agents of the Japanese.

SECRET SECURITY INFORMATION**SECRET SECURITY INFORMATION**

The Russians are known to lie. During interrogation it is best not to heed their promises. Better to face the fact, than trying to escape from it; the result would be the same anyway.

If one is under suspicion it is a good policy to fake illness and be transferred to a hospital. The Russians very seldom interrogated patients. The patients, upon recovering are usually sent to other prisoners of war camps. Thus your chance of escaping an investigation is improved.

Item 10

[Source: Japanese 1st Lieutenant]

Subject acted as interpreter during one (1) investigation.

This interrogation was conducted during the winter months when the weather was extremely cold. The suspect who refused to cooperate with the investigator was placed in an unheated cell. The suspect was put on starvation diet for a period of time and during interrogation rich food was placed in front of him to induce him to talk.

Item 11

[Source: Japanese civilian]

Subject was investigated twice at the KRASNOYARSK /sic/ #34/5 Prisoner of War Camp. After being cleared, this subject acted as an interpreter for two subsequent investigations conducted at the MVD Headquarters in KRASNOYARSK /sic/.

During the first stage of investigation, Japanese Prisoners of War were used extensively as interpreters or they investigated for the investigating officer. This was due to lack of Japanese speaking Russian personnel. Later White Russians from Manchuria were recruited and made to interpret at the investigations. These interpreters were highly inexperienced and unqualified in this field of work. Consequently mistakes were made in the reports and innocent suspects were adjudged guilty of "crimes" they never committed. Many of the prisoners of war are still suffering from this fate without any hopes of rectifying the situation.

The investigators that this subject had personal contact with were believed to be mediocre as investigators; they appear to lack finesse in their interrogation methods. They were unable to gather intelligence systematically and they seem to deviate frequently from their primary objective. For instance, one (1) investigator was trying to find out how much information was gotten across the border into Manchuria, but he ended up by concentrating on the duties and missions of the "Tokumukik."

SECRET SECURITY INFORMATION

SECRET SECURITY INFORMATION

Item 12

[Source: Japanese soldier, rank unknown]

Subject was informed on by a friend who was in the same unit. The investigator probed for information regarding the Japanese Police System. Subject was interrogated by an MVD officer who was dispatched from the MVD Office, in SPAASK [sic] and in ARTEM [sic] by the MVD Officer detailed to the prisoner of war camp.

From personal observation, subject is inclined to think that Russian investigators are rather incompetent in their field. They seem to try to seek information on something they know nothing about without first making a research. For instance, the organization of the Japanese Police System. Normally if an investigator is interested in the above, he would first make some attempt to know something about the subject before commencing with the interrogation. Often times the investigator would be too gullible and made a fool of only because he was completely ignorant of the subject he was delving into.

The Russian investigators usually follow the "You are guilty unless you can prove otherwise" method of interrogation. They try to force the suspect to admit what they think is right. Until a satisfactory answer is given, the investigator will persistently repeat the same question over and over again. The Russian method of interrogation appears to follow one pattern. Thus, suspects with reasonable amount of intelligence can perceive beforehand what question will be asked next.

The investigators very seldom resort to physical violence, but instead they put suspects in solitary cells with little or no food over a period of days, thus torturing them mentally. This to the Russians is believed the most effective method in drawing out information.

Item 13

[Source: Japanese 2d Lieutenant]

Subject heard that the most effective torture method to which suspects were subjected at this camp was putting them in a small cell and forcing them to stand up throughout the night, with only three hundred (300) grams of black bread and water for diet. Interrogations were then deliberately conducted late in the night when suspects were too sleepy or tired to withstand the ordeal. Many of them passed out during the interrogation.

Spies, ostensibly to comfort the suspects in solitary cells, were infrequently sent in to collect information for the investigation

Appendix VIII
Page 14

150

SECRET SECURITY INFORMATION

SECRET SECURITY INFORMATION

Subject believes the most effective means of extracting information from a stubborn suspect is to starve him or otherwise subject him to harsh treatment and then promise him that he would be repatriated early if he reveals all he knows.

Item 14

[Source: Japanese 2d Lieutenant]

Subject was interrogated at TSITSIHAR [sic], Manchuria where he was suspected of being a member of a guerrilla unit which was to harass the Soviet Occupation troops. Subject was questioned at all hours of the day and night for ten (10) straight days. Some of the interrogations were twelve to fourteen (12 to 14) hours in duration.

Subject was hit with fists, given the water treatment, shocked with live wires, had pieces of wood twice as thick as pencils put between his fingers and squeezed. This subject was shot in the leg with a pistol. The latter occurred when subject became so enraged at the investigator's tactics that he demanded to be shot if they doubted him so much. Subject was given soy sauce to dress his wound with. The investigator was an MVD senior lieutenant, whose name the subject unfortunately did not know.

Subject does not know whether or not the Russian investigator falsified his answers because he wrote his statements in Japanese and this was translated. He was ordered to sign the translated report but since the interpreter refused to divulge the contents he refused to sign it and was beaten again.

The majority of the prisoners of war who were interrogated in Manchuria were reported to have been abused by the investigating officers. Many of them bear marks of violence on their bodies. Contrary to the above, subject stated that investigations in the USSR were conducted rather "humanely" except for the solitary cell treatment.

Subject stated that of the various treatments he received at the hands of Soviet investigators, the solitary cell treatments he received were the most effective method. After a few days in an unheated, dark cell, without food and bedding, a suspect will admit anything. . . .

Item 15

[Source: Japanese Corporal]

Extensive use of prisoner of war informants, usually MINSHU [sic] Group "aktiv" was made by the Russians to collect information on suspected prisoners of war. Some of the prisoners of war were believed to have collected information voluntarily and informed the Russian officials purely for selfish reasons. Thus it came to a point where one could not trust even his best friends.

151

Appendix VIII
Page 15

SECRET SECURITY INFORMATION

SECRET SECURITY INFORMATION

Item 16

[Source: Japanese 2d Class Private]

Subject was suspected of being a "Tokumukikan" purely because he spoke fluent Russian. He was interrogated twice at the ANGREN [sic] #372/2 Prisoner of War Camp.

While the interrogation was in progress a Captain (name unknown) barged in and relieved the investigator (2d Lt "ARUHIPOVICH" [sic]) because he thought the interrogation was being conducted too leniently. This Captain was very arrogant and he gloated in seeing the subject suffer.

Subject was thrown in a solitary cell for eighty (80) days when he denied the Captain's accusation. Subject stated that the suffering he went through in this cell cannot be described with words.

The standard diet for the inmates of this cell was four hundred (400) grams of black bread, forty five (45) grams of cereal, five hundred (500) grams of vegetables and seven (7) grams of sugar daily. However, the full ration was never received because the guards had a tendency to pilfer the food while it was being delivered.

Item 17

[Source: Japanese Superior Private]

The Russian investigators have a tendency at the slightest provocation to throw suspects in solitary confinement with meagre bread ration and tea. The degree of provocation, however, is never standard but depends on the mood of the investigator.

Many suspects are made to admit or reveal information by simply promising them good treatment and early repatriation after subjecting them to harsh treatment. This is believed the most effective and popular method of drawing out information from stubborn suspects.

Item 18

[Source: Japanese 2d Lieutenant]

In general, the interrogations are conducted during the night, after the prisoners of war returned from a hard day of work. These interrogations sometimes continue throughout the night and the morning without sleep or rest. This type of interrogation is usually continued over a period of time until the interrogee breaks down or until such time as the investigator feels satisfied with the testimony.

Since abusing the prisoners of war during interrogation is a violation of the Soviet Criminal Code, most of the investigators are believed to be abiding by the regulation. (NOTE: Placing suspects in solitary cells with

152

Appendix VIII
Page 16

SECRET SECURITY INFORMATION

SECRET SECURITY INFORMATION

little or no food is apparently permitted.) However, there are occasions where investigators disregard the Code and resort to violence. For instance, subject heard from a YOSHIDA [sic], (PW) former "Tokumukikan," that during interrogation the investigator crushed a live cigarette against his nose, whipped him with a leather belt and placed him in a solitary cell on starvation diet.

A number of probationary interpreters (Russians) are sent to various prisoner of war camps to become familiar with the Japanese language and customs. Among them are young girls (average 20 years of age) who practice at investigations conducted on prisoner of war suspects. Due to this fact, many errors are made in the investigation report thus causing undue hardship on the prisoner of war suspects. Subject observed four (4) young female interpreters from MOSCOW [sic] who came to the RAICHIKHINSK [sic] #19/1 Branch Prisoner of War Camp to study the language. These girls were given free reign of the prisoner of war camp, mixing with the prisoners as much as possible.

Item 19

[Source: Japanese Corporal]

Subject was imprisoned for two (2) months at the MVD Headquarters in KHURMULI [sic] during which time he underwent successive interrogations regarding his past activities as a policeman. Later he was suspected of being a former "Tokumukikan."

The regular food allotted prisoner-of-war inmates in the solitary cell was fixed at three hundred fifty (350) grams of bread and water daily. Subject however received only about one hundred (100) grams daily. Infrequently small amounts of meat and vegetables were brought in to augment the starvation diet. On several occasions subject was denied food altogether. During the second month of imprisonment, the subject became so emaciated from hunger that he had to use a walking stick even to go to and from the latrine.

The interpreter for the investigation was a White Russian, presumably recruited from the White Russian settlement in HARBIN [sic], Manchuria. The White Russian's linguistic ability was very limited, and as a result, the subject was often misquoted during the interrogation.

The interpreter's monthly salary was only eight hundred (800) rubles after various deductions. This was far too inadequate for him to make a fair living. He was often observed pilfering food which was provided for the prisoners of war imprisoned at this headquarters.

The interrogation of "Zenshoku" personnel (Former Military Police, Tokumukikan, Police, Intelligence personnel, etc.) became active simultaneously with the formation of the MINSHU [sic] Group. Until then it was

153.

Appendix VIII
Page 17

SECRET SECURITY INFORMATION

SECRET SECURITY INFORMATION

extremely difficult for the Russians to detect these personnel because they had faked their former assignment. . . . Together with the aid of prisoner of war interpreters the Russians thus began whole-sale investigation of the "Zenshoku" personnel.

The purpose behind the mass interrogation is much deeper than one thinks. It is apparent that the Russians are desperately looking for evidences and material for the coming Japanese Peace Treaty Conference which would enable her to have more than a "grandstand seat."

SECRET SECURITY INFORMATION

SECRET SECURITY INFORMATION
APPENDIX IX

Documentary Excerpt:
North Korean Interrogation Methods

Note: This analysis was based on information obtained from fourteen prisoner-of-war interrogation reports, the translation of an enemy document, and the special interrogation of three liberated American prisoners of war. While this information, strictly speaking, falls outside the scope of this study, it has been included in this appendix because it is pertinent, timely, and significant.

a. General. Initially, responsibility for PW questioning along military lines apparently was vested in NK reconnaissance units at the various echelons beginning with the regiment. These interrogations were brief and were limited to the obtaining of combat intelligence of immediate value to the unit concerned. Upon completion of this phase captives were turned over to the NK security police of the Ministry of the Interior, who continued interrogating along strategic and political lines. Later reports indicate, however, that unit interrogations may now be conducted, at least in part, by newly-formed divisional psychological warfare sections. . . . Detailed information concerning NK interrogation procedures (as applied to US PWs) has been obtained from three liberated US PWs, an officer and two NCOs, all of whom were captured in September 1950 and spent nearly a month in captivity. Their statements reveal the following items of particular significance:

- 1) Interrogations are characterized by almost complete channelization along political lines in an apparent attempt to reveal generally the political stability of the average American soldier and, in particular, to determine the possibility of converting the interrogee to communist tenets. The eliciting of military information appears to be of secondary importance.
- 2) Soviet officers accompanied combat units south of the 38th Parallel and conducted interrogations of selected US officer personnel.

* Reference: T/I, G-2, GHQ, FEC, Report No. TB-1161-50, 30 Oct 50, Sub: North Korean PW Interrogation Methods (S).

SECRET SECURITY INFORMATION

SECRET SECURITY INFORMATION

3) Accurate dossiers on officers of at least one US division, the 24th, are available to NK interrogators and were apparently compiled from information contained in official correspondence to which native NK intelligence agents could not have had access.

b. Selection for Interrogation: A captured enemy document offers some insight into initial processing of UN PWs and their selection for interrogation by NKA personnel. According to this document, a staff field manual, PWs are segregated according to rank and the units to which they were assigned. Officers and enlisted men are handled separately. Interrogations at regimental level are simple and calculated to obtain only that data which bears on the unit's immediate operations. Interrogation data thus obtained is recorded on special forms and, together with any captured documents, accompanies the PW to division headquarters. The division reconnaissance chief, after a preliminary inspection of the interrogation forms, selects likely informants and supervises their interrogation along lines determined by the intelligence requirements of various staff sections. The interrogations are submitted immediately to corps headquarters regardless of whether the interrogees are to be detained or turned over to NK police authorities. Although these regulations are definite, indications are that they are not universally observed. In actual practice, interrogation at regimental level seems to be limited to officers and selected NCOs, probably due to lack of sufficient linguists, but is quite detailed when warranted. The remaining enlisted men apparently are turned directly over to NK police for questioning, processing, and evacuation. Officers remain in military channels back to army level before being released to police custody.

c. Officer Interrogation: The following description of NK officer interrogation methods was obtained from a US Lieutenant from the 24th Division who was one of a group of US and ROK soldiers captured near Pohang by elements of the NK 12th Division on 12 Sept:

1) Initial Processing: At the company CP, an NK soldier recorded the name, rank, and organization of all US personnel. After a wait of 30 minutes, the Lieutenant was marched back to the battalion and later to the regimental CP. At one of these he was asked to fill out a form. Included on this paper was a question as to whether or not he required medical attention and a list giving him as a PW, three choices of action: first, to return to the front and take up arms against UN forces; second, to be released so that he could work his way back to friendly lines; and third, to be interned at a PW camp in Seoul. The lieutenant states that he was not permitted to make a choice.

2) Regimental Interrogation: The lieutenant was subjected to his first interrogation at regimental headquarters approximately six hours after his capture. An NK major interpreter-interrogator did the questioning. He followed a printed form which contained about 250 questions and was divided into several sections. The first group of questions concerned

SECRET SECURITY INFORMATIONAppendix IX
Page 2**SECRET SECURITY INFORMATION**

the organization, strength, and equipment of the interrogees unit and followed a sequence which reminded the lieutenant of US FMs 191-5 and 101-10. The next three groups pertained to logistics, tactics, and the use of combined arms respectively. The following section contained questions of a personal nature. The last group was political in scope and contained such questions as: "How do US EM feel toward cabinet members?" The political affiliations of the interrogee were also taken up here. The entire interrogation lasted approximately three hours. At the conclusion, the lieutenant was informed that he would be given an opportunity to study the works of Engels and Marx in the Seoul internment camp.

3) Division Interrogation: The second interrogation of this officer was conducted at division headquarters and lasted approximately one hour. Questioning was handled by a Soviet army officer dressed in the uniform of an NKA captain. An NK major acted as interpreter. A clerk wrote down answers to the questions in Russian; questioning was done spontaneously without reference to an outline or guide. Queries were non-military in nature and generally covered political subjects. A discussion was conducted into the relative merits of democracy and communism, with the Soviet officer attempting to prove fallacies in the belief that democracy was preferable to communistic concepts. During that time he was assigned to the 19th Infantry Regiment; the interrogator went to a large cardboard file and brought out folders labeled with numerical designations corresponding to the three infantry regiments of the 24th Division. A search of the files revealed that the lieutenant was being carried as assigned to the 34th Regiment. This had been true, as the PW had only recently been assigned to the 19th. A dossier was then removed from the file and the officer was read a complete history of his life, including information which allegedly could only have been obtained for a personal history statement (Form 643) filed in the United States in 1946. At the conclusion of the interview the PW was told that he would be reinterviewed at army level.

4) Corps Interrogation: A third interrogation, lasting 5 to 6 hours was conducted by another NK major at corps headquarters. Parts of this interview were recorded. The major, who stated that he was a former English professor at Seoul University, volunteered the information that he was corps director of propaganda and that his duties included the organizing of propaganda programs aired over Radio Seoul. He explained that UN prisoners were required to read prepared statements to the effect that they were receiving good treatment. According to the US officer, these recordings were generally accomplished at the point of a gun to preclude deviations from the script. The interrogation conducted at this level was apparently another effort to persuade the interrogee to re-examine his political ideology. Great pains were taken to explain the basic concepts of communistic doctrine. The

Appendix IX
Page 3**SECRET SECURITY INFORMATION**

