

*455 L. Service Bureau, Compatible U.S. Model*

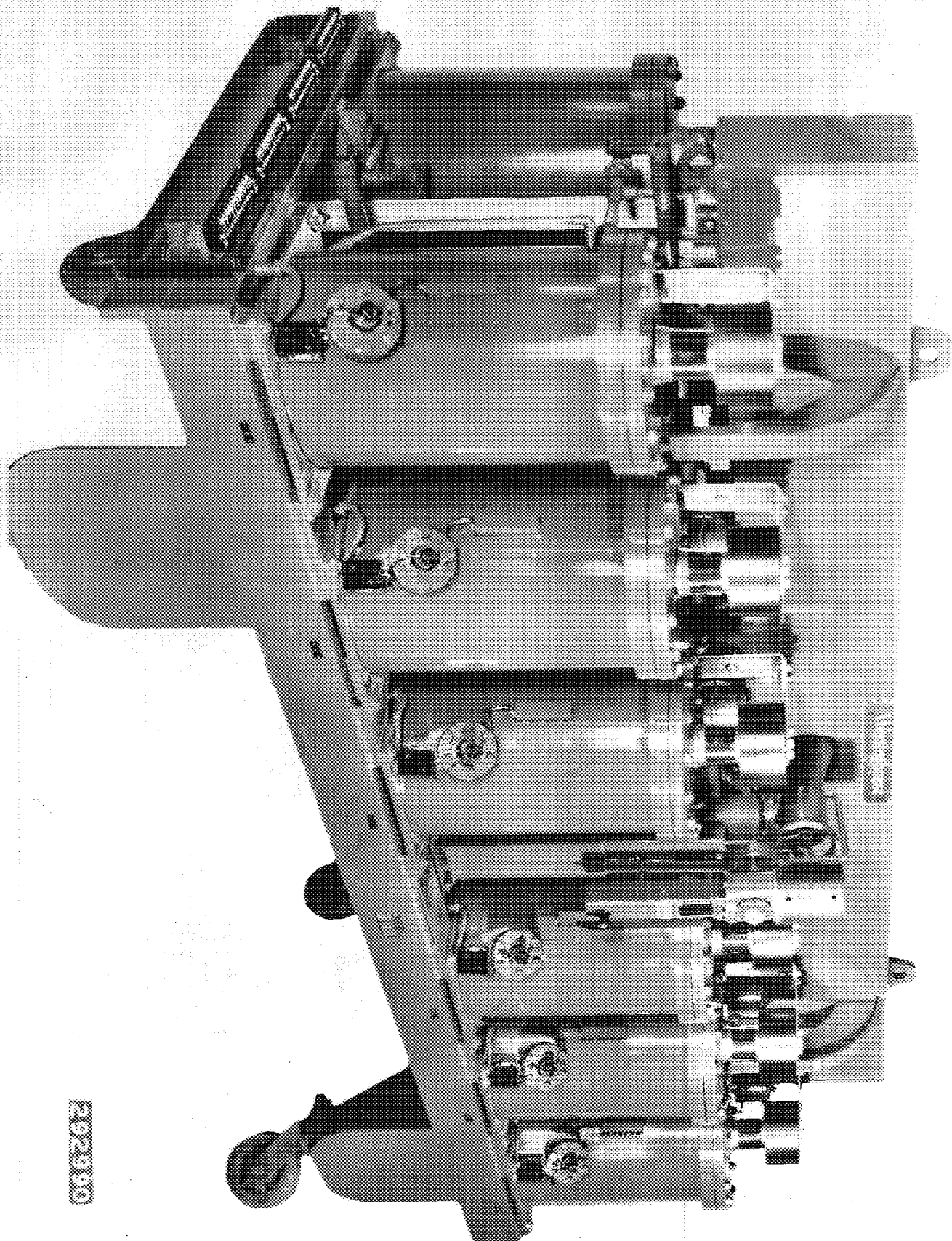

202990

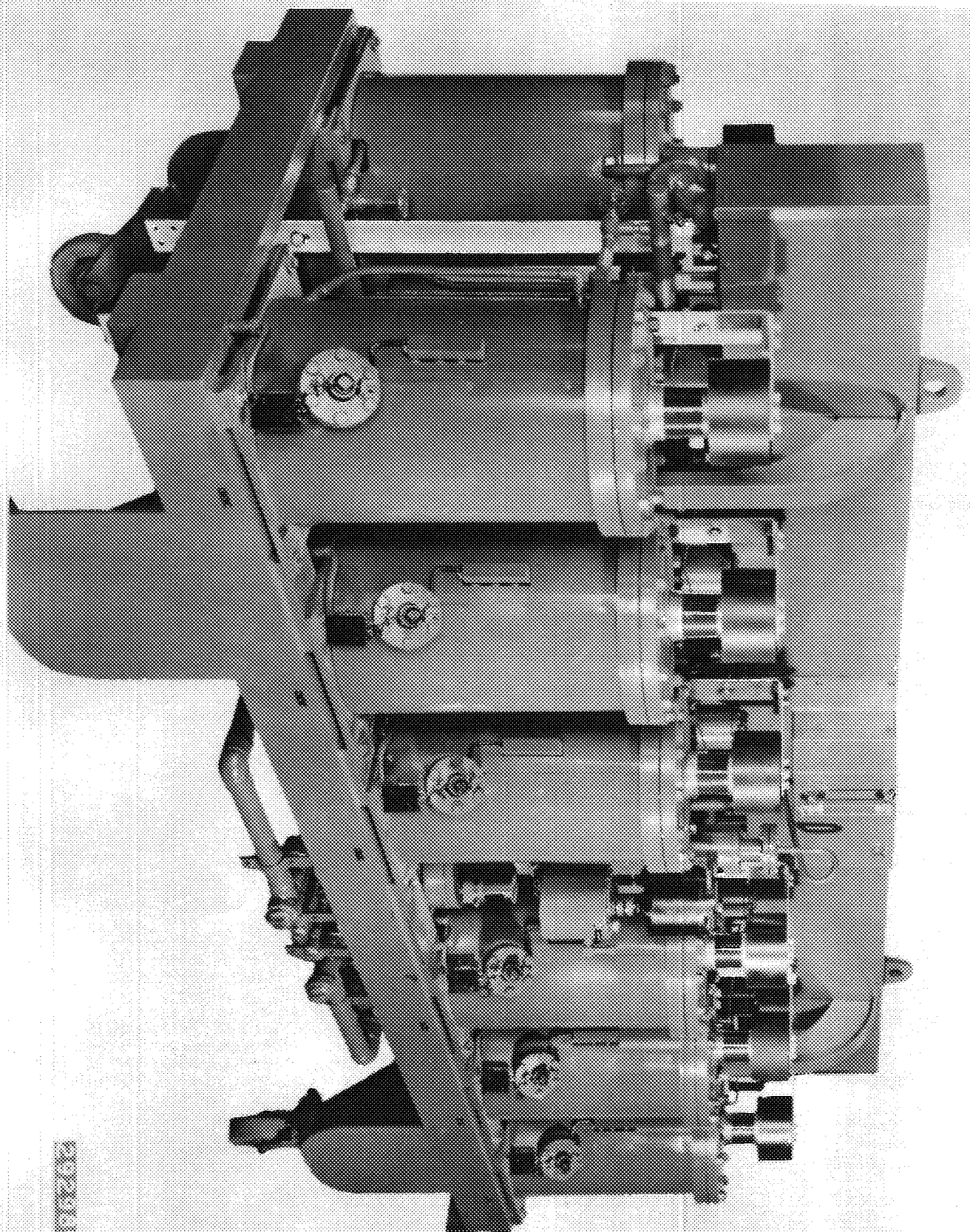

SECRET

AP



*Westinghouse*

# PUMPED IGNITRON RECTIFIERS





# IGNITRON

*Mercury arc*

# RECTIFIERS

Page

Efficiency . . . . .	6
Operating and Maintenance Economy . .	7
Overload Capacity . . . . .	8
Solution To "Arc-Back" Problem . . . .	8
Voltage Control . . . . .	9
Ease of Installation . . . . .	9
Portability . . . . .	10
Photo-Review of Typical Installations . .	11
Principle of the Ignitron Rectifier . . . .	18
Construction of the Ignitron Rectifier . .	22
Auxiliaries of the Ignitron Rectifier . .	28

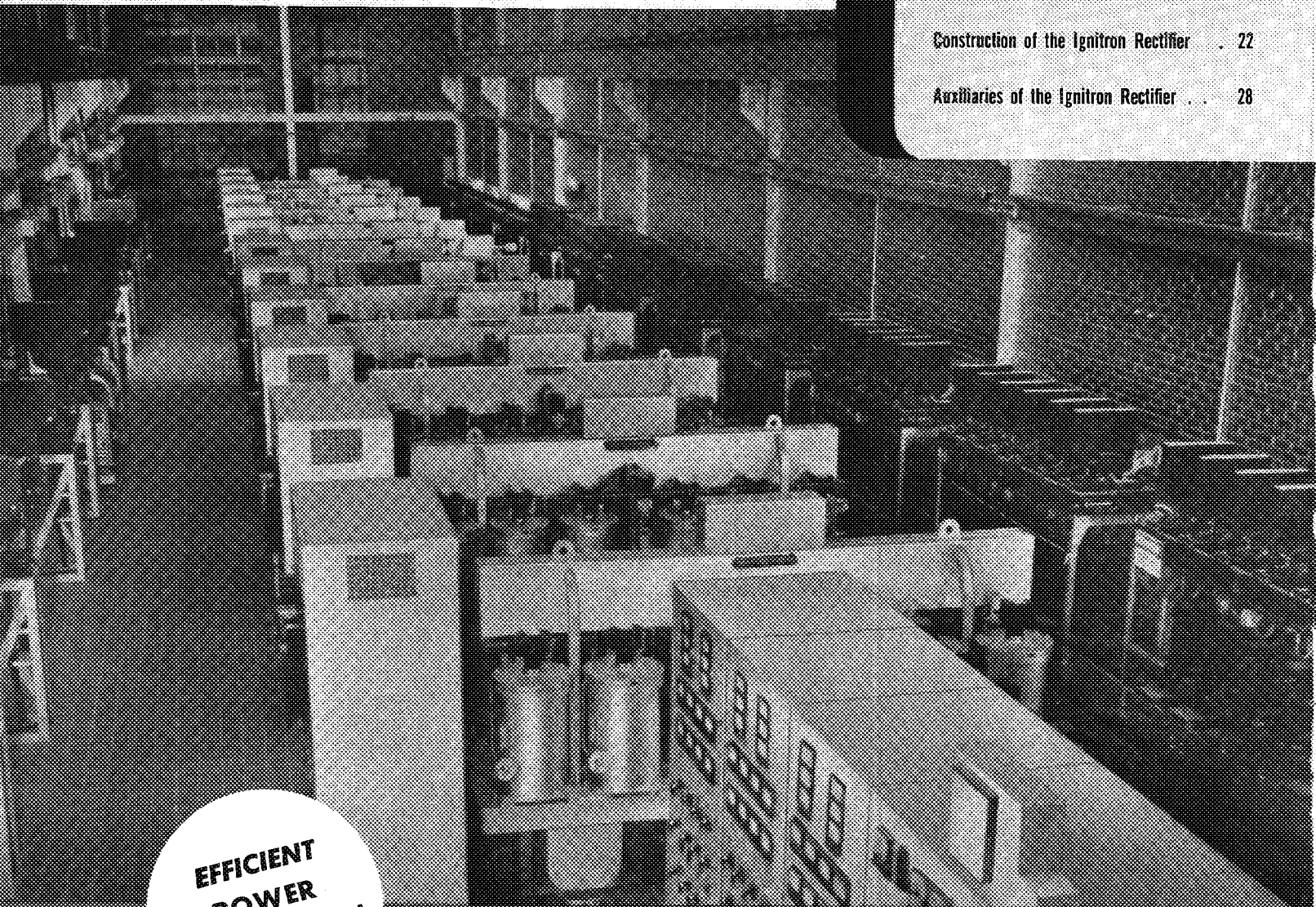

**EFFICIENT  
POWER  
CONVERSION**

FOR RAILWAYS + MINING + ELECTROCHEMICAL PROCESSES +

STEEL MILLS AND GENERAL INDUSTRIAL PLANTS

efficient, dependable power conversion is IMPORTANT

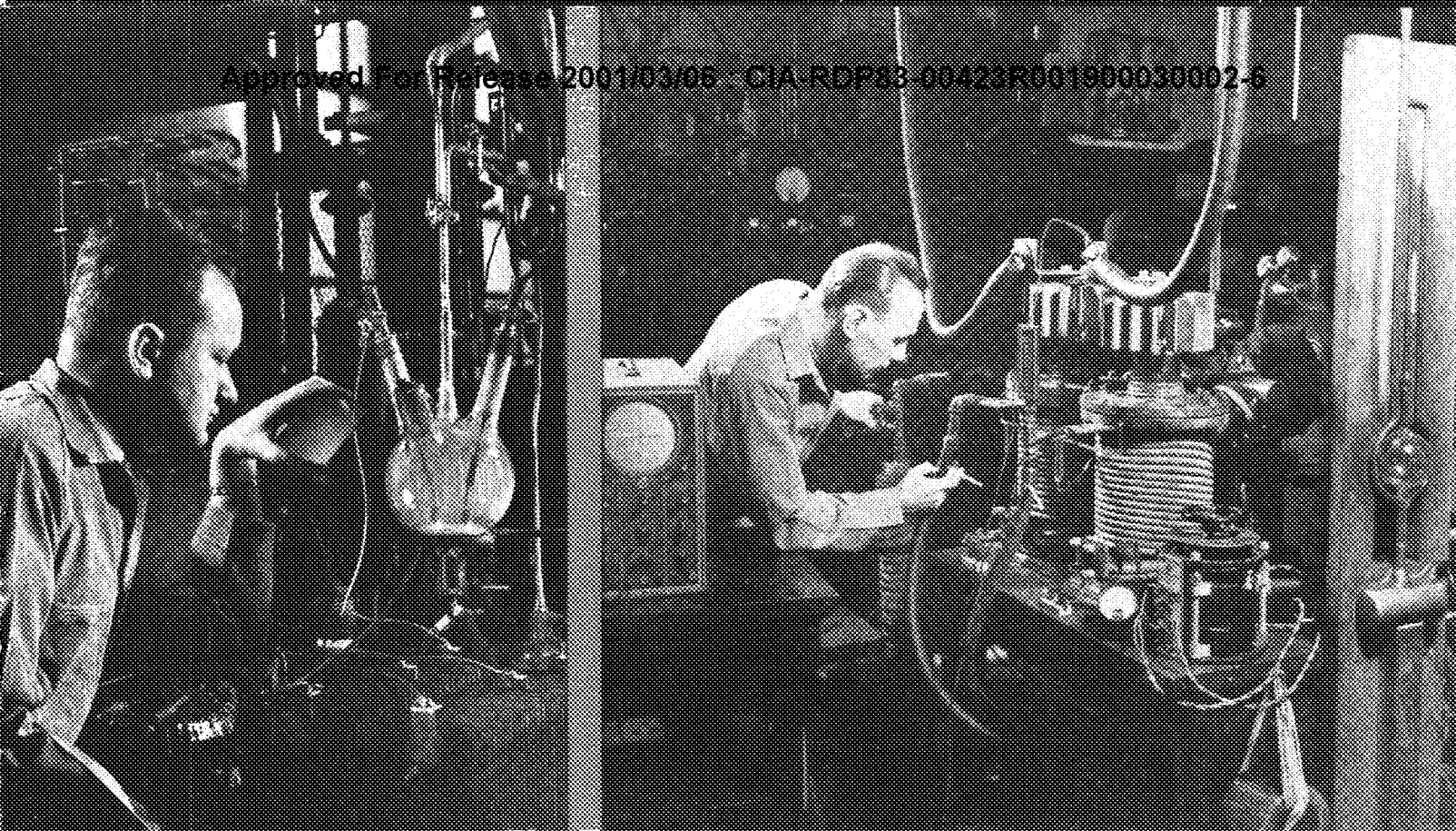

## **ANOTHER PRODUCT OF WESTINGHOUSE RESEARCH SPEEDS INDUSTRIAL PROGRESS**

From the original idea to the installed and working unit, the IGNITRON RECTIFIER is a product of Westinghouse research. It is another—and important—link in the long chain of Westinghouse developments in the field of generation, transmission and conversion of electrical power. Westinghouse research in these fields has been continuous for more than a half century. Ignitron is exclusively a Westinghouse contribution to the progress of modern industry.





◀ 120,000-ampere, 673-volt Ignitron Rectifier installation for electrochemical service.

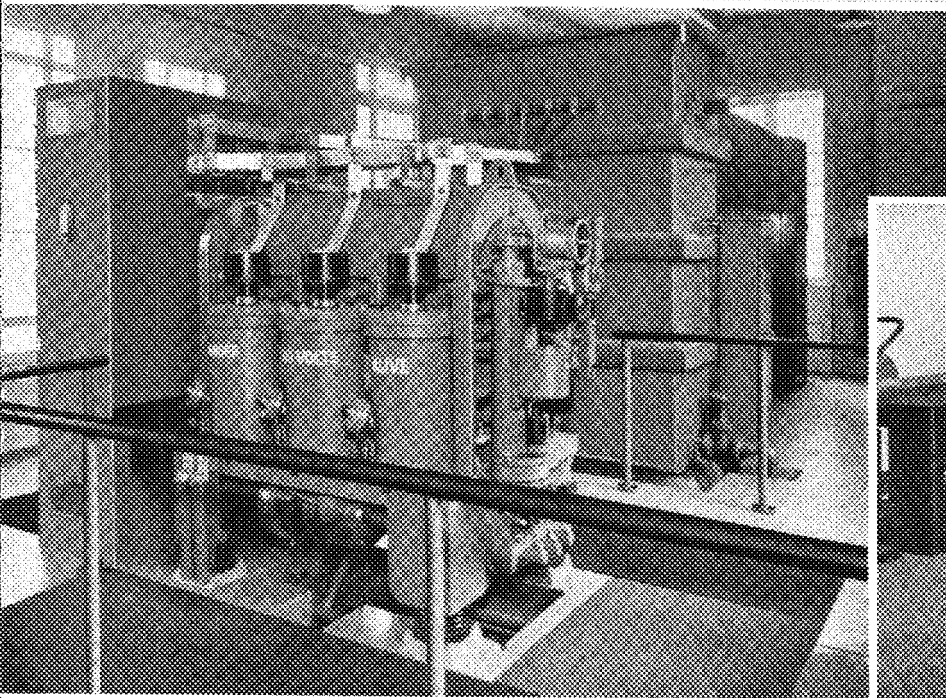

◀ 1000 kw, 600-volt Ignitron Rectifier for city transit service.

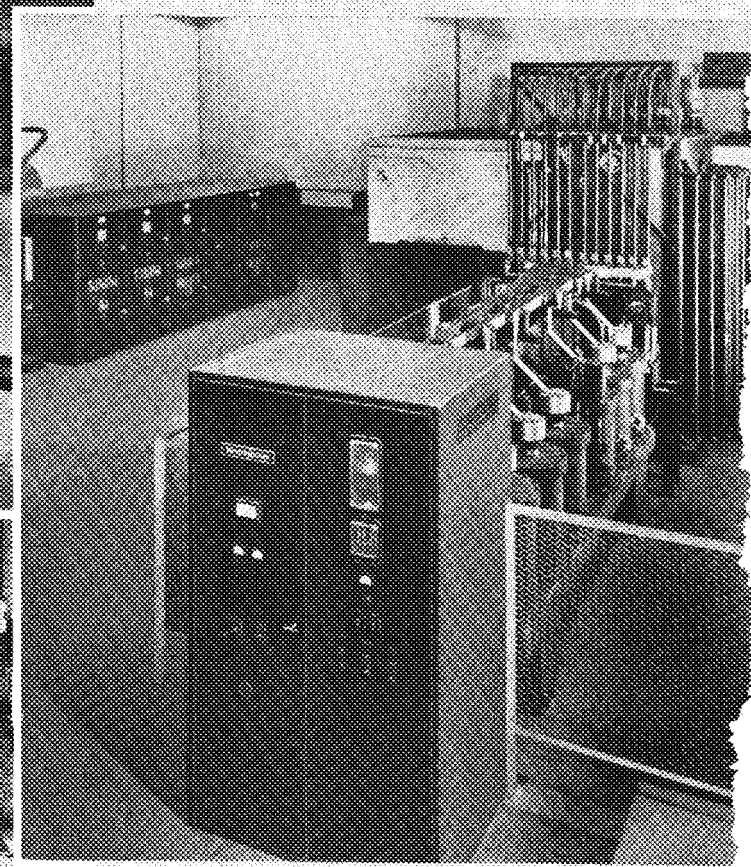

▲ 1000 kw, 250-volt Ignitron Rectifier for steel mill service.

◀ 750 kw, 250-volt Ignitron Rectifier for steel mill service.

# IGNITRON

MEANS HIGH EFFICIENCY . . . LOW COST . . . A  
PRACTICAL, TESTED-AND-PROVED SOLUTION  
FOR POWER CONVERSION PROBLEMS IN  
THE 250-3000 VOLTAGE RANGE

IGNITRON RECTIFIERS introduce a basically new principle in the utilization of the rectifying property of the mercury vapor arc, which greatly increases the efficiency of power conversion in the 250-3000-volt range. Under this new principle it is possible to design a rectifier which more nearly approaches the theoretical efficiency of the mercury arc.

Improved efficiency and added economy, maximum availability and long-time dependability are designed into the Ignitron Rectifier. Not only is the scope of mercury arc rectifiers extended to include the lower voltage range, but new high standards of performance are attained as a result of the basic improvement in design and operating principle.

The original cost of Ignitron power conversion equipment compares favorably with that of rotating types. Real savings are to be had in installation, operation, and maintenance. An investment in Ignitron Rectifiers becomes increasingly profitable.





# HIGH EFFICIENCY

The fundamental method of operation of the Ignitron with its intermittent excitation system and individual tubes for the anode and cathode is responsible for the high efficiency. By the reduction in shields and arc length, the Ignitron reduces arc drop and provides increased efficiency. The curves here show the efficiency advantage of the Ignitron over synchronous converters and motor-generator sets.

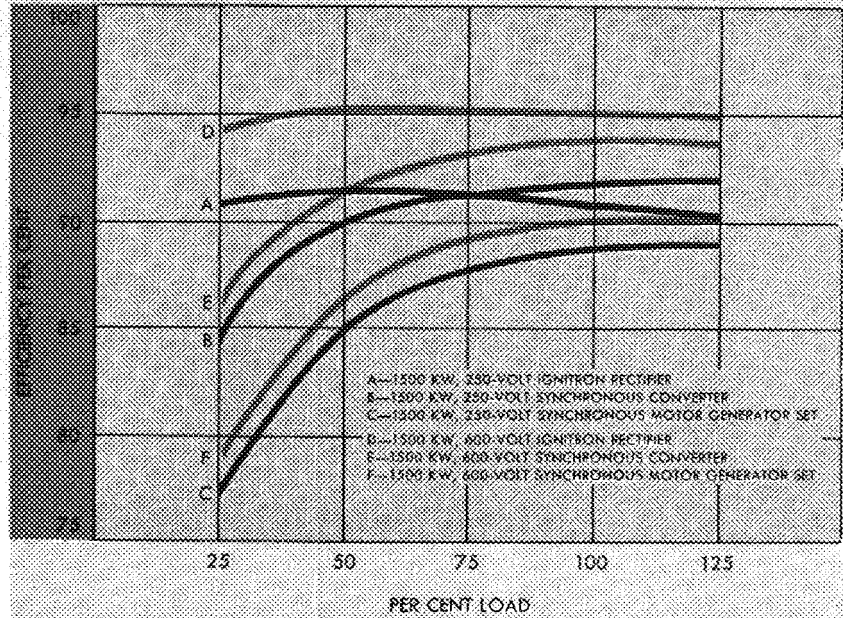

# HIGH EFFICIENCY maintained over entire load range

Uniformly high efficiency over the entire load range is a characteristic of the Ignitron Rectifier which offers decided advantages in many applications. For constant 24-hour loads the higher efficiency of the Ignitron Rectifier is of great importance. For highly fluctuating loads Ignitron Rectifiers contribute to economy of operation by maintaining their high efficiency under light load conditions.

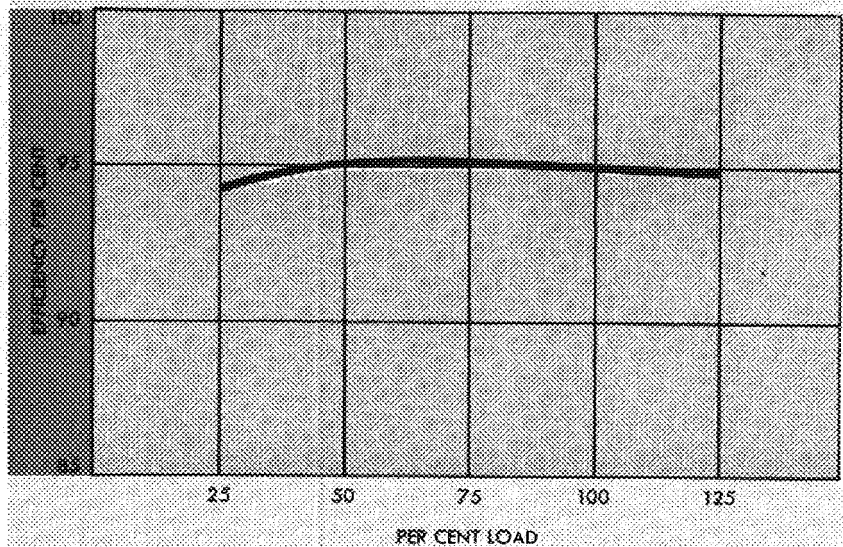

## LOW *Operating* COSTS

Low arc-drop loss and resulting high efficiency . . . simplified, automatic operation . . . freedom from problems of high starting demand, synchronization and reverse current . . . these factors contribute directly to greater operating economy in Ignitron Rectifiers. In contrast to rotating equipment, Ignitron Rectifiers require no special air cleaning or ventilating service.

They do not require bearing or commutator maintenance. Regulation and control are simple, and for the most part automatic. Near-100% availability of power when needed likewise contributes to operating economy, by avoiding costs incidental to delays and stoppages. An Ignitron Rectifier is always ready to deliver power instantly, at any load demand.

## LOW *Maintenance* COSTS

Many features and characteristics inherent in the simplified principle of operation of the Ignitron Rectifier provide reduced maintenance costs. These include:

1. Absence of commutators, brushes, collector rings or bearings which require periodic maintenance and replacement.
2. Absence of windings subject to deterioration.
3. Operation of interior parts in a near perfect vacuum.
4. No parts requiring periodic replacement.
5. Cooling system protected against corrosion.

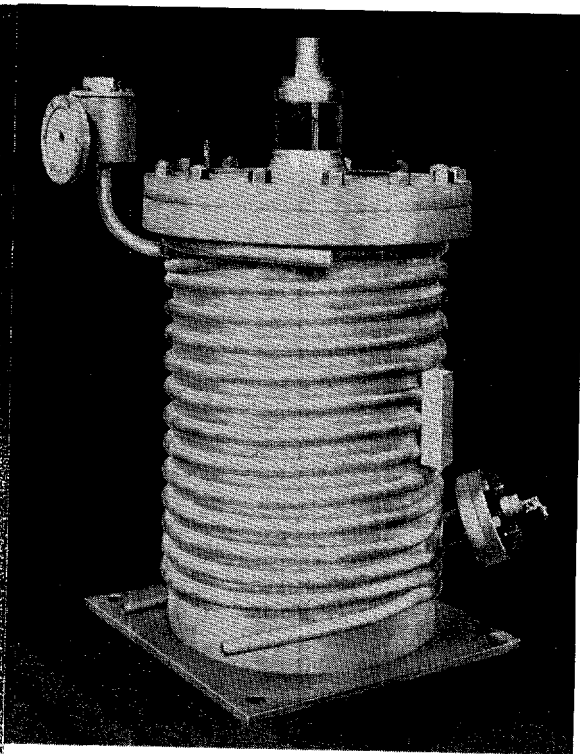

Ignitron tube showing copper cooling coils.

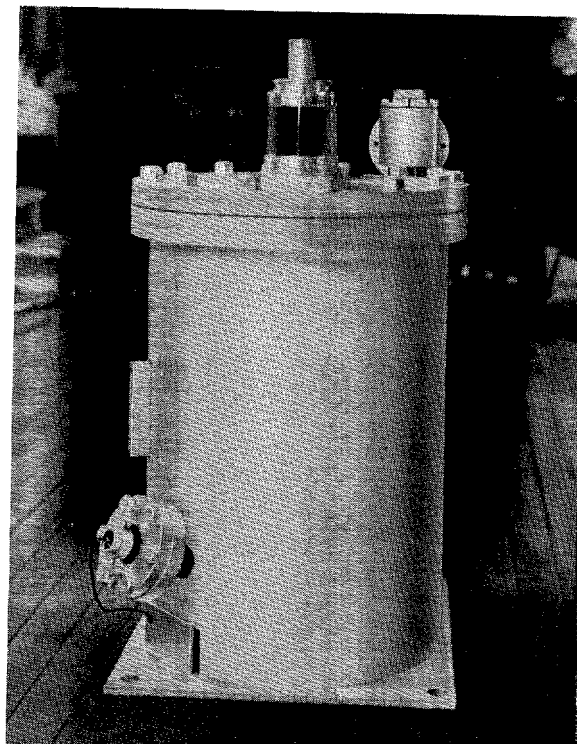

Finished Ignitron tube with cover over coils.



# *High Short-Time* **OVERLOAD CAPACITY**

Since the only effect of an excessively high current in an Ignitron Rectifier is the generation of heat with increased vaporization of mercury, a momentary overload or even a short circuit cannot damage the equipment. Provided the overloads are removed within a reasonable time, the Ignitron will readily handle applica-

tions involving high load swings. Load shifting is very seldom necessary. This unusual ability to handle high overloads for reasonable periods of time makes the Ignitron particularly well suited to such service as coal mining, street railway, steel mill and other applications involving overload and short-circuit conditions.

# *Arc-Back* **PROBLEM SOLVED**

"Arc-back" occurs occasionally in all mercury arc rectifiers. In the multi-anode tank type, this tendency can be curbed only by the use of grids and shields. This solution of the problem, however, increases arc voltage drop and thus impairs the rectifier efficiency. In the Ignitron Rectifier, the arc is extinguished and the source of ionization eliminated during the half-cycle when the anode must withstand high reverse voltage. The distance between anode and cathode can be decreased, grids and shields can be reduced. The Ignitron thus offers higher efficiency with increased reliability.

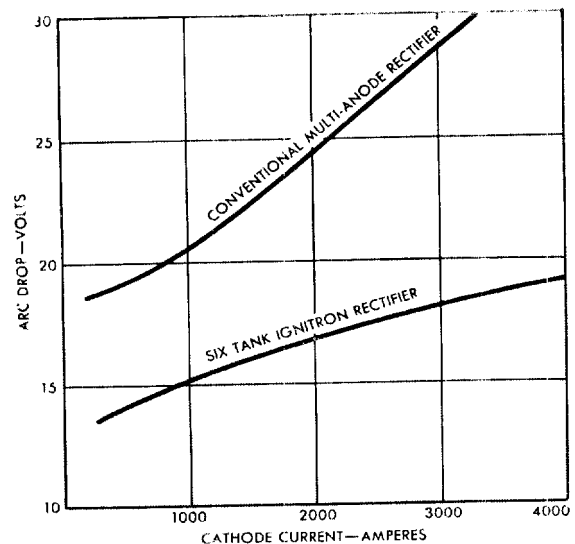

# VOLTAGE *Control*

Simple, positive control of the d-c voltage of an Ignitron is effected by delaying the pickup time in the cycle of the anodes—which is accomplished by shifting the ignition impulse. Pickup can be placed at the exact point in the cycle which will give the desired voltage reduction. In other words, the normal direct-current voltage characteristic of the Ignitron can be reduced as desired by delaying the action of the ignitors in starting the arc to a phase position other than normal. This delay can be accomplished manually or automatically, to provide smooth, fast variation in output voltage.

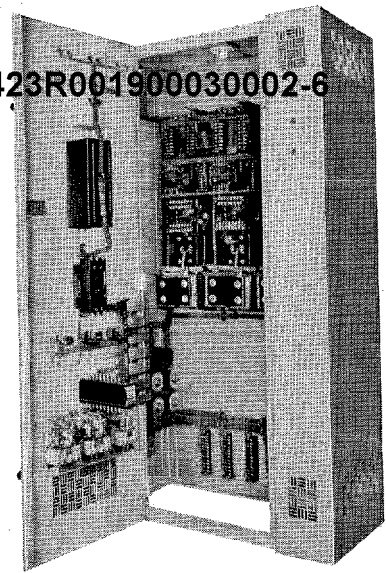

Auxiliary control cubicle, which houses the Ignitron excitation equipment. Open view is shown above; closed view below.

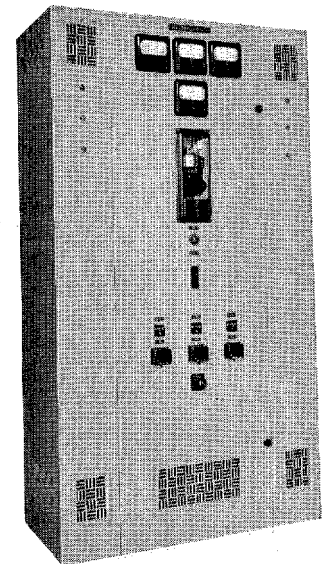

# *Ease* OF INSTALLATION

An Ignitron Rectifier is installed simply by placing it on a normal strength, reasonably level floor. No special foundations are required because of its lightweight construction and vibration-free operation. Installation consists simply of putting the unit in place and connecting the control leads, power leads and water supply. Auxiliary apparatus is mounted in a separate cubicle which is completely wired. The cubicle is usually mounted adjacent to the Ignitron assembly, however it may be located in the switchgear lineup if desired. No air ducts, ventilation systems or noise suppressors are required. When installation expense is included, the installed cost of the Ignitron is generally below that of rotating equipment.

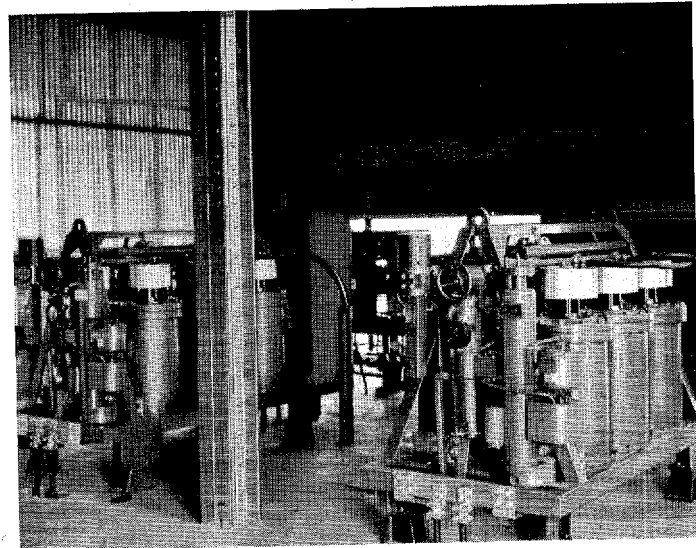

View showing simplicity of installation.



# *Quiet* **OPERATION**

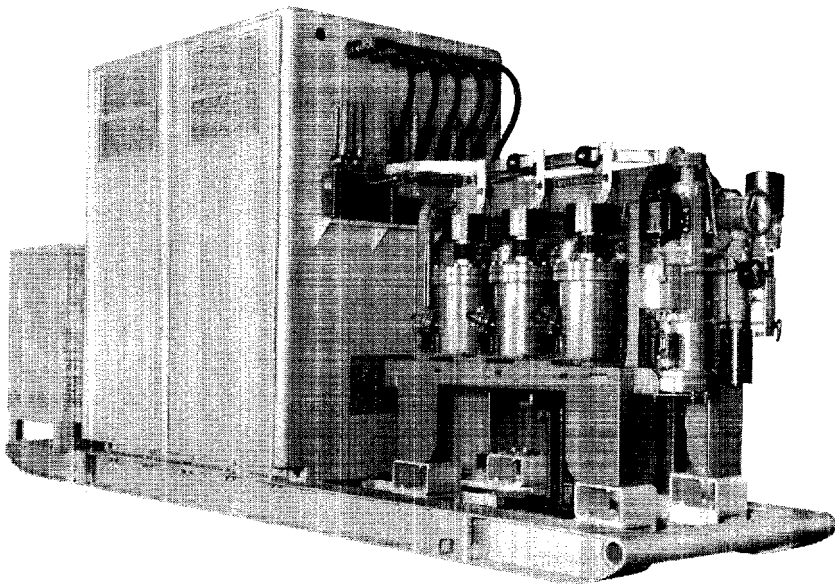
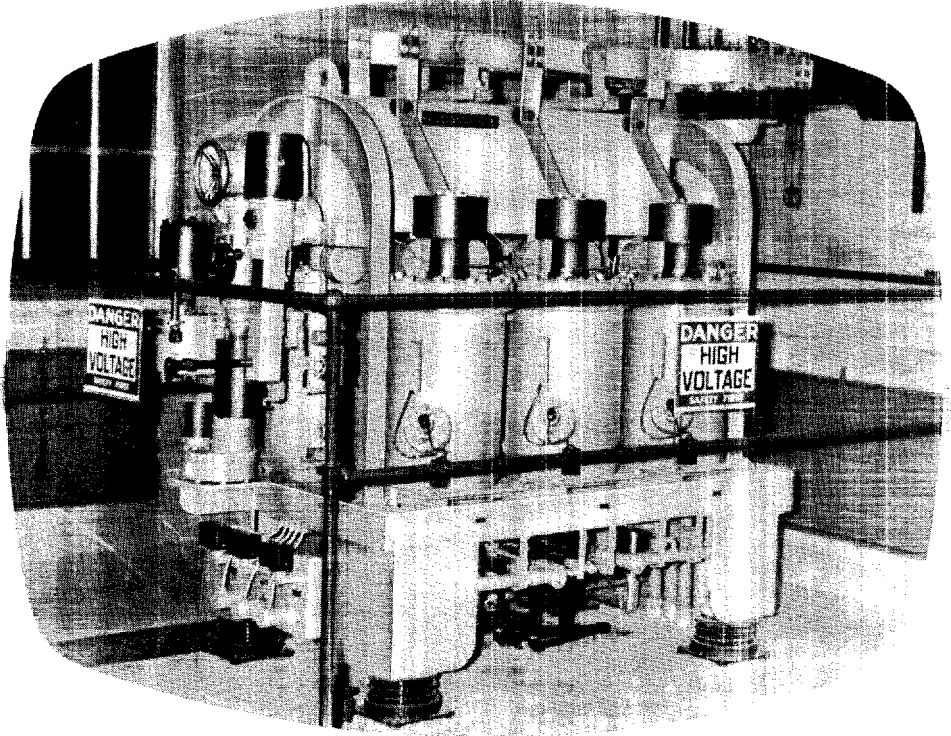

With no rotating or moving parts except the rotary vacuum pump and the centrifugal water-circulating pump, the Ignitron Rectifier is remarkably quiet in operation. Where substations must be maintained in office buildings or residential districts, this quiet operation is a very real advantage that means much in good will.

Skid-mounted Ignitron Rectifier designed for ease in changing substation locations.

## **LIGHTWEIGHT • COMPACT • PORTABLE**

Though sturdy in construction, the Ignitron Rectifier is lightweight and compact. Complete rectifier and associated apparatus can be mounted on skids for portability, and the entire power conversion unit then can be moved to new locations as the d.c.

load center changes. The compactness of the Ignitron in relation to its rating is a decided advantage where space is at a premium. In cases where existing stations are already crowded, rectifiers can be installed on balconies without any difficulty.

# PROOF:

**SERVICE RECORDS...ENTHUSIASTIC  
ACCEPTANCE...PROVE THE OVER-ALL  
ADVANTAGES OF POWER CONVERSION  
BY IGNITRON RECTIFIERS**

The Ignitron Rectifier was introduced by Westinghouse in 1937, and the first installation was made early in that year. In less than 12 years, well over 4,000,000 kw of Ignitrons have been purchased. New capacity is being added at a constantly increasing rate. On the following pages are illustrated typical installations in railway, mining, power, general industrial and electrochemical service. Much of the factual data in this book has been assembled from the fine performance records of these installations and the many other Westinghouse Ignitrons in use today.

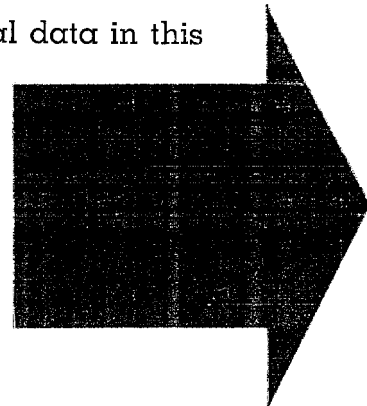

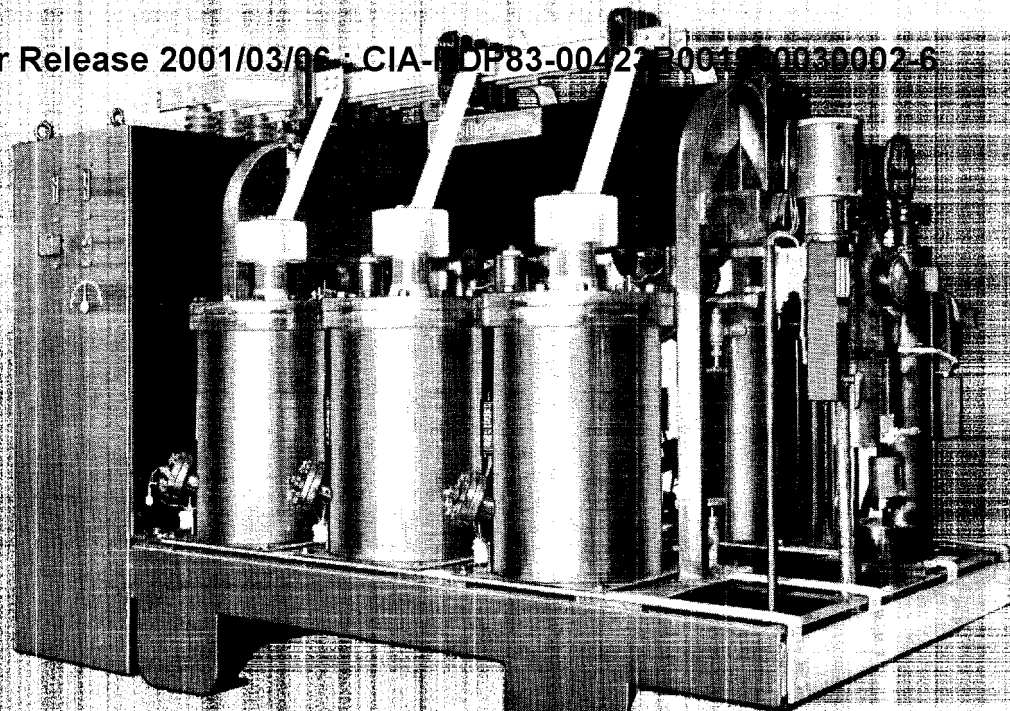

## *Railways*

Ignitron Rectifiers found quick acceptance in electric railway service. Of utmost importance, Ignitron Rectifiers operate at high efficiency particularly at light loads. They give high over-load capacity and instant availability.

12

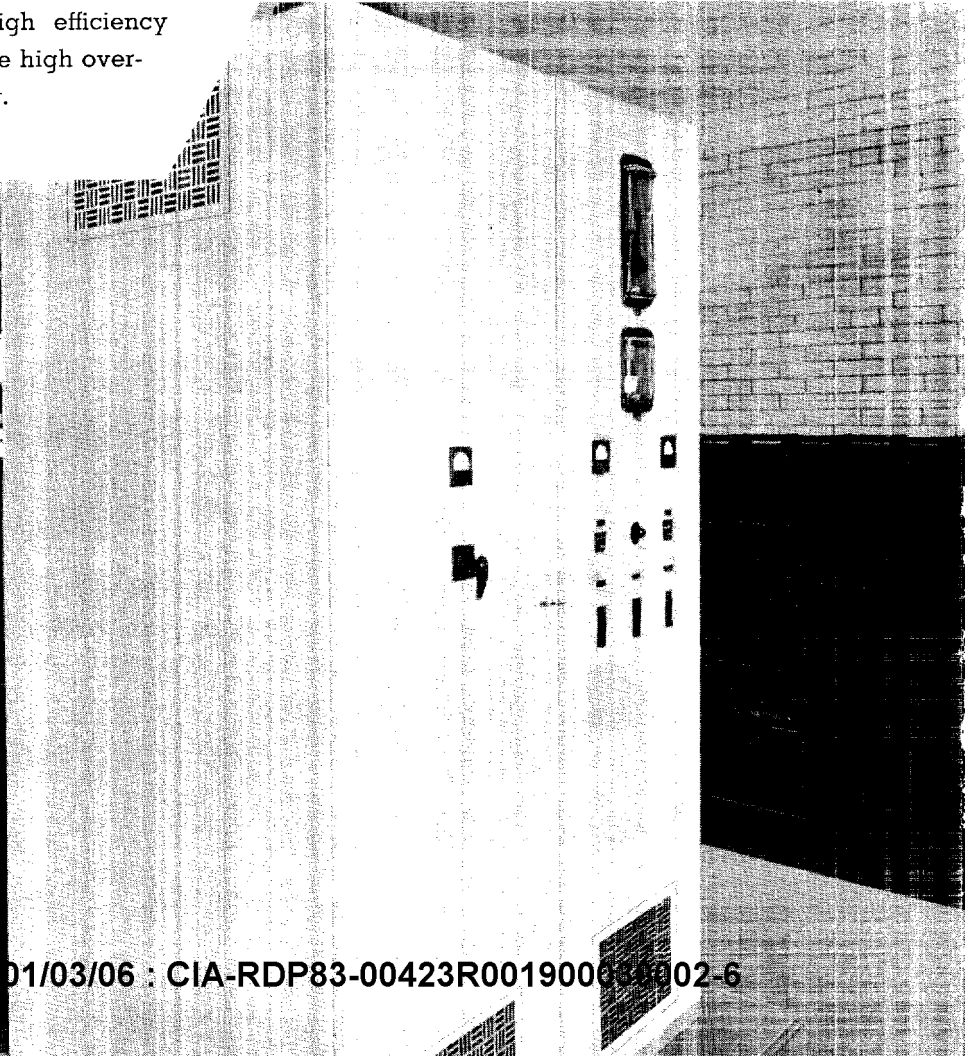



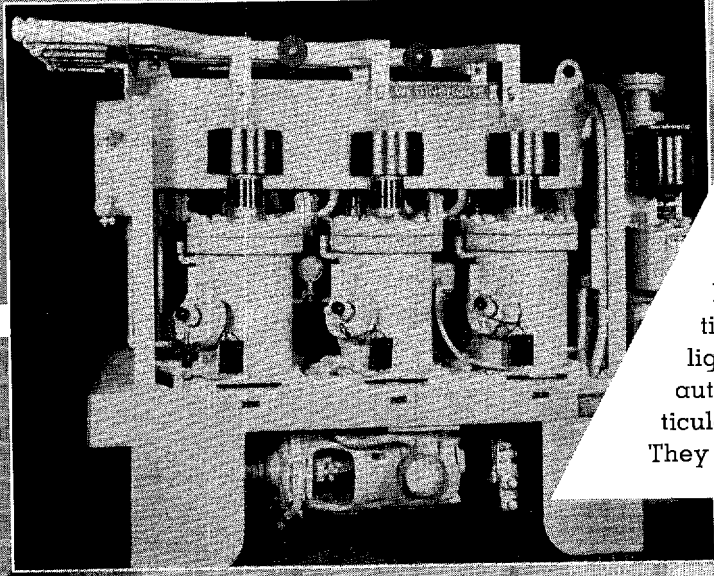
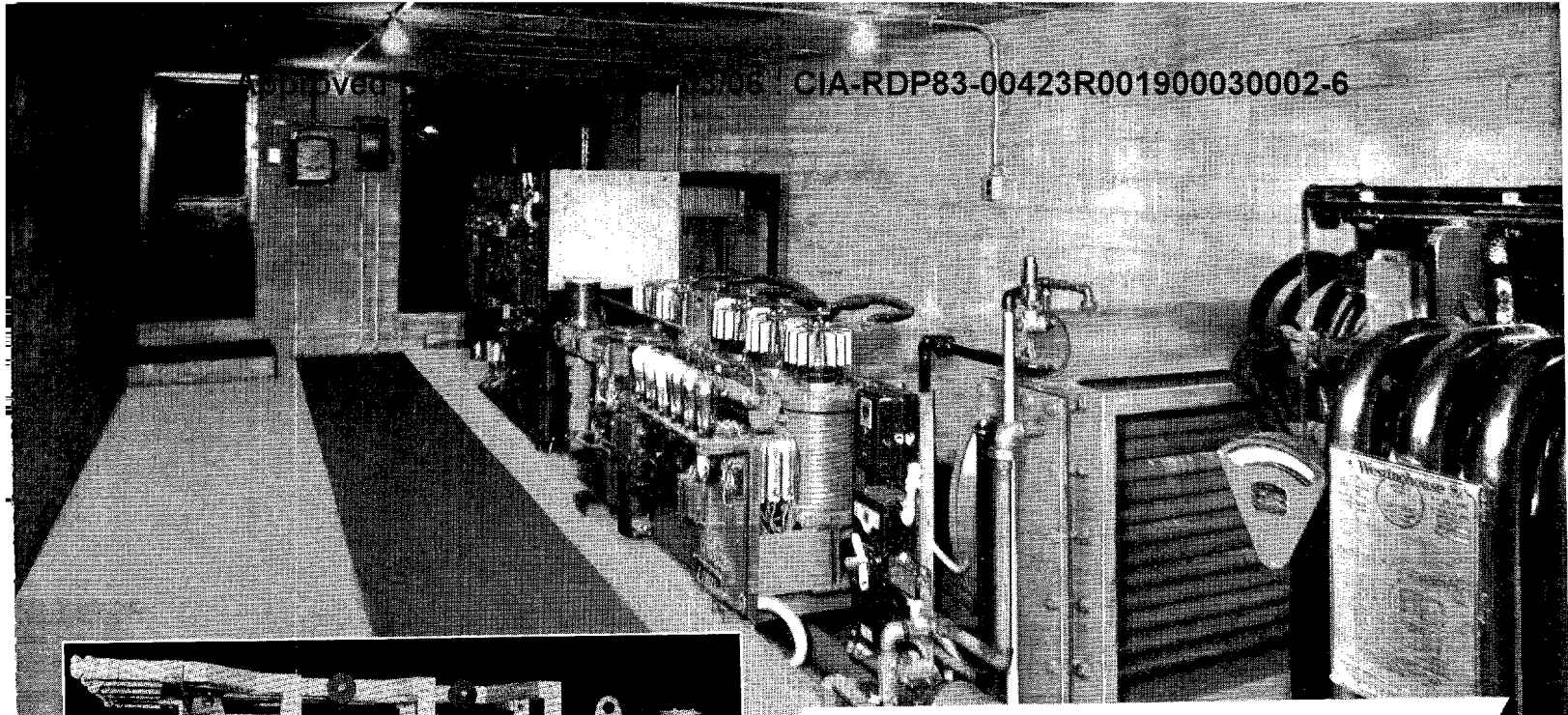

# Mining

In addition to high efficiency, and high overload capacity, mining service requires installation in isolated places and low headroom. Being lightweight, compact, and readily adaptable to automatic control, Ignitron Rectifiers are particularly suited to the needs of mining service. They can be installed in isolated places.

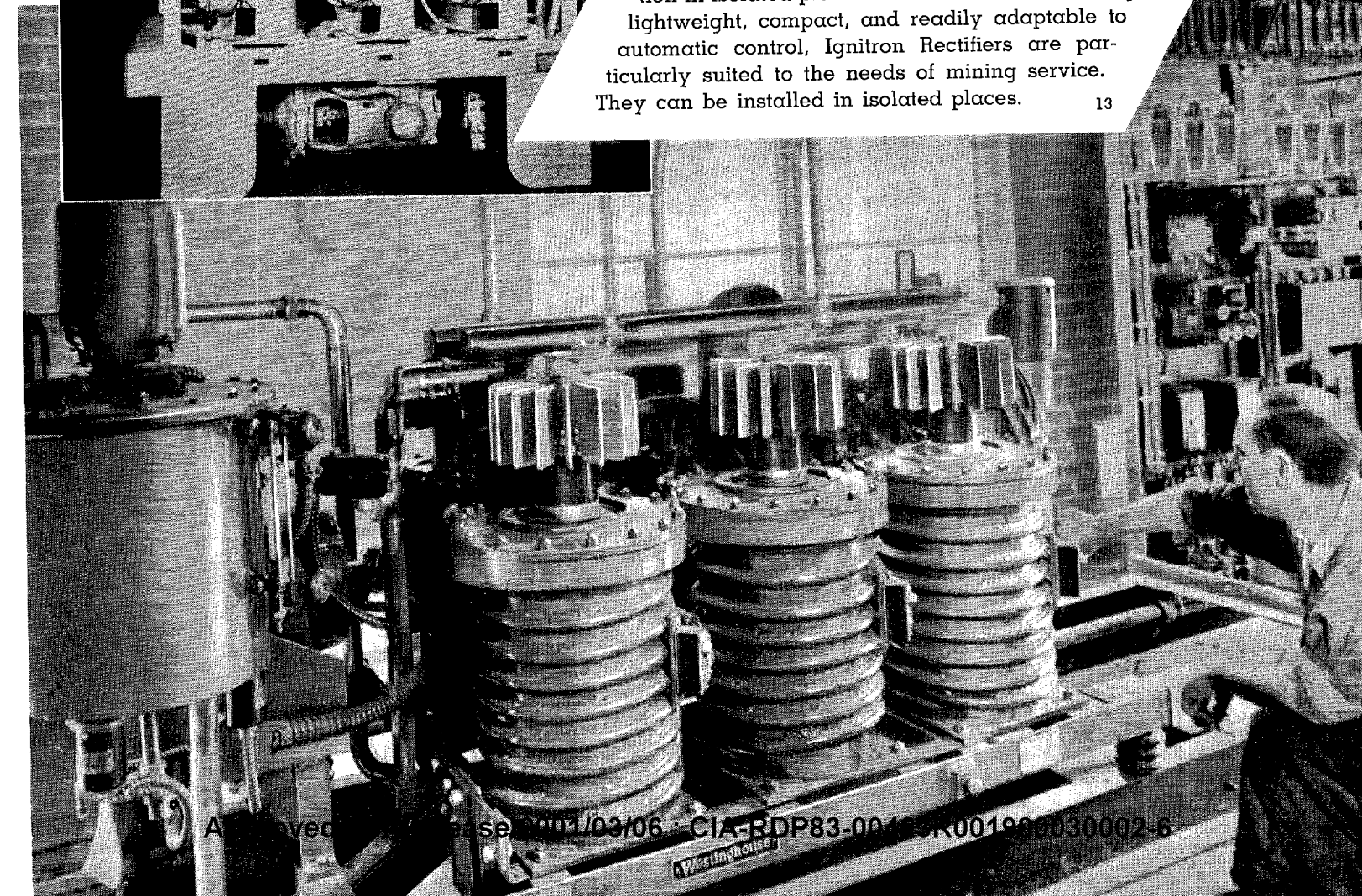

# *Electro- Chemical Processes*

14

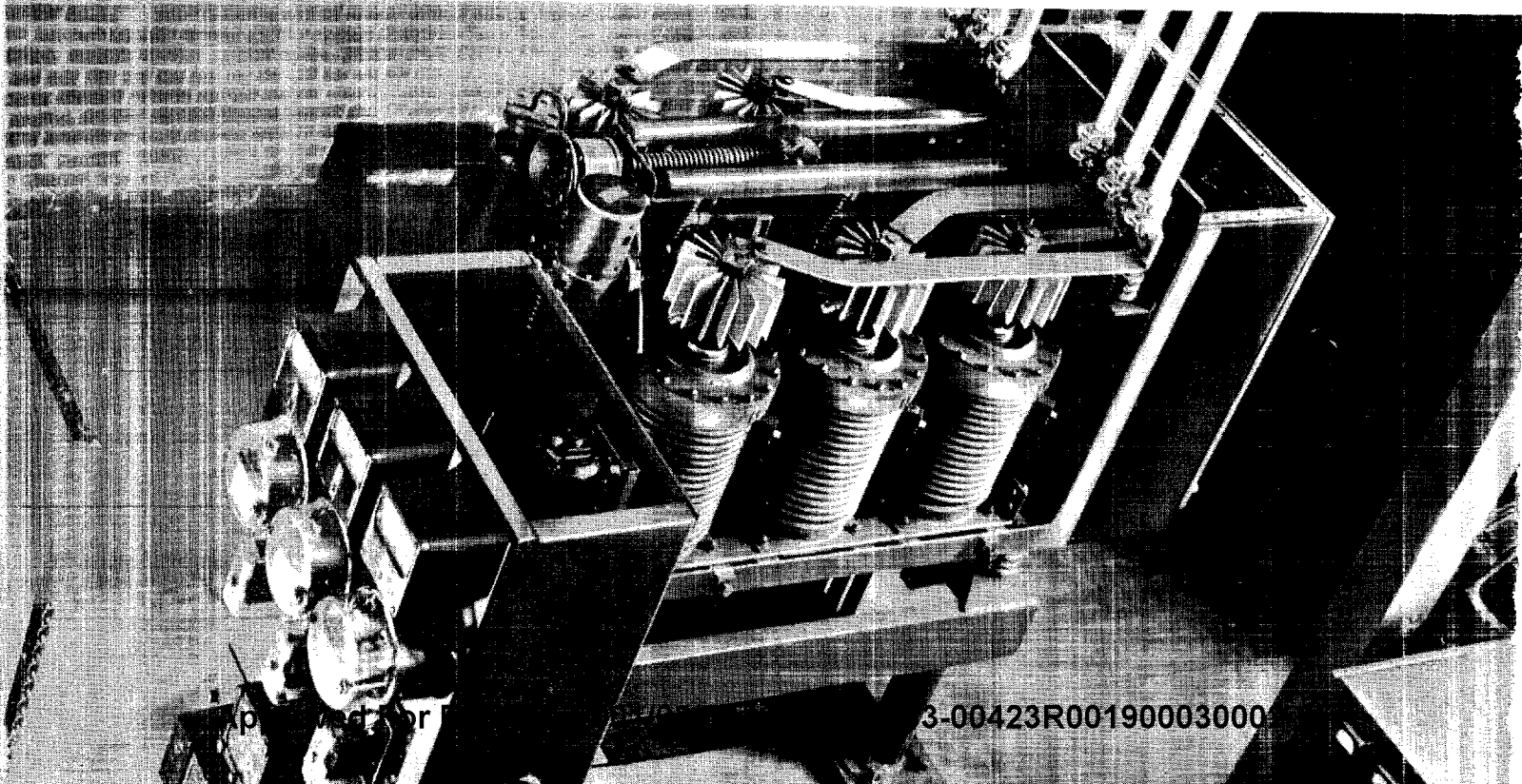
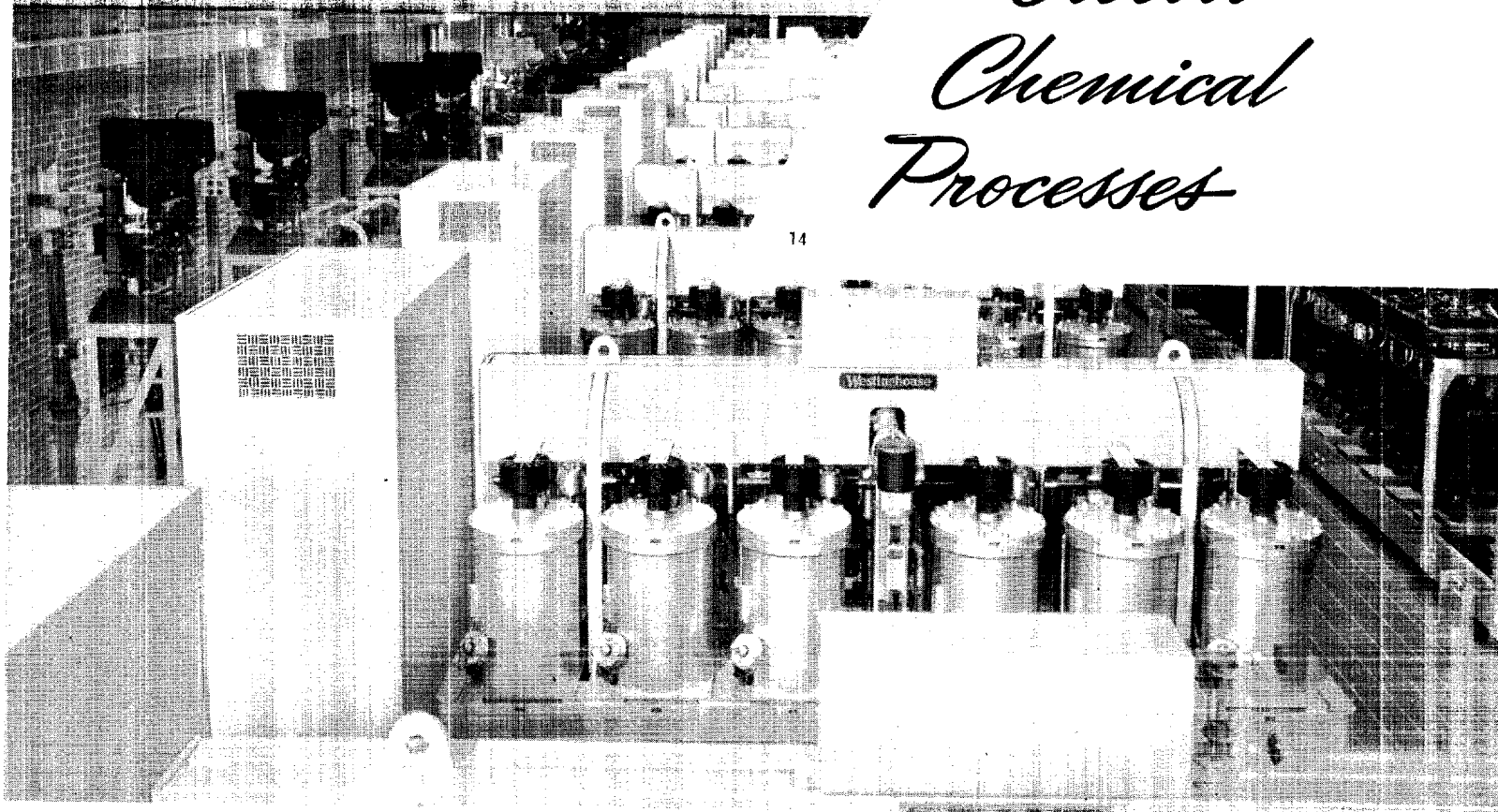



In the electrochemical field, where load is maintained continuously at full capacity, Ignitron Rectifiers have undergone possibly the most severe tests that could be devised for power conversion equipment. Proof that they can carry heavy loads continuously, with minimum maintenance, is found in the increasing number of applications in this field.

15

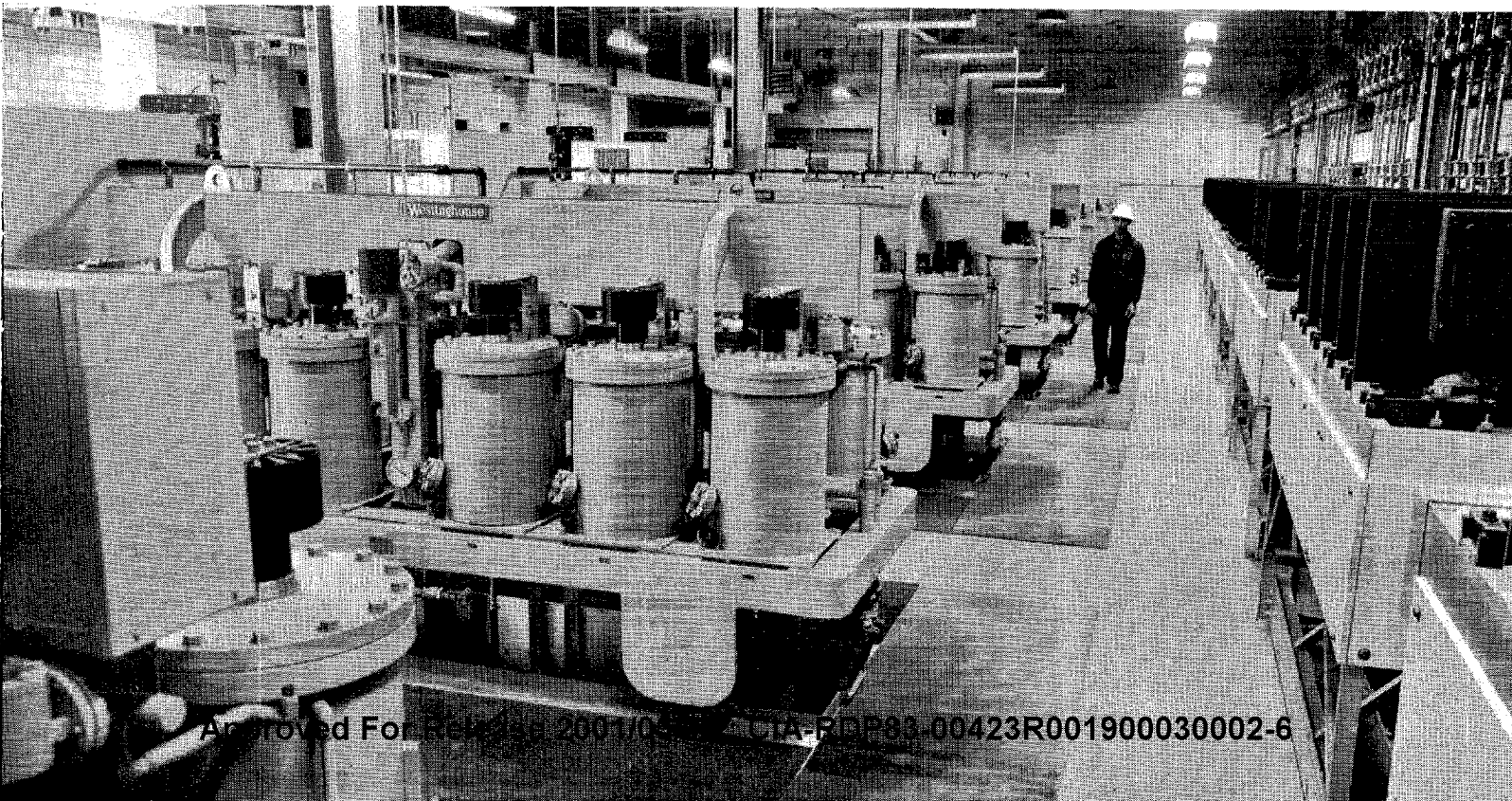
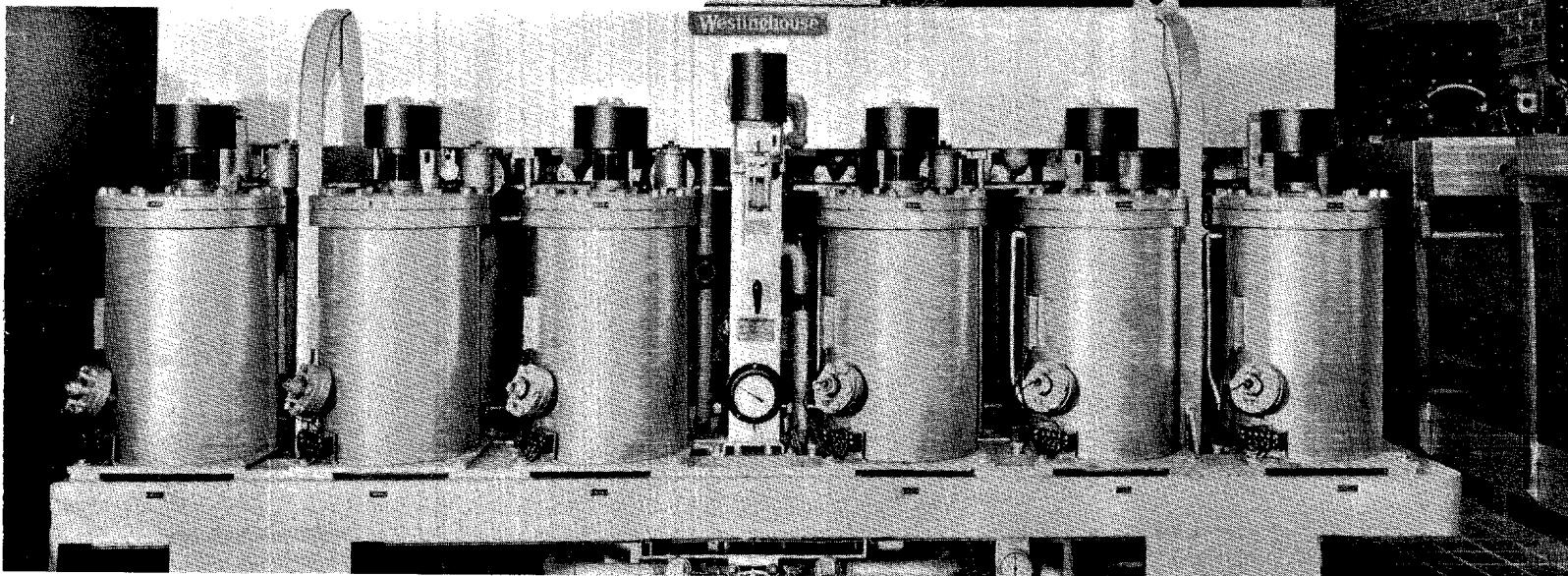



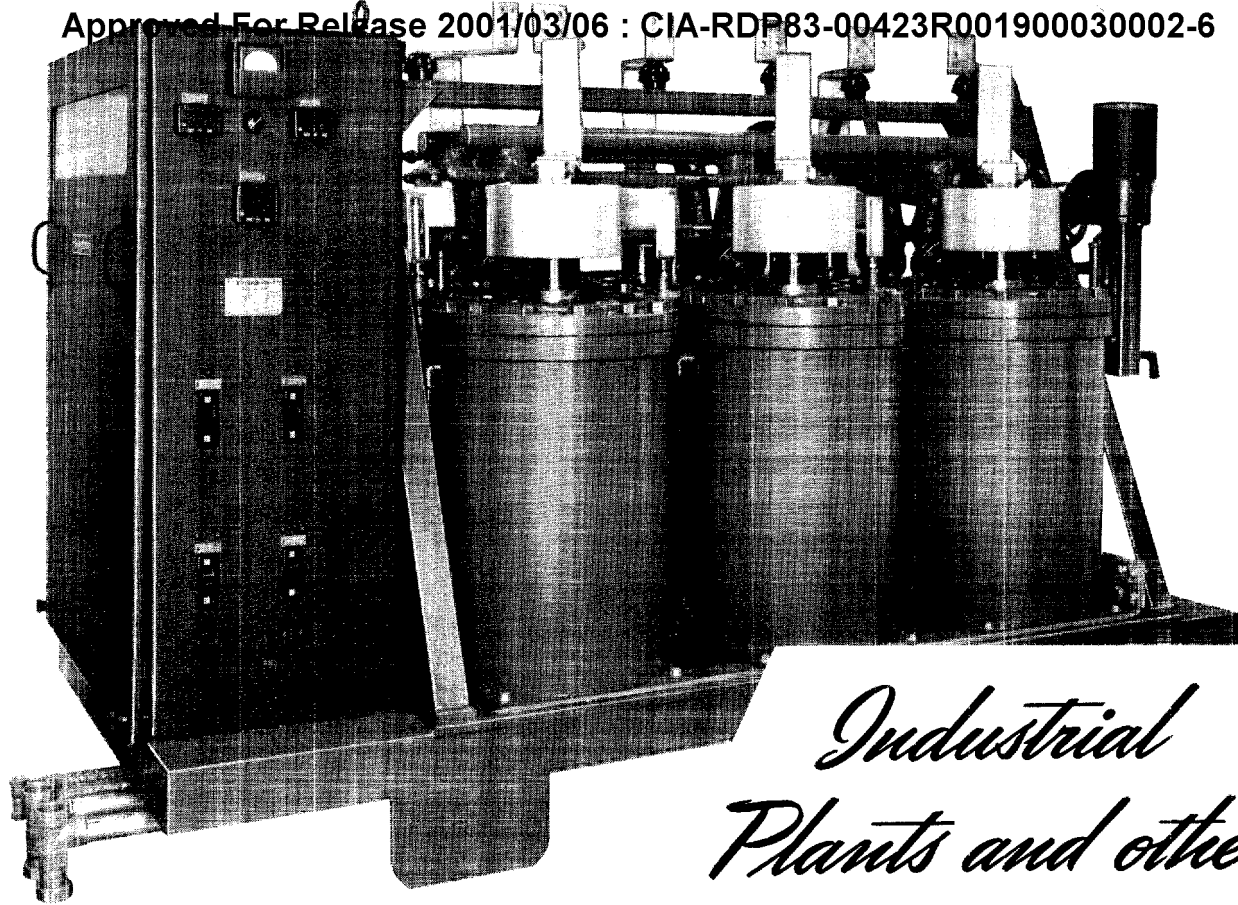

## *Industrial Plants and other Applications*

Industry in general—wherever there is need for power conversion in the range below 3000 volts—select the Ignitron Rectifier because of its ease of installation, availability factor, and high overload capacity. Low operating costs and low maintenance costs help reduce the total cost of direct-current power.

16

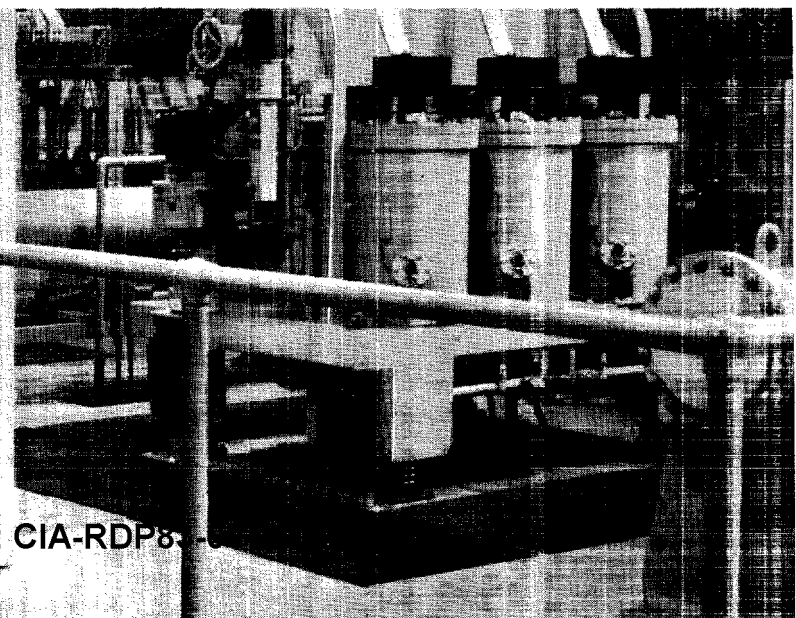
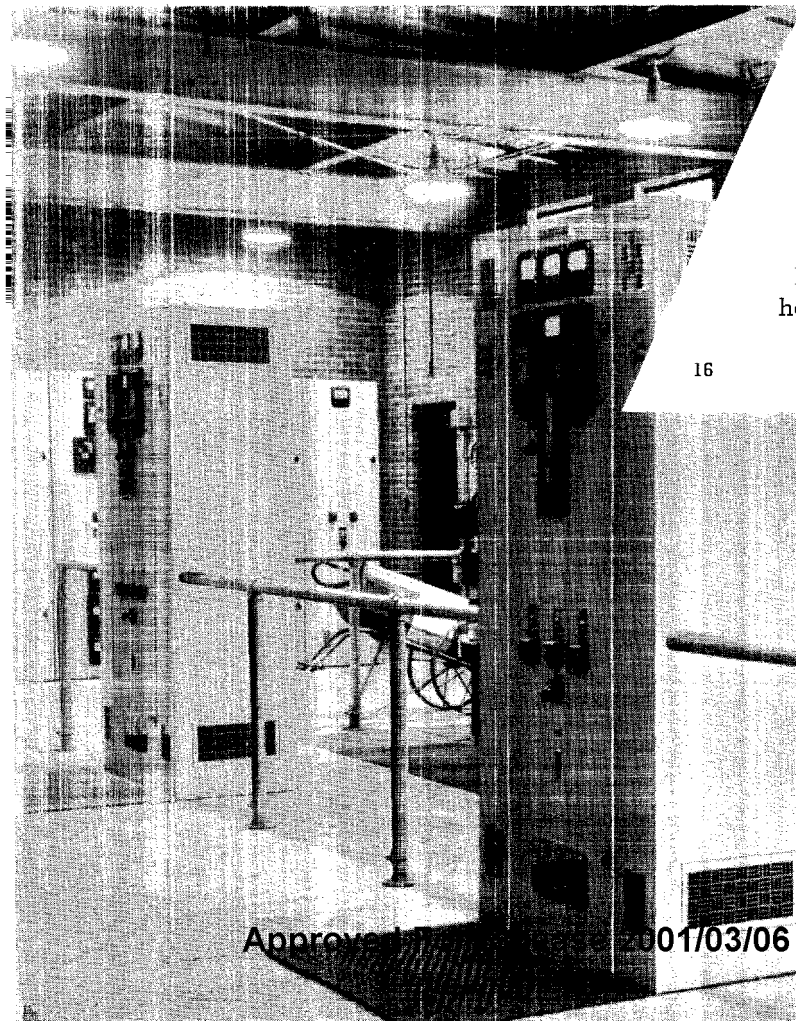

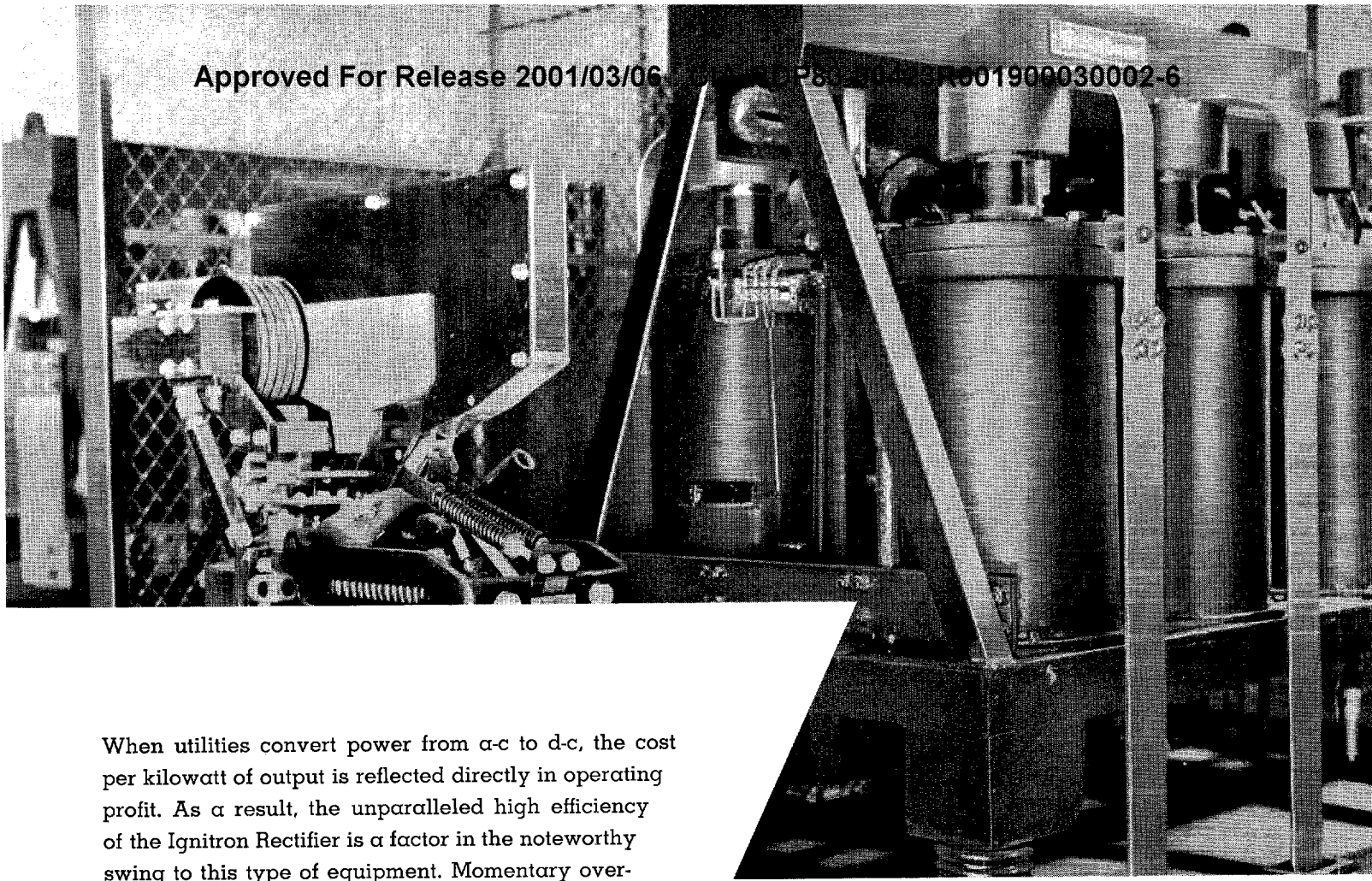

When utilities convert power from a-c to d-c, the cost per kilowatt of output is reflected directly in operating profit. As a result, the unparalleled high efficiency of the Ignitron Rectifier is a factor in the noteworthy swing to this type of equipment. Momentary overloads and short circuits won't damage the Westinghouse Ignitron Rectifier. Voltage can be controlled easily and economically.

The Ignitron Rectifier is an ideal conversion device for supplying direct current for powerhouse auxiliaries. It also has definite advantages for office building loads supplied from a d-c network.

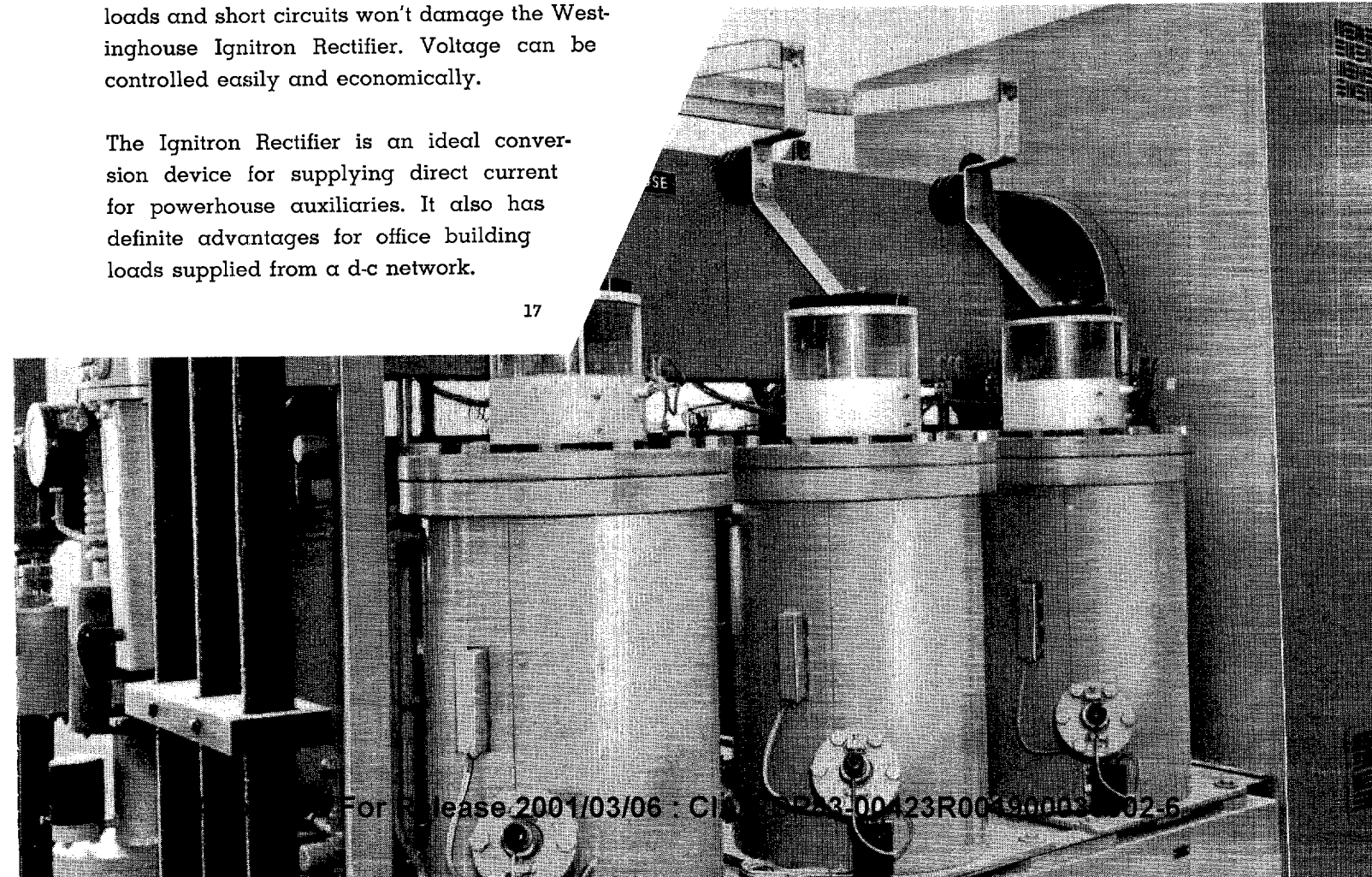



# Principle OF THE IGNITRON RECTIFIER

The phenomenon on which the mercury arc rectifier is based is the fact that in an ionized gas at low pressures, only a small positive potential with respect to the gas is required to cause current to flow to an electrode, while a large negative potential can be applied before appreciable current flows. The cathode, or negative terminal, must supply electrons. With a cathode spot on the negative electrode, in the presence of a gas an anode will pick up current when a positive potential is applied. Without a cathode spot, the negative electrode will not supply electrons and no current will flow.

Since a cathode spot cannot be created reliably in a low-pressure gas by the application of high voltage, it is necessary to start a rectifier by some other means. In the multi-anode tank rectifier, the arc is established by separating electrodes having an applied potential at the cathode surface. The cathode spot thus formed is maintained continuously by a small current to an auxiliary anode. This arc current maintains sufficient ionization for reliable pickup of the main anodes. The continuous presence of ionized gas, which includes the time that the anodes are bearing reverse voltage, greatly

facilitates the formation of a cathode spot on an anode, which materializes in a short circuit in the reverse direction, as an arc-back.

The Ignitron principle provides a method of starting an arc reliably in a few microseconds. This method of starting an arc is based on the fact that when current is passed between a high resistance and low resistance material in contact, a gradient may be set up at the junction sufficient to create a cathode spot. This method is amenable to synchronous application. With such a system of ignition, the arc may be permitted to extinguish at the end of each conducting period. This leaves the anode surrounded by a de-ionized gas during the time that it is bearing a reverse voltage. Of course, in order to take advantage of this method of operation, each anode with its own cathode is mounted in a separate chamber, thus removing it from the influence of other anodes when they are conducting current. This permits a reduction of the shields and grids to the minimum necessary to take care of the transition periods and permits the location of the anode close to the cathode with a consequently low arc-drop.

FIG. 1--Typical efficiency curve for an Ignitron Rectifier unit.

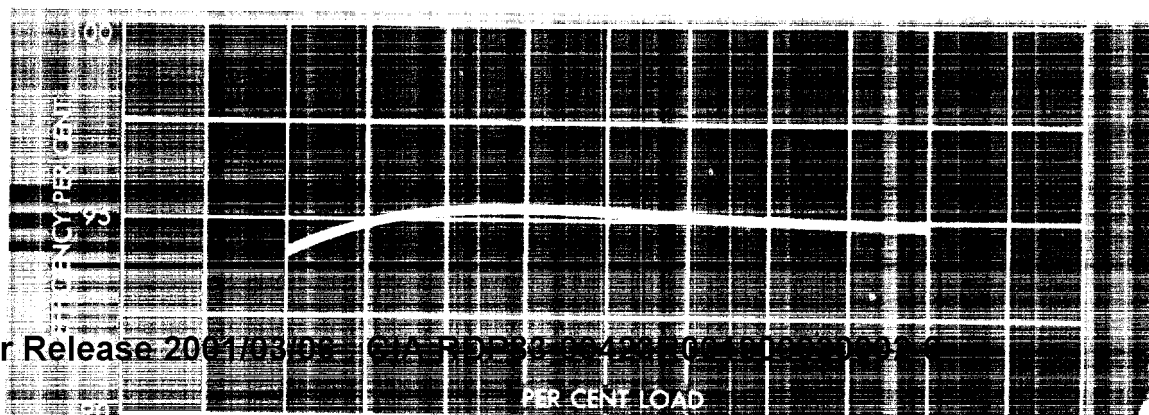



## Mercury Vapor Forms Path for Current Flow

The phenomenon of rectification does not depend on materials of either the gas or the electrode. Mercury, however, is peculiarly suitable for the negative terminal (cathode) at which the heat of the arc concentrates on a small spot. Mercury is a metal which is liquid at ordinary temperatures, and is vapor at temperatures which are readily attained and maintained, has the right density and other characteristics for both the required conductivity and insulation strength. The vaporized mercury provides the path for the flow of current.

This vaporized material is not permanently removed from the cathode surface (ultimately destroying its usefulness) but condenses and flows back to the cathode as a liquid. Mercury vapor is a gas in which the collision of electrons with molecules is highly elastic, and so conducts current with inherently low loss. The anode or positive electrode is graphite. Graphite withstands the temperatures of operation better than other available materials, and because it does not melt but vaporizes directly, it withstands "arc-backs" with negligible injury.

Rectifiers must be substantially free from gases other than mercury vapor. In the common gases, collisions with electrons are not elastic, power loss is higher and the breakdown strength is less reliable. Certain of the gases, notably oxygen, combine with mercury under conditions of high temperature and form compounds which would interfere with the operation of the rectifier and in time destroy the mercury cathode.

An Ignitron Rectifier consists of a gas-tight steel container in which there is the anode of graphite and cathode of mercury. An ignitor is used to initiate the cathode spot at each cycle. The ignitor is a high-resistance rod, partly immersed in mercury, through which a current of sufficient magnitude flows to the mercury. The potential gradient set up at the junction between the two materials is sufficient to initiate a cathode spot. The magnitude of the current necessary is dependent upon the resistivity of the material used for the rod.

Once the cathode spot is started, the anode will pick up current if it is positive with respect to the cathode. The arc will be extinguished as the anode becomes negative, and will not carry current until the next positive half cycle, when the cathode spot is re-established by the next synchronously timed impulse.

FIG. 2--Typical arc-drop curves of 1,500-kw, 600-volt d-c rectifier units.

## How the Ignitron Principle Reduces "Arc-Back"

It has been found that occasionally a cathode spot will spontaneously appear on an anode when it is bearing reverse voltage and when it should be maintaining its high resistance to reverse current. When this happens, a reverse current will flow. This phenomenon is known as "arc-back." Once formed, a cathode spot on the anode will maintain itself as long as current is conducted to it and the rupturing of this current requires the opening of protective circuit breakers.

In the multi-anode tank rectifier in which the arc is maintained in the chamber continuously, it is necessary to use grids, shields and baffles to guard against arc-back. Considerable separation of the anode and cathode is required for this, as well as for mechanical reasons. The shields, grids and electrode separation increase arc-drop, the amount of increase being proportional to the extent to which arc-back is minimized. The elimination of the source of ionization in the Ignitron during the period in which the anode must withstand high reverse voltage removes the major condition which is favorable to arc-back. Elimination of the chief cause of arc-back makes it possible to reduce the anode-cathode spacing and the amount of shielding and gridding. This is done in the Ignitron with substantial decrease in arc-drop with a consequent gain in efficiency. Reduction in arc voltage of the Ignitron from that of the multi-anode tank rectifier is illustrated in Fig. 2. The arc-drop is materially less over the entire load range.

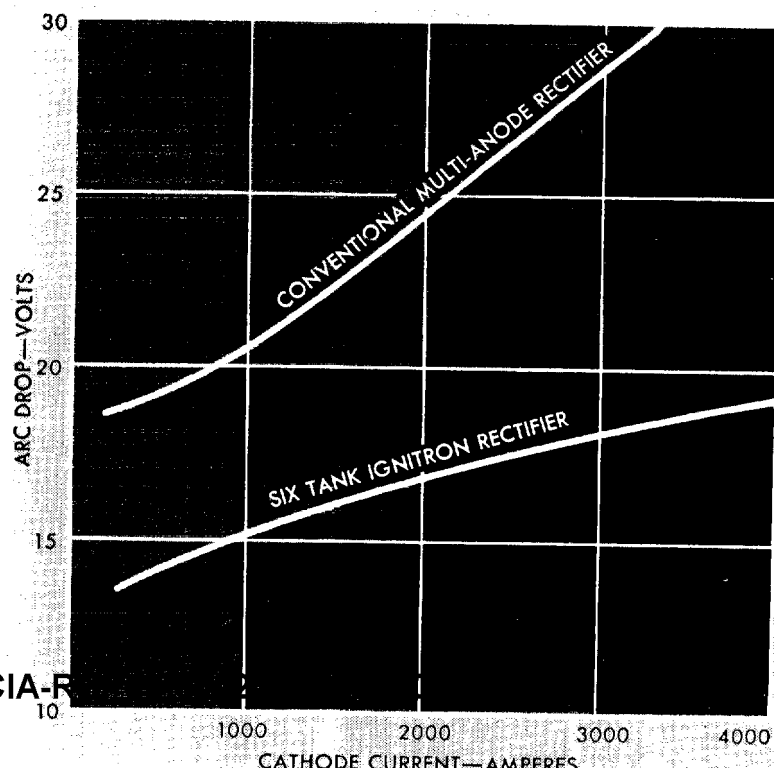

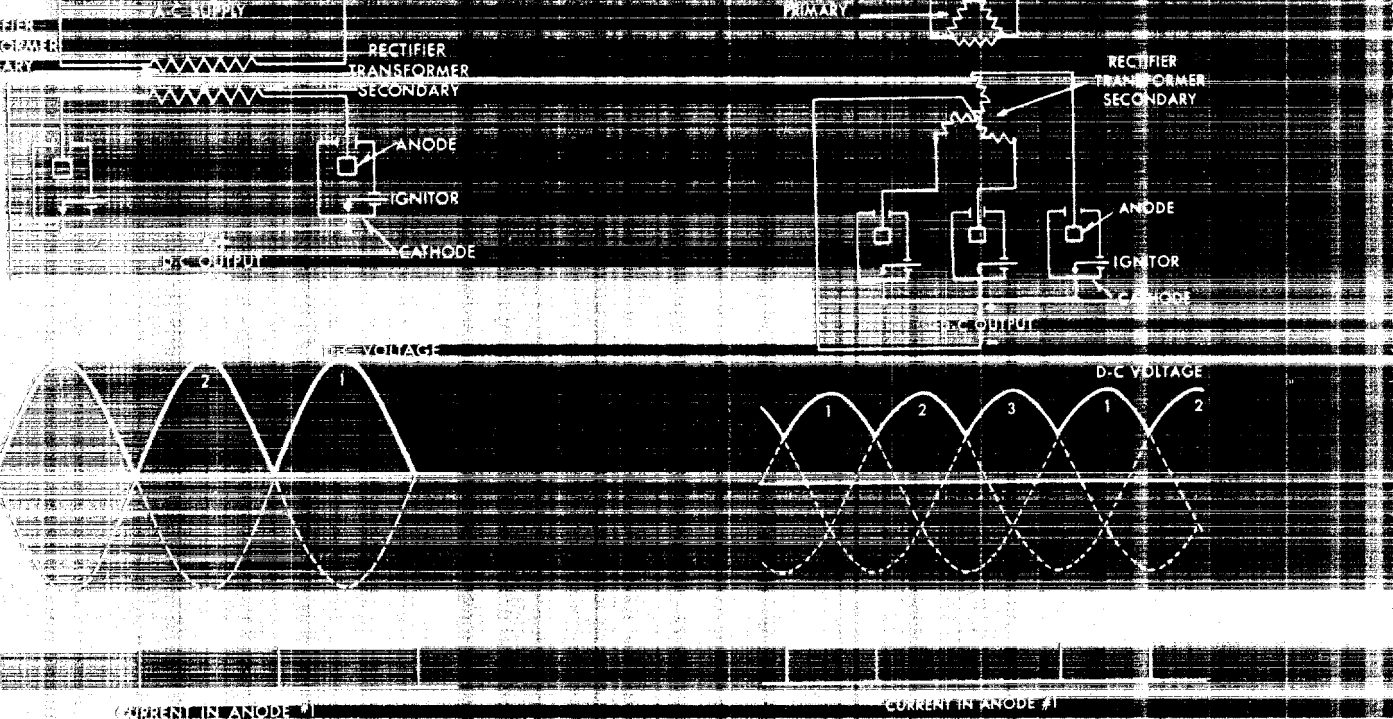

FIG. 3—Wiring diagram of single-phase, full-wave rectifier.

FIG. 4—Wiring diagram of Delta three-phase zig-zag rectifier.

# RECTIFIER CIRCUITS

One of the simplest forms of a full-wave rectifier is shown in Fig. 3. It consists of a single-phase transformer with a valve element in each leg of the secondary. The return circuit is connected to the mid-point of the transformer secondary. Each of the two valve elements passes current as it becomes positive, and the result is a pulsating current. As the number of phases is increased, the voltage output becomes smoother, but the time each phase is active is reduced. The effect of increasing the number of phases will be seen by comparing Figures 3, 4 and 5. Obviously, use of more phases decreases the utilization of the anodes and the windings.

The three-phase connection is a desirable compromise between utilization of the phases and wave form. By special connections of transformers, a larger number of anodes may be

made to operate in groups of three, as shown in Fig. 6, giving the utilization of three phases and the wave form of a greater number of phases. The RMS current in the windings of the two three-phase d-c windings is only 70.7 per cent of that obtained in the six-phase transformer.

## Excitation Circuit — Accurate and Reliable Ignition

The Ignitron circuit is designed to give a pulse of current once each cycle through the ignitor rod to the cathode. One form of excitation circuit is shown in Fig. 7. The impulsing transformer is phased out with respect to the rectifier transformer so that the excitation impulses have the correct phase relationship with respect to the voltage applied to the Ignitron anodes. As

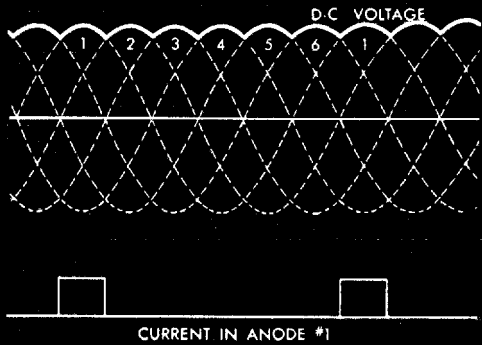
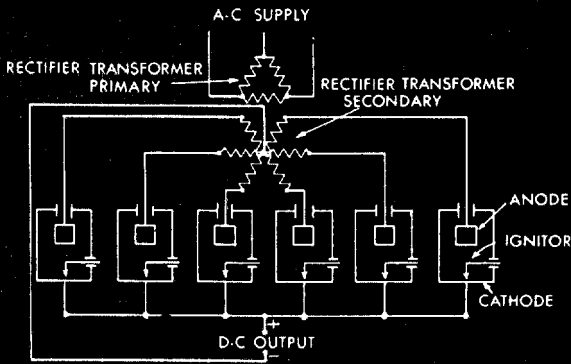

FIG. 5—Wiring diagram of Delta six-phase star rectifier.

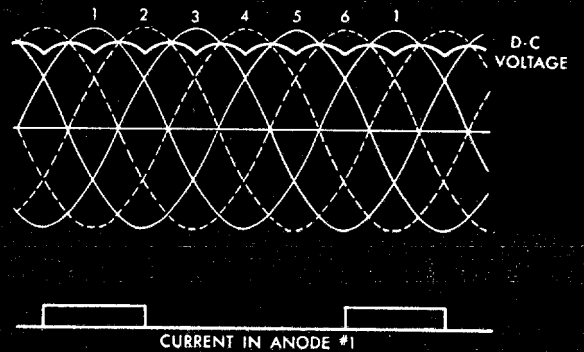
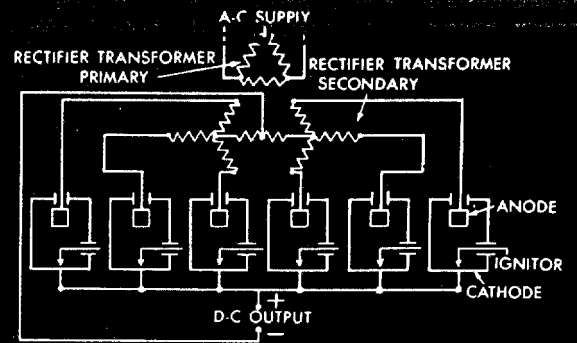

FIG. 6—Wiring diagram of Delta six-phase double wye rectifier.

voltage from impulsing transformer becomes positive on its sine wave, current passes through the linear reactor and charges the condenser.

The reactor governs the charging rate of the condenser. The same voltage is impressed across the Hipernik® core, saturable reactor, pair of rectoxes and ignitor in series. Hipernik iron has a saturation curve which is a straight line until saturation is reached, at which point there is a sharp knee and beyond which there is practically no increase in flux through the iron. When saturation is reached, further increases

in voltage will not increase the flux and the reactance of the reactor becomes very low. This permits the capacitor to discharge through the reactor, rectoxes and ignitor in series. The flow of current from ignitor to the cathode creates the cathode spot.

The impulses through the ignitors have a sharp rate of rise which insures accurate and reliable ignition. Correct timing and energy of the impulse is obtained by correct design of the entire circuit. Direction of current flow is controlled by the rectoxes.

FIG. 7—Wiring diagram of Ignitron ignition circuit.

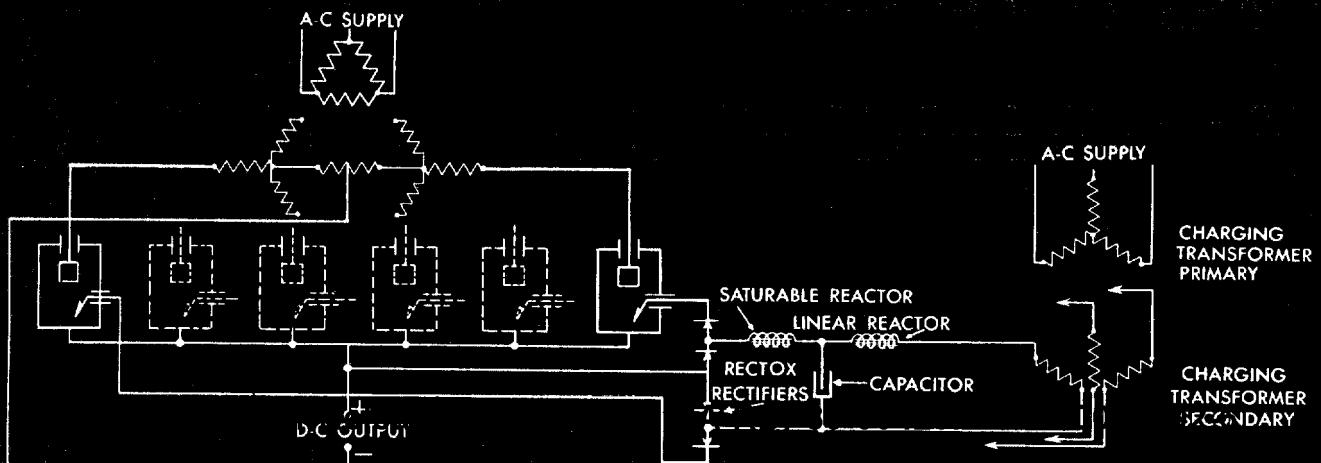



# *Construction*

## **Construction Quality Determines Performance Quality**

The quality of performance given by a rectifier is determined by the quality of construction. By close study of, and adherence to the fundamental principles of the mercury arc, together with the greatest possible refinement in manufacturing details, the Westinghouse Ignitron Rectifier has been brought to a quality that is unparalleled.

Careful attention has been given in the design so that parts and surfaces are arranged to provide the necessary de-ionization and gradients with the least obstruction to the arc, and also so that the mercury vapor flows from its source at the cathode to the condensing surfaces with the least possible turbulence, thus maintaining the vapor pressure necessary for best operation.

The successful achievement of this objective is responsible for the high efficiency and freedom from arc-back in the Ignitron, repeated arc-back having been the major barrier to application of mercury arc rectifiers for nearly thirty years after the original invention. Random arc-backs

have been brought to a negligible number in the Ignitron (Fig. 8).

### **Vacuum-Tight Welded Steel Ignitron Tanks**

Each Ignitron tube or tank is made of specially selected steel plates, welded vacuum-tight. All seams are welded on the inside so that no cracks are exposed where foreign materials might lodge. Since any extraneous materials within an Ignitron tube may contribute to the condition which causes an arc-back, the inside of each tube must be kept free of foreign materials, both those which might be left in the tank when assembling, and by gases that might leak in during operation.

The design and construction make interior parts accessible and any one of the Ignitron tubes of an assembled unit may be serviced without disturbing the rest of the unit. This is another factor that contributes to low maintenance cost.

# OF THE IGNITRON RECTIFIER

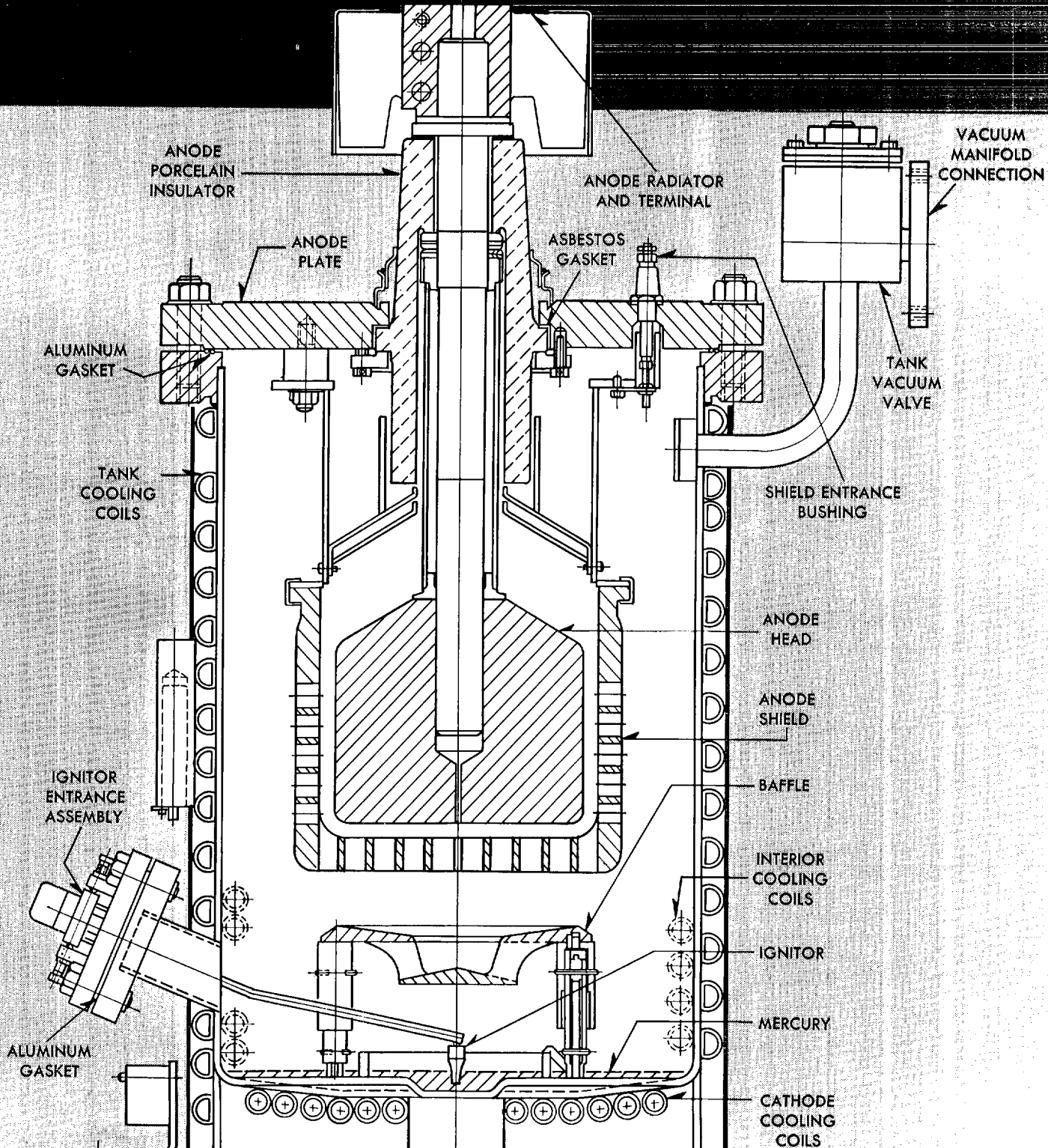

Approved For Release 2001/03/06 : CIA-RDP83-00423R001200030002-6

FIG. 8—Cross section of the Ignitron showing construction.



Enameled aluminum rings are set in a groove of slightly smaller diameter and compressed to form an absolutely tight seal at cover plate and ignitor entrance.

# SEALS

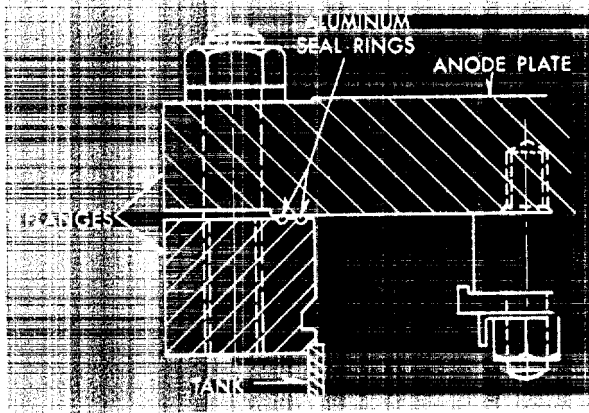
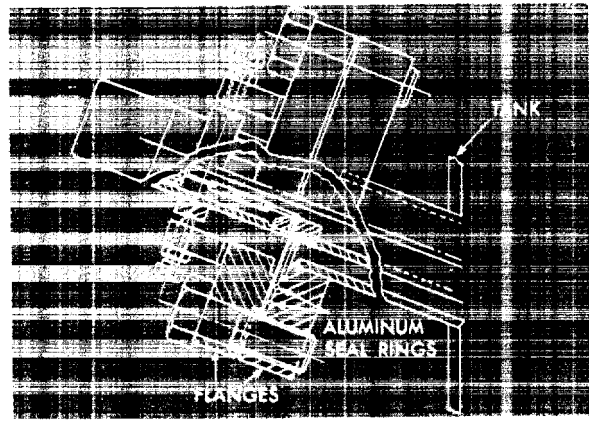

FIG. 9 Cross section showing metal-to-metal seal.

Seals used by Westinghouse are exclusively of solid materials, the use of sealing fluids being avoided completely. The cover plate and ignitor entrance seals consist of enameled aluminum rings set in a groove of slightly smaller cross-section diameter and compressed as shown (Fig. 9). Use of two concentric rings makes an absolutely tight joint. The enamel is of a special composition which protects the aluminum ring from the mercury vapor.

Anode leads are taken into the vacuum chamber through porcelain bushings, soldered vacuum-tight to the tank with the exclusive Westinghouse solder-to-porcelain process. Although this makes a permanently tight seal, it can be replaced in the field in event of accidental damage to an anode. Separable joints in the vacuum pumping system which operate at low temperatures are gasketed with a special grade of rubber which is substantially free from gas

FIG. 11—Cross section of ignitor entrance assembly.



Exclusive Westinghouse solder-to-porcelain seal is applied to porcelain bushings.

FIG. 10 Vacuum-tight anode bushing.

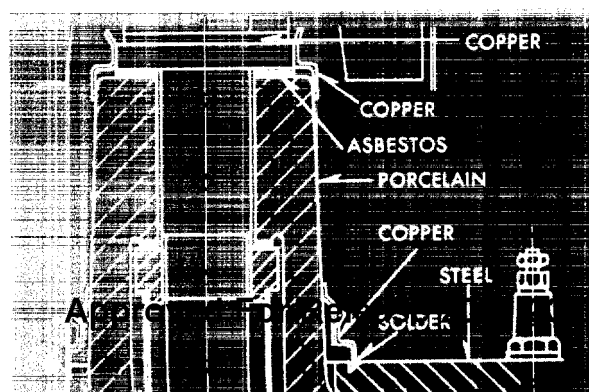



evolution. The rubber is protected from the mercury vapor by steel vee-rings which also constitute a complete retainer for the gasket.

The entrance bushing for the ignitor utilizes a Kovar-hard glass seal as the vacuum-tight insulator. The entrance bushing for the shield potential is a special aviation type mica insulated spark plug which screws into the cover plate and which is made vacuum-tight by a copper gasket.

## Anode Assembly

The design of the anode assembly is simple and rugged. Electrodes are of highest quality graphite. Anodes operate at high temperatures and the anode shank design must provide temperature gradients such that the insulating and terminal parts operate at permissible temperatures. In the Westinghouse design, these temperatures are maintained by the correct choice of materials in the anode stem, and with the aid of a small copper radiator. Use of a water-filled radiator is avoided. Insulating porcelain is so located that it operates well within safe temperature limits.

The anode and shield assembly is shown in Fig. 8. The shield is made of graphite and is

capable of withstanding the high operating temperatures safely. Shields are suspended on Mycalex insulators.

## Cathode

The mercury of the cathode is contained in the bottom of the tank. Cooling fins in the bottom of the tank (which is covered with external cooling coils) keep the mercury at correct operating temperature. The quartz ring confines the cathode spot to the desirable area and any accumulated dirt is kept outside the ring, away from the active area of the cathode. Construction details are shown in Fig. 8.

## Ignitor

An exclusive Westinghouse development, the ignitor is a pencil-point-shaped rod of high resistivity. It is partly immersed in the mercury cathode as is shown in Fig. 8. The characteristic of the ignitor is such that a small impulse of power initiates a cathode spot. The ignitor assembly includes a flexible diaphragm which permits adjustment from outside the tank.

Photo shows three stages in the construction of Ignitron Rectifier anode assemblies.



Copper coils are soldered to the outside of the vacuum chamber of each Ignitron tank. Cooling water circulates through these coils at high velocities. Cooling systems are made of nonferrous materials throughout.

## Efficient, Corrosion-Resistant Cooling System

It is necessary to provide a cooling system for rectifiers to dissipate the heat of the arc and to control the mercury vapor pressure in the vacuum chamber. For power units, this is most simply accomplished by a water cooling system. Copper coils are soldered to the outside of each vacuum chamber of the Ignitron assembly, and water is circulated through these coils at high velocity by a motor-driven recirculating pump. In the larger sizes there are several turns of cooling coil inside each vacuum chamber near the cathode. Use of nonferrous materials for the cooling system practically eliminates the corrosion problem, and the use of high velocity water circulation adds materially to cooling efficiency. The old-style steel water jackets were subject to corrosion and the relatively large water volumes required necessitated slow water movement with consequent reduction of cooling effectiveness. If good quality water, free from acids, solids and scale-forming mate-



rials, is available, direct cooling can be used. Temperature of the recirculated water is maintained automatically within permissible limits by an automatic valve, thermally operated, by admitting water in proportion to the arc loss.

Water discharged from the cooling system is maintained at approximately 55° C. On this basis, an approximation of water consumption can be arrived at by figuring on 0.3 gallons of water per minute per hundred amperes of rectifier load.

If the quality of the cooling water available is not high, a water-to-water heat exchanger is used. The recirculating water system can be filled with good quality water and the heat dissipated from this to the cooling water through the heat

FIG. 12 Diagram of the Ignitron cooling system.

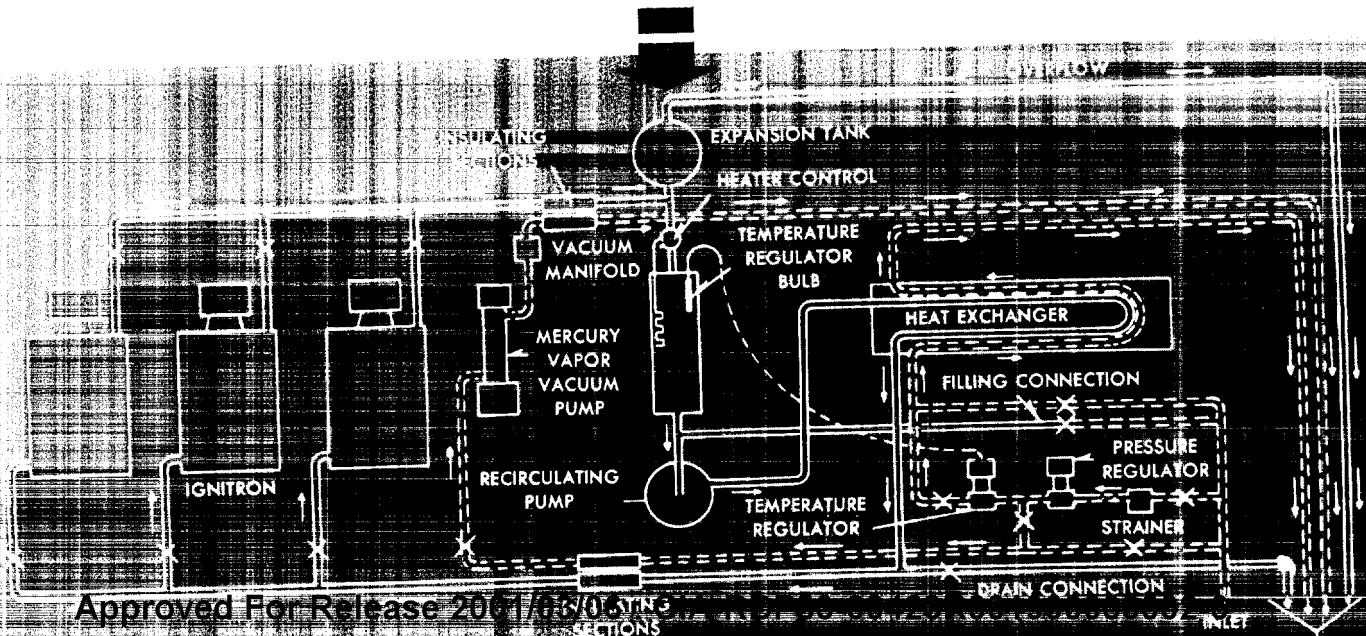

exchanger. With this system, the quantity of water is increased (usually about 25%) depending upon the efficiency of the heat exchanger. (Fig. 12).

If a supply of cooling water is not available, a recirculating system with water-to-air heat exchanger can be used. For this system, correct temperatures are maintained by automatic

thermal control of the motor-driven fan. CAUTION: For some locations and with a closed recirculating cooling system, antifreeze compounds are added to the recirculating water. Some commercially available antifreeze compounds become acid with use, and it is necessary to test the solution periodically for acidity. If acidity is shown, the system must be drained and filled with fresh solution.

## EASE OF INSTALLATION

Ignitron Rectifiers usually are assembled in groups of six or more individual Ignitron tanks or tubes. The assembly is mounted on a self-supporting structural steel base, with bracing and lifting members (see photo, below). The assembly is complete with vacuum system, cooling piping, valves, etc., and all parts within the structure are complete with wiring for control and power connections to terminal blocks.

After installation, the only work involved is connection of the control, power and water circuits to associated equipment. Auxiliary apparatus such as insulating transformers, excitation supply, hot wire gauge supply, vacuum relays and control switches are mounted in an

auxiliary cubicle. The cubicle is completely wired to terminal blocks.

### Installed Anywhere

The Ignitron assembly, control switchboard and heat exchanger (when used) may be installed in any room having a substantial and reasonably level floor. The rectifier and heat exchanger are self-supporting and require only reasonably accurate alignment or leveling. The switchboard may require wall supports or may be built into a self-supporting structure. The transformer may be constructed for indoor or outdoor service, for mounting on the usual type foundation.

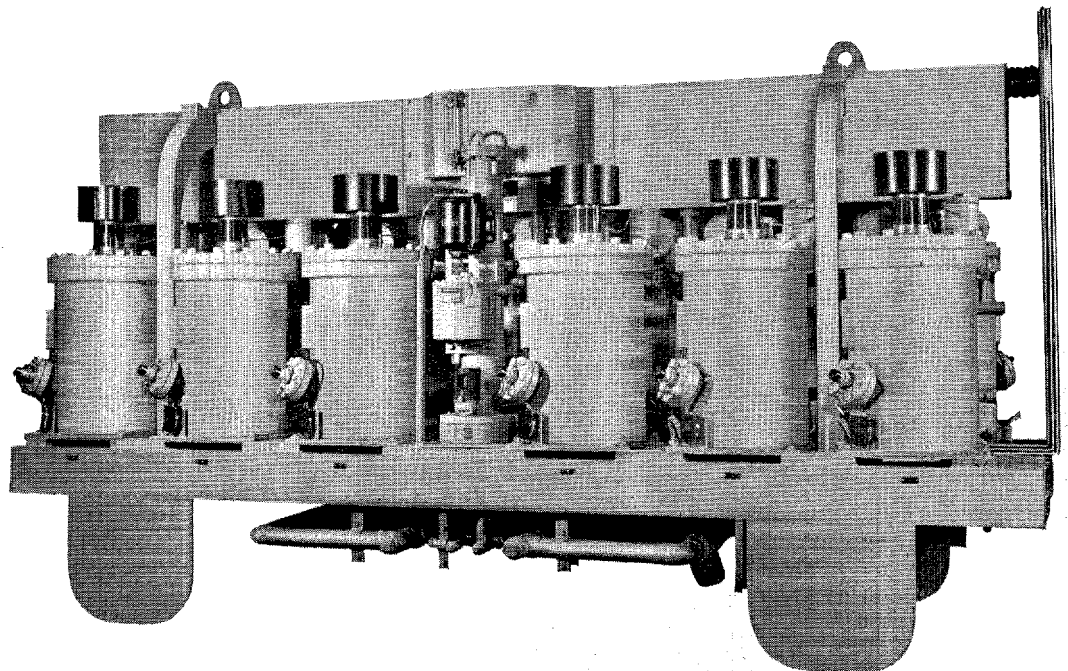

Assembly of twelve Ignitrons, mounted on a structural steel base.



# IGNITRON RECTIFIER

*Continuities*

Vacuum maintaining and indicating apparatus is designed to properly evacuate the Ignitron tubes and to indicate the pressure maintained. This equipment is mounted on and forms an integral part of the assembly. The system is automatic in operation. (Fig. 13).

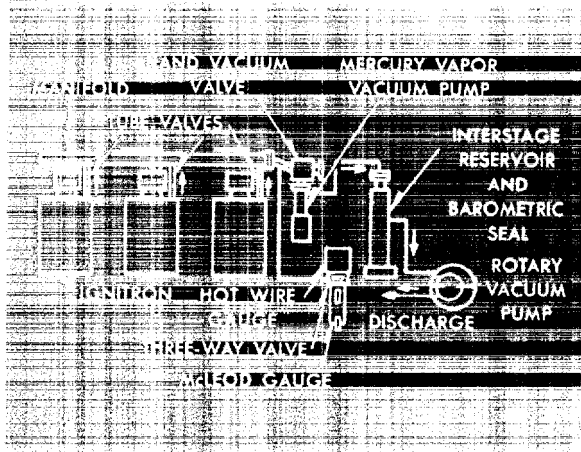

FIG. 13 Schematic diagram of vacuum system.

The tubes of an Ignitron assembly are manifolded and the vacuum is maintained by a continuously operated mercury vapor vacuum pump which pumps gas from the manifolding through the mercury trap and discharges it through a barometric tube into an interstage reservoir. A rotary, oil-sealed backing pump, pumps the gas from the interstage reservoir and discharges it at atmospheric pressure.

Vacuum connections on the high-pressure side of the interstage reservoir are made with flared copper fittings. These fittings are small, fool-proof and make reliably tight joints.

A Pirani-type hot wire gauge connected to the vacuum manifold continuously indicates the pressure in the vacuum system and operates

to shut down the Ignitron at high pressures. A McLeod type gauge, manually operated, is supplied for accurately reading the pressure and calibrating the hot wire gauge. The auxiliaries are described in detail as follows:

## Hand-Operated Vacuum Valve

The vacuum valve for use between the manifold and mercury vapor vacuum pump, is small and compact by virtue of a flexible steel bellows. The steel bellows, welded to the fixed body and moving mechanism, provides a vacuum-tight operating mechanism. Valve seat is of high-quality rubber, making a reliably tight valve with little pressure exerted on the hand-wheel. Movement of the valve disc is large as compared to the opening in the valve body, thereby minimizing pressure drop in this device when pumping gas from the vacuum system. (Fig. 14).

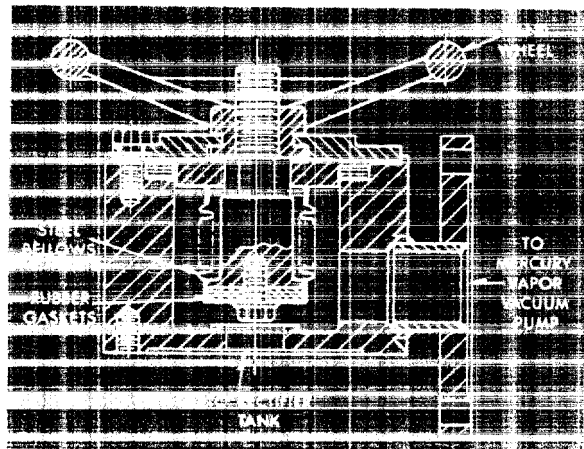

FIG. 14 Hand-operated vacuum valve.

## Mercury Vapor Vacuum Pump

A mercury vapor diffusion pump is capable of evacuating a vessel to a very low pressure, but will not pump against a high back pressure. The pressure to which a vessel can be reduced with this pump is of the order of a fraction of a micron. (One micron is the pressure which will support a column of mercury 0.001 millimeter high. Atmospheric pressure is 760 millimeters, so one micron is, therefore, 1/760,000 of an atmosphere).

The back pressure from a diffusion pump may be stepped up by use of one or more ejector nozzle type stages. The back pressure against which a mercury diffusion pump will exhaust is from 250 to 500 microns. In the three-stage pump, two additional stages of the nozzle type exhaust in series from the discharge of the first, or diffusion stage, to a back pressure of the order of 20 millimeters. (Fig. 15).

In the diffusion stage of a mercury vapor pump, a blast of mercury vapor from a mercury boiler is directed against a cooled surface at an angle in which it is desired that the gas should flow. This vapor is condensed when it strikes the cooled wall, and the liquid mercury flows back to the boiler through a trap. In this way there is no vapor flowing toward the gas inlet of the pump, and any permanent gas molecules which diffuse into the stream of mercury are carried along and prevented from returning. This principle operates only with rarefied gases. Because of the low pressures of the gas, in order to obtain a reasonable speed of pumping the area of this stage is made large to present a large opening into which the low-pressure gas can diffuse. The second and third stages, which deal with higher pressures, are made smaller. The pump is so constructed that mercury vapor is supplied from an electrically heated boiler at the bottom of the pump, and is fed to the several stages in parallel. A common cooling system

consisting of copper cooling coils provides cooling around the stages, and the liquid mercury is returned to the boiler through a series of traps. The gas discharge tube is extended along the edge of the cooling coils up toward the pump intake, in order that any mercury tending to be discharged from the pump is condensed and returned to the boiler.

Design of the interior parts, nozzle spacings and size of parts, make up a small, compact and yet highly efficient pump. This pump, in contrast to other commercial types, can be mounted directly on the Ignitron Rectifier assembly with little increase in its over-all dimensions.

FIG. 15 Three-stage mercury vapor vacuum pump.

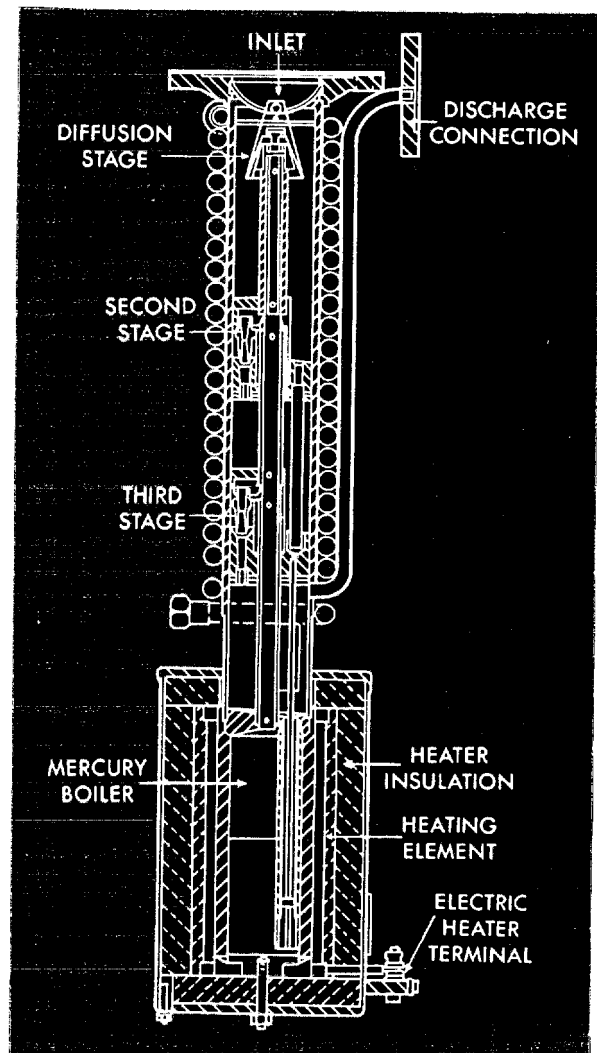

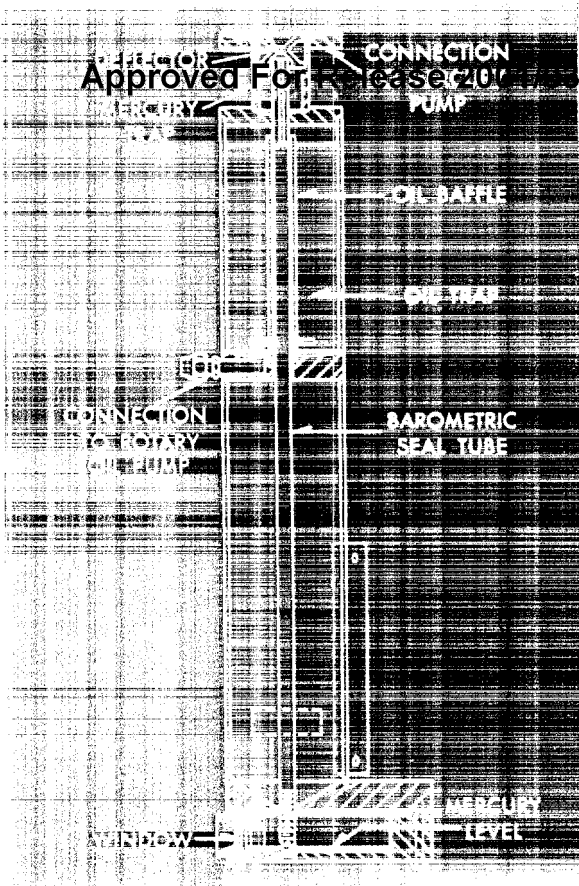

FIG. 16 Interstage reservoir and barometric seal.

## Interstage Reservoir and Barometric Seal

The mercury vapor vacuum pump, pumps from the Ignitrons into the interstage reservoir, from which the gases are pumped to atmosphere by the backing pump.

The barometric seal consists of a tube somewhat longer than barometric height, with its lower end immersed to a few millimeters in a mercury pool. Gas being discharged from the mercury vapor vacuum pump flows through the tube and bubbles through the head of mercury into the reservoir. (Fig. 16). The mercury pool is large in diameter so that if atmospheric pressure reaches the interstage reservoir, mercury will be forced up the tube to barometric height without exposing the end of the tube, thereby forming an inherently automatic vacuum seal to the vacuum manifold. An oil trap in the upper portion of the reservoir prevents oil from the backing pump from coming in contact with the mercury in the pool in the event of voltage failure to the backing pump driving motor.

A manometer type pressure gauge which shows the pressure in the interstage reservoir is supplied. This indication of the performance of the backing pump is useful for tests of the vacuum system and during maintenance work.

## Rotary Oil-Sealed Vacuum Pump

A direct-connected, slow-speed, three-phase motor and pump operate continuously to exhaust the gas from the interstage reservoir. Pumping action is obtained in this unit by the rotation of a rotor that is eccentric to the pump frame. Two radially movable blades force the gas from the pump intake to the discharge. Oil in the pump seals the blades, the rotor and frame, making the compartments formed between intake and discharge vacuum-tight when the pump is operating.

The Westinghouse rotary vacuum pump will pump down to a pressure of less than one millimeter of mercury with an average pumping speed of about 0.3 liters per second. A direct-connected vertical pump eliminates the necessity for stuffing boxes and eliminates oil leakage from the oil reservoir mounted around the pump proper. The close manufacturing tolerances, the absence of gears and the smallness of parts combine to make a quiet-operating unit. (Fig. 17).

FIG. 17 Rotary, oil-sealed vacuum pump.

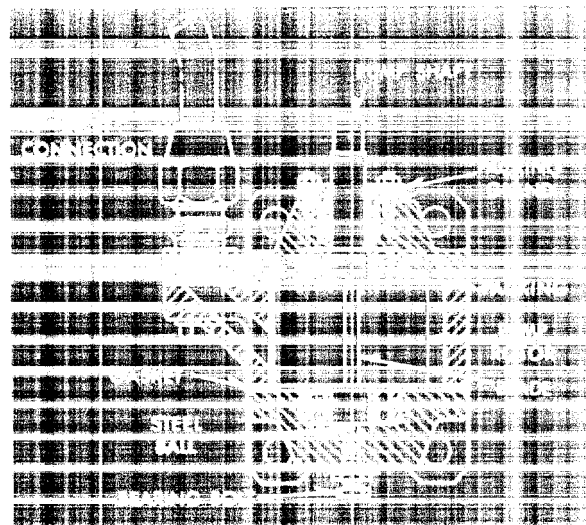

## McLeod Vacuum Gauge

In high vacuum (low-pressure) practice where pressures of the order of one micron are encountered, a special form of gauge is required because the eye cannot detect directly such small differences in balanced mercury column heights. The McLeod gauge gives an accurate reading of low pressures by taking a sample of the gas and compressing it to a degree where it will support a head of mercury to a readable value. (Fig. 18)



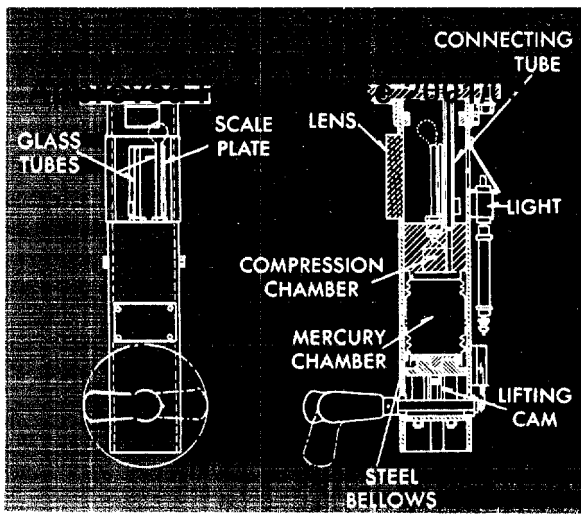

FIG. 18 - McLeod vacuum gauge.

By the use of a flexible steel bellows, the height of this gauge is reduced to practically one third the height of other commercial gauges. The steel bellows assembly is completely welded, thus eliminating any leaks that would affect the accuracy of the gauge. Once this gauge is completely degassed, it remains so since no materials are used in the vacuum chamber which continue to give off gases for long periods of time. A miniature light to facilitate taking readings is mounted back of the translucent scale plate. This gauge will read pressures varying from 0 to 500 microns, the logarithmic scale making the lower values more accurate.

## Hot Wire Vacuum Gauge

The Pirani-type, or hot wire, vacuum gauge is used to continuously indicate the pressure in the Ignitron unit and prevent its operation at excessive pressures. This gauge operates on the pressure-thermal conductivity principle which, with Wheatstone Bridge to detect changes in the resistance of the hot wire filament, indicates pressure. One filament in a glass tube exposed to the pressure in the Ignitron vacuum manifold forms one leg of the bridge, a compensating bulb completely evacuated and sealed off forms another leg, and two variable resistors complete the bridge circuit. The presence of gas in the unsealed tube affects the rate at which heat is lost by the filament. This, in turn, changes the filament resistance and the bridge balance. The indicating and contact-making instruments, calibrated in microns, indicate the pressure and operate to remove the unit from service on high pressure. (Fig. 19).

This gauge is affected not only by a permanent gas, but also by mercury vapor, although less affected in the ratio of the molecular weights of mercury and air. The gauge is located on the vacuum system so that practically all vapors condense before reaching the bulb there-

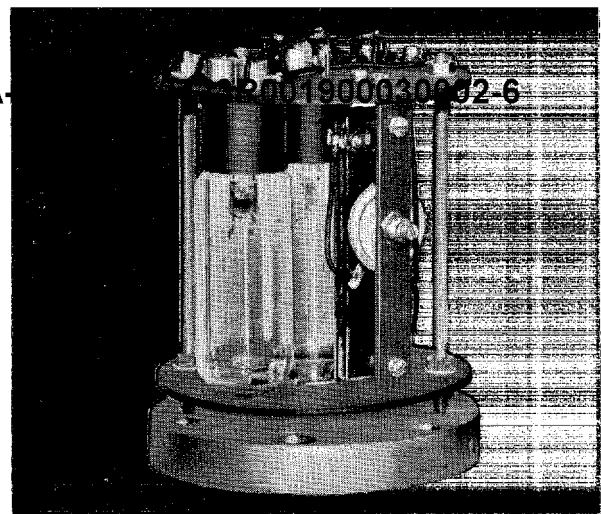

FIG. 19 - Hot wire vacuum gauge, with cover removed.

by giving indication principally of permanent gases.

The hot wire gauge bridge, complete with both bulbs and resistors, is arranged in a small, compact unit. Usually it is mounted directly above the McLeod gauge so that during calibration there is no difference in pressure due to different locations of the gauges in the vacuum system.

## Three-Way Vacuum Gauge Valve

The three-way bellows valve is designed to make connection between the vacuum manifold, the Pirani gauge and the McLeod gauge. It is a low-capacity, low-pressure valve that can be used where it is necessary to maintain a nearly perfect vacuum. The vacuum-tight movable element is obtained by the use of a steel bellows, welded to the compression ring and valve stem, as is shown in Fig. 20. The vacuum seal in the valve assembly is made by compressing the rubber gasket between the compression ring and the valve body.

FIG. 20 Cross-sectional view of three-way type vacuum valve.

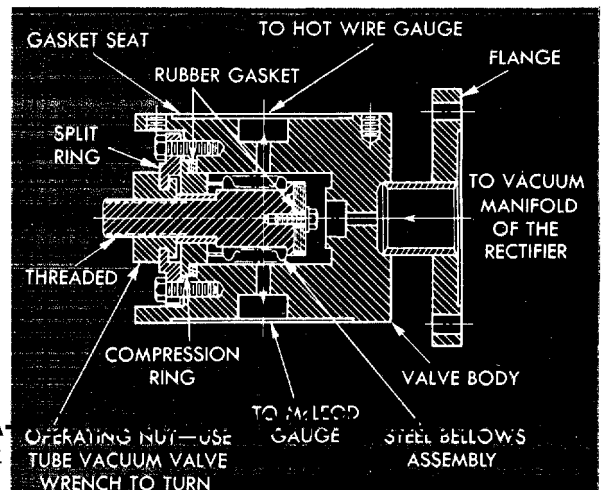

## Surge Suppressors

Voltage surges tend to occur in applications where suddenly applied loads may be encountered with low water temperatures. Voltage surge elimination is accomplished by connecting a capacitor of adequate size in series with a resistor from each anode to cathode, to damp out any oscillations. Since surges are due to instability in the arc under abnormal conditions, their elimination is best accomplished by provisions at the source.

## Degassing Equipment

After an Ignitron Rectifier is assembled, it must be subjected to a degassing process in order to remove all of the foreign gases before it is suitable for operation at its rated voltage. This consists of evacuating the rectifier and applying current somewhat above its rating, but at low

voltage, to raise the temperature of all parts to somewhat higher than normal temperatures and drive off the absorbed gases. If an Ignitron in service is opened to atmosphere for any reason, it must be re-degassed before being replaced in operation. However, after a rectifier has once been thoroughly degassed, the re-degassing is a relatively short process, unless the interiors of the tubes have been exposed to atmosphere for a long time.

For the purpose of degassing, transformer low-voltage degassing taps can be provided with terminals brought to a terminal board within the transformer. In many cases where there are a large number of rectifiers on a system, or where partial capacity operation is contemplated while degassing one section, it proves more convenient to provide a separate degassing transformer.

In either case, the degassing current is regulated by ignitor control of the direct-current voltage.

32

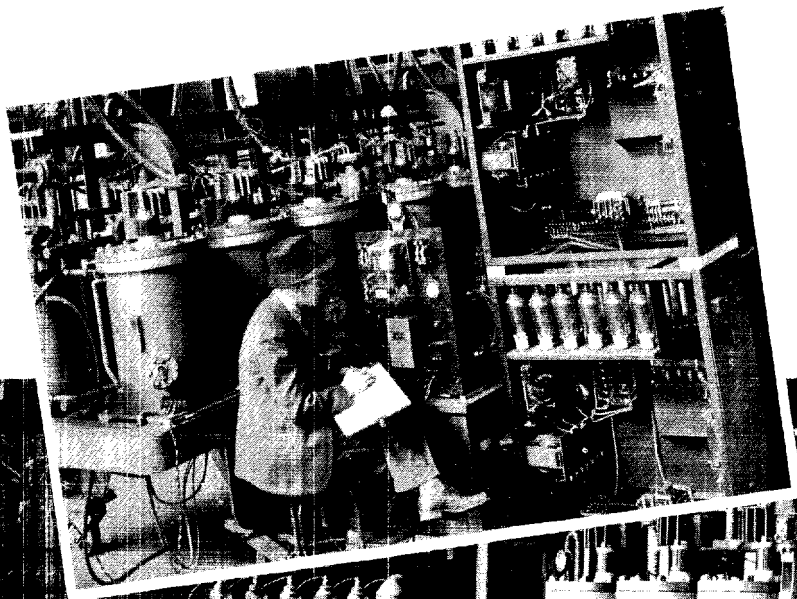

Visible gauges permit careful checking of the degassing operation.

Testing an Ignitron Rectifier.

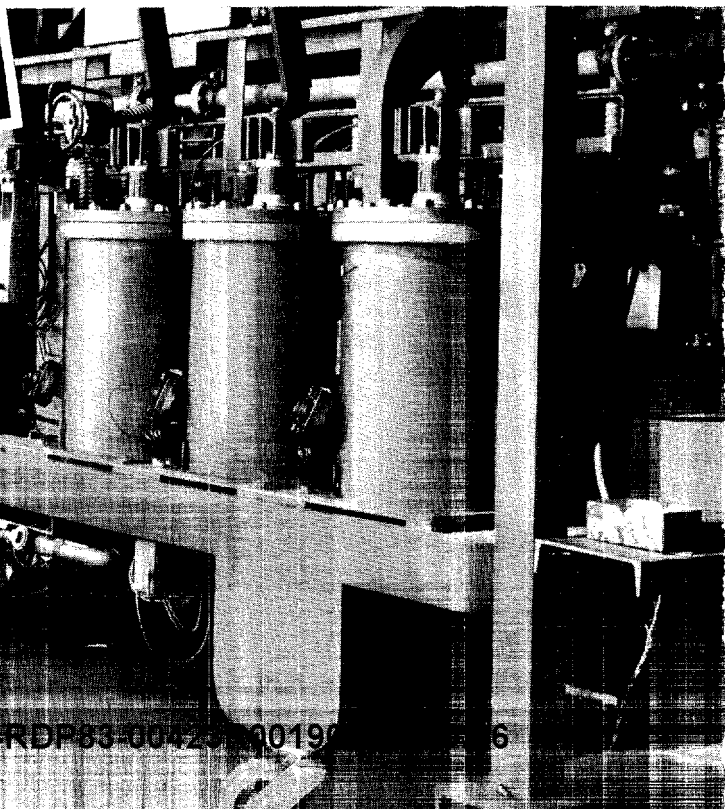

# IGNITRON RECTIFIER POWER SUPPLY TRANSFORMERS

Conditions under which Ignitron Rectifier transformers operate differ in one essential respect from those for rotating machines, in that the d-c windings carry practically no current during certain portions of the voltage cycle. The duration of the conducting and nonconducting periods is determined by the cyclic polarities of the transformer windings, and by the valve action of the rectifier anodes. This mode of operation results in higher transformer losses and increases d-c kva rating required for a given kilowatt output from the rectifier. It also

results in the a-c and d-c windings being of unequal capacity. As a consequence, rectifier transformers are fundamentally more costly than ordinary transformers based on the same kva input rating.

Various transformer windings and connections, which subject the anodes to various current intensities during the conducting cycle, are possible. In general, the types of windings which subject the anodes to lesser current intensities result in more economical transformer designs.

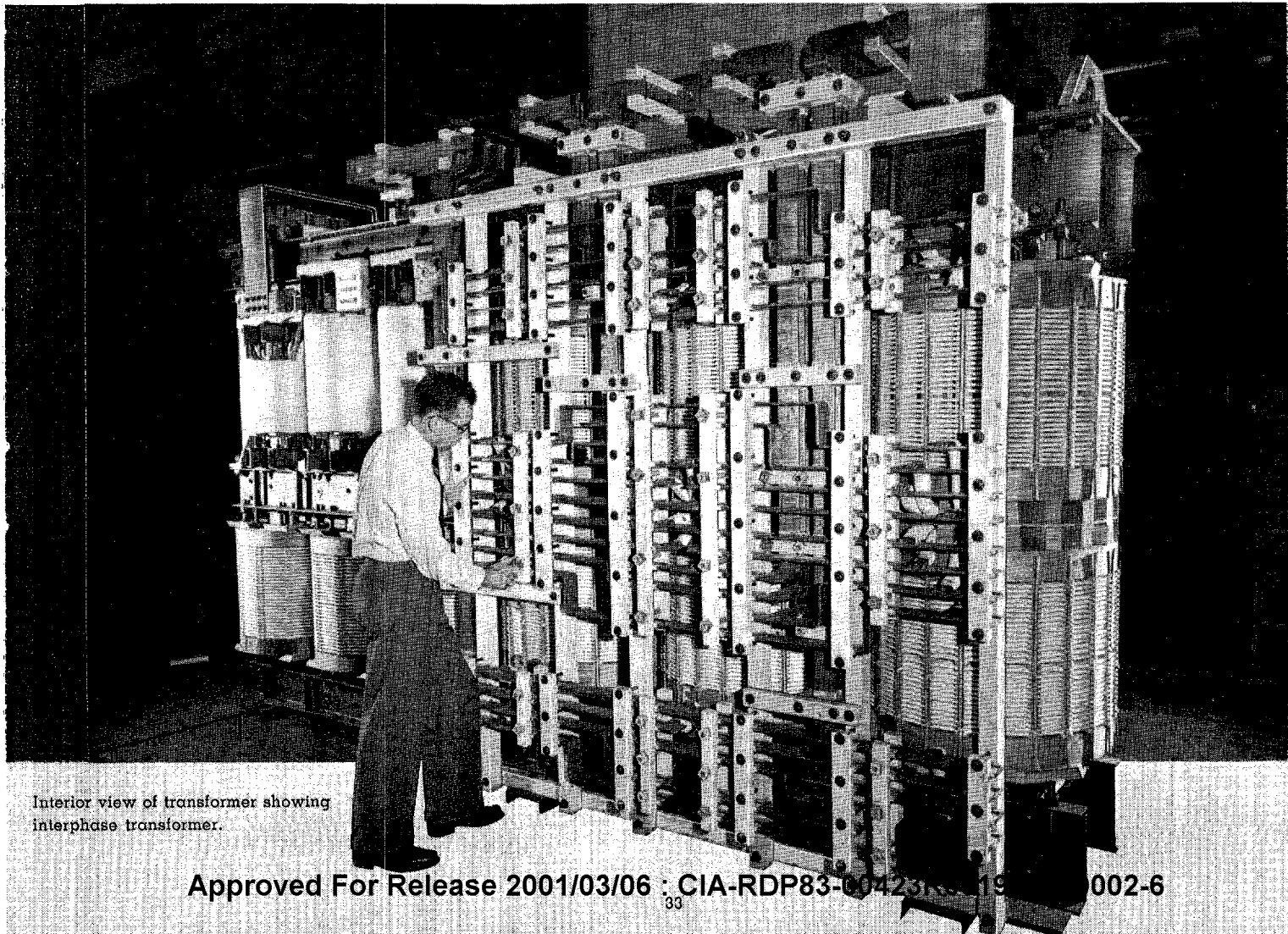

Interior view of transformer showing interphase transformer.



## Interphase Transformers

Westinghouse transformers utilize interphase transformers between wye or zigzag groups of d-c windings which cause the groups to operate as independent, three-phase units. The interphase transformers displace the neutrals of the groups in voltage relation so that essentially six to twelve-phase operation of the Ignitron is obtained, but with the inherent advantages of three-phase operation in which each winding carries current for 120 electrical degrees.

This type of connection may be characterized as superior in the following important respects:

- 1. Simplicity.
- 2. High utility factor on basis of ratio of d-c winding kva to kw.
- 3. Causes Ignitron anodes to operate under most favorable conditions.
- 4. Increased capacity of Ignitron to handle extreme overloads.

Use of the interphase transformer, which provides the benefit of three-phase operation of transformer secondary windings and rectifier-anodes, inherently introduces the disadvantage that at very low currents (below the value required to magnetize the core of the interphase transformer) operation reverts to six-phase and there is a sharp voltage rise which amounts to a theoretical value of approximately 15 per cent. Special provisions have been made in the design of Westinghouse interphase transformers so that this voltage rise takes place at an extremely small load, approximately six-tenths of one per cent of the unit rating.

In most cases this is satisfactory. Where there is a great amount of zero load operation and where voltage rise is a serious disadvantage, means can be provided for separate excitation of the interphase transformer iron, or a phantom load provided to completely eliminate this no-load voltage rise. (Fig. 21).

FIG. 21 --Voltage rise at light load when using interphase transformers.

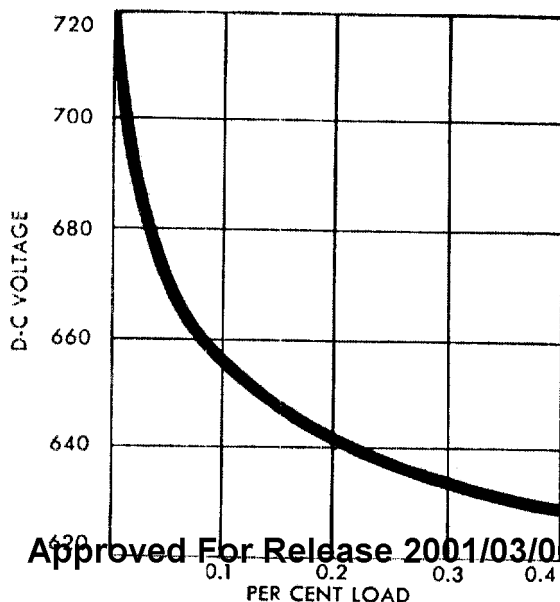

When a rectifier is operated with the voltage reduced by ignition delay, the duty on the transformer and interphase transformer is increased, and this type of operation must be given consideration in the design. Particularly, the size of the interphase transformer must be increased if the intended load involves operation at large angles of delay.

Transformer equipment has been designed to provide uniform impedances in the three-phase groups, and they are so arranged that the load divides evenly between them, and consequently divides evenly between the Ignitron anodes. Accurate balance is important in rectifier transformers to avoid unbalanced currents and distorted wave form. Westinghouse transformers are not only accurately balanced but are also rigidly braced to withstand short circuits on the rectifier and the more severe stresses of the unbalanced short circuits due to arc-back, without damage. The main and interphase transformers can be mounted in the same or separate tanks, whichever is most convenient for the station.

## Direct-Current Voltage Regulation

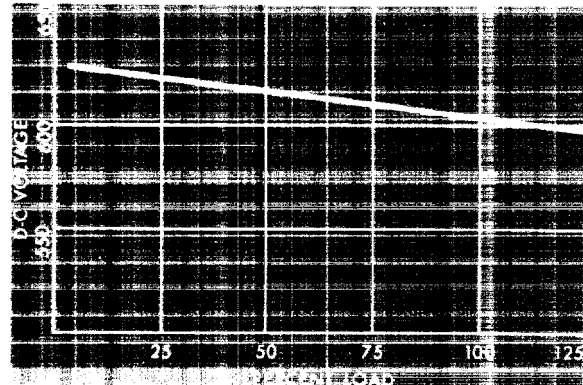

FIG. 22 Direct-current voltage characteristic.

The direct-current voltage characteristic of an Ignitron Rectifier unit is determined almost wholly by the transformer. Arc-drop or voltage loss in the rectifier is essentially constant throughout the normal load range. The decrease in direct-current voltage as the load is increased is caused principally by the increase in resistance and the reactance drop in the transformer windings. With a transformer of normal design, the resultant regulation is of the order of 5 or 6 per cent. In a majority of applications this is the type of regulation that is needed. (Fig. 22). This normal characteristic can be altered, however, by use of ignition control, where desirable.

Ignition control is accomplished by delaying the ignition impulses to the ignitors. The transformer must be designed to provide the highest

voltage desired, and d-c output is reduced from that value by delaying the point of pickup by shifting the phase position of the excitation supply. This delay can be accomplished manually or automatically (with a conventional voltage regulator) as indicated by the application. Inherent compensation or modification of normal regulation can be obtained by other connections. This method of control provides an extremely smooth and rapid variation of voltage output, but is accomplished at some expense of power factor and wave form. (Fig. 23 and 24).

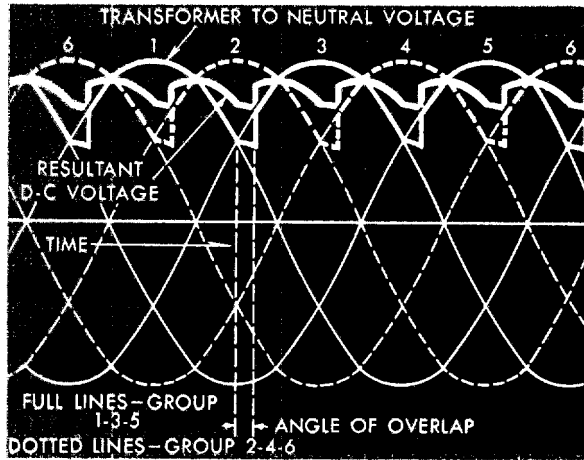

FIG. 23—Wave shape with zero ignitor delay.

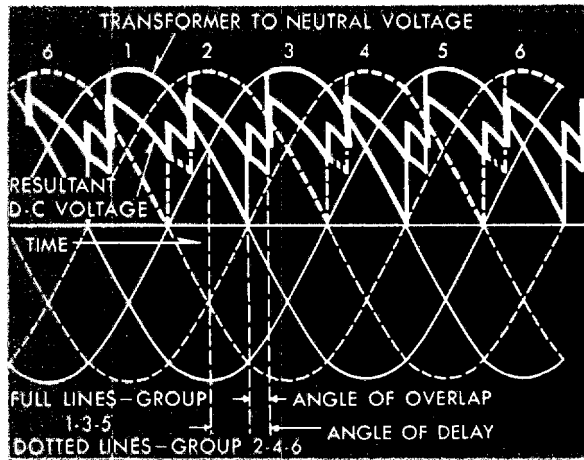

FIG. 24—Wave shape with 30° ignitor delay.

The normal rectifier regulation can be made to parallel with other forms of conversion apparatus with the usual shunt characteristic. Through use of ignition control, it is possible to obtain parallel operation with machines having various degrees of compounding. Since the d-c output voltage of synchronous converters and rectifiers depends upon the high line voltage in the same manner, parallel operation of a rectifier with a converter is simpler than with a motor generator, the d-c voltage of which is independent of the high line voltage.

## EFFICIENCY

Efficiency of an Ignitron Rectifier unit is the ratio of the power output at the d-c terminals to the power input at the high tension terminals of the transformer. Component losses of the unit included in the efficiency calculations are: the copper and iron losses of the transformer equipment, the loss in the rectifier arc and the power for operation of the standard rectifier auxiliaries.

For a given kilowatt output, the efficiency of any arc rectifier unit improves as the direct-current voltage is increased. Losses of the transformer are in proportion to kilowatts, but the arc loss of the rectifier is practically in proportion to d-c amperes. The lower the ratio of d-c amperes to kilowatts, the higher the efficiency.

Throughout the normal load range, the arc volts drop is practically constant, there being only several volts difference in arc-drop between light load and full load. The volts drop in the arc at any given d-c ampere load is determined by rectifier design.

For 250-volt d-c operation, the Ignitron unit efficiency is higher than that of a motor generator set throughout the normal load range. It is higher than the efficiency of a synchronous converter up to 75% load, and lower beyond 75% load.

For 600-volt, d-c operation, the Ignitron unit efficiency is higher than that of a motor generator set throughout the normal load range. It is higher than the efficiency of a synchronous converter throughout the normal load range.

For operation at d-c voltages above the 600-

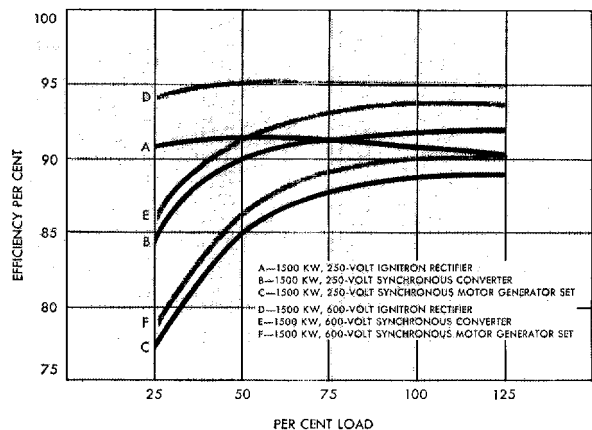

FIG. 25—Typical efficiency curves of 1500-kw, 250-volt and 1500-kw, 600-volt Ignitron units. The influence of voltage

volt d-c class, the Ignitron unit efficiency is higher than that of all rotating conversion units throughout the normal load range.

Due to the considerably higher efficiency of the Ignitron unit as compared with rotating units at light loads, its application is particularly advantageous on low load factor installations.

## POWER FACTOR

The power factor of a rectifier installation is determined by the operating conditions, the transformer characteristics and connections, and the constants of the supply circuit. Power factor of a rectifier is generally understood to be the ratio of input power to the product of the rms voltage and rms amperes of the a-c supply. Consequently, power factor depends upon both reactive volt-amperes and effects of wave distortion. Fig. 26 shows the power factor of typical six-phase and twelve-phase rectifiers supplied from a large a-c system.

## RATINGS

Rectifiers are rated according to the standards which apply in the service for which they are intended. In case the accepted standards do not fit the expected loading, special ratings may be used. Rated overloads and high momentary swings have no injurious effects on mercury arc rectifiers—in contrast to rotating machinery—so overloads specified in the rat-

ings are available for regular operation without involving additional maintenance costs. Overload cycles must be separated by intervals of full load or less operation of sufficient length to permit the rectifier and transformer to reach normal full load temperatures.

## RECTIFIER HARMONICS

The d-c output voltage and a-c supply current contain harmonics which are inherent in the operation of a rectifier and are similar to the slot or commutator ripples or other harmonics produced by rotating machines. These harmonics are of relatively small magnitude and may be safely ignored in the majority of installations. If the rectifier constitutes a large percentage of the total load on the power supply system, however, it may be desirable to give consideration to the possibility of increased heating in the a-c generator.

There is also the possibility that harmonics from a rectifier may give rise to an inductive co-ordination problem if either d-c or a-c supply lines of the rectifier are located in close proximity to communication circuits. This problem together with other noise problems has received careful consideration by power and communication system engineers. In general, these problems may be solved by means applicable to (1) the power system, (2) the communication system, (3) the coupling between the systems, or a combination of these methods.

Where a wave shape problem is encountered and remedial measures applicable to power supply equipment are indicated, these will take the form of a larger number of phase positions in the rectifier, where this is possible, or of filtering equipment. To reduce harmonics in the d-c circuits, filtering equipment would include one or more shunt elements, each consisting of a reactor and capacitor connected in series and tuned to a harmonic frequency.

The resonant shunts will ordinarily be used in combination with a reactor connected in the main d-c circuit. To reduce the harmonics in the a-c circuit, the filter equipment will consist of one or more sets of tuned shunt elements connected across each of the three phases of the supply. Experience has proved that filters for the a-c circuits are rarely required.

FIG. 26—Typical power-factor curves.

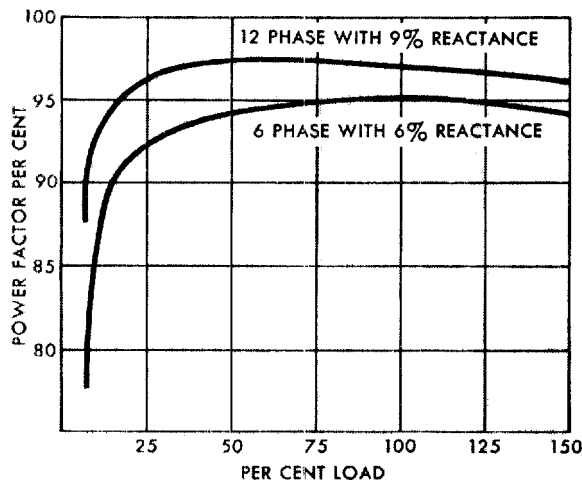



# SWITCHING EQUIPMENT

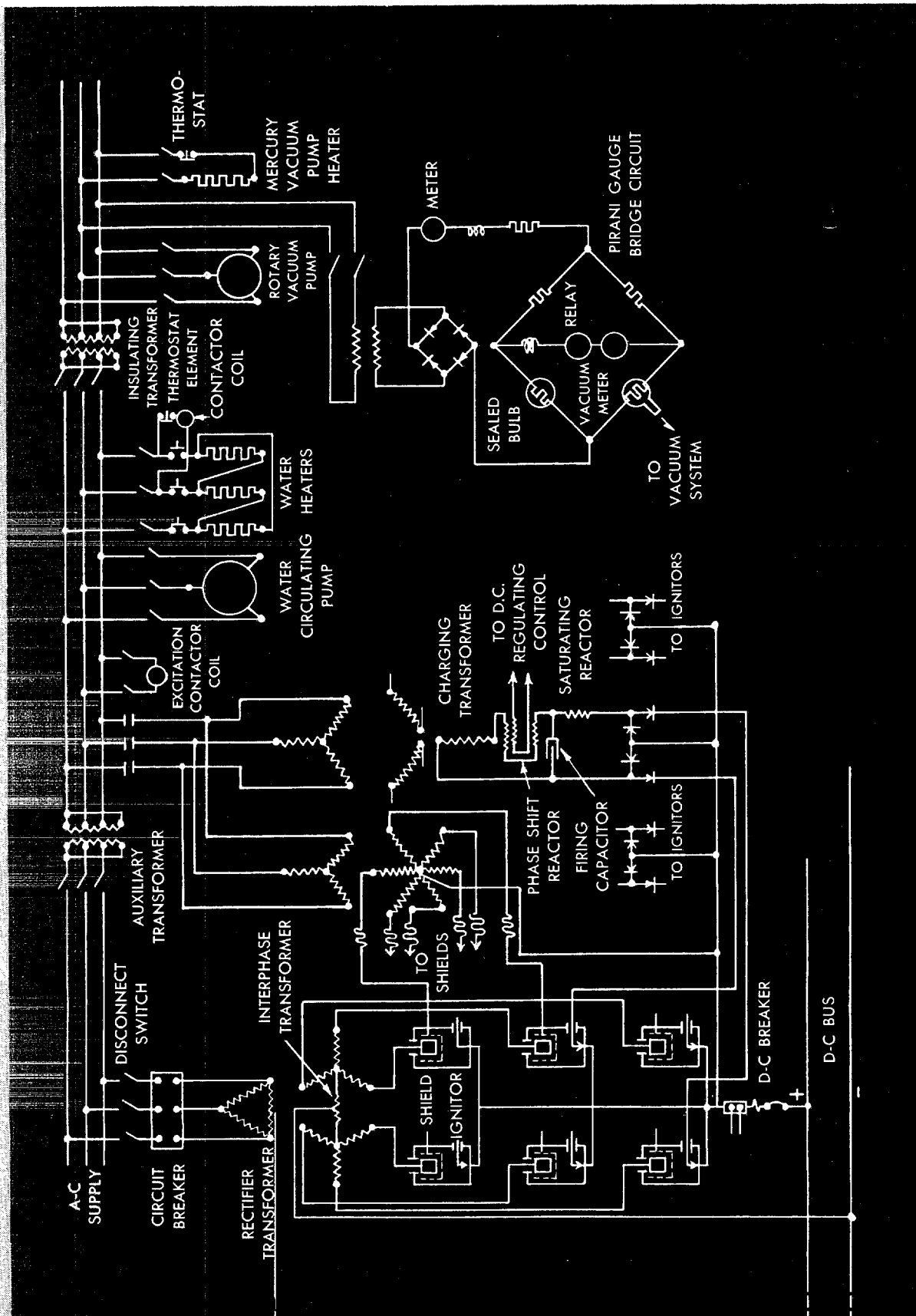

FIG. 27 - Ignitron Rectifier control equipment.

## Switching Equipment

Switching equipment is available to meet the various applications ranging from manual to full automatic control. Automatic control of an Ignitron Rectifier station is very simple.

In a manually controlled station the operator is responsible for performing in their proper sequences the various steps required to place the unit in operation. The vacuum pumping system normally is in continuous operation. This is true with both manual and automatic control, and regardless of whether the rectifier is carrying load or is shut down. (Fig. 27).

Placing the Ignitron in service, the operator first checks the system vacuum to see that it is within safe operating limits. He then closes the high tension a-c breaker which energizes the main power transformer so that potential is applied to the rectifier anodes. The excitation equipment is next placed in operation. Ignition of the main anodes follows, and then the d-c line breaker is closed. This completes the starting operation and the rectifier now delivers its share of the load to the system.

## Full Automatic Control

When full automatic control is supplied, all of the above operations are performed automatically. The Ignitron is placed in operation or shut down by one or more of the usual methods. Among the most common of these are undervoltage starting and light load stopping, remote pushbutton control and supervisory control.

Various degrees of semiautomatic control are available also to supply the demand for this

type of equipment. Generally speaking, these forms of control require an operator to place them in service, after which they operate without attention until taken out of service, either by the operator or due to operation of one or more of the protective devices.

Even in manually operated stations many of the automatic features usually are retained, for instance a provision for shutting down a unit in the event of loss of vacuum or overtemperature, although frequently the arrangement is such that these conditions sound an alarm.

## Protective Devices

With full automatic control, full protection must be provided to take care of any emergency that may arise. These protective features can be divided into two classes. Those in the first group prevent the rectifier from operating until after the emergency has passed, when it is again released for service. Functioning of a device in the second class effects a complete station lockout until someone visits the station to correct the trouble and reset the lockout relay. Devices of this class are reduced to a minimum with Ignitron Rectifiers.

The design of control and protective equipment for an Ignitron Rectifier, while eliminating a great many features necessary for the control and protection of rotating machines, introduces a number of considerations not encountered in connection with this type of conversion apparatus. These differences have been recognized and suitable apparatus developed to provide the same surety of protection, correctness of sequence and high degree of service reliability which characterize Westinghouse automatic switching for other classes of equipment.

# FOR COMPLETE INFORMATION ON IGNITRON RECTIFIERS

## SEE THE WESTINGHOUSE OFFICE NEAR YOU

LOCATION	ADDRESS	TELEPHONE	LOCATION	ADDRESS	TELEPHONE
AKRON 8, OHIO,	106 S. Main St.	Jefferson 3165	LOUISVILLE 2, KY.,	332 West Broadway	Clay 0212
ALBANY 4, N. Y.,	456 N. Pearl St.	5-1597	MADISON 3, WIS.,	1022 E. Washington Ave.	Badger 4990
ALBUQUERQUE, N. M.,	1115½ E. Central Ave.	3-1826	MEDFORD, OREGON,	38 N. Bartlett St., P. O. Box 1308	8-289
ALLENTOWN, PA.,	739 Hamilton St.	4-5108	MEMPHIS 3, TENN.,	825 Exchange Bldg.	8-8546
AMARILLO, TEXAS,	303 Amarillo Bldg.	7838	MIAMI 4, FLA.,	11 N. E. Sixth St.	8-23691
APPLETON, WIS.,	321 West College Ave., P. O. Box 206	4-4116	MIDDLESBORO, KY.,	2019 Cumberland Ave., P. O. Box 517	221
ATLANTA 2, GA.,	1299 Northside Drive, N. W.	Atwood 1642	MILWAUKEE 2, WIS.,	538 N. Broadway	Daly 8-1800
AUGUSTA, MAINE,	9 Bowman St.	2463	MINNEAPOLIS 13, MINN.,	2303 Kennedy St., N. E.	Granville 3545
BAKERSFIELD, CALIF.,	2224 San Emidio St.	2-4381	MOBILE, ALA.,	171 Emogene Place	6-2215
BALTIMORE 2, MD.,	501 St. Paul Place	Plaza 0300	NASHVILLE 3, TENN.,	6th Ave. at Shirley St.	42-3505
BEAUMONT, TEXAS,	515 American National Bank Bldg.	41481	NEWARK 2, N. J.,	1180 Raymond Blvd.	Market 2-0200
BINGHAMTON 6, N. Y.,	704 Marine Midland Bldg.	2-6403	NEW HAVEN 10, CONN.,	42 Church St.	5-3191
BIRMINGHAM 3, ALA.,	1407 Comer Bldg.	3-8137	NEW ORLEANS 13, LA.,	238 South Saratoga Street	Raymond 8656
BLUEFIELD, W. VA.,	704 Bland St., P. O. Box 848	39131	NEW YORK 5, N. Y.,	40 Wall St.	Whitehall 3-4321
BOSTON 10, MASS.,	10 High St.	Liberty 2-0600	NIAGARA FALLS, N. Y.,	253 Second St.	9700
BRIDGEPORT 8, CONN.,	540 Grant St.	4-0151	NORFOLK 10, VA.,	915 W. 21st St.	5-1639
BUFFALO 3, N. Y.,	814 Ellicott Sq. Bldg.	Washington 3966	OKLAHOMA CITY 2, OKLA.,	120 N. Robinson St.	7-1633
BUTTE, MONT.,	1 East Broadway	2-2301	OMAHA 2, NEBR.,	117 North Thirteenth St.	Harney 8700
CANTON 2, OHIO,	120 W. Tuscarawas St.	39171	PEORIA 2, ILL.,	418 S. Washington St.	7116
CEDAR RAPIDS, IOWA,	512 Dows Bldg., P. O. Box 1828	7638	PHILADELPHIA 4, PA.,	3001 Walnut St.	EVERgreen 2-1200
CHARLESTON, S. C.,	89 G. Smith St.	9904	PHOENIX, ARIZ.,	11 West Jefferson St.	4-3158
CHARLESTON 1, W. VA.,	179 Sumner St., P. O. Box 911	37-565	PITTSBURGH 30, PA.,	306 Fourth Ave.	Atlantic 1-8400
CHARLOTTE 1, N. C.,	210 E. Sixth St.	5-3731	PORTLAND 4, ORE.,	309 S. W. Sixth Ave.	Atwater 9464
CHATTANOOGA 2, TENN.,	Volunteer State Life Bldg.	7-4361	PROVIDENCE 3, R. I.,	16 Elbow St.	Gaspee 1-0818
*CHICAGO 6, ILL.,	20 N. Wacker Drive	Franklin 2-5520	RALEIGH, N. C.,	803 North Person St.	6-302
CINCINNATI 2, OHIO,	207 W. Third St.	Garfield 2250	READING, PA.,	4th and Elm Sts.	7236
CLEVELAND 13, OHIO,	1370 Ontario St.	Cherry 1-7600	RICHMOND 19, VA.,	1110 E. Main St.	2-4758
COLUMBUS 15, OHIO,	262 N. Fourth St.	Main 4134	ROANOKE 4, VA.,	Kirk Ave. and First St., P. O. Box 599	6263
CORPUS CHRISTI, TEXAS,	416 N. Chaparral St.	3-9237	ROCHESTER 7, N. Y.,	1048 University Ave.	Monroe 1635
DALLAS 1, TEXAS,	209 Browder St.	Randolph 4161	ROCKFORD, ILL.,	323 S. Main St.	2-3452
DAVENPORT, IOWA,	2212 E. 12th St., P. O. Box 29	3-2761	RUTLAND, VT.,	98 Merchants Row	3292
DAYTON 2, OHIO,	32 North Main St.	Adams 9153	SACRAMENTO 14, CALIF.,	1720 Fourteenth Street	Gilbert 3-6525
DENVER 2, COLO.,	910 Fifteenth St.	Keystone 8121	SAGINAW, MICH.,	124 So. Jefferson St.	4-2640
DES MOINES 8, IOWA,	1400 Walnut St.	2-0244	ST. LOUIS 1, MO.,	411 North Seventh St.	Central 1120
DETROIT 31, MICH.,	5757 Trumbull Ave., Box 828	Trinity 2-7010	SALT LAKE CITY 1, UTAH,	235 West South Temple St.	5-3413
DULUTH 2, MINN.,	10 East Superior St.	Melrose 821	SAN ANTONIO 5, TEXAS,	115 West Travis Street	Garfield 5114
EL PASO, TEXAS,	718 Mills Bldg.	2-5691	SAN DIEGO 1, CALIF.,	861 Sixth Ave.	Main 8151
EMERYVILLE 8, CALIF.,	5815 Peladeau St.	Olympic 2-3770	SAN FRANCISCO 8, CALIF.,	410 Bush St.	Exbrook 2-5353
ERIE, PA.,	1003 State St.	24-867	SEATTLE 4, WASH.,	3451 East Marginal Way	Main 0808
EVANSVILLE 8, IND.,	106 Vine St.	5-7146	SHREVEPORT, LA.,	222 Spring St.	4-5298
FAIRMONT, W. VA.,	10th and Beltline	501	SIOUX CITY 4, IOWA,	1005 Dace St.	5-7634
FERGUS FALLS, MINN.,	101½ W. Lincoln St.	4250	SOUTH BEND 4, IND.,	216 E. Wayne St.	3-7167
FORT WAYNE 2, IND.,	610 S. Harrison St.	Anthony 3421	SPOKANE 8, WASH.,	1023 W. Riverside Ave.	Main 3294
FORT WORTH 2, TEXAS,	408 West Seventh Street	Fortune 4086	SPRINGFIELD, ILL.,	517 Illinois Bldg., P. O. Box 37	3-1532
FRESNO 1, CALIF.,	2608 California Ave.	6-6489	SPRINGFIELD 3, MASS.,	26 Vernon St.	6-8373
GARY, IND.,	846 Broadway	2-1468	SYRACUSE 4, N. Y.,	700 W. Genesee St.	2-1361
GRAND RAPIDS 2, Mich.,	148 Monroe Ave., N. W.	9-3106	TACOMA 2, WASH.,	1930 Pacific Ave.	Broadway 6565
GREENSBORO, N. C.,	1008 Pamlico Drive	2-3415	TAMPA 1, FLA.,	909 Wallace S. Bldg., 608 Tampa St.	2-2542
GREENVILLE, S. C.,	160 W. Tallulah Drive	3-7755	TOLEDO 4, OHIO,	245 Summit St.	Garfield 4625
HAMMOND, IND.,	235 Locust St.	Russell 8937	TRENTON 10, N. J.,	1100 S. Broad St.	2-4136
HARTFORD 3, CONN.,	119 Ann St.	7-8141	TULSA 3, OKLA.,	619 S. Main St.	3-3191
HOUSTON 2, TEXAS,	1314 Texas Ave.	Charter 4691	UTICA 1, N. Y.,	113 N. Genesee St.	4-1194
HUNTINGTON 1, W. VA.,	1029 Seventh Ave., P. O. Box 1150	7146	WALLA WALLA, WASH.,	17 N. Second Ave., P. O. Box 182	5-5124
INDIANAPOLIS 9, IND.,	137 S. Pennsylvania Street	Market 3301	WASHINGTON 5, D. C.,	1625 "K" St., N. W.	National 8843
JACKSON, MICH.,	180 West Michigan Ave.	2-0519	WATERLOO, IOWA,	300 W. Third St.	4679
JACKSON, MISS.,	P. O. Box 4296, Fondren Sta.	2-3527	WATERTOWN, N. Y.,	245 State St.	1400
JACKSONVILLE 3, FLA.,	37 South Hogan St.	3-7431	WHEELING, W. VA.,	12th and Main Sts., P. O. Box 329	6222-6223
JAMESTOWN, N. Y.,	300 Wellman Bldg., 101 West 3rd St.	3042	WICHITA 2, KANSAS,	301 S. Market St.	5-2631
JOHNSTOWN, PA.,	107 Station St.	81-257	WILKES-BARRE, PA.,	267 N. Pennsylvania Ave.	3-1144
KANSAS CITY 6, MO.,	101 W. Eleventh Street	Harrison 7122	WILLIAMSPORT 1, PA.,	348 W. Fourth St.	4289
KNOXVILLE 8, TENN.,	605 Burwell Bldg.	2-8101	WORCESTER 8, MASS.,	507 Main St.	4-2648
LITTLE ROCK, ARK.,	707 Boyle Bldg.	4-0368	YORK, PA.,	11 W. Market St.	7851
LOS ANGELES 17, CALIF.,	600 St. Paul Avenue	Madison 6-3881	YOUNGSTOWN 3, OHIO,	25 E. Boardman St.	4-1118

\*After March 1, 1951: Mdse. Mart Plaza, Chicago 54, Illinois

*Westinghouse* **IGNITRON RECTIFIERS**

Approved For Release 2011/03/09 : CIA-RDP80-00420R001500330028



0123R001900030002-6

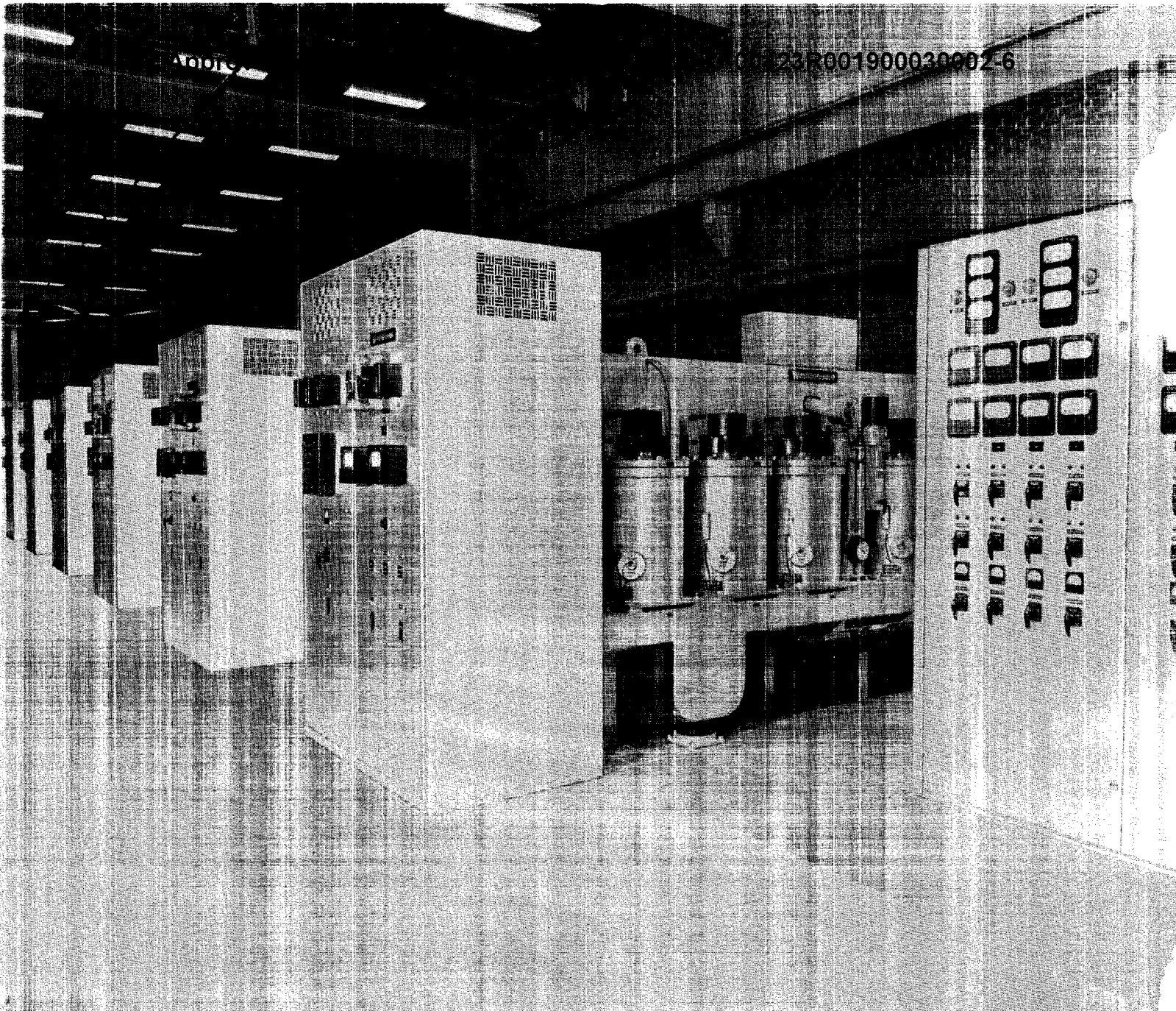

# Westinghouse Electric Corporation

EAST PITTSBURGH, PENNA.



Approved For Release 2001/03/06 : CIA-RDP83-00423R001900030002-6

<del>RESTRICTED</del> <del>CONFIDENTIAL</del> <del>SECRET</del>		
<b>ROUTING AND CONTROL RECORD</b>		
DO NOT DETACH FROM 'ON LOAN' DOCUMENTS		
<u>21 April 1955</u> <small>DATE</small>		
<b>T0:</b>		
Graphics Register		25X1A9a
<b>ATTN:</b> [REDACTED]		
<b>BUILDING</b>	[REDACTED]	<b>ROOM NO.</b>
<b>TITLE</b>		
Pictures of 6,000 Ampere Ignitron Built in US for USSR 25X1A2g      25X1A2g [REDACTED]      [REDACTED]		
<b>REMARKS</b> R-23853		
<input checked="" type="checkbox"/> <b>RETAIN</b>	<input type="checkbox"/> <b>ON LOAN</b>	
<b>DOCUMENT(S) FOR RETENSION BY ADDRESSEE</b>	DOCUMENT(S) MUST BE RETURNED TO CONTACT DIVISION/OO BY (DEADLINE)	
	25X1A8a    25X1A9a	
<b>FROM:</b> CONTACT DIVISION/OO [REDACTED]		
<b>BUILDING</b>	<b>ROOM NO.</b>	<b>EXTENSION</b>
Quarters Eye	1808	2576

FORM NO. 57-29  
DEC 1951

(20-40)

*Handwritten notes:*  
R  
K  
H  
A  
B  
C  
D  
E  
F  
G  
H  
I  
J  
K  
L  
M  
N  
O  
P  
Q  
R  
S  
T  
U  
V  
W  
X  
Y  
Z

25X1A2g

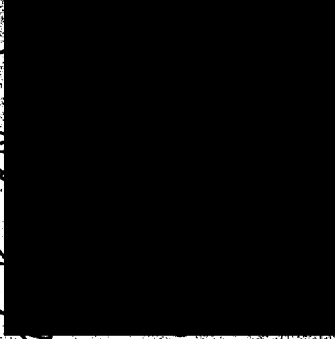

25X1A9a

*Handwritten:* 2191H