

ZAMOYSKY, A.

POLAND / Organic Chemistry. Organic Synthesis. G

Abs Jour: Ref Zhur-Khimiya, No 12, 1958, 39575.

Author : Akhmatovich O., Leplyavy, M., Zamoysky A.  
 Inst : Polish Academy of Sciences.  
 Title : Chemistry of Cyanocarbonyl. I. Reaction Between  
 Cyanocarbonyl and  $\alpha$ -methyl styrol and Allyl-  
 benzene.

Orig Pub: Byul. Polsk. A.N., 1955, Otd. 3,3, No 10, 535-542.

Abstract: In the reaction of  $\alpha$ -methyl styrol (I) in a hexane solution at  $\sim 20^\circ\text{C}$  with one mole of  $\text{CO}(\text{CN})_2$  (II) one obtains  $\text{CH}_2=\text{C}(\text{C}_6\text{H}_5)\text{CH}_2\text{CO}\cdot\text{CN}$  (III). The fact is verified by the hydrolysis of (III) ( $\sim 20^\circ\text{C}$ ) in dioxane to  $\text{CH}_2=\text{C}(\text{C}_6\text{H}_5)\text{CH}_2\text{COOH}$  (IV) and isomeriza-

Card 1/3

POLAND / Organic Chemistry. Organic Synthesis G

Abs Jour: Ref Zhur-Khimiya, No 12, 1958, 39575.

APPROVED FOR RELEASE: 09/19/2001 CIA-RDP86-00513R001963720016-6

Abstract: tion of (III) (heating to  $130^\circ\text{C}$ ) into  $\beta$ -methyl cinnamyl cyanide, M.P.  $40-42^\circ\text{C}$ . In the reaction of (I) with 2 moles of (II) as well as of (III) with (II) ( $\sim 20^\circ\text{C}$ ),  $\text{C}_6\text{H}_5\text{C}(\text{=CH}_2)\text{CH}_2\text{C}(\text{CN})_2\text{OCOCN}$  (V), is formed, yield 77 and 80% respectively, M.P.  $76.5^\circ\text{C}$ . (V) with the reaction ( $\sim 20^\circ\text{C}$ ) of 2 moles of aniline forms  $\beta$ -phenylvinylacetanilid (VI), formanilidcyanide, and HCN, at the excess of aniline forms (VI), diphenylurea and HCN.

When (V) is treated with 10%  $\text{NH}_4\text{OH}$ , one obtains  $\text{CH}_2=\text{C}(\text{C}_6\text{H}_5)\text{CH}_2\text{CONH}_2$ ; when treated with  $\text{C}_6\text{H}_5\text{NHNH}_2$ , obtained are  $\text{CH}_2=\text{C}(\text{C}_6\text{H}_5)\text{CH}_2\text{CONHNHC}_6\text{H}_5$  and  $\text{CO}(\text{NHNHC}_6\text{H}_5)_2$ . The hydrolysis of (V) in dioxane leads to the formation of (IV) HCN and  $\text{CO}_2$ . Allylbenzene (VII) reacts simultaneously with 2 moles

Card 2/3

22

POLAND / Organic Chemistry. Organic Synthesis. G

Abs Jour: Ref Zhur-Khimiya, No 12, 1958, 39575.

ZIMYSHI, T.

"Weekday in a Factory Library", p. 249; "Questionnaire of State Technical Publications and Horizonty Techniki on Reading Awards", p. 253, (HORIZONTY TECHNIKI, Vol. 7, No. 5, 1954, Warszawa, Poland)

SO: Monthly List of East European Accessions, (REAL), IC, Vol. 4, No. 5, May 1955, Uncl.

Z. B. MOY/SKI, T.

Zamoyski T.

Zamoyski T., Eng. "The Development of the Polish Chemical Industry." (Rozwoj przemyslu chemicznego w Polsce). Przemysl Chemiczny, No 6, 1950, pp. 309-317, 2 tabs.

Conditions of development of the chemical industry in Poland before the 1-st World War and during the period between the two wars. The part played by foreign capital and its impact on the Polish chemical industry, specially considering production of soda, sulphuric acid, coalstar derivatives, organic intermediates, dyestuffs, pharamaceuticals, fats, artificial fibres and matches. The position of the chemical industry after the second war and at present.

SO: Polish Technical Abstracts No. 2, 1951

ZAMOYSKI, T.

More extensive reading will accelerate technical progress. p. 132.  
Vol 8, no. 5, May 1955. CHEMIK. Katowice, Poland.

So: Eastern European Accession. Vol 5, no. 4, April 1956

ZAMOYSKI, T.

"Fighting for a New Reader." p. 205 (HORYZONTY TECHNIKI, Vol. 6, No. 5, May 1953)  
Warszawa

SO: Monthly List of East European Accessions, Library of Congress, Vol. 2, No.10,  
October 1953. Unclassified.

ZAMOYSKI, Tadeusz, mgr inż.

International congresses of industrial chemistry. Problemy 20  
no.5:304-305 '64

OLSZEWSKA, Barbara; ZAMOYSKI, Tadeusz

Edmund Trepka; 1880-1964, Swart hist nauki i tech 9 no.3/4:379-382  
'64

ZAMOYSKI, Tadeusz, mgr inż.

The Thirty-fifth International Congress of Industrial Chemistry.  
Problemy 20 no.11:700-703 '64.



ZAMOYSKI, T.

"Contribution of Poland to the Development of Chemistry; some Materials for Debates at the First Polish Congress of Science." p. 380 (~~Problemy~~ Vol. 8, no. 6 1952, Warszawa.)

Vol. 3, no. 6

SO: Monthly List of East European Accessions./Library of Congress, June 1954, Uncl.

ZAMOYSKI, T.

"Review of technical books", p. 430 (Przegląd Techniczny. Vol. 74, no. 11, Nov. 1953, Warszawa)

Vol. 3, No. 3  
SO: Monthly List of East European Accessions, /Library of Congress, March 1954, Uncl.

ZAMOYSKI, T.

"Role of technical associations in propagating technical books." p. 186. (Przeład Techniczny, Vol. 74, no. 5, May 53, Warszawa)

SO: Monthly List of East European Accessions, Vol 3 No 6 Library of Congress Jun 54 Uncl

13

CA

Foreign capital invested in the Polish chemical industry.  
T. Zamiatycki, *Przemysl Chem.* 6(29), 309-17(1953).  
The present status of the Polish chem. industry is reviewed.  
Frank Gonet

P. T. A

*Chemistry & Chemical Technology*  
7

338

66

Zamoyski T., Eng. The Development of the Polish Chemical Industry. "Rozwój przemysłu chemicznego w Polsce". Przemysł Chemiczny. No 6, 1950, pp. 309-317, 2 tabs.

Conditions of development of the chemical industry in Poland before the 1-st World War and during the period between the two wars. The part played by foreign capital and its impact on the Polish chemical industry, specially considering production of soda, sulphuric acid, coal-tar derivatives, organic intermediates, dyestuffs, pharmaceuticals, fats, artificial fibres and matches. The position of the chemical industry after the second war and at present.

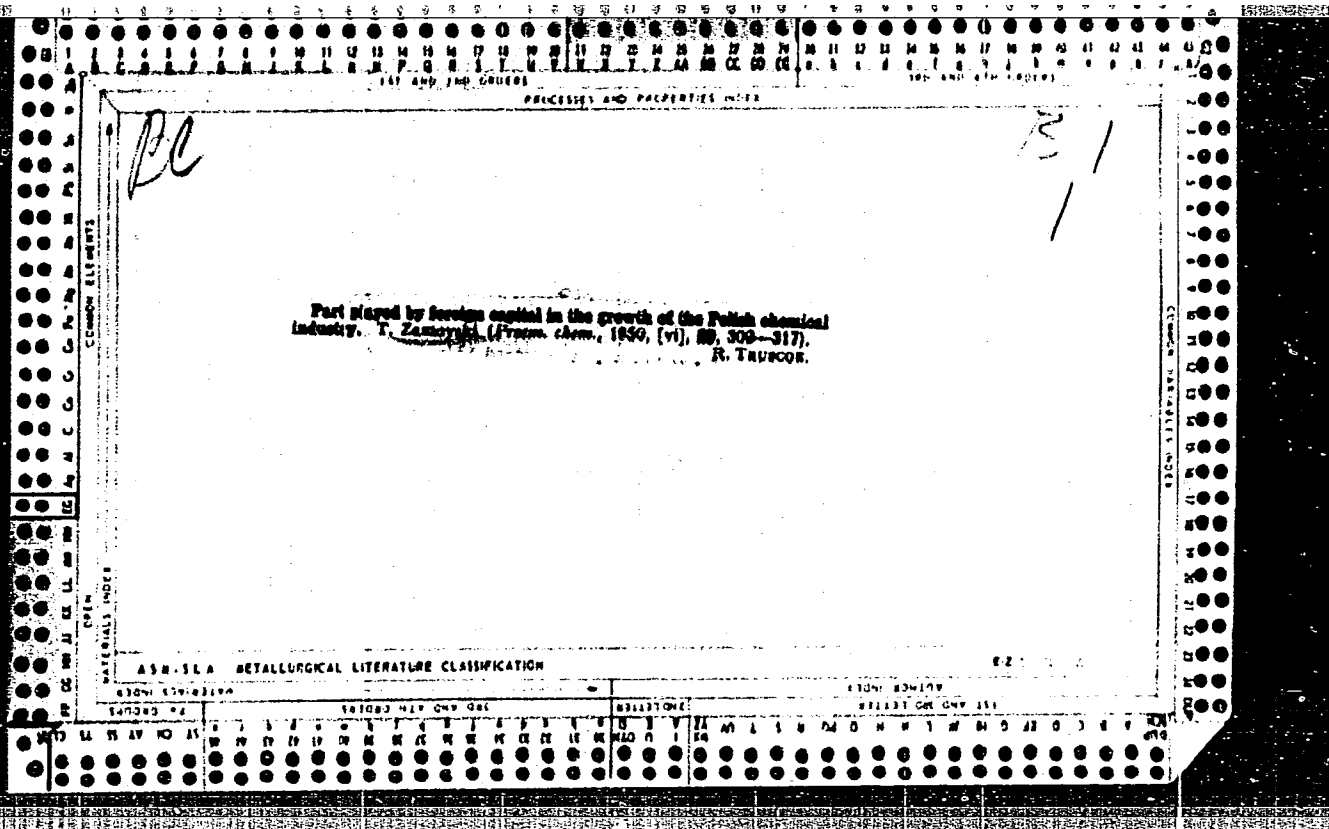

1ST AND 2ND SECTS      PROCESSES AND PROPERTIES INDEX      3RD AND 4TH SECTS

BC      BT  
/

Classification of documents. T. Zamoysh (Przem. chem., 1950, (vi), 20, 515-518).—The Decimal system of indexing is described. R. Tauscor.

ASB-SLA METALLURGICAL LITERATURE CLASSIFICATION

1ST AND 2ND SECTS      3RD AND 4TH SECTS

1	2	3	4	5	6	7	8	9	10	11	12	13	14	15	16	17	18	19	20	21	22	23	24	25	26	27	28	29	30	31	32	33	34	35	36	37	38	39	40	41	42	43	44	45	46	47	48	49	50	51	52	53	54	55	56	57	58	59	60	61	62	63	64	65	66	67	68	69	70	71	72	73	74	75	76	77	78	79	80	81	82	83	84	85	86	87	88	89	90	91	92	93	94	95	96	97	98	99	00
---	---	---	---	---	---	---	---	---	----	----	----	----	----	----	----	----	----	----	----	----	----	----	----	----	----	----	----	----	----	----	----	----	----	----	----	----	----	----	----	----	----	----	----	----	----	----	----	----	----	----	----	----	----	----	----	----	----	----	----	----	----	----	----	----	----	----	----	----	----	----	----	----	----	----	----	----	----	----	----	----	----	----	----	----	----	----	----	----	----	----	----	----	----	----	----	----	----	----	----

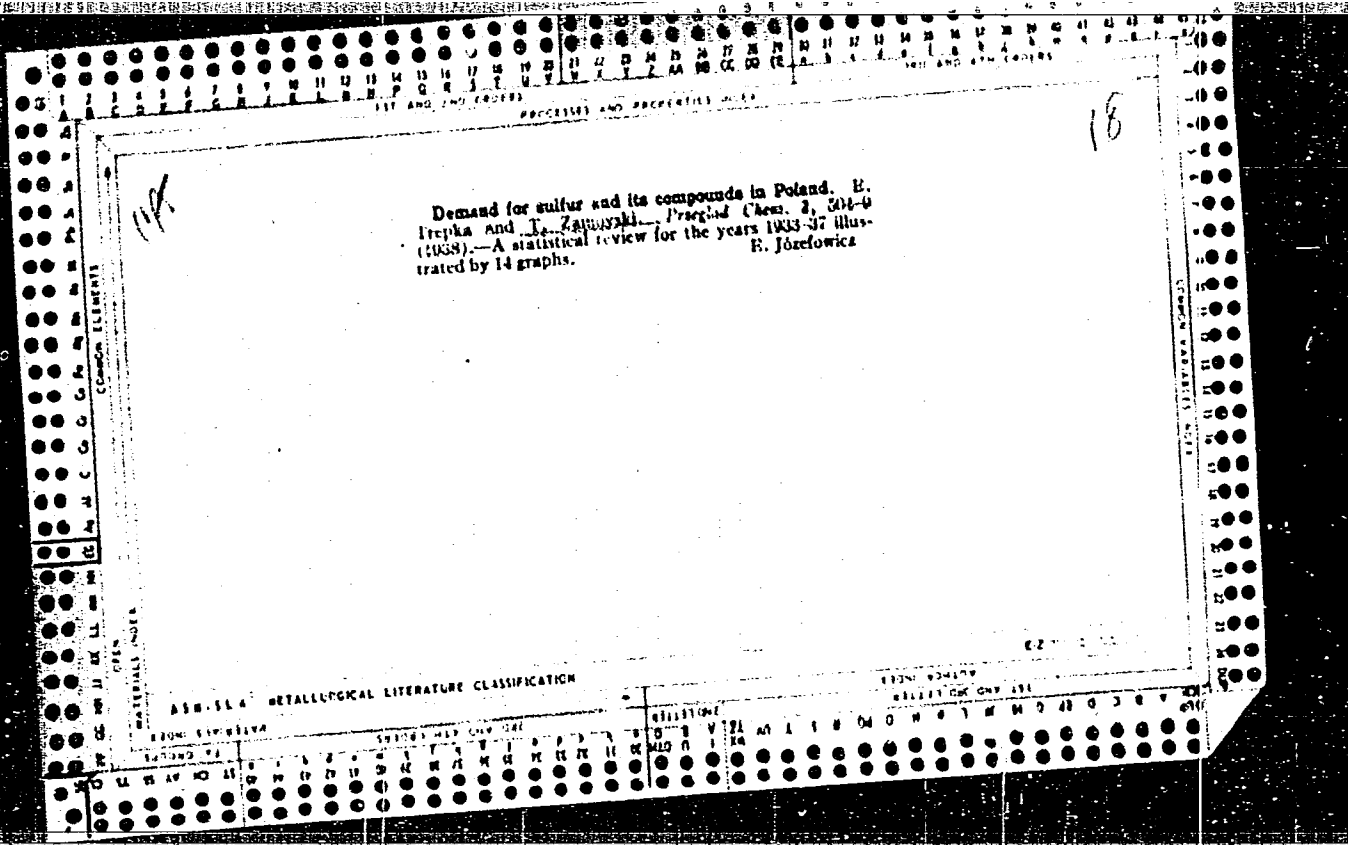



PROCESSES AND PROPERTIES INDEX

1ST AND 2ND ORDERS

100 AND 5TH ORDERS

CA

19

The chemical industry in Poland. TADUSZ ZAMOYSKI. Chem. Listy 25, 455-6. 475-8, 606-11(1931).

ASB-SLA METALLURGICAL LITERATURE CLASSIFICATION

EXONUM SCHLICH

EXONUM SCHLICH

1	2	3	4	5	6	7	8	9	10	11	12	13	14	15	16	17	18	19	20	21	22	23	24	25	26	27	28	29	30	31	32	33	34	35	36	37	38	39	40	41	42	43	44	45	46	47	48	49	50	51	52	53	54	55	56	57	58	59	60	61	62	63	64	65	66	67	68	69	70	71	72	73	74	75	76	77	78	79	80	81	82	83	84	85	86	87	88	89	90	91	92	93	94	95	96	97	98	99	100
---	---	---	---	---	---	---	---	---	----	----	----	----	----	----	----	----	----	----	----	----	----	----	----	----	----	----	----	----	----	----	----	----	----	----	----	----	----	----	----	----	----	----	----	----	----	----	----	----	----	----	----	----	----	----	----	----	----	----	----	----	----	----	----	----	----	----	----	----	----	----	----	----	----	----	----	----	----	----	----	----	----	----	----	----	----	----	----	----	----	----	----	----	----	----	----	----	----	----	-----

ZAMOYSKI, Tadeusz, mgr inż.

Center of French scientific and technological documentation.  
Problemy 19 no.12:776-777 '63.

1. Dyrektor Osrodka Francuskiej Dokumentacji Naukowo-  
Technicznej, Warszawa.

ZAMOYSKI, Tadeusz

The Polish export of chemicals. Przem chem Special issue:  
3-6 '58.

ZAMOYSKIY, N.A.

Evaluation of Reed-Kuench method in determining the activity of biological preparations. Zhur. mikrobiol., epid. i immun. 27 no.1: 77-83 Ja '56 (MLBA 9:5)

1. Iz tsentral'nogo instituta usovershenstvovaniya vrachey i bakteriologicheskoy laboratorii (nach.-kandidat meditsinskikh nauk N.A. Kukhterin)

(BIOLOGICAL PRODUCTS, effects, standard., Reed-Kuench method (Rus))

L 18719-63 EWT(1)/EWP(q)/EWT(m)/BDS/EED-2 AFFTC/ASD/ESD-3 JD/JG  
8/0181/63/005/007/2012/2015

ACCESSION NR: AP3003905

AUTHORS: Klevtsov, P. V.; Zamozhskiy, V. D.

TITLE: The nature of hydrothermal etching figures in ferrite crystals with garnet structure

SOURCE: Fizika tverdogo tela, v. 5, no. 7, 1963, 2012-2015

TOPIC TAGS: hydrothermal etching, etching figure, ferrite, crystal, garnet, etch pit, orthorhombic dodecahedron, tetragonal trioctahedron, selectivity, autoclave, dislocation

ABSTRACT: The authors have made a study of surface structure because it furnishes information on the actual structure and growth processes in garnet crystals under hydrothermal conditions. They studied garnet ferrite crystals under the microscope as the surfaces are subjected to hydrothermal and chemical etching. A characteristic feature of this etching under hydrothermal conditions is its selectivity. Etch pits have a well-defined rhombic pyramidal shape, the sides of the pyramidal base being parallel to the edges of the intersection between the face being treated and the adjoining rhombic dodecahedral or tetragonal trioctahedral {011} faces. The pits are chaotically distributed, but occur also along lines in series similar to

65  
63

Card 1/2

L 18719-63

ACCESSION NR: AP3003905

2

etch pits at the emergent sites of dislocations along subgrain boundaries. In these series the apices of pits lie between 0.3 and 3  $\mu$  apart, the distance differing for various crystals. Selective chemical etching supports the view that these pits are of dislocation character. Dislocations in crystals of magnetic garnets may appear through treatment (in an autoclave) of crystals by solutions of various salts at high temperatures and pressures. Orig. art. has: 2 photographs.

ASSOCIATION: Institut neorganicheskoy khimii SO AN SSSR, Novosibirsk (Institute of Inorganic Chemistry, Siberian Department, Academy of Sciences, SSSR)

SUBMITTED: 03Jan63

DATE ACQ: 15Aug63

ENCL: 00

SUB CODE: PH

NO REF SOV: 002

OTHER: 000

Card 2/2

S/181/63/005/001/050/064  
B108/B180

AUTHORS: Klevtsov, P. V., and Zamozhskiy, V. D.

TITLE: Selective etching of magnetic garnet crystals

PERIODICAL: Fizika tverdogo tela, v. 5, no. 1, 1963, 339-340

TEXT: Due to lack of a good method of revealing dislocations, little is known about the effect of structural defects on the physical properties of garnet-type ferrites. The authors therefore sought to find an etching agent that reacts on structural defects. Ferrite-garnets of yttrium, gadolinium, and dysprosium were rinsed and then etched. Two agents produced good results. The first, (1), had 3 parts 55-% nitric acid, 1 part HCl (35.4%) and 1 part  $\text{FeCl}_3$ ; etching time 10 - 15 min. To increase selectivity aliquot quantities were added, of substances which would reduce the dissolution rate parallel to the (110) face and increase it perpendicular to this face. This resulted in agent (2), which was composed of 300 ml (1), 1 g Zn, 0.5 g  $\text{Na}_2\text{SO}_3$ , 1 g  $\text{Na}_2\text{B}_4\text{O}_7 \cdot 10\text{H}_2\text{O}$ , 0.1 g  $(\text{C}_7\text{H}_9\text{ON})_2 \cdot \text{H}_2\text{SO}_4$ , and 0.25 g  $\text{C}_6\text{H}_4(\text{OH})_2$ ; etching time 20 - 30 min.

Card 1/2

Selective etching of magnetic garnet ...

S/181/63/005/001/050/064  
B108/B180

The etch pits had rhombic bases with their sides parallel to those of the rhombododecahedral faces. The pits were arranged randomly or in lines. The main role in the agents described is played by the  $\text{Fe}^{3+}$ ,  $\text{Zn}^{2+}$ , and  $\text{Na}^+$  ions since their ionic radii are close to those of  $\text{Gd}^{3+}$ ,  $\text{Dy}^{3+}$ , and  $\text{Y}^{3+}$ . There is 1 figure.

ASSOCIATION: Institut neorganicheskoy khimii SO AN SSSR, Novosibirsk  
(Institute of Inorganic Chemistry of SO, AS USSR,  
Novosibirsk)

SUBMITTED: August 2, 1962

Card 2/2



KLEVTSOV, P. V.; ZAMOZHSKIY, V. D.

Selective etching of magnetic garnet crystals. Fiz. tver. tela  
5 no.1:339-340 Ja '63. (MIRA 16:1)

1. Institut neorganicheskoy khimii Sibirskogo otdeleniya AN  
SSSR, Novosibirsk.

(Garnet crystals--Magnetic properties)

ACC NR: AR6023282 SOURCE CODE: UR/0058/66/000/003/E039/E039

47  
B

AUTHOR: Zamozhskiy, V. D. ; Klevtsov, P. V.

ORG: none

TITLE: Nature of interlacing spirals of growth on crystals of ferrite garnet, yttrium, and rare-earth elements

SOURCE: Ref. zh. Fizika, Abs. 3E298

REF SOURCE: Sb. Simpozium, Protsessy sinteza i rosta kristallov plenok poluprovodnik. materialov, 1965. Tezisy dokl. Novosibirsk, 1965, 12

TOPIC TAGS: ferrite, garnet, yttrium, crystal surface, crystal growth, rare earth element

ABSTRACT: A spiral-laminar mechanism under hydrothermal conditions is shown by investigating the surface structure of crystal faces. Spirals on the crystal faces {110}, generated by growth centers on the screw dislocations, are characterized by an interlacing. This interlacing is controlled by the crystal structure of the garnet. [Translation of abstract]

[NT]

SUB CODE: 20/

Card 1/1 *da*

L 47329-66 EWT(1)/EWT(m)/T/EWP(t)/ETI IJP(c) GG/JG/JD

ACC NR: AR6025765

SOURCE CODE: UR/0058/66/000/004/A077/A077

AUTHOR: Klevtsov, P. V.; Zamozhskiy, V. D.

38  
B

TITLE: Influence of conditions of hydrothermal synthesis of iron garnet crystals of yttrium and of rare-earth elements on the formation of crystal-lattice defects

SOURCE: Ref. zh. Fizika, Abs. 4A648

REF. SOURCE: Sb. Simpozium. Protsessy sinteza i rosta kristallov i plenok poluprovodnik. materialov, 1965. Tezisy dokl. Novosibirsk, 1965, 12-13

TOPIC TAGS: yttrium iron garnet, rare earth element, garnet, hydrothermal synthesis, single crystal growing, crystal dislocation phenomenon, crystal defect

ABSTRACT: <sup>6</sup>Single crystals of iron garnets were synthesized in solutions of FeCl<sub>3</sub> and FeCl<sub>2</sub> at temperatures up to 600C the dislocations in the crystals were displayed by chemical etching. An increase in the synthesis temperature increases the number of defects in the crystals. In crystals obtained in FeCl<sub>2</sub> solutions, the dislocation density is higher. The causes of the increased dislocation density in this case are discussed. [Translation of abstract].

SUB CODE: 20

Card 1/1 pb

KOZOUSKOVA, J.; ZAMPACH, A.

Contribution to sanitary investigations of working conditions in spas with special attention to moulds causing mycoses. Pracovni lek. 12 no.7:355-357 S '60.

1. Hygienicky a epidemiologicky ustav lekarske fakulty v Brne, prednosta doc. MUDr. RMDr. K.Halacka.

(HEALTH RESORTS)  
(MYCOSES transm.)  
(INDUSTRIAL MEDICINE)

ZAMPACH, F.

"Economical construction of a saw-tooth roof composed of glued boards and prismatic elements."

p. 200((Stavba) Vol. 4, no. 7, July 1957  
Prague, Czechoslovakia

SO: Monthly Index of East European Accessions (EEAI) LC. Vol. 7, no. 4,  
April 1958

ZAMPACH, FRANTISEK,

Desulfuration of Thiokol DA, Fragitok Zampach and  
 Dusan Ambras. *Ckem. prirnysi 7, 123-01 (1967)*.—By  
 removing sulfur from polytetrasulfide rubbers, their  
 mech. properties after vulcanization are improved. NaOH  
 and Na<sub>2</sub>S were tested as desulfurizing agents and their effec-  
 tiveness was compared. Na<sub>2</sub>S was found preferable to  
 NaOH. When heating the thiokol latex 1 hr. at 80° with  
 an equimolar amt. of Na<sub>2</sub>S, a complete removal of free S  
 atoms from the chain was attained. The NaOH is sub-  
 stantially less effective and must be employed in excess.  
 L. A. Hejlich

2 May  
 HE 2c (7)

0 A 6

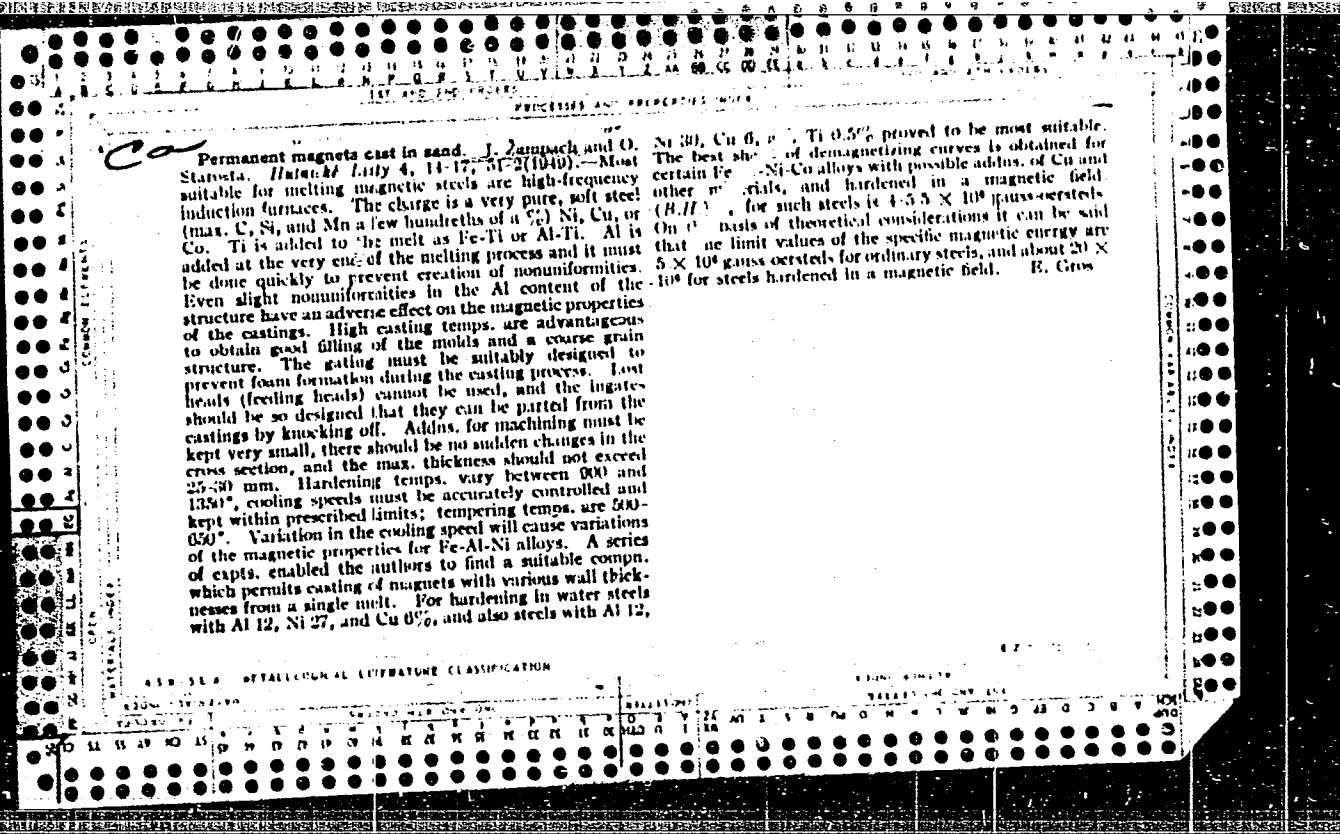

ZAMPACH, Josef

Exothermic facing from the mixture of CT. Slevarenstvi  
10 no.5:188 My '62.

1. Metalurgicke zavody, Tynec nad Sazavou.



9

*CA*

The dimensional stability of pistons cast from aluminum alloys. J. Zampach and O. Starosta. *Hutnicki Listy* 2, 7-9(1947). Aluminum alloys contg. 11.5-13 Si, 0.8-1.1 Cu, 0.8-1.3 Mg, 0.8-1.1 Ni, and a content of Fe + Ti not exceeding 0.8% did not change their dimensions more than 0.04% when heated to 250° for 6 hrs. The increase in vol. produced by the heating is due to a release of mol. strain, microstructural changes, alterations occurring in solid solns., etc. Repeated heatings and coolings of the castings did not produce any addtl. changes in the vol. When the pistons are used at a const. temp. or at a temp. lower than that at which the aging of the alloy occurred, they do not change vol. Frank Marsh

ASME-SLA METALLURGICAL LITERATURE CLASSIFICATION

1947

11 12 13 14 15 16 17 18 19 20 21 22 23 24 25 26 27 28 29 30 31 32 33 34 35 36 37 38 39 40 41 42 43 44 45 46 47 48 49 50 51 52 53 54 55 56 57 58 59 60 61 62 63 64 65 66 67 68 69 70 71 72 73 74 75 76 77 78 79 80 81 82 83 84 85 86 87 88 89 90 91 92 93 94 95 96 97 98 99 100

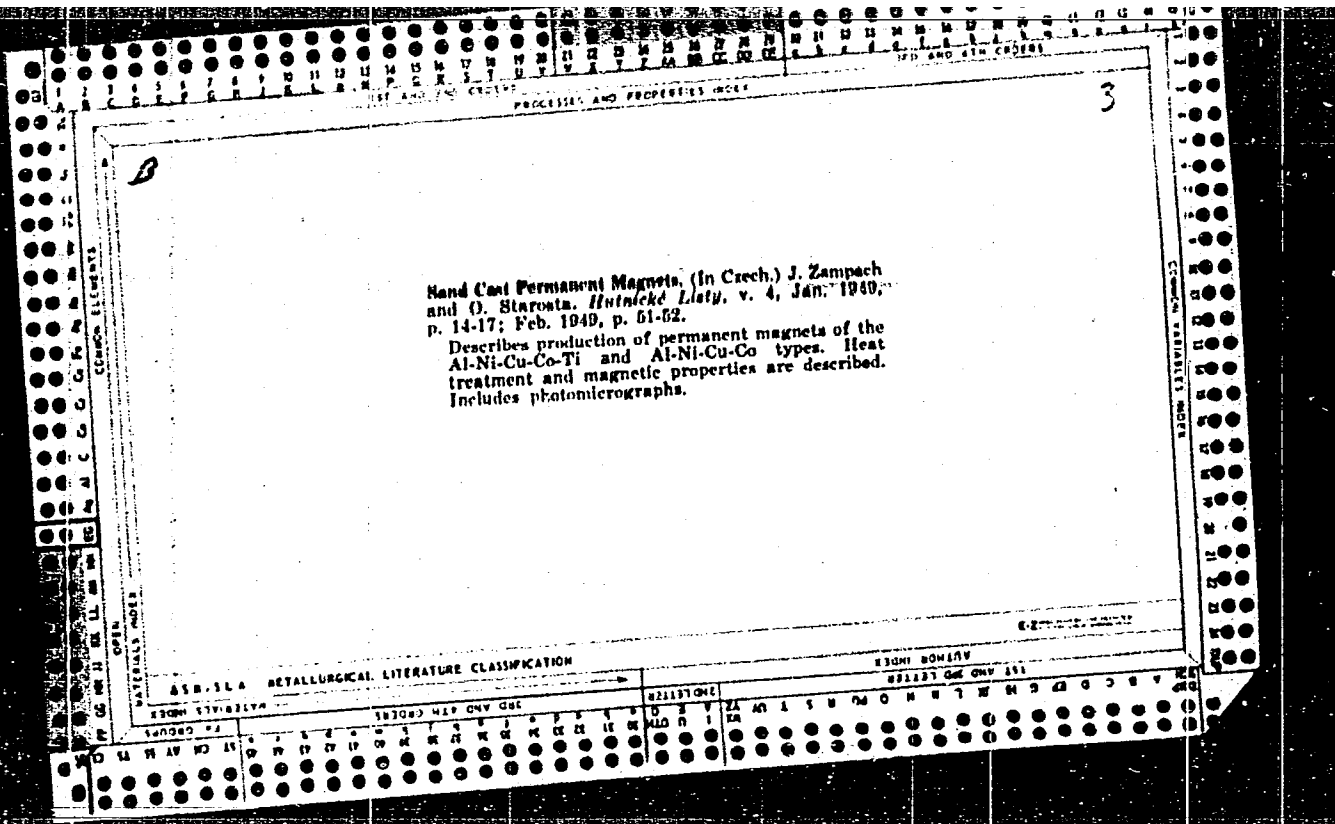

X ZAMPACH, J. and  
STAROSTA, O.

C. A. Vol. 42, January 10 - May 10, 1948  
2219 h

"The Dimensional Stability of Pistons Cast From Aluminum Alloys".  
J. Zampach and O. Starosta. Hutnicke Listy 2, 7-9 (1947), -

Aluminum alloys contg. 11.5-13 Si, 0.8-1.1 Cu, 0.8-1.3 Mg, 0.8-1.1 Ni, and a content of Fe + Ti not exceeding 0.2% did not change their dimensions more than 0.04% when heated to 250° for 6 hrs. The increase in vol. produced by the heating is due to a release of mol. strain, microstructural changes, alterations occurring in solid solns., etc. Repeated heatings and coolings of the castings did not produce any addnl. changes in the vol. When the pistons are used at a const. temp. or at a temp. lower than that at which the aging of the alloy occurred, they do not change vol.

ZAMPACH, J.

ZAMPACH, J. and  
STAROSTA, O.

C. A. Vol. 42, January 10 - May 10, 1948  
2219 h

"The Dimensional Stability of Pistons Cast From Aluminum Alloys".  
J. Zampach and O. Starosta. Hutnické Listy 2, 7-9 (1947), -

Aluminum alloys contg. 11.5-13 Si, 0.8-1.1 Cu, 0.8-1.3 Mg, 0.8-1.1 Ni, and a content of Fe + Ti not exceeding 0.8% did not change their dimensions more than 0.04% when heated to 250° for 6 hrs. The increase in vol. produced by the heating is due to a release of mol. strain, microstructural changes, alterations occurring in solid solns., etc. Repeated heatings and coolings of the castings did not produce any addnl. changes in the vol. When the pistons are used at a const. temp. or at a temp. lower than that at which the aging of the alloy occurred, they do not change vol.

ZAMPACH, J.

ZAMPACH, J. and  
STAROSTA, O.

C. A. Vol. 42, January 10 - May 10, 1948  
2219 h

"The Dimensional Stability of Pistons Cast From Aluminum Alloys".  
J. Zampach and O. Starosta. Hutnicke Listy 2, 7-9 (1947),-

Aluminum alloys contg. 11.5-13 Si, 0.8-1.1 Cu, 0.8-1.3 Mg, 0.8-1.1 Ni, and a content of Fe + Ti not exceeding 0.8% did not change their dimensions more than 0.04% when heated to 250° for 6 hrs. The increase in vol. produced by the heating is due to a release of mol. strain, microstructural changes, alterations occurring in solid solns., etc. Repeated heatings and coolings of the castings did not produce any addnl. changes in the vol. When the pistons are used at a const. temp. or at a temp. lower than that at which the aging of the alloy occurred, they do not change vol.

ZAMPACH, J.  
F. Practice

metal

3

The High-Frequency Furnace in the Foundry. J. Mackievic  
and J. Zampach. (*Stavárenství*, 1953, 1, (1-2), 8-18). (In  
Czech). The advantages of high-frequency furnaces in foundry  
practice, the construction and principles underlying their  
operation, the choice of crucible material, and the manufacture  
of crucibles for melting steel for castings are discussed,  
and experience acquired in the making of permanent magnet  
steels, alloy steels, and non-ferrous metals are considered.

114 1/2 PAQs, 100-1  
Production of Steel

②  
3

**Steelmaking in the High-Frequency Furnace.** J. Mackievic and J. Zambach. (*Stavrenskis*, 1953, 1, (4), 90-95). [In Czech]. An account is given of the author's experiences in the use of the high-frequency furnace in the manufacture of cast iron, manganese steel, and other high and low alloy steels and non-ferrous alloys, supplemented by a critical survey of the literature. The direction of further developments in the design and use of these furnaces, and the improvement of the refractory linings are considered.—P. 7.

140-71. Ferrite magnety lito do pisku. (Sand Cast Permanent Magnets.) J. Zaspach and O. Starosta. <i>Hutnicke Listy</i> , v. 4, Jan. 1949, p. 14-17; Feb. 1949, p. 51-52. Production of permanent magnets of the Al-Ni-Cu-Co-Tl and Al-Ni-Cu-Co types. Heat treatment and magnetic properties.									
AER-51A METALLURGICAL LITERATURE CLASSIFICATION									
140-71-1000									
140-71-1000									



ZAMPACH, V.

Journal of Applied Chemistry  
April 1954  
Industrial Inorganic Chemistry

steelmaking in the high-frequency furnace. J. Mackivic and  
J. Zampach (*Siderarstvo*, 1953, 1, No. 4, 90-95; *J. Iron Steel*  
*Inst.*, 1954, 179, 107).—An account is given of the author's experi-  
ences in the use of high-frequency furnaces in the manufacture  
of cast iron, manganese steel, and other high and low alloy steels  
and non-ferrous alloys, supplemented by a critical survey of the  
literature. Probable developments in the design and use of the  
furnaces, and in the improvement of refractory linings are  
considered. R. B. CLARKE

ZAMPACHOVA, Ljuba

Solubilization of organic vapors under increased pressure. Chem prum  
12 no.8:406-412 Ag '62.

1. Kralovopolska strojirna, n.p., Brno.

ZAMPACHOVA, L.: POPELKA, J.: VILIM, O.

"An apparatus for estimating the liquid-vapor equilibrium at high pressures"

Chemicke Listy. Praha, Czechoslovakia. Vol. 53, No. 1, Jan 1959

Monthly list of East European Accessions (EEAI), LC, Vol. 8, No. 6, Jun 59, Unclas

COUNTRY : CZECHOSLOVAKIA  
CATEGORY : Laboratory Equipment. Apparatus, Their Theory,  
Construction and Application  
ABS. JOUR. : RZKhim., No. 1 1960, No. 961  
AUTHOR : Popelka, J.; Vilim, O.; Zampachova, L.  
INST. : -  
TITLE : Apparatus for Determination of Liquid-Vapor  
Equilibrium at High Pressures  
ORIG. PUB. : Chem. listy, 1959, 53, No 1, 22-23  
ABSTRACT : A device for the determination of liquid-vapor  
static equilibrium at high pressures is des-  
cribed. The errors caused by nonequipoherent  
evaporation of liquid when the selection of  
vapor phase samples is made, have been elimi-  
nated from the apparatus. The chamber of the  
apparatus is divided into three parts which,  
after equilibrium is attained, can be separa-  
ted by a valve so that the upper part will

CARD:

1/2

F-6

CZECHOSLOVAKIA/Atomic and Molecular Physics - Changes of Aggregate D  
State

Abs Jour : Ref Zhur Fizika, No 11, 1959, 24741

Author : Popelka, Jaroslav; Vilim, Otakar; Zampachova, Ljuba  
Inst : -  
Title : Instrument for the Determination of the Equilibrium  
Between Liquid and Vapor at High Pressures.

Orig Pub : Chem. listy., 1959, 53, No 1, 22-23

Abstract : No abstract.

Card 1/1

7 5

An apparatus for the estimation of liquid-vapor equilibrium at high pressures. Jaroslav Popelka, Otakar Váňa, and Ljuba Zampachová (Výzkumný ústav synth. kaučuku, ~~Botwavaov~~, Czech.). *Chem. listy* 53, 22-3 (1959).—A static app. for measuring liquid-vapor equil. at high pressures was designed. The autoclave has 3 chambers sepd. by a double stop valve and adapted for sampling, is surrounded by a heating jacket, and is fitted with 2 pivots for the rocking machine. M. Hudlický

ZAMPACHOVA, L.

"Heat insulation in laboratory rectifying columns."

p. 408 (Chemický Průmysl) Vol. 7, no. 8, Aug. 1957  
Prague, Czechoslovakia

SO: Monthly Index of East European Accessions (EEAI) LC. Vol. 7, no. 4,  
April 1958

ZAMPACHOVA, Ljuba

Measurement of solubility of organic vapors in liquids  
under increased pressure. Chem prum 12 no.3:136-138 Mr '62.

1. Vyzkumny ustav makromolekularni chemie, Brno; present  
working place: Kralovopolska strojirna, Brno.



06609

CZECH/8-53-1-5/20

**AUTHORS:** Popelka, Jaroslav, Vilím, Otakar and Žampachová, Ljuba  
**TITLE:** Instrument for Determining the Liquid-vapour Equilibrium  
at Elevated Pressures  
**PERIODICAL:** Chemické listy, 1959, Vol 53, Nr 1, pp 22 - 23

**ABSTRACT:** A static apparatus for measuring liquid-vapour equilibria at high pressures has been designed. The disturbance of the equilibrium conditions devising the sampling operation, which occurs in the usual type of bomb apparatus, is eliminated by subdividing the apparatus into two or three chambers which can be isolated by closing a double stop valve fitted on a single spindle, which prevents non-equilibrium evaporation. A sketch (line drawing) of the apparatus is shown in Figure 1. Acknowledgments are expressed to J. Šuba for assisting in the design of the instrument. There are 1 figure and 2 references, of which 1 is Czech and 1 English.

Card 1/2

06609

CZECH/8-53-1-5/20

Instrument for Determining the Liquid-vapour Equilibrium at Elevated Pressures

ASSOCIATIONS: Výzkumný ústav synthetického kaučuku, Gottwaldov  
(Synthetic Rubber Research Institute, Gottwald)  
Výzkumný ústav makromolekulární chemie, Brno  
(Research Institute for Macro-molecular Chemistry, Brno)

SUBMITTED: January 13, 1958

Card 2/2

DVORAK, V.; VILIMEK, I.; ZAMRAZIL, V.

Some data on the clinical picture of fat embolism. Acta chir.  
orthop. traum. Cech. 31 no.3:258-263 .Je '64.

1. Interni oddeleni (vedouci MUDr. A. Süss) a ortopedicke  
oddeleni (vedouci MUDr. J. Horak Obvodního ustavu narodního  
zdravi v Fisku.

Neurology

CZECHOSLOVAKIA

DVORAK, V.; ZAMRAZIL, V.; Internal Department, Okresni Institute of Public Health (Interni Oddeleni OUNZ), Pisok, Chief (Prod-nosta) Dr A. SUSS.

"Neurological Complications in Dissecting Aneurism of the Aorta."

Prague, Ceskoslovenska Neurologie, Vol 30, No 1, Jan 67, pp 14 - 18

Abstract [Authors' English summary modified]: Three cases of dissecting aneurism are described; in all neurological complications were observed, and clinical findings were confirmed at autopsy. In one of the cases histological changes in the spinal cord were found. The cause was an ischemic lesion of the nervous tissue resulting from compression of the arteries originating in the aorta in the region of the aneurism. Description of the 3 main clinical types of nervous disturbances in dissecting aneurism of the aorta is presented. 1 figure, 14 Western, 4 Czech, 1 USSR reference. (Manuscript received 13 Sep 65).

1/1

SOV/81-59-10-35624

Translation from: Referativnyy zhurnal. Khimiya, 1959, Nr 10, pp 312-313 (USSR)

AUTHOR: Zamrika, A.I.

TITLE: Burning of High-Alumina<sup>15</sup> Insulators in Tunnel Furnaces

PERIODICAL: Tr. Soveshchaniya po intensiv. raboty tunnel'n. pechey na z-dakh stroit. keramiki, 1956. Moscow, Gosstroyizdat, 1958, pp 91-93

ABSTRACT: For the first time in the Soviet Union the burning of uralite insulators (I) in tunnel furnaces (TF) for auxiliary plugs of automobiles and tractors has been introduced. The composition of the insulator mass and the technical characteristics of TF are given. The temperature curve of the burning condition is given. A TF for the burning of I operates without interruption for  $> 20$  months. The output of a TF is 30 million I per year. In 1960 it is planned to increase the capacity of a TF at the expense of extending the zone of burning and reducing the time of pushing the cars to 37.5 million I and 500 t of uralite balls per year which amounts to 210% of its rated capacity.

I. Mikhaylova

Card 1/1

L 39887-66 EWT(d)/FSS-2 GD-2

SOURCE CODE: UR/0106/65/000/006/0031/0041

ACC NR: AP6016672

AUTHOR: Purtov, L. P.; Zamriy, A. S.; Shapovalov, I. F. 215

ORG: none

TITLE: Characteristic of error distributions in telephone channels during discrete signal transmission 8

SOURCE: Elektrosvyaz', no. 6, 1965, 31-41

TOPIC TAGS: telephone, radio relay, signal distortion equipment

ABSTRACT: After outlining the procedures for communication channel testing, this comprehensive article discusses the faithfulness of discrete information transmission through telephone cable and stationary radio-relay channels; the error distributions in time, the distribution of error groups, the combination distortion probability distribution, and the distribution of the quantity of errors within distorted combinations. Results show that 1) errors are distributed and tend, as a rule, to appear in groups; 2) the average reception error probability is a variable quantity and cannot be used for a reliable estimate of the transmission methods and of the correcting codes; 3) within distorted combinations the errors in cables and radio-relay channels are distributed approximately in the same manner (in spite of different values for the combination distortion probabilities); 4) during the phase difference operation the prevalent number of errors is even; and 5) interventions by the operating personnel are one of the reasons for the decrease in

faithfulness of discrete information transmission. V. I. Shlyapoberskiy, V. Ye. Klinger, G. V. Simonova, S. O. Dzherayan, A. F. Zubritskaya, S. A. Kuz'mina,

V. G. Bulin, E. P. Perfil'yev, N. I. Vovchenko, Z. M. Pronina and I. M. Cherkasov also participated in the organization and carrying out the tests of the communication channels. Orig. art. has: 11 figures and 5 tables. [JPRS]

SUB CODE: 17 / SUBM DATE: 16Oct64 / ORIG BER: 621.391.833: 621.395.12

Card 1/1 A/S

ACCESSION NR: AP4034471

S/0243/64/000/004/0058/0061

AUTHOR: Vende, E. Yu.; Bel'kovich, V. I.; Zamriy, G. T.

TITLE: Autocompensatory device for recording enterogastric pH

SOURCE: Meditsinskaya promyshlennost' SSSR, no. 4, 1964, 58-61

TOPIC TAGS: pH recording device, continuous enterogastric pH recording, autocompensatory device/ 036M oxyhemograph

ABSTRACT: A device for continuous recording of pH in the stomach is based on a special attachment developed by the authors for the autocompensator amplifier circuit of a 036M oxyhemograph (see enclosures 01 and 02). The pH values are determined by the potential differences of the antimony and calomel electrodes in the animal stomach. The margin of error for pH readings in laboratory tests on experimental animals does not exceed 0.3 units for pH ranging from 1.0 to 9.0 and 0.5 units for pH ranging from 9.0 to 11.4. For more accurate readings, gastric lavage is recommended to prevent mucus envelopment of electrodes. Potential fluctuations caused by mechanical activity of the stomach can be reduced by the use of a ring-shaped

Card 1/4

ACCESSION NR: AP4034471

electrode to encircle the catheter. The advisability of eliminating potential fluctuations related to stomach motor activity requires further study. Though these latter fluctuations distort the pH curve, they provide certain additional data on functional activity of the stomach. In animals the catheter and pickup are introduced into the stomach through a fistula. In humans the possibility of introduction per os has been demonstrated by the work of Ye. Yu. Linar. The new method of continuous pH recording in the stomach is greatly superior to the old method of taking samples of gastric contents. Orig. art. has: 3 figures and 1 table.

ASSOCIATION: Institut pitaniya AMN SSSR, Vsesoyuznyy nauchno-issledovatel'skiy institut meditsinskikh instrumentov i oborudovaniya, Moscow (Nutrition Institute AMN SSR, All-Union Scientific-Research Institute of Medical Instruments and Equipment)

SUBMITTED: 07Jan64

ENCL: 02

SUB CODE: LS

NR REF SOV: 001

OTHER: 004

Card 2/4



ACCESSION NR: AP4034471

ENCLOSURE: 01

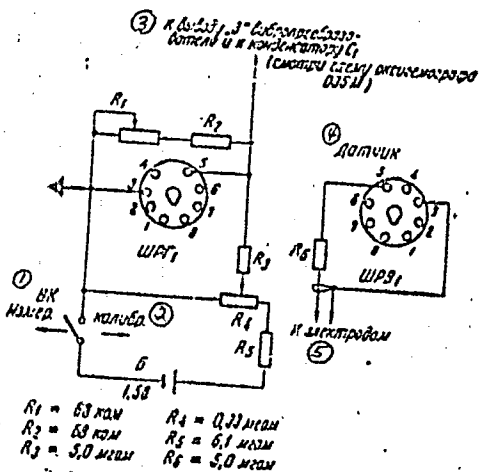

Fig. 1. Diagram of input circuit changes of 036M oxyhemograph when used to record enterogastric pH.

- (1) Measurement,
- (2) Calibration,
- (3) To load "3" of vibrotransducer and condenser  $C_1$  of 036M oxyhemograph,
- (4) Pickup,
- (5) To electrodes.

Card 1 3/4

ACCESSION NR: AP4034471

ENCLOSURE: 02

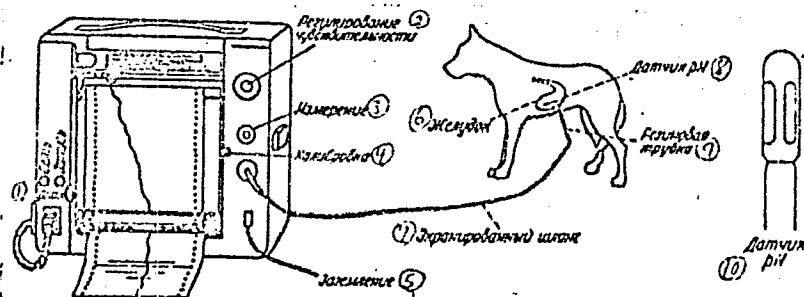

Fig. 2. General view of device, pickup, and system of connecting to dog through fistula.

- (1) Switch,
- (2) Sensitivity control,
- (3) Measurement,
- (4) Calibration,
- (5) Ground wire,
- (6) Stomach,
- (7) Shielded hose,
- (8) pH pickup,
- (9) Rubber tube,
- (10) pH pickup.

Card 4/4

86761

S/120/60/000/006/037/045

E041/E335

9.7500

AUTHORS: Zabiyakin, G.I. and Zamriy, V.N.

TITLE: Transistor Decade Counter

PERIODICAL: Pribory i tekhnika eksperimenta, 1960, No. 6,  
pp. 126 - 127

TEXT: The principle is that due to E.L. Kemp (Ref. 1). Pulses from the output of the first trigger pass through a control circuit either to the input of the second or the input of the fourth trigger, depending on the state of the control circuit. In the circuit of Fig. 1 the control gate uses the ultra-reliable diode-transformer arrangement. Saturated triggers are used with transistors of the П13 (P13), П14 (P14) and П15 (P15) type. All resistors are of the 10% tolerance class. The transformers are wound on two 7 mm diameter oxifer-1000 rings with 0.1 mm dia wire. Tr<sub>1</sub> and Tr<sub>2</sub> have 40:25 turns. Tr<sub>3</sub> has 40:40 turns. All the diodes are Д1В (D1V) and Д2В (D2V). The circuit of Fig. 1 is based on П16 (P16) and P15 transistors with emitter-follower buffer stages. The Card 1/4

86761

S/120/60/000/006/037/045  
E041/E335

Transistor Decade Counter

resolving time is  $2.5 \mu\text{s}$ . Maximum counting rate is more than 300 kc/s. For an  $0.3 \mu\text{s}$  input pulse the amplitude may vary  $\pm 40\%$  about 5 V. The operation has been proved over the temperature range  $+16$  to  $+52^\circ\text{C}$ . Such counters have been incorporated in a self-contained instrument by adding before them a shaping circuit to accept pulses of either polarity ( $2 - 12 \text{ V}$ ,  $> 0.1 \mu\text{s}$ ) and after them a mechanical counter, type  $\text{C}\bar{5}\text{-jM}$  (SB-1M). The capacity is  $10^5$ , the power

consumption 10 VA, dimensions  $120 \times 180 \times 185 \text{ mm}$ , weight 4 kg. Substitution of the drift transistor  $\square 401$  (P401) in the first stage improves the resolving power to a few tenths of a  $\mu\text{s}$ . B.N. Kononova is thanked for his interest in the work.

Card 2/4

86761

S/120/60/000/006/037/045  
E041/E335

Transistor Decade Counter

There are 1 figure and 4 references: 3 Soviet and  
1 non-Soviet.

ASSOCIATION: Ob'yedinennyy institut yadernykh issledovaniy  
(Joint Institute for Nuclear Research)

Card 3/4

86761

S/120/60/000/006/037/045  
E041/E335

Transistor Decade Counter



Рис. 1. Схема пересчетной декады.  
SUBMITTED: September 30, 1959  
Card 4/4

ACCESSION NR: AR4032156

S/0058/64/000/002/A017/A017

SOURCE: Ref. zh. Fiz., Abs. 2A180

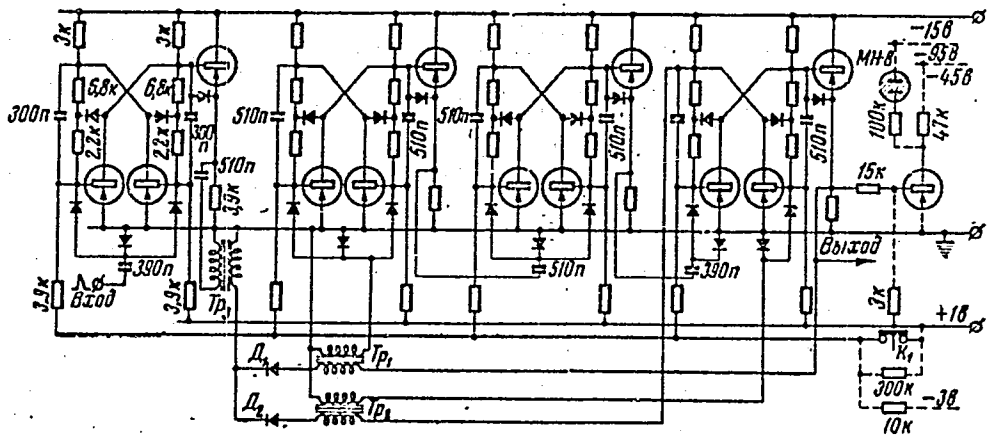
AUTHORS: Dorofeyev, V. A.; Zabiyaikin, G. I.; Zamriy, V. N.; Markomenko, V. I.; Semashko, V. I.; Tulayev, B. P.; Cherny\*y, A. V.; Shibayev, V. D.

TITLE: Automatization of the reduction of measurement results

CITED SOURCE: Tr. 5-y Nauchno-tekhn. konferentsii po yadern. radioelektron. T. 4. M., Gosatomizdat, 1963, 7-14

TOPIC TAGS: measurement results, data reduction, computer data reduction, computer data insertion, computer memory, direct coupling data insertion, rigid coupling free coupling

TRANSLATION: Problems are discussed involved in the automatization of the reduction of the experimental data obtained in multichannel

Card 1/3

ACCESSION NR: AR4032156

analyzers, multimeter systems (hodoscopes), and bubble chambers. It is concluded that it is most sensible to employ for this purpose the existing universal digital computers, capable of solving all mathematical problems. The most rational method of inserting the information is by direct coupling. An analysis based on estimates of the insertion of information into different units of a universal computer is shown that a system in which a large number of experimental data are inserted into the magnetic memory of the computer is among the most advantageous. Two possible coupling variants are considered: "rigid" coupling, when the information is inserted into the memory with the aid of the electronic units of the computer, and "free" coupling, when the information insertion does not depend on the state of the computer, but additional electronic apparatus is used for this purpose. The most promising and advantageous is the "free" coupling. The information is recorded on magnetic tape in this case in the form selected for the given type of computer. This makes it possible to accumulate the experimental data over a

Card 2/3

ACCESSION NR: AR4032156

long time without tying up the computer at the same time, and to process the experimental data without any insertion operations, by direct access to the magnetic memory. Specific features of automated insertion of experimental data into a computer are discussed.  
L. I.

DATE ACQ: 31Mar64

SUB CODE: CP, SD

ENCL: 00

Card 3/3



ACCESSION NR: AR4020787

S/0271/64/000/002/B046/B046

SOURCE: RZh. Avtomat., telemekh. vy\*chislitel. tekhnika, Abs. 2B291

AUTHOR: Zamriy, V. N.

TITLE: Certain methods of converting binary digital information into decimal form.

CITED SOURCE: Tr. 5-y Nauchno-tekhn. konferentsii po yadern. radio-elektron.  
T. 4. M., Gosatomizdat, 1963, 64-72

TOPIC TAGS: binary-to-digital conversion, multichannel analyzer, weighted pulse,  
pulse counter, pulse counting, binary counter, decimal counter

TRANSLATION: The design of a system is examined for converting binary coded data stored in the memory of a multichannel analyzer into decimal numbers convenient for printing out experimental results. Several modifications of the counting method are described whereby the binary register is supplemented with pulses from a separate oscillator and the pulses are counted simultaneously by a decimal counter. The modified counting methods provide for supplying different weights to the pulses, which accelerates the conversion. Circuits are examined

Card 1/2

ACCESSION NR: AR4020787

in detail for constructing the conversions by the method of adding weights whereby through sequential interrogation of the binary counter cells the quantitative characteristic of the binary places in which ones are stored are worked out directly into decimal form. The schematic circuits are shown of the interrogation unit, conversion matrix, and of the pulse generator included in the converter circuit which provides pulses to the output decimal counter decades. Orig. art. has 5 figs. and 3 refs. I. V.

DATE ACQ: 03Mar64

SUB CODE: SD, CP

ENCL: 00

Card 2/2

ACCESSION NR: AR4032158

S/0058/64/000/002/A017/A018

SOURCE: Ref. zh. Fiz., Nos. 2A182

AUTHOR: Zamriy, V. N.

TITLE: Address counter with short carry time

CITED SOURCE: Tr. 5-y Nauchno-tekhn. konferentsii po yadern. radioelektronike. T. 2. Ch. 1. M., Gosatomizdat, 1963, 162-165

TOPIC TAGS: address counter, binary address scaler, short carry time, group carry circuit, accelerated group carry circuit, delayed controlled triggering, accelerated carry counter

TRANSLATION: A binary address scaler circuit (SC) is described. Its advantage is a short carry time (short delay of the signal when transferred from one flipflop cell to another and to the output of the SC), accomplished by having the input pulse pass through gates

Card 1/3

ACCESSION NR: AR4032158

that are set beforehand by the preceding pulse. The flipflop cell of the counter is controlled by two diode-transformer rectifiers. When the input pulse arrives at the output of the conducting rectifier, two pulses of opposite polarity appear, corresponding to the leading and trailing fronts of the input pulse. The second pulse (of positive polarity) is used to trigger the flipflop. The resultant time delay ensures positive operation of the flipflop. The first pulse (of negative polarity) is applied to the input of the next cell if the flipflop is in the "1" state prior to this. Thus, the carry pulse is applied to the input of the next cell prior to the clearing of the preceding flipflop. The carry time from cell to cell is 0.03  $\mu$ sec, and for a counter consisting of ten cells it amounts to 0.3  $\mu$ sec, while the time for resetting the state of the last flipflop is 0.5  $\mu$ sec. An accelerated group carry circuit is also proposed. The counter is broken up into two groups each with five flipflop cells. The voltages from the outputs of the first five cells are applied to the inputs of a coincidence circuit which

Card 2/3

ACCESSION NR: AR4032158

controls the rectifier that transmits directly the input signal to the next group of flipflops. The carry time in the counter is then less than 0.2  $\mu$ sec, and the time for establishment of the output voltage of the cells is 0.35--0.4  $\mu$ sec. The following are given: diagram of the flipflop cell with delayed controlled triggering, block diagram of the counter with accelerated carry, and diagram of the group carry circuit. The flipflop cell uses P402 transistors and D2A diodes. The minimum amplitude of the triggering pulses is 3 V at a duration of 0.1 millisecond. The duration of the front of the output pulse is 0.1  $\mu$ sec. The permissible variation in the supply voltage is  $\pm 30\%$ . The counting rate of the SC ranges up to 2 Mc/sec. M. Vishnevskiy.

DATE ACQ: 31Mar64

SUB CODE: CP, GE

ENCL: 00

Card 3/3

ACC NR: AR6033988 SOURCE CODE: UR/0271/66/000/008/B043/B043

AUTHOR: Zabiyakin, G. I.; Zamriy, V. N.

TITLE: Device for transferring experimental information to a computer

SOURCE: Ref. zh. Avtomatika, telemekhanika i vychislitel'naya tekhnika, Abs. 8B320

REF SOURCE: Tr. 6-y Nauchno-tekhn. konferentsii po yadern. radioelektron. T. 3. Ch. 1. M., Atomizdat, 1965, 100-109

TOPIC TAGS: computer, multichannel analyzer, data recording, computer storage device, data sampling

ABSTRACT: A transmitting device which makes it possible to retrieve measurement results from multichannel analyzers and to transmit them directly to the computer reception unit which ensures autonomous data recording in one of the computer storage devices, is described. The device converts input information into a form convenient for transfer and input into the reception unit. It controls transmission by turning the reception unit on and off. The analyzer interrogation realized by means of pulses from the device takes place at a speed set by the

Card 1/2

UDC: 681.142.624

ACC NR: AR6033988

reception (storage) unit of the computer which excludes time mismatch. Addition of the transmitted data is provided for in order to control the operation of the system. Following data sampling in all the assigned analyzer channels, the control sum is transmitted to the reception unit for comparison. When the control sum is not in agreement, the sampling is repeated. Information is transmitted in the form of a pulse train over a communication line over 7 km long. Three illustrations. Bibliography of 4 titles. [Translation of abstract]

SUB CODE: 09/

Card 2/2

ACC NR: AR7004323

SOURCE CODE: UR/0271/66/000/011/B034/B034

AUTHOR: Vladimirov, V. A.; Zamriy, V. N.

TITLE: Recording on punchtape and checking the experimental data

SOURCE: Ref. zh. Avtomat. telemekh. i vychisl. tekhn., Abs. 11B264

REF SOURCE: Tr. 6-y Nauchno-tekhn. konferentsii po yadern. radioelektron. T. 3. Ch. 2. Atomizdat, 1965, 29-35

TOPIC TAGS: ~~multichannel~~ analyzer, ~~data processing~~ punched paper tape, computer out-put unit.

ABSTRACT: A method of checking the data recorded on punchtape is described which compares check totals. The check total is obtained from an adder to which data is fed from a recording system. In tape recording, the incoming-signal codes are converted into mechanical motions and perforation characters which also are counted. Tallying the total on the tape with the check total testifies to the correctness of data read-out and recording. The check system comprises a tape punching device, a readout device and a check adder. With a 6-track recording and a perforation rate of 20 lines per second, 200 16-digit numbers or 100 48-digit numbers can be processed in one minute. The adder is of the end-around-carry design. The adder input is connected to the multichannel-analyzer output. The interrogation time of 1000 channels is one second. The total readout time of 1000 channels is 6 minutes. The above efficient method was developed in the Laboratory of Neutron Physics, Joint Institute of Nuclear Studies. Two figures. Bibliography of 2 titles. V. L. [Translation of abstract].

SUB CODE: 09, 18

Card 1/1

FD-302 (Rev. 1-10-60)



ZHUKOV, G.P.; ZIKHEVLEV, B.Ye.; ZABIYAKIN, G.I.; ZAMRIY, V.N.

Center for neutron spectrometry. Prib. i tekh. eksp. 9 no.6:  
34-38 N-D '64. (MERA 18:3)

1. Ob"yedinennyy institut yadornykh issledovaniy.

AUTHOR: Zamriy, V. N.

TITLE: Device for converting binary-decimal code into binary. Class 42,  
No. 170210

... a device for converting binary-decimal  
... circuit through a gate whose output is  
digit of the leading tetrad (see Fig. 1 on the Enclosure). The gate output is  
connected to the inputs of gates for recording the converted code, which are  
connected to the decoder of the three leading tetrad digits. Orig. art. has 1  
diagram.

NO REF SOVI 000  
Card 1/2

BT CODE: DP

ENCLOSURE 01

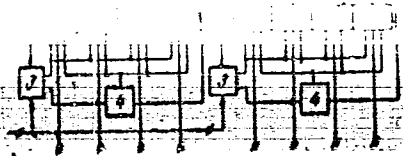

... tetrad; 2- decoder;  
... register gates

ZABIYAKIN, G.I.; ZAMRIY, V.N.; SEMASHKO, V.I.

Automatic system for transmitting information from multiple-wave analyzers to a computer. Prib. i tekh. eksp. 9 no.4: 139-143 J1-Ag '64. (MIRA 17:12)

1. Ob"yedinennyy institut yadernykh issledovaniy.

AUTHOR: Zhukov, G. P.; Zhuravlev, B. Ye.; Zabiyakin, G. I.;  
Zamry, V. N.

14  
4  
D

... spectrometric measurements ...

... 1984, 34-38

... fast reactor, fast reactor

ABSTRACT: The structure of a new "Center" of neutron-spectrometric measurements at the Neutron-Physics Laboratory, OIYaI, is briefly described. The Center takes into account the specific features of spectrometric work on the ... regarding equipment, around-  
the-clock measurements, ... independent  
... the computer

ADDITIONAL NP AP5012 43

3

...the tens of thousands. A magnetic tape storing device is used. A provision is made for delaying the ... with different widths in ... channel groups with different widths in ... the slowest of ...

ASSOCIATION: Ob'yedirennyy institut yadernykh issledovaniy (Joint Nuclear Research Institute)

SUBMITTED: 02Dec63

ENCL: 00

SUB CODE: NP

I. 19601-65 ЭЭТ(д)/БЕС(к)-2/БЕД-2/БМП(1) Рг-1/Рк-1/Рм-1/Ро-1/Рс-1/ ИП(с)/  
(с) / РАМ(а) / АРМ(б) /

AUTHOR: Zabiyakin, G. I. ЗАБИЯКИН, Г. И.  
... transmission from multichannel

TOPIC TAGS: pulse light analyzer, multichannel analyzer, automatic control system, computer data processing -160

ABSTRACT: An automatic system for transferring information from a multi-channel analyzer (over 1 000 channels) to the external storage of a computer located at a distance of 1.5 km is briefly described. The system (see Enclosure 1) takes experimental data channel-by-channel from the analyzer, sends it over two coaxial cables, and records it on magnetic tape in one of the external storages, the latter is controlled by the experimenter and operates independently

... 1/3

1. 17001-7  
ACCESSION NR: AP4044685

of the computer. A 16-binary-digit code is used. Code pulses are sent every 4  
of the computer. A 16-binary-digit code is used. Code pulses are sent every 4  
of the computer. A 16-binary-digit code is used. Code pulses are sent every 4

ASSOCIATION: Ob'yedinennyy institut yadernykh issledovaniy (Joint Nuclear  
Research Institute)

SUBMITTED: 20Jul63

ENCL: 01

SUB CODE: HF

NO REF SOV: 005

OTHER: 002

Card 2/3



L 19601-65

ACCESSION NR: AP4044685

ENCLOSURE 01  
0

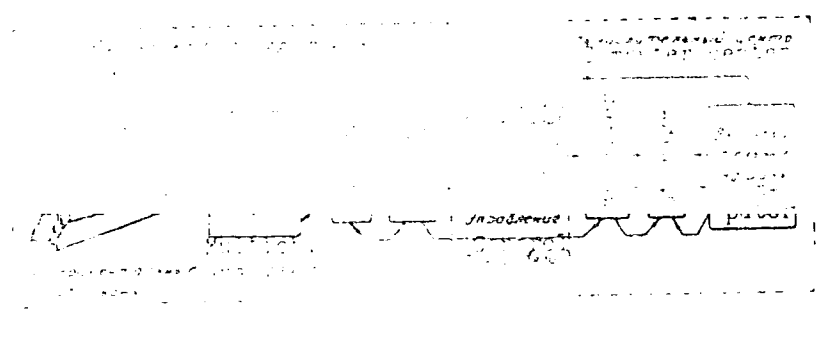

An automatic system for transmitting experimental data from a multichannel analyzer to a computer

Card 3/3

ZAMRZLA, E.

CZECHOSLOVAKIA/Chemical Technology. Chemical Products. Water  
Treating. Sewer Water

H-5

Abs Jour : Ref Zhur - Khimiya, 1958, No 22, 74436

Author : Zamrzla E.

Inst : Not Given

Title : Treatment of Sewer Water Effluent from Metallurgical Plants

Orig Pub : Hutnicko listy, 1958, 13, No 2, 133-140

Abstract : Characteristics of the effluent sewer water streams originating in different sections of metallurgical plants (including the fuel gasification) are presented. The use of water recycling is highly recommended.

Card : 1/1

ZAMRZIA, E. inz.

Observations on V. Masek's article "Effect of sulfite calcination  
waste on concrete and steel." Vodni hosp 14 no.6:232 '64.

QA

3

Apparatus for the study of the diffraction of slow electrons at different temperatures. S. G. Kalashnikov. *J. Appl. Phys.* (U. S. S. R.) 9, 1405-7(1939).  
 K. describes an app. for the complete study of the space distribution of scattered electrons for various temps. of the scattering crystal from 500 to 900°K. The max. deviation from the mean intensity does not exceed 5%. Influence of the temperature on the diffraction of slow electrons from a silver mono-crystal. S. G. Kalashnikov and O. I. Zaytseva. *Ibid.* 1408-14(1939).--From measurements on the intensity of the various beams of slow electrons diffracted from the (001) face of monocrystalline Ag at various temps. from 290 to 940°K., K. and Z. find that the thermal oscillations causing the scattering are anisotropic. The equiv. internal potentials for the beams are, resp.: (004), 10 e. v.; (008), 9.5; (008), 13; and (016), 9 e. v. The mean vibrational shift is  $(\bar{u}^2)^{1/2} = 0.152 \text{ \AA}$ . at 800°K.; the lateral oscillation is greater than the vertical. The

1 diffraction of slow electrons cannot be treated geometric volume effect. P. 11

ASTM 11 METALLOGICAL LITERATURE CLASSIFICATION

ZAMSHA, O.I.; PLOTHIKOV, Yu.I.

Cutting crystals with a paper disk. Prib. i tekhn. eksp. no. 2:159  
Mr-Ap '60. (MIRA 13:7)

1. Moskovskiy inzhenerno-fizicheskiy institut.  
(Cutting machines)

S/120/60/000/02/048/052

AUTHORS: Zamsha, O.I. and Poltnikov, Yu.I.  
E140/E335

TITLE: Cutting Crystals with Paper Discs

PERIODICAL: Pribery i tekhnika eksperimenta, 1960, No 2,  
p. 159 (USSR)

ABSTRACT: Organic crystals are cut by paper discs, 150 mm in diameter, 4500 rpm. Motor power has to be adequate to maintain good speed regulation or else the crystal crumbles.

ASSOCIATION: Moskovskiy inzhenerno-fizicheskiy institut  
(Moscow Engineering-physics Institute)

SUBMITTED: February 25, 1959

Card 1/1

ZANSHA, C. I.

Mbr., Lab. Molecular and Thermal Phenomena, Sci. Res. Inst. Physics, Moscow

Order Lenin State Univ. im. M. U. Lomonosov, -1939-.

"Influence of the Temperature on the Diffraction of Slow Electrons from a Silver Single-Crystal," Zhur. Eksper. i Teoret Fiz., 9, No. 12, 1939.

Mbr., Lab. Molecular and Thermal Phenomena, Sci. Res. Inst. Physics, Moscow Order

Lenin State Univ., im. M. U. Lomonosov, -1939-.

KROT, I.P., red.; ZAMSHEV, V.I., otvetstv. za vypusk; PETUKHOV, P.I.,  
tekhn. red.

[Economy of Vologda Province; statistical collection] Narodnoe kho-  
ziaistvo Vologodskoi oblasti; statisticheskii sbornik. Vologda,  
Gos. stat. izd-vo, 1960. 132 p. (MIRA 14:6)

1. Vologda(Province)Statisticheskoye upravleniye. 2. ~~Nauchal'nik~~  
statisticheskogo upravleniya Vologodskoy oblasti (for Krot)  
(Vologda Province—Statistics)



KUZ'MINA, L.M.; ZAMSKAYA, I.A.

Work practice of the grading room staff striving for the  
title of a section of communist labor. Khim. volok. no.6:60-  
61 '60. (MIRA 13:12)

1. Mogilevskiy zavod.  
(Mogilev--Textile fibers, Synthetic)

ZAMSKIY, S.I. [deceased]

Feeding habits of gamasid mites *Eulaelaps stabularis* (C.L. Koch)  
and *Haemolaelaps glasgowi* (Ew.) inhabiting the burrows of murine  
rodents. Mat. k pozn. fauny i flory SSSR. Otd. zool. no.39:259-283  
'64. (MIRA 17:6)

ZAMSKIY, T.G., inzhener

Using brickwork blocks in the erection of TP-230 and TP-170  
boilers. Elek.sta.26 no.11:44-46 N'55. (MIRA 9:1)  
(Boilers)

ZAMSKIY, T. G.

V 4633. USE OF WALL BLOCKS IN ERECTION OF TP-230 AND TP-170 BOILERS.  
Zamskiy, T.G. (Elektr. Sta. (Rur Sta., Moscow), Nov. 1955, vol. 26, 44-46).  
Boiler erection time is considerably shortened by the use of wall blocks,  
while accuracy can be achieved by the substitution of refractory concrete for  
firebricks. The characteristics and location of the different sized blocks  
used in the erection of a boiler are indicated. Average cost per m<sup>3</sup> of  
refractory reinforced concrete is 300 roubles, against 650 roubles for firebricks.  
The use of refractory concrete instead of firebricks also reduces the number of  
skilled and semi-skilled personnel required. (L). C.E.A.

ZAMSKIY, T.G., inzhener.

New method of heat-insulation work. Elek.sta. 27 no.7:47  
J1 '56. (MLRA 9:10)

(Insulation (Heat)) (Boilers)

Zamskiy, T. G.

AID P - 4026

Subject : USSR/Power  
Card 1/1 Pub. 26 - 15/31  
Author : Zamskiy, T. G., Eng.  
Title : Using walling blocks while installing TP-230 and TP-170 boilers.  
Periodical : Elek. sta., 11, 44-46, N 1955  
Abstract : The author reports on the speed-up method of installing boilers and walls simultaneously as it was done at the construction of one of the new power plants in the Donbas area. The article explains the procedure in great detail. Insulated reinforced concrete blocks were used. Eight diagrams.  
Institution : None  
Submitted : No date

ZAMSKIY, T.G., inzh.

Induction heating of oil conductors. Elek. sta. 35 no.6:89  
Je '64. (MIRA 18:1)

ZAMSKIY, V. L.; KHOMYLEV, V. S.; DUBININ, V. A.

Reducing the silk winding density in the BP-12 bobbin winding machines. Khim. volok. no.6:52-53 '62. (MIRA 16:1)

(Winding machines)



16

1. 100-1-67 (1) (1)  
 100-1-67 (1) (1)

SOURCE CODE: UR/0413/66/000/015/0094/0094

AUTHORS: Vokhov, B. Ye.; Lokennikov, V. S.; Ayzman, Yu. A.; Sokolinskiy, Yu. A.;  
 Arkhiv, A. A.; Koplunov, A. I.; Fedorov, V. N.; Ivanov, A. M.; Malinskiy, S. A.;  
 Trubnikovskiy, V. V.; Anik, V. Kh.; Vysotskiy, Yu. A.; Zamakiy, V. M.; Bystrov, V. V.;  
 Korosov, V. P.; Stobudkin, I. V.; Yevzerov, D. A.; Germanov, Yu. G.; Maksimov, N. P.;  
 Shchepanov, L. A.; Plakshilin, V. V.

ORG: none

TITLS: Seismic station. Class 42, No. 184466 [announced by "Neftepribor" Factory  
 of the Instrument Manufacture Administration of Mosgorsovnarkhoz (Zavod "Neftepribor"  
 Upravleniya priborostroyeniya Mosgorsovnarkhoza)]

SOURCE: Izobret prom obraz tov zn, no. 15, 1966, 94

TOPIC TAGS: seismologic station, seismologic instrument

ABSTRACT: This Author Certificate presents a seismic station containing a seismic  
 signal detector, a recording amplifier unit, an oscillograph, a magnetic drum  
 recorder, a channel reproduction unit, a control unit, a reproduction amplifier, a  
 multichannel borehole probe, a drum with photographic paper, a retransmitting unit,  
 and a power supply. To increase the reliability when transferring from operation with  
 the method of reflected waves to the method of refracted waves, a filter unit is  
 connected between the first and second stages of the recording amplifier unit. 'A

UDC: 550.340:19

Cord 1/2

E 16061-57

ACC NR: AP6029933

modulator-demodulator unit and a reel type magnetic recorder are connected in series to the output of the recording amplifier unit. For operation with the method of refracted waves, the filter unit has frequency cutoffs of 7--30 hz, and for operation at sea--frequency cutoffs of 20--50 hz. To increase the reliability of the recorded data with operation by the method of regulated directional reception, a switching unit for the channels to be summed, a static correction unit, and a summing unit are connected in series between the magnetic drum recorder and the reproduction amplifier. To increase the reliability when transferring from operation with the method of reflected waves to seismic logging, a frequency selection unit is connected between the multichannel borehole probe and the magnetic drum recorder. To improve the quality of the recorded material, an electron beam unit for introducing static and dynamic corrections is connected between the reproduction amplifier and the drum with photographic paper.

SUB CODE: 00/ SUBM DATE: 05May65

Card 2/2

MELIKADZE, I.G.; LARIN, R.R.; BEZHANOV, F. Kh.; Prinsipali uchastiye:  
KHUROSHVILI, G., inzh.; TSAGARELI, T., inzh.; ZAMTARADZE, E., inzh.;  
BOCHORISHVILI, G., teknik; MAYSURADZE, L., laborant; SHUBLADZE, G.,  
laborant; PANKRATOVA, Ye., kammerez.

investigation of teschenite disintegration by the thermal method.  
Soob. AN Gruz. SSR 34 no.3:633-640 Je '64 (MIRA 18:1)

1. Institut gornogo dela imeni G.A. TSulukidze AN Gruzinskoy SSR.  
Submitted November 25, 1963.

ZAMTARADZE, G.

Some little-known species of Mount Bol'shoy Abul [in Georgian  
with summary in Russian]. Zam.po sist.1 geog.rast. no.17:  
157-159 '53. (MLRA 8:9)  
(Bol'shoy Abul, Mount--Alpine flora)