

25X1

Approved For Release 2004/07/09 : CIA-RDP89B00980R000500100001-8

Approved For Release 2004/07/09 : CIA-RDP89B00980R000500100001-8

**TOP SECRET**

Approved For Release 2004/07/09 : CIA-RDP89B00980R000500100001-8

CORONA HISTORY

Volume IV



CORONA PROGRAM HISTORY

VOLUME IV

RECOVERY FROM ORBIT

19 May 1976

This volume consists of 70 pages.

Volume IV of V Volumes

Copy **7** of 12 Copies

**NRO review(s) completed.**



25X1

**TOP SECRET**

Approved For Release 2004/07/09 : CIA-RDP89B00980R000500100001-8



**TOP SECRET**

CORONA HISTORY  
Volume IV

PUBLICATION REVIEW

This report has been reviewed and is approved.



CORONA Project Officer  
Directorate of Science & Technology  
Central Intelligence Agency

25X1

**TOP SECRET**

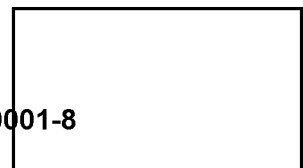

CORONA HISTORY  
Volume IV

TABLE OF CONTENTS

	Page
TITLE PAGE .....	i
PUBLICATION REVIEW .....	ii
TABLE OF CONTENTS .....	iii
DISTRIBUTION .....	iv
SECTION I - SATELLITE RECOVERY VEHICLE HISTORY AND DESIGN EVOLUTION .....	1-1
SECTION II - SATELLITE RECOVERY VEHICLE .....	2-1
SECTION III - RE-ENTRY AND RECOVERY OPERATIONS .....	3-1
SECTION IV - RE-ENTRY VEHICLE PERSONNEL AND DEVELOPMENTAL TESTING .....	4-1

25X1

**TOP SECRET**

**TOP SECRET**

Approved For Release 2004/07/09 : CIA-RDP89B00980R000500100001-8

CORONA HISTORY  
Volume IV

DISTRIBUTION

<u>Organization</u>	<u>For Attention of</u>	<u>Copy Number</u>	
NRO	- J. Plummer	2	
SAFSP	- Gen Kulpa	1	
CIA/S&T	- C. Duckett	1	
CIA/Archives	-	1	
CIA/OD&E	- L. Dirks	1	
CIA/Project Officer	- <input type="text"/>	2	25X1
NPIC	- J. Hicks	1	
ITEK	- <input type="text"/>	1	25X1
GE	- <input type="text"/>	1	
LMSC	- <input type="text"/>	1	

25X1

**TOP SECRET**

Approved For Release 2004/07/09 : CIA-RDP89B00980R000500100001-8

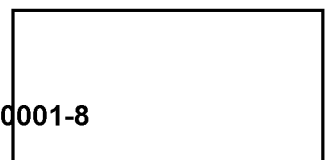

~~TOP SECRET~~

CORONA HISTORY  
Volume IV

SECTION I

SATELLITE RECOVERY VEHICLE HISTORY AND DESIGN EVOLUTION

In February 1958, the General Electric Company's Space Re-entry Program Division at Philadelphia, Pennsylvania, was chosen to design and produce a recoverable capsule for the CORONA Program. This was handled administratively under a subcontract to Lockheed Missile and Space Division. Concurrently, they were also given a contract to design and produce a capsule for the recovery of animals from outer space.

These animal capsules, called a MARK (MK) I for use in recovering mice and a MARK II for the recovery of primates, served a dual purpose. Their purpose was to gain re-entry information for the manned space program that would follow, and also to provide a cover story for CORONA. Figure 1-1 presents a picture of the MK I recovery capsule. The initial CORONA photographic recovery capsule was called MK IIA.

In April 1959, the first MK I was launched on DISCOVERER II with a planned recovery north of Hawaii. However, an incorrect timing sequence caused the capsule to be ejected over Norway. The interesting events that followed are described in Volume I. DISCOVERER III, with mice aboard, never achieved orbit. As a result of the outcry from the press all launching of biomedical specimens on this program was halted.

DISCOVERERS IV through XI were haunted by either failure of the satellite to orbit or failure to recover after orbit was achieved. As a result of these failures, especially DISCOVERER V, a series of intensive studies and tests were undertaken by Lockheed and General Electric. Some highlights of these efforts were:

- A. The orbital thermal balance was reevaluated; a series of added tests on the thermal properties performed; vehicle heat retention characteristics were improved; and heaters were added to key locations.
- B. The orbit ejection dynamics and atmospheric re-entry survival corridor, along with the changing orbital flight paths, were reevaluated and further tests were performed to confirm aerodynamic stability.
- C. Electrical power was studied for thermal effects, reliability, and useful life; electrical system and subsystem tests were performed; power supplies were increased for added safety; and changes were made to improve the reliability of electrical components and systems.
- D. Rocket test data were reevaluated; added tests were performed; and a series of design improvements were utilized.
- E. The major events that take place during the satellite recovery vehicle's flight through space were monitored through the addition of a lightweight telemetry system.

25X1

~~TOP SECRET~~

**TOP SECRET**

CORONA HISTORY  
Volume IV

THE MK I RECOVERY CAPSULE



Ingar Clausen, GE's First DISCOVERER Program Manager, Showing the Mark I Capsule  
Used in the Mouse Experiment

Figure I-1

**TOP SECRET**

I-2



25X1

**TOP SECRET**

CORONA HISTORY  
Volume IV

- F. Shipping, log book, and field procedures were reviewed and several modified.
- G. Environmental qualification testing of flight component designs was expanded and given increased emphasis.
- H. A thorough analysis of DISCOVERER XI provided several possible causes for failure to re-enter correctly. Reviews and tests were performed on all possible problem areas.
- I. Timing sequences in both the AGENA and the satellite recovery vehicle were reexamined and additional safety factors were incorporated to assure adequate time intervals existed between critical events to permit completion of one event before the start of the next.
- J. Simulated AGENA-SRV separation tests were performed, and any possible interference that might hamper the orientation of the SRV prior to ejection was eliminated.

With these studies and the first successful full camera operation on DISCOVERER XI, a decision was made to standdown with the CORONA photo reconnaissance program until a successful recovery could be made.

In DISCOVERERS XII and XIII the entire payload weight allowance was transformed into a diagnostic payload. Thus, the instrumentation carried in the SRV was devoted entirely to examining its own performance. The information was transmitted back to recovery stations by telemetry for complete details from ejection to recovery or for failure analysis if recovery were not achieved. The recovery vehicle was subjected to complete qualification tests at the Lockheed environmental facilities at Sunnyvale on an around-the-clock basis by Lockheed and GE engineers and technicians. One major change to the recovery system was made during this testing period. The hot gas rockets used to spin/despun the recovery vehicle to maintain its ballistic course had an uncertain reliability record. Repeated ground tests of these rockets left the Lockheed scientists and engineers with no confidence. As a result they designed and manufactured a cold gas spin/despun system to replace the hot gas rockets. When DISCOVERER XII failed to achieve orbit, DISCOVERER XIII was immediately placed in checkout and test and readied for launch.

On 10 August 1960 at Vandenberg Air Force Base, DISCOVERER XIII was launched successfully. Twenty-seven hours later, after the satellite had made 17 orbits around the earth, the ejection of the SRV was accomplished. A USAF C-119 aircraft received the radio signal from the descending SRV but could not get a bearing, and the capsule landed in the ocean approximately 330 miles northwest of Honolulu. Helicopters launched from the recovery ship, the USS Haiti Victory, flew to the impact point and recovered the capsule. When the Air Force received the capsule in Honolulu for transport back to the mainland, the Navy had taken

25X1

**TOP SECRET**



~~TOP SECRET~~

CORONA HISTORY  
Volume IV

advantage of the situation by painting in bold letters "Compliments of the US Navy" on the shipping can. The capsule was a modified MK II called a MK IID/IVD. Figure 1-2 presents pictures of high level military and civilian personnel observing the DISCOVERER XIII capsule.

With this recovery, the CORONA Program was on its way to a successful life span of 12 more years. The camera operation was successful on DISCOVERER XIV with recovery by a C-119 aircraft which caught the capsule at an altitude of 8,500 feet on 19 August 1960. Following this success the MK IV and MK V recovery capsules were developed. These capsules were used successfully right to the termination of the CORONA Program in 1972. The MK IV was an unpressurized vehicle for use on CORONA and the MK V a pressurized capsule for use on ARGON. Later, the MK V was used on MURAL and subsequent programs.

Successful recoveries became the rule rather than the exception with only minor improvements incorporated. On 3 March 1962 an unusual event occurred when the recovery team was unable to get the capsule from a MURAL I system completely into the shipping can. They shipped it back to the mainland perched atop the can. When the shipment reached the AP Facility in Menlo Park, California, engineers discovered a "bonus." The forebody had failed to separate from the capsule and had also been recovered. Engineers and scientists were able to study, for the first time, the re-entry effects on the ablative shield which protected the capsule during re-entry. Figure 1-3 provides photos illustrating this unique recovery, while Figure 1-4 allows a close-up view of re-entry effects. The forebody did not separate because one of the four squibs used to fire the ejection pistons which separate the forebody from the capsule upon parachute opening failed to fire. Fortunately, the parachute cover which was also separated by these squibs and pistons bent back under re-entry turbulence and allowed the parachute to slip out and open, thus making the recovery possible. There was concern following this recovery because of the possibility of the parachute not being able to deploy. A solution was found by slotting the four legs on the parachute cover so that if any three of the squibs/pistons fired, the cover could slip out of the grasp of the fourth leg and assure release of the parachute.

In 1961, at the direction of the CIA Contracting Officer, the contractual structure of the DISCOVERER payload system was changed. In 1962 the name DISCOVERER was dropped at GE, and the CORONA Program was designated A-45 until the program's completion in 1972.

In early 1963, with the capabilities of the THOR booster and the AGENA second-stage growing rapidly, a program called K-10 was initiated at GE based on estimates of attaining a 30 day orbit capability within a year.

25X1

**TOP SECRET**

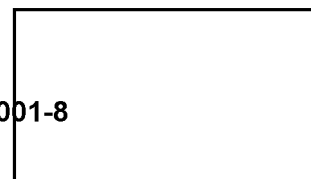

CORONA HISTORY  
Volume IV

RE-ENTRY HEATING EFFECTS

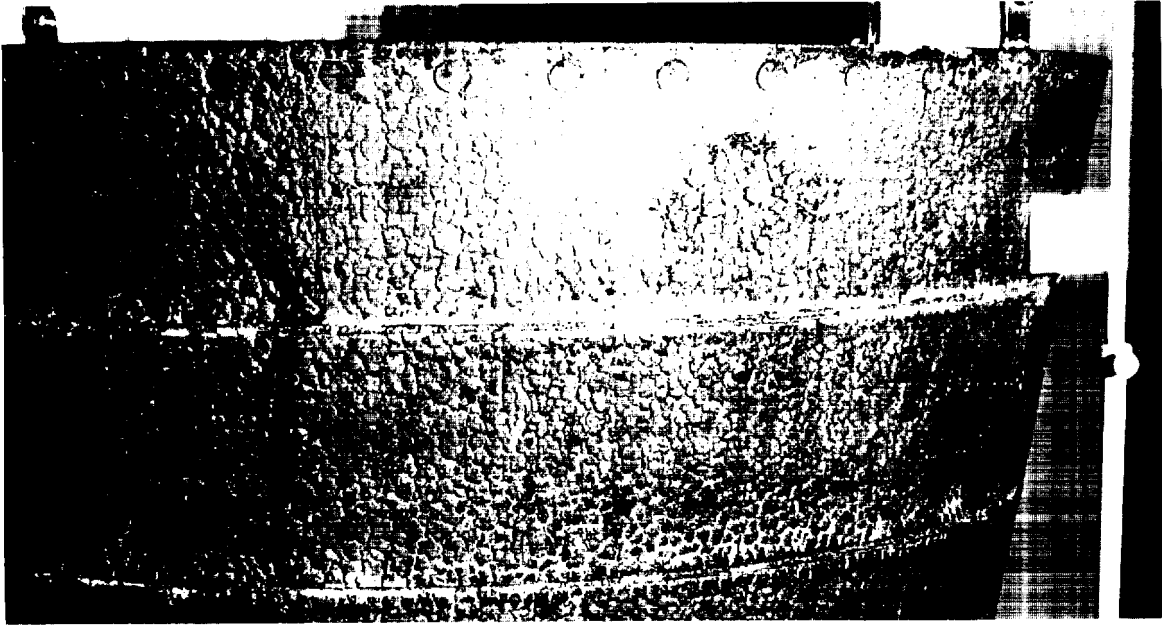

These Photographs Show the Effects of Re-entry Heating on the Phenolic Nylon Heat Shield at the Aft Skirt (above) and the Stagnation Point (below)

Figure 1-4

**TOP SECRET**

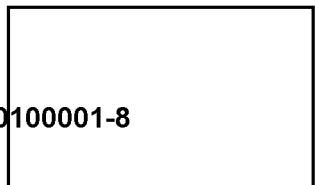

CORONA HISTORY  
Volume IV

DISCOVERER XIII  
THE WORLD'S FIRST SUCCESSFUL RECOVERY FROM SPACE



Generals White, Ritland, Schriever and Col Battle Observing the Recovery Capsule



Gen Schriever, Col Krause, and Senator Goldwater Examine the Capsule with a Member of the General Electric Research Department

Figure 1-2

**TOP SECRET**

25X1

**TOP SECRET**

CORONA HISTORY  
Volume IV

THE RECOVERED RV WITH HEAT SHIELD ATTACHED ARRIVES FOR DEFILMING

(Mission 9031 - SRV 581)



Col Murphy, L. Clarkson, J. Ousley,  
Col Bumm, J. Partanen Examining  
the Capsule upon Arrival at AP



J. Ousley and G. Gillespie  
Checking Additional Weight of Forebody

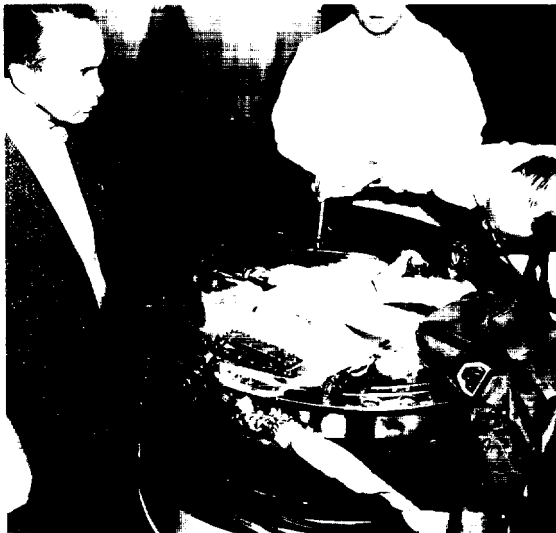

G. Stephenson, J. Pickett, J. Partanen  
Recording Details of Capsule



Extremely Useful Data Was Gained  
on Ablation Characteristics

Figure 1-3

**TOP SECRET**

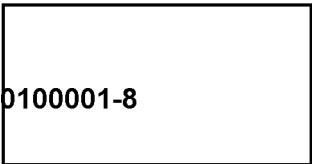

25X1

~~TOP SECRET~~

CORONA HISTORY  
Volume IV

A complete A-45 satellite recovery vehicle with takeups from Itek and film supplied by Eastman Kodak was subjected to a 30 day vacuum test at General Electric's Valley Forge facility, which it passed successfully. However, there were components in this test that were questionable, and a series of modifications were incorporated to increase confidence in the SRV. These modifications were:

A. A larger recovery battery called "Dreamboat" was designed to assure ample capacity for recovery events after 30 days on-orbit. With the failure to recover the first J-1 capsule, the Dreamboat battery was incorporated in all succeeding J-1 systems.

B. Addition of 100 cubic inches to the volume of the parachute cover since engineers theorized that although the parachute was packed solidly on the ground, it might grow under vacuum conditions. This expansion of the parachute under vacuum was never realized, but the added space under the parachute cover was invaluable in assembly methods of the parachute and in aiding the aircraft during recovery operations. After this modification, the CORONA Program never had a failure of cover/parachute ejection.

C. Early in the CORONA Program, a mechanical timer was installed to back up the regular recovery programmer for either recovery or destruction of the SRV through re-entry heating if proper re-entry trajectory had not been achieved. This timer, manufactured by Raymond, proved unreliable. Because of close tolerances and adjustments, Raymond could not produce them in their regular manufacturing shops but had to fabricate and assemble them in a model shop and could not meet schedules. The new Hayden Timer, incorporated by GE, was successful.

D. Redundancy signals in the thrust cone modules, thrust cone "all-fire" modifications, and a conformed coating over all parts and boards in the SRV programmers for protection against shorts during ascent vibration were also incorporated.

A most interesting, but unorthodox, recovery occurred in April 1964 on Mission 1005 with the assistance of many Venezuelans. This story is told in some detail in Volume I.

At the beginning of the CORONA Program, the SRV was produced as a subcontract to Lockheed. Many of the parts in the recovery vehicle, especially those that were peculiar to the photo reconnaissance mission, were designed, produced, and installed at the AP Facility. These included the device that cut the film and sealed the capsule before ejection, the sink and drain valves, the J-1 swing down ballast, the tunnels that shielded the film as it transferred from the camera to the capsule, and the nozzles and valves of the cold gas spin/despin system. In 1965, these devices continued to be manufactured at AP; however, with the implementation of the J-3 system (the VJ-SRV contract), these were shipped to GE for installation as part of

25X1

**TOP SECRET**



**TOP SECRET**

CORONA HISTORY  
Volume IV

the factory to pad concept. The only exception was the camera system takeup cassettes which continued to be installed in the capsule at AP.

The J-3 system design and development also resulted in several major new features in the SRV:

A. Although the Dreamboat battery had a good reliability record, it had deficiencies. After it was charged, its life was limited, and launch delays due to other problems could cause replacement. This was a major effort since the entire CORONA system had to be disassembled, the SRV disassembled, the battery replaced, the system reassembled, the camera system retracked, and the entire command and control sequence reverified. Since the J-3 system was to have a long storage life, the use of this battery was a limiting item. GE designed and developed a squib activated battery that could stay in storage for up to three years and be activated on-orbit before the recovery sequence. This battery was used throughout the J-3 Program without a failure.

B. Due to the incorporation of a recoverable tape recorder in the J-3 system by Lockheed, a new inflight disconnect system was developed which resulted in an increase in the number of wires that could be utilized across the interface from 55 to 61.

C. The recovery programmer was repackaged and the parachute delay sequence in the programmer reduced from 35 to 26 seconds. This allowed the drogue chute to be ejected at a higher attitude in order that the heavier (J-3) capsule could be stabilized before main chute deployment.

D. Incorporation of the MARK VC parachute.

E. The thrust cone on the SRV had been held on by two explosive bolts that were non-redundant. Engineers had not been satisfied with this type of separation since a failure in one bolt could cause loss of a mission. The bolts were replaced by a more reliable separation guillotine/cable device in which parallel pyro devices were incorporated.

F. A metal capsule cover was produced and coated with elastomeric shield material (ESM) to replace the previously supplied plastic cover.

G. The swing down ballast used on J-1 was replaced with a fixed ballast on the J-3 SRVs.

In 1968, with the extension of the J-1 and J-3 Programs, shelf life became a problem, and six J-1 SRVs were returned to GE and completely refurbished. Four J-3 SRVs used in qualification on QR-2 and CR-8 were also returned, refurbished, flown, and successfully recovered.

25X1

**TOP SECRET**



CORONA HISTORY  
 Volume IV

The SRVs were employed as follows:

- A. MK I - Mouse
- B. MK II - Primate
- C. MK IIA - CORONA C Series
- D. MK IV - CORONA C, C', and C''
- E. MK V - ARGON, LANYARD, and CORONA M and J Series
- F. MK IID/IVD - DISCOVERER XIII (Diagnostic)

A photograph of an SRV from each of the CORONA systems is shown in Figure 1-5. The last capsule returned for defilming prior to shipment to the Air Force Special Projects Production Facility for processing and duplication is shown in Figures 1-6 and 1-7. Table 1-1 outlines the evolution of the SRV and parachute design and development.

TABLE 1-1

DESIGN AND DEVELOPMENT EVOLUTION SUMMARY

<u>System</u>	<u>Subsystem</u>	<u>Component</u>	<u>Change</u>
MK II (Biomedical) to MK IIA	Recovery	Electrical harnesses	Changes to accommodate new payload and modified environmental control
	Environmental Control	Heater Thermostats Insulation Coatings	} Changed to suit new payload
	Payload		
MK IIA to MK IID	Orbit Ejection	Spin/Despin	Changed from solid rocket spin and despin units to cold gas nozzles, pressure bottles, and explosive valves
		Electrical harness	Changed to accommodate new spin/despin components as well as diagnostic circuits
	Re-entry	Electrical harness	Changed to accommodate diagnostic circuits
	Recovery	Capsule structure	Changed to accept diagnostic payload in place of scientific experiments
		Antennas	Changed from flexible stub to folded dipole type
		Electrical harnesses	Changed to accommodate diagnostic circuits
	Environmental Control	Heater Thermostats Insulation Coatings	} Changed to suit new payload

25X1

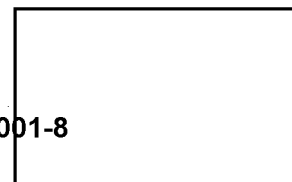

CORONA HISTORY  
 Volume IV

TABLE 1-1 (CONT'D)

<u>System</u>	<u>Subsystem</u>	<u>Component</u>	<u>Change</u>	
MK IIA to MK IID	Payload		Changed from film recovery to diagnostic package (sensors, T/M, tape recorder)	
MK IID to MK IV	Orbit Ejection	Thrust cone structure	Major structural redesign	
		Retrorocket	Design changed from TE 236A to improved TE 236B	
		Retroswitch	Change from single to double unit	
		Control modules	Changes in construction and components	
			Electrical harness	Changes to accommodate component modification
		Re-entry	Heat shield structure	Changed from all P/G shield to P/N ablator with P/G structural liner; changes to internal structural rings
			Ejection pistons	Design improvements to increase parachute cover
			Ejection squibs	Ejection velocity
			Electrical harness	Changed to improve disconnect between capsule harness and shield harness
		Recovery	Capsule structure	Major redesign to accommodate new payload and to improve structural strength
			Capsule cover	Major redesign to achieve compatibility with new capsule structure
			Recovery programmer	Design changed from pyro-actuated mechanical timer to redundant solid state timer
			Recovery battery	Changed from decentralized to central 14 volt power supply for recovery functions
			G-Switch assembly	Changed from single to multiple accelerometers for redundancy; changed vendor from Inertial Switch to Magnavox
	R. F. Beacon		Changed from CW beacon with integral 6 volt power pack to pulsed crystal-controlled beacon	
	Flashing light controller		Design change and vendor change from MSVD to Sonex	
	Antennas	Changed from folded dipole to rigid stub design		
	Pressure control valves	Design changes to all valves		
	Flashing light	Design change and vendor change from MSVD to Sonex		

25X1

**TOP SECRET**





CORONA HISTORY  
 Volume IV

TABLE 1-1 (CONT'D)

<u>System</u>	<u>Subsystem</u>	<u>Component</u>	<u>Change</u>
MK IID to MK IV		Parachute cover	Major design change
		Electrical harnesses	Changes to all harnesses because of change to central power supply and changes to components of recovery subsystem
	Environmental Control	Heaters Thermostats Insulation Coatings	} Changed to suit new payload
	Payload		
MK IV to MK V	Orbit Ejection		No major changes except revision to MK IV harness
	Re-entry		No major changes except revision to MK IV harness
	Recovery	Capsule structure	Changed to accommodate new payload
		Capsule cover	Changed to employ added pressure control valves
		Pressure control valves	Two valves added
		Flashing light	Design changed; vendor changed from Sonex to ACR
		Parachute cover	Design changed
		Electrical harnesses	Reverted from MK IVD (diagnostic) to MK IV harness
	Environmental Control	Heater Thermostats Insulation Coatings	} Changed to suit new payload
	Payload		
MK V to MK VA	Orbit Ejection	Spin/Despin	Changed design and changed vendor from Tavco to Menasco
		Ejection programmer	Changed housing design and time interval from spin-up to retrofire
	Re-entry	Heat shield structure	Redesigned forward and aft guides; changed P/N layout

25X1



CORONA HISTORY  
 Volume IV

TABLE 1-1 (CONT'D)

<u>System</u>	<u>Subsystem</u>	<u>Component</u>	<u>Change</u>
MK V to MK VA	Recovery	Capsule cover	Design change to suit new pressure valve arrangement
		Recovery programmer	Changed to provide higher altitude parachute deployment and to make compatible with destruct timer
		Recovery battery	Changed from 5 amp-hr battery to 8 amp-hr battery (with contoured envelope) on vehicle intended for 30 day orbit
		R. F. Beacon	Changed to improve exciter design; also packaged separate beacon controller into beacon housing
		Flashing light controller	Redesigned to give increased output and reliability
		Backup timer	Added this component to the subsystem
		Pressure control valves	Decreased number of valves and relocated the remainder
		Parachute	In succession, the following changes were made: (1) from 24 ft single to 30 ft dual chute, (2) increased size of drogue chute to 6.9 ft, (3) changed main chute to ring-slot type
		Parachute cover	Redesigned attachment means to permit ejection with 3 of 4 pistons operative; increased spare available for parachutes
		Electrical harness	Changed to accommodate other subsystem changes
	Environmental Control		No major changes
	Payload		Changed to a dual 70mm width film package for MURAL and subsequently added an additional 5 inch film package for DISIC on the J-3 design

25X1

**TOP SECRET**

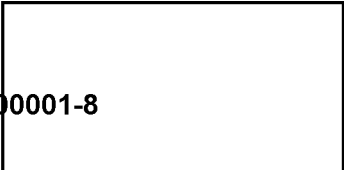

~~TOP SECRET~~

CORONA HISTORY  
Volume IV

TABLE 1-1 (CONT'D)

Parachute  
Evolution

Design and development of the MK VA Parachute Recovery System initiated on 16 August 1961. First operational use of this system was on FTV 1123 in March 1962.

First operational use of a 34 second recovery timer was on FTV 1124 in April 1962.

Design and development of the MK VB-3 Parachute Recovery System on 15 October 1962. First operational use of the MK VB-3 system was on FTV 1156 in December 1962.

First operational use of the MK VB-4 system was on FTV 1165 in May 1963.

First operational flight with the 6.9 foot deceleration parachute was on FTV 1615-1 in May 1965.

First operational use of the MK VC Parachute Recovery System was on FTV 1634-1 in May 1967.

First flight with the 26 second recovery timer was on FTV 1641-1.

25X1

**TOP SECRET**

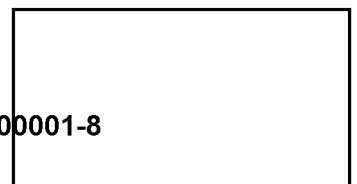

**TOP SECRET**

CORONA HISTORY  
Volume IV

RECOVERED CAPSULES FROM DIFFERENT CORONA SYSTEMS

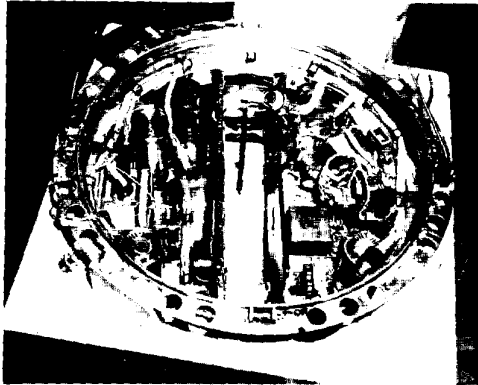

"C" Capsule (Nov 1961)

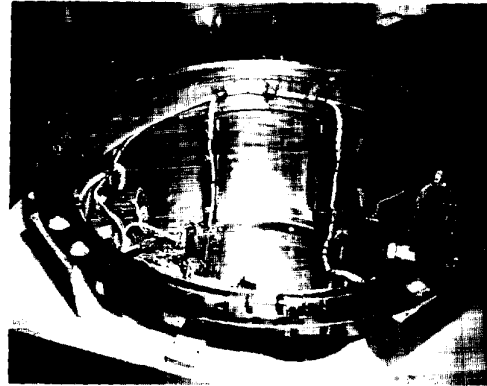

"A" Capsule (May 1962)



"L" Capsule (May 1963)



"M" Capsule (Jun 1963)

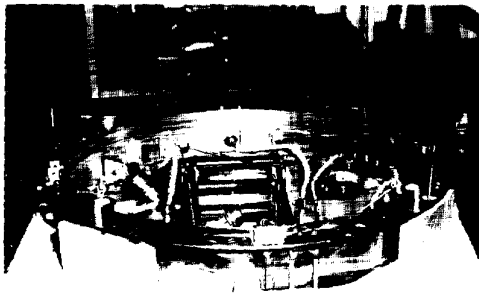

J-1 Capsule (1964)

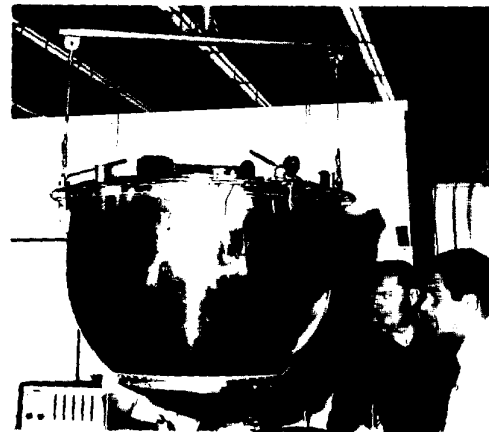

The First J-3 Capsule (Sep 1967) Examined by  
W. Cottrell and J. Nemer-Kaiser

Figure 1-5

**TOP SECRET**

**TOP SECRET**

CORONA HISTORY  
Volume IV

THE LAST CORONA CAPSULE

(Mission 1117, May 72)



R. Boettcher, A. Garza, and M. Lindgren  
Assisted in Hoisting Capsule from Shipping Can

Figure 1-6

**TOP SECRET**

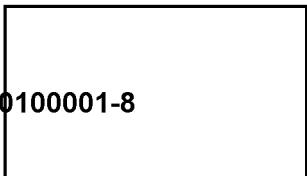

**TOP SECRET**

CORONA HISTORY  
Volume IV

THE LAST CORONA DEFILMING



Film Suitcases Used to Carry the Exposed Film from the Defilming Site in California to  
AI'SPPF, Westover AFB, Massachusetts



Defilming Team after Completion of Their Last Task on Mission 1117-2  
Rear - K. Perryman, H. Barnes, R. Boottcher, A. Carza, H. Rochette  
Front - J. Wendt, L. Mar, P. Donahue

25X1

Figure 1-7

**TOP SECRET**

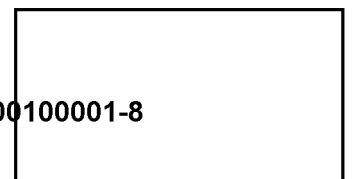

~~TOP SECRET~~

CORONA HISTORY  
Volume IV

SECTION II

SATELLITE RECOVERY VEHICLE

The functions of the satellite recovery vehicle (SRV) are to provide: (1) a structural, heat resistant nose cone section for the launch vehicle; (2) a thermal and light protection for the inner capsule which collects and stores the film during orbital operations and re-entry; and (3) a separable re-entry vehicle (RV) with appropriate subsystems to de-orbit the film capsule and protect the film until it can be recovered, transported, and downloaded. Figure 2-1 presents a picture of a CORONA J-3 SRV.

The SRV characteristics changed over the life of the CORONA Program as initial thrust, camera systems, and film loads changed. Table 2-1 lists the data which characterizes the SRV used with the J-3 camera system.

TABLE 2-1

SUMMARY OF J-3 CAMERA SYSTEM SRV CHARACTERISTICS

<u>Parameter</u>	<u>Specification</u>
Separation weight	414 pounds maximum
Re-entry vehicle weight	323 pounds maximum
Suspended weight	120 to 217 pounds (nominally 215)
Hypersonic ballistic coefficient	68 pounds/ft <sup>2</sup> maximum
Total impulse (retrorocket)	10,500 pound-seconds $\pm$ 3 percent
Rate of descent (at 10,000 feet)	28.5 feet/second maximum
Aerial recovery (JC-130)	15,000 foot altitude maximum 135 knots air speed maximum
Water recovery flotation period	55 to 95 hours
Reliability	.984 (each SRV)
J-3 panoramic film recovered	80 pounds (40 pounds/SRV)
DISIC film recovered	11.3 pounds

The SRV configurations used with the J-1 and the J-3 systems are illustrated in Figure 2-2. Figure 2-3 is a drawing of the SRV which identifies the major SRV assemblies. These major SRV assemblies are then portrayed in detail in Figures 2-4 through 2-9. The configuration used in these figures is the MK V (Series 800) which was designed and produced for the CORONA J-3 system. Figure 2-10 presents pictures showing the assembled SRV without the retrorocket and the SRV with thrust cone, thermal cover, and parachute removed. In view is the capsule cover showing the pan and DISIC film cutter/sealers, the flashing light, and the electrical disconnect.

25X1

~~TOP SECRET~~

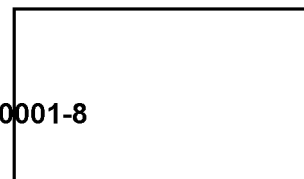

**TOP SECRET**

CORONA HISTORY  
Volume IV

SATELLITE RECOVERY VEHICLE



Figure 2-1

**TOP SECRET**



~~TOP SECRET~~

CORONA HISTORY  
Volume IV

SATELLITE RECOVERY VEHICLE CONFIGURATIONS

— J-1 System —

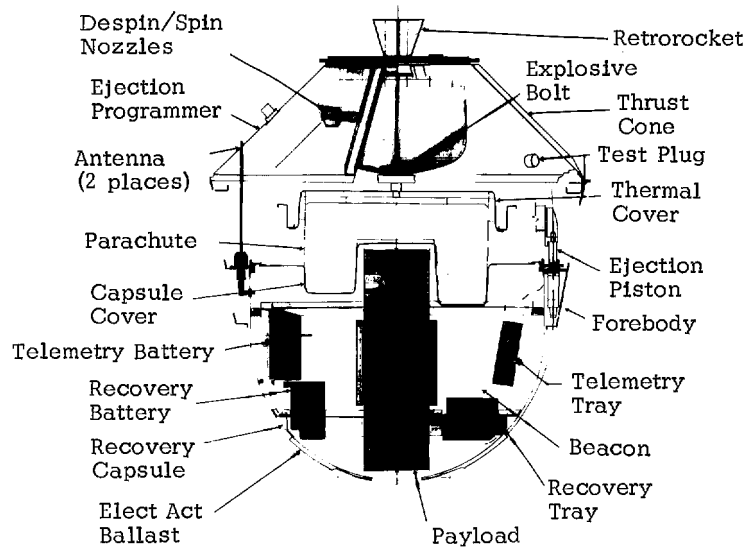

— J-3 System —

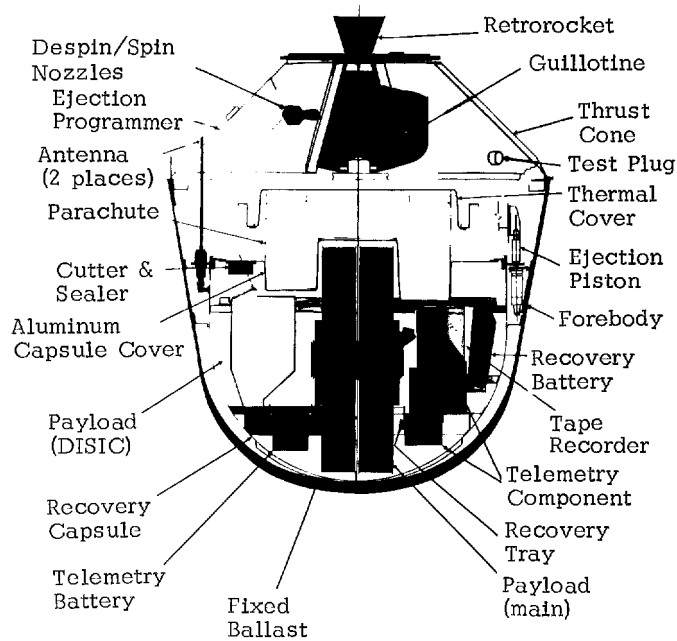
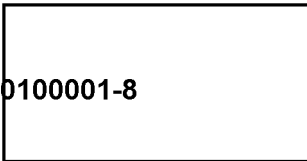

Figure 2-2

**TOP SECRET**



**TOP SECRET**

CORONA HISTORY  
Volume IV

MAJOR SATELLITE RECOVERY VEHICLE ASSEMBLIES

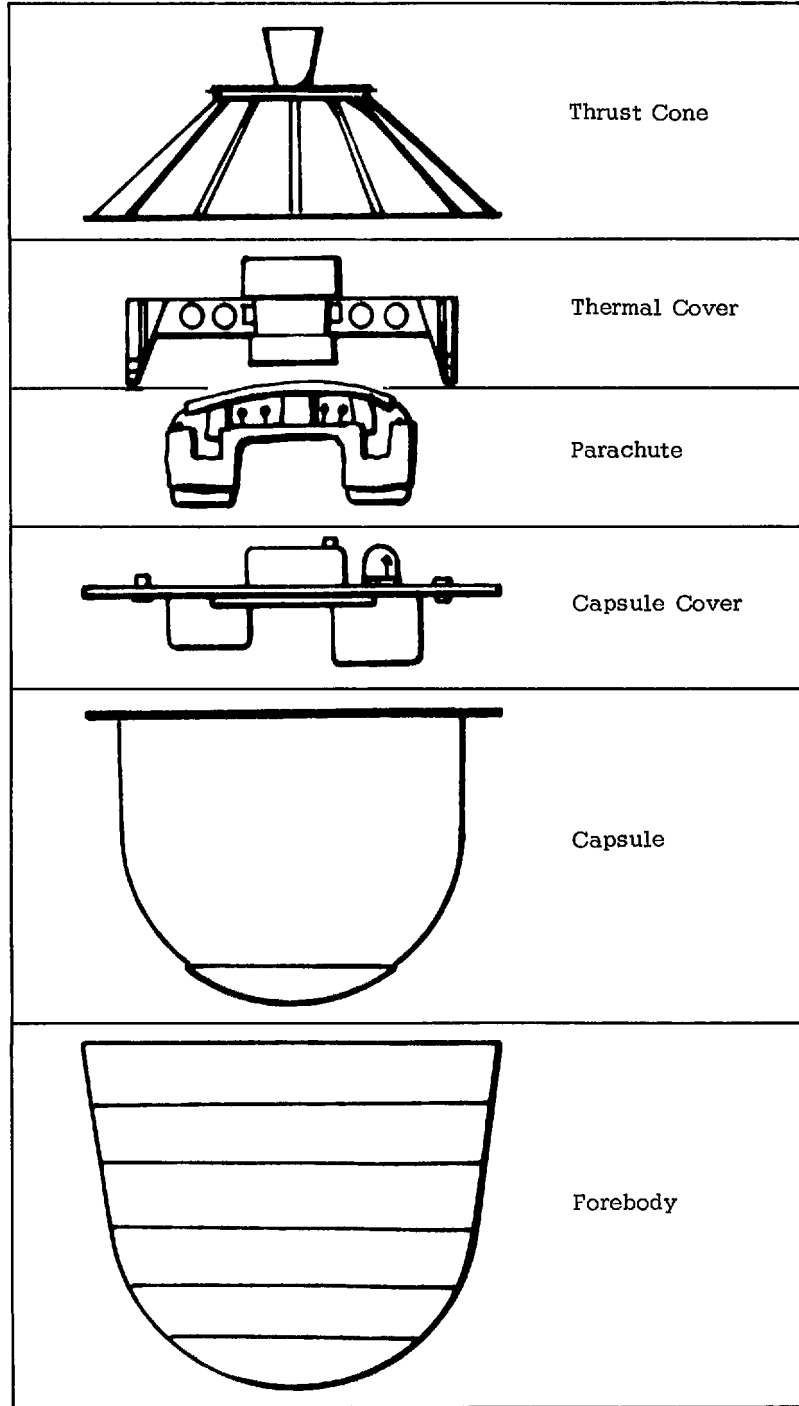

Figure 2-3

**TOP SECRET**

TOP SECRET

CORONA HISTORY  
Volume IV

THRUST CONE ASSEMBLY

— External View —

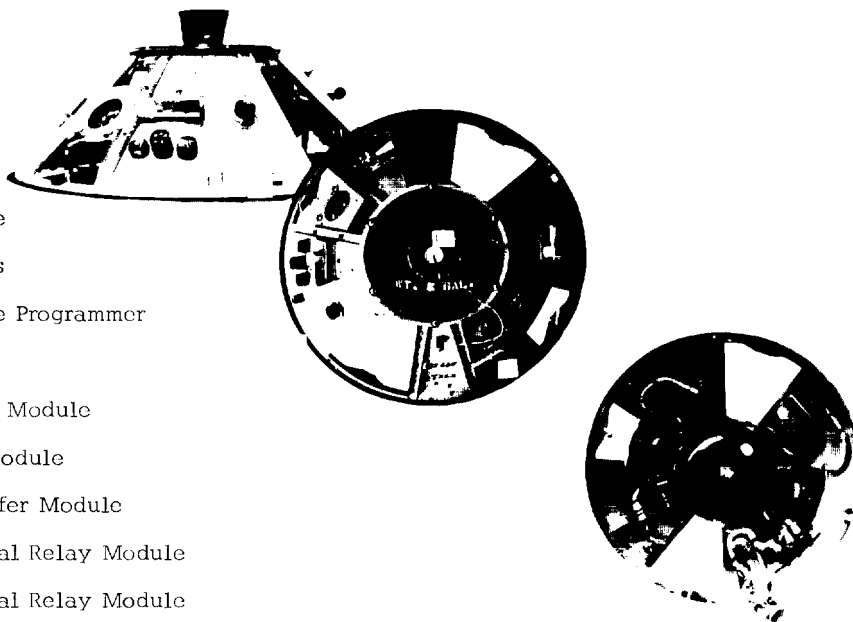

1. Thrust Cone
2. W1 Harness
3. Thrust Cone Programmer
4. Baroswitch
5. 1A18 Diode Module
6. 1A26 Arm Module
7. 1A27 Transfer Module
8. 1A15 Thermal Relay Module
9. 1A14 Thermal Relay Module
10. Thermal Batteries (2 ea)

— Inner View —

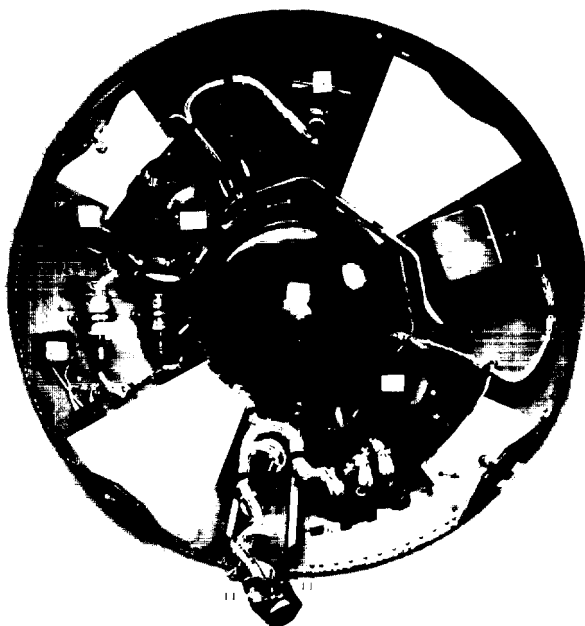

11. Thrust Cone/Capsule Disconnect Squibs
12. Thrust Cone/Forebody Explosive Bolts
13. Spin Valve Squibs
14. Despin Valve Squibs
15. Retrorocket Igniter
16. Retrorocket
17. Cold Gas Spin/Despin System
  - a. Spin and Despin Pressure Bottles
  - b. Spin and Despin Squib Actuated Valves
  - c. Spin and Despin Nozzles
  - d. Spin and Despin Tubing Assemblies
  - e. Spin and Despin Bottle Mounting Brackets
18. SRV Separation Switch Actuating Brackets
19. Temperature Sensors
20. Separation Springs

Figure 2-4

TOP SECRET

**TOP SECRET**

CORONA HISTORY  
Volume IV

THERMAL COVER ASSEMBLY

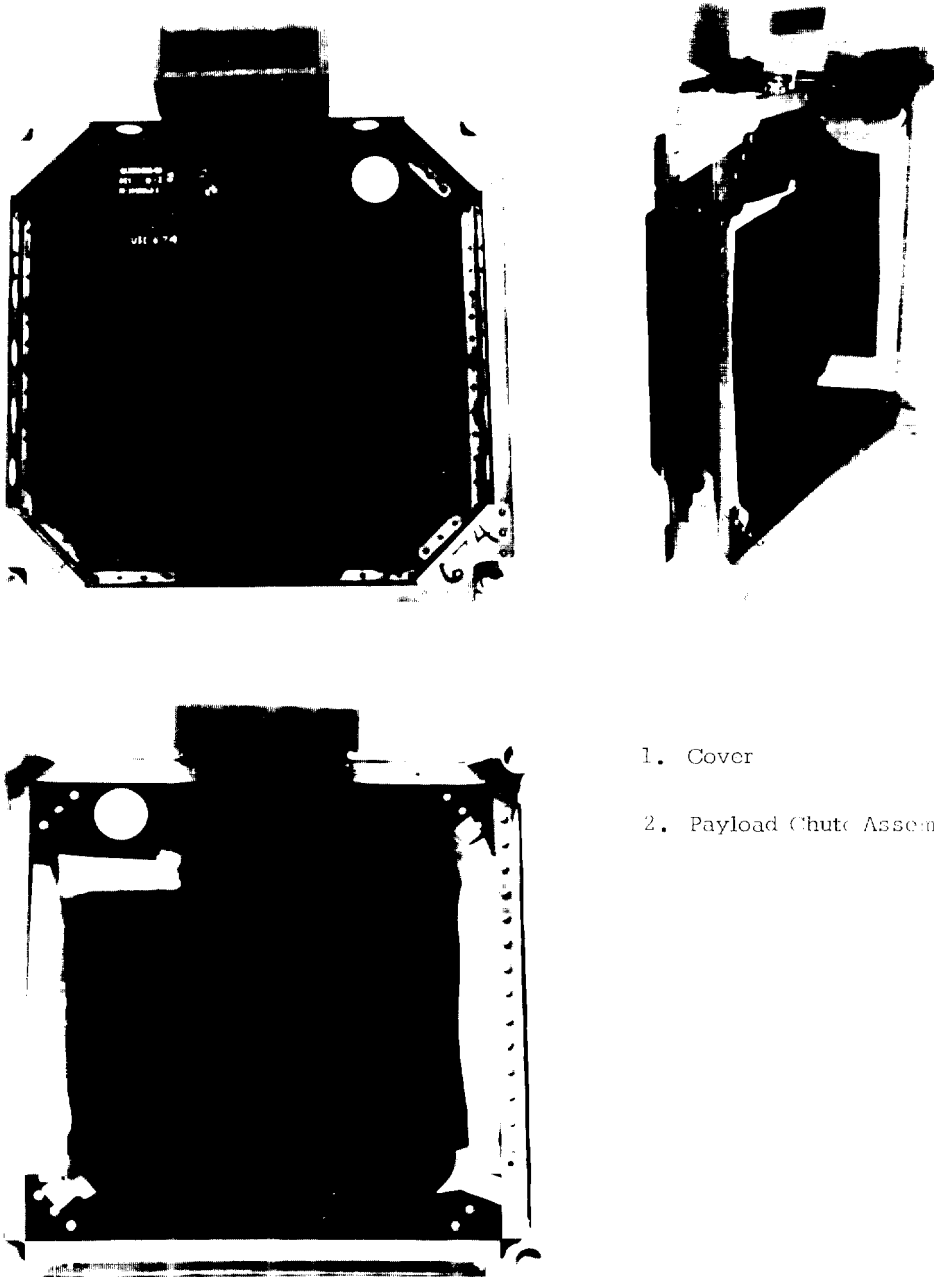

- 1. Cover
- 2. Payload Chute Assembly

25X1

Figure 2-5

**TOP SECRET**

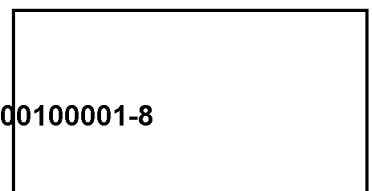

~~TOP SECRET~~

CORONA HISTORY  
Volume IV

RECOVER PARACHUTE SYSTEM



Figure 2-6

**TOP SECRET**

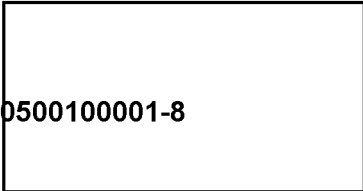

~~TOP SECRET~~

CORONA HISTORY  
Volume IV

CAPSULE COVER ASSEMBLY

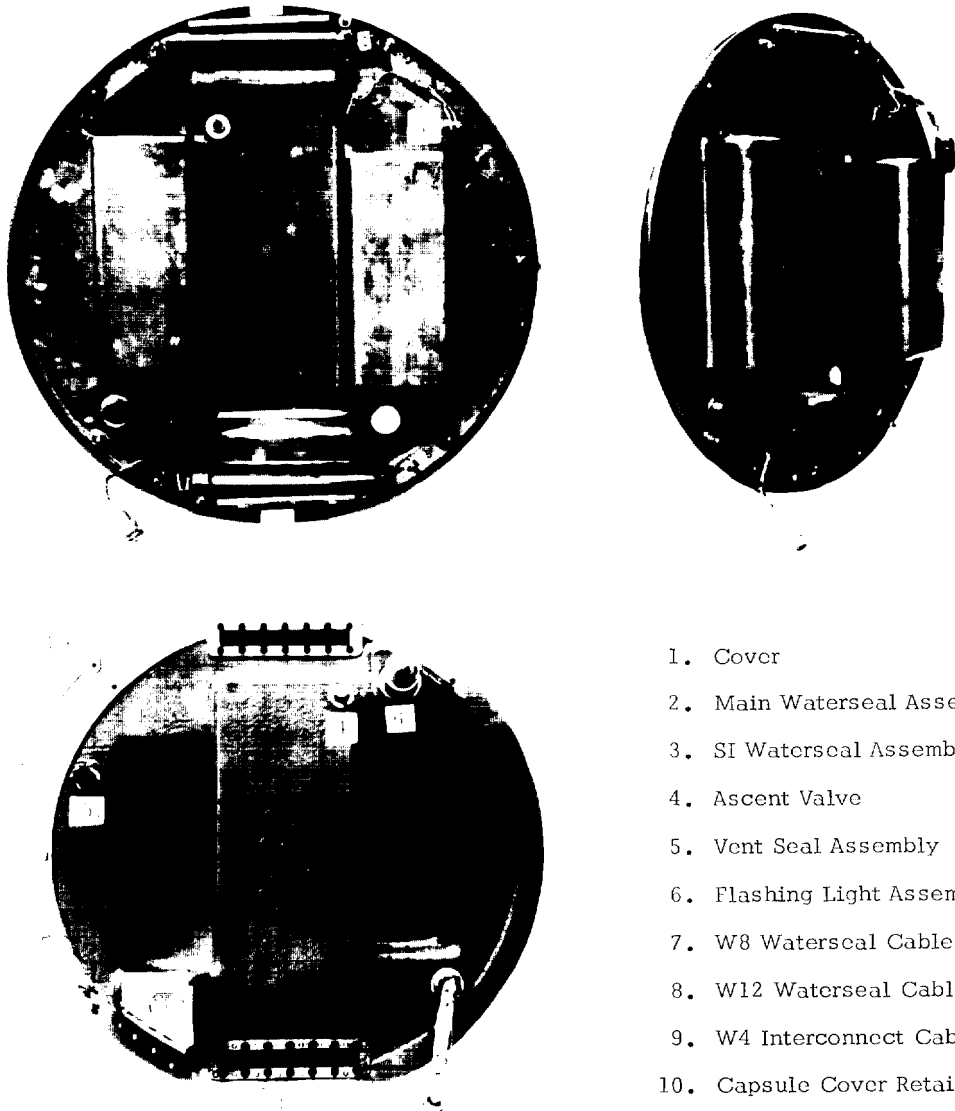

1. Cover
2. Main Waterseal Assembly
3. SI Waterseal Assembly
4. Ascent Valve
5. Vent Seal Assembly
6. Flashing Light Assembly
7. W8 Waterseal Cable
8. W12 Waterseal Cable
9. W4 Interconnect Cable
10. Capsule Cover Retaining Rings

Figure 2-7

**TOP SECRET**

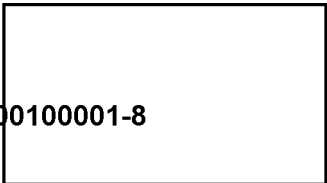

CAPSULE ASSEMBLY

— External View —

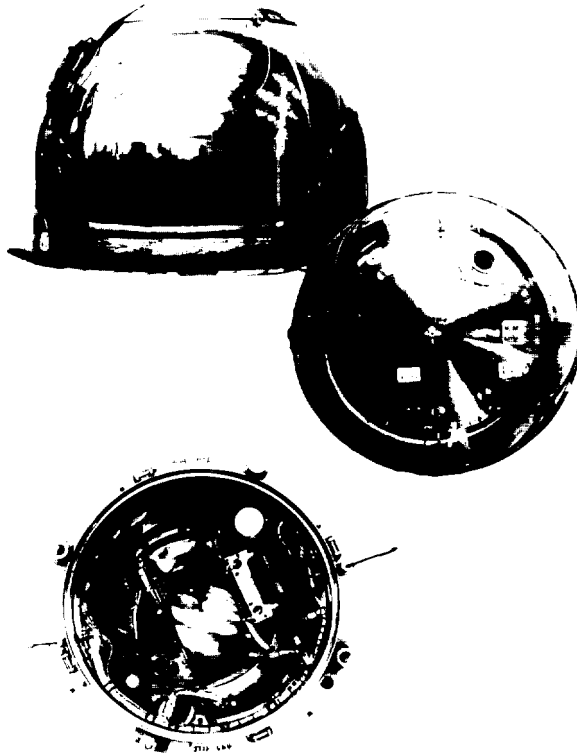

- 1. Capsule
- 2. TM Antenna Assembly
- 3. Beacon Antenna Assembly
- 4. W2 Harness
- 5. W10 Beacon Antenna Cable
- 6. W11 TM Antenna Cable
- 7. 2A14 Waterscal Module
- 8. 4A5 Thermal Relay Module
- 9. FM/ FM TM Assembly
- 10. TM Battery
- 11. Recovery Battery

— Inner View —

- 12. Recovery Tray Assembly
  - a. Recovery Programmer
  - b. Beacon Assembly
  - c. Destruct System Timer
  - d. Flashing Light Controller
  - e. "G" Switch Assembly
- 13. Research Payload Bracket
- 14. TM Battery Bracket
- 15. Recovery Battery Bracket
- 16. Sink Valve
- 17. Drain Valve
- 18. Flotation Ballast
  - a. Cable Cutter
  - b. Research Payload

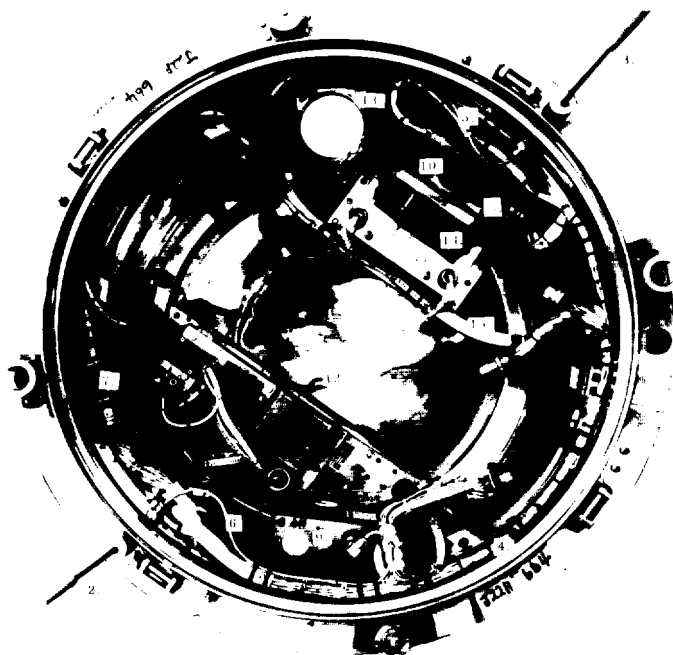
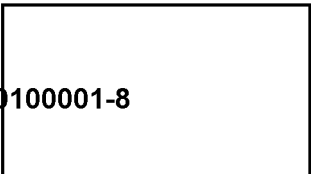

Figure 2-8

**TOP SECRET**



~~TOP SECRET~~

CORONA HISTORY  
Volume IV

FOREBODY ASSEMBLY

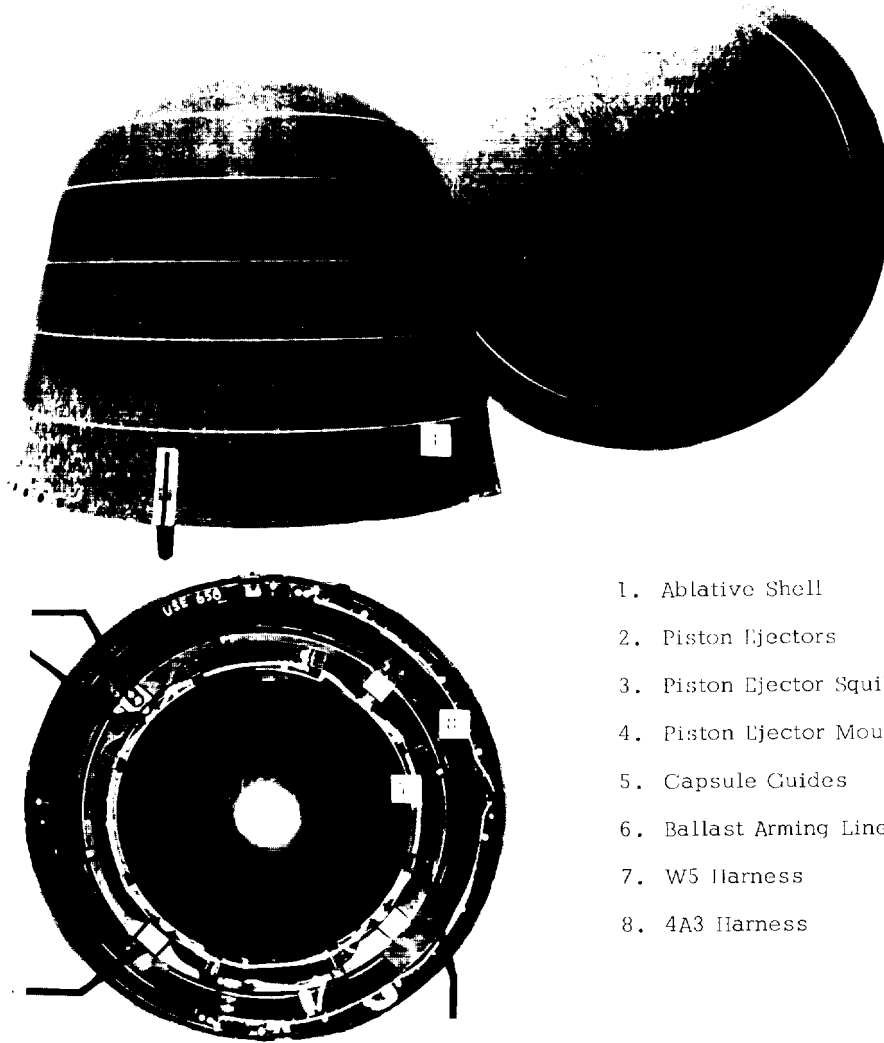

1. Ablative Shell
2. Piston Ejectors
3. Piston Ejector Squibs
4. Piston Ejector Mounting Hardware
5. Capsule Guides
6. Ballast Arming Line (Not Visible)
7. W5 Harness
8. 4A3 Harness

25X1

Figure 2-9

**TOP SECRET**

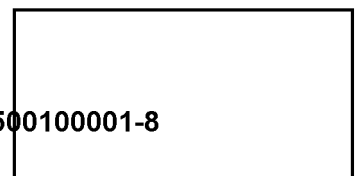



~~TOP SECRET~~

CORONA HISTORY  
Volume IV

THE MK V J-3 CAMERA SYSTEM SRV

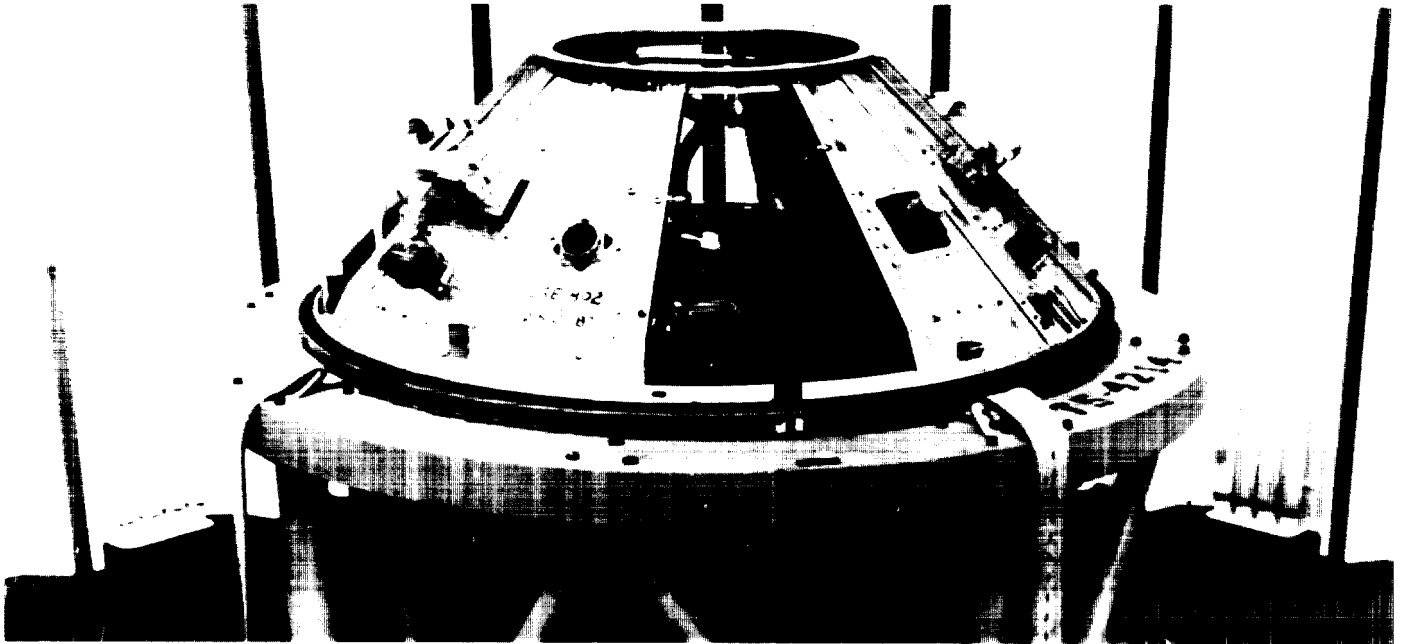

SRV with Retrorocket Removed

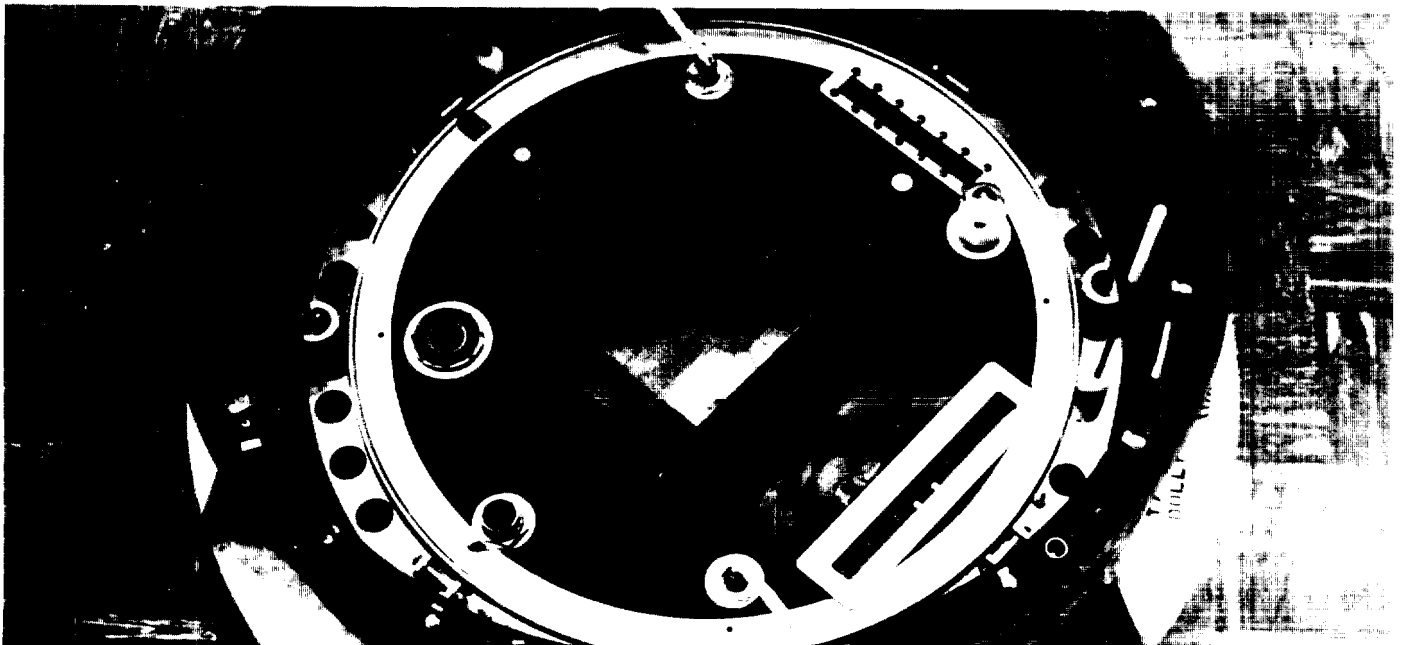

SRV with Parachute Removed

25X1

Figure 2-10

**TOP SECRET**



~~TOP SECRET~~

CORONA HISTORY  
Volume IV

The J-3 SRV is an integrated composite of equipment supplied by a group of associate contractors with AP as the systems integrator. The Forebody, capsule, and thrust cone were supplied by General Electric. Itek and Fairchild provided the film takeup cassettes. Lockheed provided the tape recorder, telemetry system with TM battery, the parachute recovery subsystem, the MAIN and DISIC waterseals, and the spin and despin valves and pyro squibs for the cold gas spin system. The waterseals and the spin valves were acceptance tested at Lockheed and then shipped to GE for installation in the SRV. When received at AP, all equipment was considered as government furnished equipment (GFE). AP installed, assembled, and integrated all interfacing subsystems, and tested and integrated the SRV as both a self contained system and as an integrated subsystem of the J-3 system.

The SRV is described below under the following categories: (1) the orbit ejection system, (2) the recovery capsule and equipment, (3) the Forebody, (4) the parachute, and (5) the parachute cover.

ORBIT EJECTION SYSTEM

The thrust cone is a truncated, aluminum structure upon which the components performing the orbit ejection functions are mounted. These functions in operational sequence are:

- A. Separation of the re-entry vehicle from the system by pyrotechnically released pin pullers in conjunction with spring pushers.
- B. Spin-up of the SRV producing a roll rate of 55 to 65 rpm under conditions of maximum roll inertia.
- C. Thrust generation to produce the orbit ejection velocity increment. The thrust must be sufficient to impart a nominal velocity along the thrust vector of not less than 800 feet per second for nominal mass conditions. Retro ignition occurs approximately 6 seconds following disconnect.
- D. Despin of the RV slows the spin rate to yield a residual spin of approximately 9 rpm to distribute re-entry heat uniformly over the surface of the Forebody. The despin operation requires less gas than the spin operation.
- E. The thrust cone is then jettisoned approximately 18.25 seconds after disconnect.

The spin system is composed of a gas reservoir, a pyrotechnically actuated valve, and two nozzles which are located diametrically opposite each other and similarly pointed in a direction to allow the gas to spin the RV in an axial, counterclockwise rotation. The spin tank reservoir is a welded, stainless steel sphere with a burst pressure of 7,000 psi gas pressure. The flight tank is filled with a combination of gases to a working pressure of 3,000 psi. The physical characteristics are:

- A. The bottles are 5 inches in diameter. They are filled with 89 percent nitrogen, 10 percent Freon, and have a trace of helium (1 percent) for leak detection purposes.

25X1

**TOP SECRET**



~~TOP SECRET~~

CORONA HISTORY

Volume IV

- B. Gas weight per bottle is .65 pound.
- C. Specific impulse =  $59.5 \frac{\text{lb secs}}{\text{lbs of gas}}$
- D. Total impulse =  $59.5 \frac{\text{lb secs}}{\text{lbs gas}} \times .65 \text{ lb} = 39 \text{ lb sec}$

The despin system duplicates the spin system except that the nozzles are pointed in the opposite direction to effect a clockwise spin and are located 90 degrees from each spin nozzle. The despin tank has a working gas pressure of 2,400 psi.

The retrorocket is a solid propellant rocket which imparts a thrust of 1,000 pounds for approximately 10 seconds' duration. The purpose of the retrorocket is to decelerate the RV. The rocket fuel is polyurethane, the oxidizer is ammonium perchlorate, and the igniter is composed of boron pellets. The physical characteristics are:

- A. Total packaged weight is 63 pounds.
- B. Burn time is approximately 8 seconds.
- C. Propellant weight is 40 pounds.
- D. Specific impulse =  $260 \frac{\text{lb secs}}{\text{lbs}}$
- E. Total impulse =  $260 \frac{\text{lb secs}}{\text{lbs}} \times 40 \text{ lbs} = 10,400 \text{ lb secs}$
- F. Average thrust = 1,136 lbs
- G. Maximum thrust = 1,609 lbs

The ejection programmer is a solid state electrical timer which feeds precisely timed electrical impulses to the spin/despin system, the retrorocket, in-flight electrical disconnect, and the thrust cone retainer pyrotechnics (guillotine) which, with the aid of four separation springs, collectively effect separation of the orbit ejection subsystem from the recovery vehicle.

RECOVERY CAPSULE AND EQUIPMENT

The capsule is a dome-shaped, spun aluminum structure, see Figure 2-8. It is plated with gold for thermal purposes and has a sink valve to allow it to sink if the capsule is lost at sea. The capsule houses the following components and subassemblies:

- A. The main takeup cassette and its mounting hardware.
- B. The DISIC takeup cassette and ancillary hardware.
- C. A tape recorder.
- D. The recovery equipment. A remotely activated 5 ampere-hour battery powers the recovery equipment (except the telemetry subsystem) by providing a voltage output of 14.8 to 17.0 vdc at .7 to 1.2

25X1

**TOP SECRET**

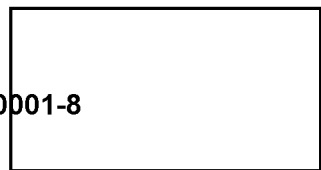

CORONA HISTORY  
Volume IV

amperes load from each of two batteries housed in one stainless steel envelope. These batteries furnish power from shortly prior to separation to a minimum of ten hours after water impact. This power also is used to eject the parachute and to operate the recovery aids, a flashing light, and a radio beacon transmitter.

E. The telemetry (TM) subsystem recovery event data is transmitted to the ground stations by a telemetry transmitter. The telemeter system consists of three VCOs, one each for IRIG channels 7, 9, and 11; an accelerometer with a range of  $\pm 5$  G; and a 1.5 watt transmitter on a frequency of 228.2 megacycles. The TM system is powered by a single silver-zinc battery having a nominal 28 vdc rating and a minimum capability of .6 ampere-hours. The power duration specification is a minimum of 30 minutes. The battery is remotely activated by the command, ARM 1.

F. A backup electronic timer initiates a DESTROY command in the event a malfunction prevents successful re-entry prior to 1,500 seconds after ARM command. The timer bypasses the RETRO command and sends another command (called SEPARATE) to the thrust cone and parachute system. This command sequence serves to disallow a successful re-entry by providing sufficient drag force which would result in burning up the RV.

G. The recovery beacon transmitter is a VHF unit which operates on a carrier frequency of 225 megacycles  $\pm .01$  percent. Power is supplied by the recovery battery. The signature is a unique, variable pulse rate frequency signal. The purpose during descent and/or water impact is to provide a recognizable sound to the search craft until the capsule is visually sighted and retrieved.

H. The flashing light is a backup recovery aid used to assist recovery crews in locating a capsule at night. The light is omnidirectional above the horizon and is designed to be visible at sea on a cloudless night by a search plane five miles away flying at an elevation of 10,000 feet.

I. The recovery programmer is a solid state timer which issues electrical commands through a variety of time delay/relay activities, initiating the events subsequent to the orbit ejection sequence. These events, known as the recovery events, are: (1) ejection piston pyro-actuated, (2) flashing light energized, (3) parachute sequence, and (4) backup timer energized.

J. The inertia switch module is comprised of a bank of four viscous damped 3 G inertia switches, any two of which must operate. The purpose of these switches is to provide a time delay between orbit ejection and recovery events using the re-entry dynamics properties to trigger the recovery programmer.

K. Water seals are installed on the capsule cover for a twofold purpose: (1) to cut the main camera and DISIC films and (2) to seal the capsule from light, water, and other contaminants.

An independent source of electrical power is provided in each RV to support orbit ejection and separation of the thrust cone. This power is provided by dual thermal batteries, each capable of supplying loads up to 9.0 amperes at 31 vdc for a minimum period of 20 seconds.

25X1

**TOP SECRET**

2-14

**TOP SECRET**

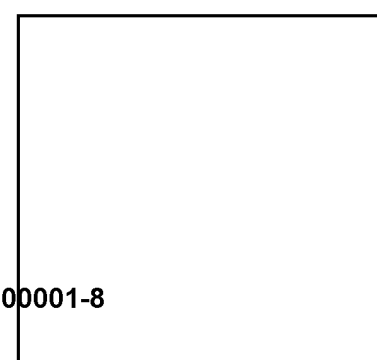

~~TOP SECRET~~

CORONA HISTORY  
Volume IV

### SECTION III

#### RE-ENTRY AND RECOVERY OPERATIONS

The purpose of re-entry and recovery is to accomplish the atmospheric re-entry of the recovery vehicle (RV) and the subsequent air snatch or water retrieval of the capsule which contains exposed film and tape recorded gas jet, time word, slit width, and filter position data. The de-orbit, re-entry, and retrieval functions comprise a sequence of events involving the satellite, the SRV, the tracking stations, and the air and sea recovery forces.

The recovery sequence is started from the Vandenberg Tracking Station (VTS) by an ENABLE command backed up by a command from the Kodi Tracking Station (KTS). Normally, the trajectory of the RV is within radar range. The recovery force aircraft are deployed to cover the computed recovery impact point in a controlled search pattern at 10,000 to 20,000 feet altitude. The aircraft and tracking station search equipment is tuned to the frequencies of the RV RF beacon and the Blossom TM in a method which enables determining the position of the RV by triangulation.

The orbital parameters and the nominal free flight ballistic trajectory of the SRV are precomputed. This data is updated and corrected for known variables shortly before the start of recovery operations. The satellite assumes the required spatial orientation to eject the SRV in the direction for atmospheric re-entry, upon receipt of the proper SECURE real time command (RTC). These spatial orientations are 120 degrees for orbit vector for primary modes and variable for Lifeboat modes. The internal events occurring in the AGENA during the 120 degree pitchdown maneuver, together with the associated pyrotechnic events occurring in the J-3 payload system, prepare the SRV for free-flight operation during de-orbit. Figure 3-1 illustrates desired re-entry parameters.

The Satellite Test Center (STC) located at Sunnyvale is the center for mission communications, acquisition, command, and control. Major mission decisions such as time and location of recovery, recovery initiation, length of mission, and mission conclusion are made and transmitted from STC.

Network tracking stations (Vandenberg, Kodi, and Hula) provide velocities, and telemeterized functions data, as well as forwarding all STC requirements to the satellite vehicles (SV). In addition to these normal tracking station functions, the Hula, Hawaii Tracking Station (HTS) acts as the center for the RV recovery and recovery forces. The relationship between tracking stations and the SV, SRV, and recovery forces is shown in Figure 3-2. The recovery sequence is illustrated in Figures 3-3 and 3-4. In addition, detailed recovery events are presented in Table 3-1.

25X1

**TOP SECRET**

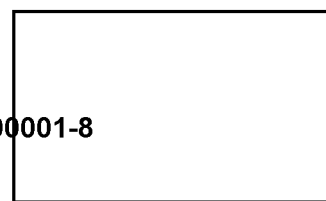
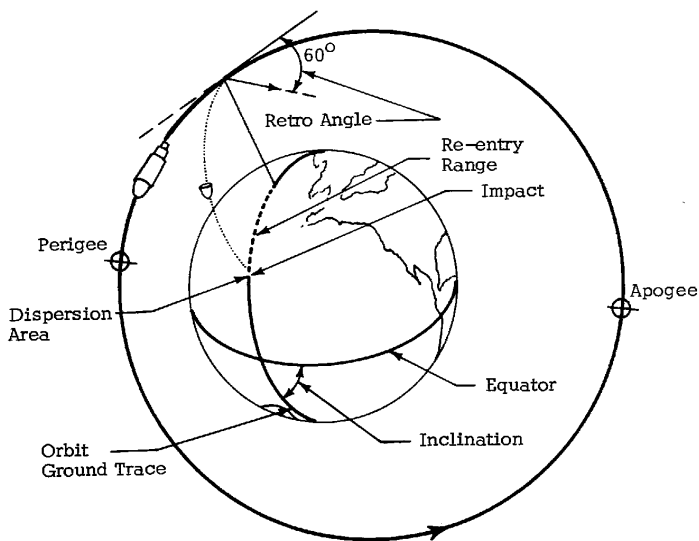

Figure 3-1

RE-ENTRY PARAMETERS



MISSION

- Perigee - 85 nm
- Apogee - 210 nm
- Period - 90.04 min

RE-ENTRY PERFORMANCE

- Retro Velocity - 850 fps
- Retro Angle - 60°
- $\frac{W}{CDA} - 68 \frac{\text{lbs}}{\text{ft}^2}$
- Range - 1,900 nm
- Dispersions (normal)
  - Up range 50 - 100 nm
  - Down range 60 - 180 nm
  - Cross range  $\pm 10$  nm
- Heating
  - $q$  Total 27,000 btu/ft<sup>2</sup> (limit)

TOP SECRET

3-2

TOP SECRET

25X1

Figure 3-2

SATELLITE CONTROL FACILITY OPERATION IN RECOVERY

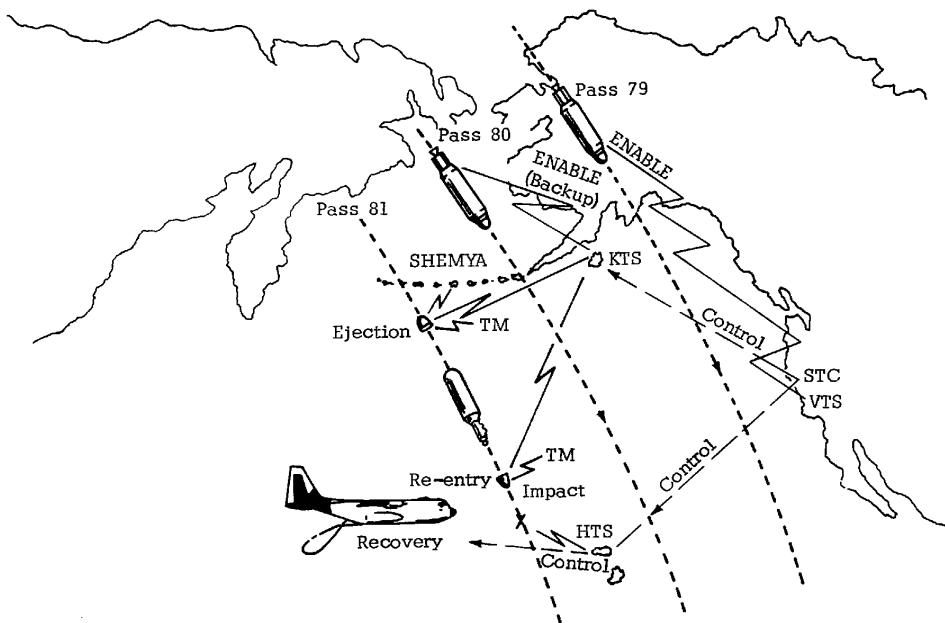

TOP SECRET

TOP SECRET

3-3

25X1

Figure 3-3

RECOVERY SEQUENCE

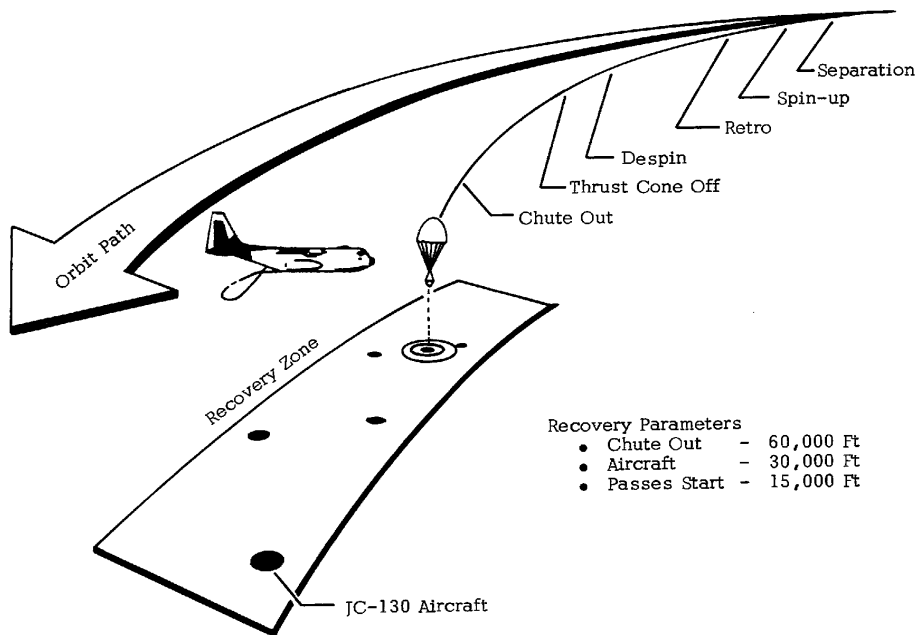

NOTE: Normally four JC-130 Aircraft are used to pattern-search the Recovery Zone.



Figure 3-4

RECOVERY SEQUENCE OF EVENTS

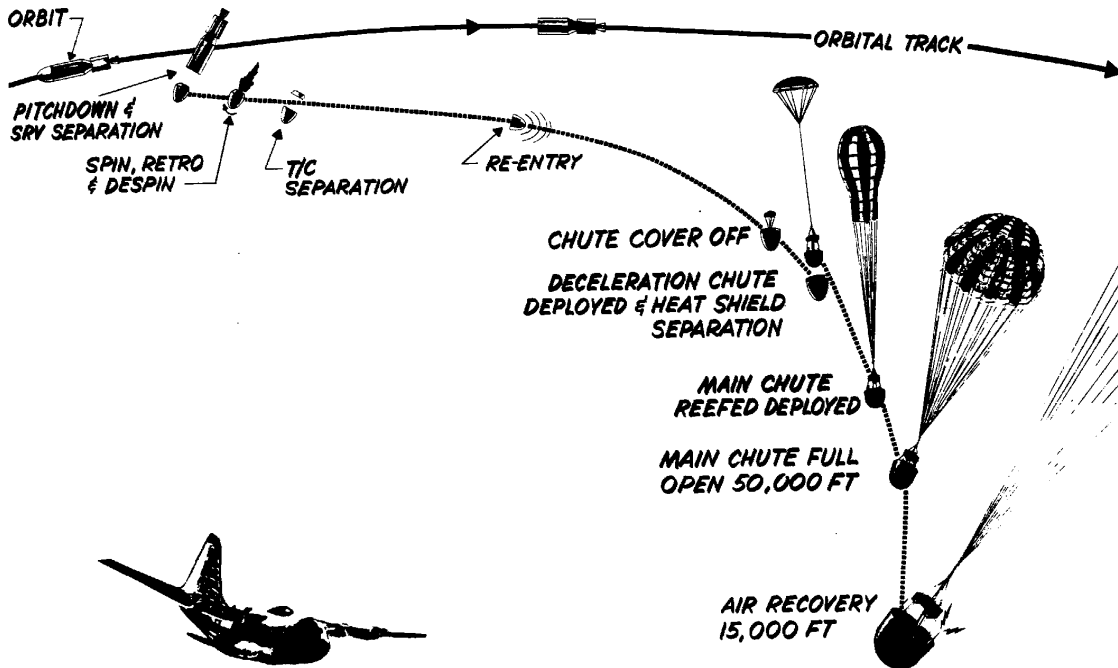

TOP SECRET

3-5

TOP SECRET

25X1

CORONA HISTORY  
 Volume IV

TABLE 3-1  
 SRV SEQUENCE OF EVENTS

Event or Command	Time of Occurrence (sec)	Description	Signal Source		Signature (Requirements)	
			Origin	Destination	Voltage/Current	Duration
Command Reset <sup>1</sup>	Pre lift-off	Relays in programmers and SRV TM are reset	Age	Recovery Program Ejection Program SRV TM	21.0 to 29.5 V/ 2.0 A max	10 sec max
Commands #1 & #2 <sup>2</sup>	Variable	Actuation of Dimple Motor #1	SV	Dimple motors	8.0 V/4.0A	SV controlled
ARM Signal #1 <sup>3</sup>	$T_0 - 76 \pm 0.5$	Activation of SRV TM battery; TM starts operating	SV timer	TM battery squibs	18.0 V/10.4A	Continuous to SV/SRV electrical separation
		Backup timer starts timing after start relay in Recovery Program is actuated		Recovery Program		
		Activation of Recovery Bat #1 & Bat #2 (beacon turn on operating from Bat #1 only); Recovery Program armed; Ejection Program armed		Recovery battery squibs Recovery Program Ejection Program		
ARM Signal #2 <sup>4</sup>	$T_0 - 76 \pm 0.5$	Activation of Recovery Bat #1 & Bat #2 (beacon turn on operating from Bat #1 only); Recovery Program armed; Ejection Program armed (above events redundant with Event #3)	SV timer	Recovery battery  Recovery Program Ejection Program	18.0 V/8.0 A	Continuous to SV/SRV electrical separation
Transfer Signals #1 & #2 <sup>5</sup>	$T_0 - L.0 \pm 0.5$	Actuation of Dimple Motor #2; Activation of Ejection Battery #1 & #2	SV timer	Dimple motors ejection battery squibs	18.0 V/9.0 A	Continuous to SV/SRV electrical separation
	$T_0$ (for SRV)	SV/SRV electrical disconnection (Ejection Program starts $T_s$ timing)		IFD #1 squibs	SV controlled	
	$T_0 +$ (later)	SV/SRV mechanical separation		Adapter pin pullers	SV controlled	
Spin Signal ( $T_s$ ) <sup>6</sup>	$3.4 + 0.3$ after electrical disconnect	Spin initiated (Ejection Program starts $T_r$ timing)	Ejection Program	Spin squibs	8.0 A per ejection battery	10 ms min
Retro Signal ( $T_r$ ) <sup>7</sup>	$T_s + 7.55 \pm 0.45$	Retrorocket ignition (Ejection Program starts $T_{os}$ timing)	Ejection Program	Rocket igniter	4.0 A per ejection battery	40 ms min
Despin Signal ( $T_{ds}$ ) <sup>8</sup>	$T_r + 10.75 \pm 0.54$	Despin initiated (Ejection Program starts the jettison timing)	Ejection Program	Despin squibs	6.0 A per ejection battery	10 ms min
T/C Jettison Signal <sup>9</sup>	$T_{os} + 1.50 \pm 0.15$	Guillotines actuated to release T/C-Forebody attachments; T/C capsule electrical disconnect	Ejection Program	Guillotines and IFD #2	10.5 A per ejection battery	20 ms min

25X1

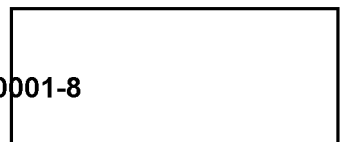

TABLE 3-1 (CONT'D)  
 SRV SEQUENCE OF EVENTS

Event or Command	Time of Occurrence (sec)	Description	Signal Source		Signature (Requirements)	
			Origin	Destination	Voltage/Current	Duration
<sup>10</sup> G Switch closure	3G increasing acceleration	Recovery Program timing circuits energized	G Switch	Recovery Program	Contact closure	Variable
<sup>11</sup> G opening	3G decreasing acceleration	Recovery Program timing started	G Switch	Recovery Program	Contact opening	Variable
<sup>12</sup> Parachute Cover Ejection Signal	26.0 ± 1.5 after switch opening	Cover ejection pistons actuated and cover ejected; flashing light on from Recovery Bat #1; Recovery Prog starts; Recovery Program relays reset	Recovery Program	Piston squibs flashing light	16.0 A per recovery battery	20 ms min
<sup>13</sup> Decel parachute deployed (T <sub>2</sub> )	Variable	Decel parachute battery lifted from capsule main parachute; bagline cutters initiated; Forebody separates from capsule	Mechanical events			
<sup>14</sup> Main parachute deployed (reefed) (T <sub>3</sub> )	T <sub>2</sub> + 10.0 (+ 3.0, -1.5)	Main parachute bagline cutters operated; deceleration parachute strips main parachute from bag; main parachute deployed (reefed); reefing line cutter initiated	Pyro delay and mechanical events			
<sup>15</sup> Main parachute disreefed	T <sub>3</sub> + 4.5 (+ 1.5, -1/3)	Reefing line cutters operated; main parachute disreefed	Pyro delay and mechanical events			
<sup>16</sup> Air snatch	Variable	Capsule snatched by aircraft during descent	Mechanical events			
<sup>17</sup> Water impact	Variable	Capsule impacts				
<sup>18</sup> T/C Jettison Signal from Backup Timer	(180-205) + 40 secs after ARM Signal #1 (Event #3); max recovery bat activation time is 25 secs	Guillotines (4) actuated to release T/C - Forebody attachments; T/C-capsule electrical disconnect (above events occur only on malfunction of Event #9)	Backup timer guillotines and IFD #2		10.5 A per recovery battery	30 ms min
<sup>19</sup> Parachute Cover Ejection Signal from Backup Timer	(1500-1525) + 30 secs after ARM Signal #1 (Event #3); max recovery bat activation time is 25 secs	Cover ejection pistons actuated; heat shield released (above event occurs only if Event #12 has not occurred)	Backup timer (thru Recovery Program)	Piston squibs	16.0 A per recovery battery	20 ms min
<sup>20</sup> Search and retrieval	Variable	Beacon and flashing light operating				10 hours after ARM Signal #1
<sup>21</sup> Sink	48 to 96 hours after water impact	Capsule sinks (occurs only if Event #20 is not successful)	Salt water galvanic action in sink valve			

25X1

CORONA HISTORY  
Volume IV

The following is a summary of selected events of the recovery operation:

A. The separation sequences of SRV A and SRV B are similar except that A to B transfer precedes the SRV A separation, and the fairing ejection precedes the SRV B separation, see Figure 3-5. Both events are initiated by the recovery ENABLE command from the AGENA, but the fairing eject pyro circuits are disabled during SRV A recovery ENABLE. SRV A SEPARATE command fires two pyro-actuated pin pullers in the fairing which releases SRV A from the fairing. Four spring loaded pushers in the fairing push on the rim of the thrust cone to eject SRV A straightaway from the main satellite at a velocity of 1.0 to 2.0 fps. Spin-up of the A SRV occurs approximately 3.4 seconds after separation. After ejecting SRV A, the satellite pitches back to the normal nose first flight attitude, returns attitude control to the guidance system, and resumes the normal minus 4 degrees/minute pitch rate necessary to keep the cameras pointing earthward during the B part of the mission. Upon command, the satellite again pitches nose down 120 degrees to the proper attitude for the SRV B separation. For SRV B separation, the second recovery ENABLE command initiates firing of three pyro-actuated pin pullers located on the forward rim of the conic to release the fairing. Three spring loaded pushers eject the fairing forward with a +1.5 fps velocity just prior to the start of the second 120 degree pitchdown. The SRV B sequence is then the same as the sequence used by SRV A.

B. The SRV is spun up to 55 - 65 rpm by the cold gas spin system. Spin-up is performed so that the SRV will provide a stable platform on which to fire the retrorocket, thus maximizing the retro force in the desired direction.

C. The retrorocket drives the SRV aft and down from the orbiting satellite at a velocity of approximately 850 feet per second for a 100 percent load.

D. A residual spin (10 rpm) is desirable for vacuum flight stability. This provides a predictable atmospheric entry attitude while having a minimum resistance to angle of attack convergence prior to parachute deployment. The SRV is despun by a cold gas system identical to the spin system except for a bottle pressure of 2,400 psi. The bottle pressure of the spin system is 3,000 psi.

E. The RV during descent begins to decelerate as the air becomes more dense. This deceleration increases from 0 through 3 Gs, up to a maximum of 10 Gs, at which time it begins to decrease and attains 3 Gs for the second time. When a deceleration of 3 Gs is attained the first time, the G switches close, arming the recovery timing circuit. When a deceleration of 3 Gs is attained for the second time, the G switches open, starting the recovery sequence. In this manner, it is possible to assure parachute deployment at the proper RV altitude and velocity. A representative curve of altitude versus G level is shown in Figure 3-6.

25X1

**TOP SECRET**

**TOP SECRET**

CORONA HISTORY  
Volume IV

SEPARATION SEQUENCE

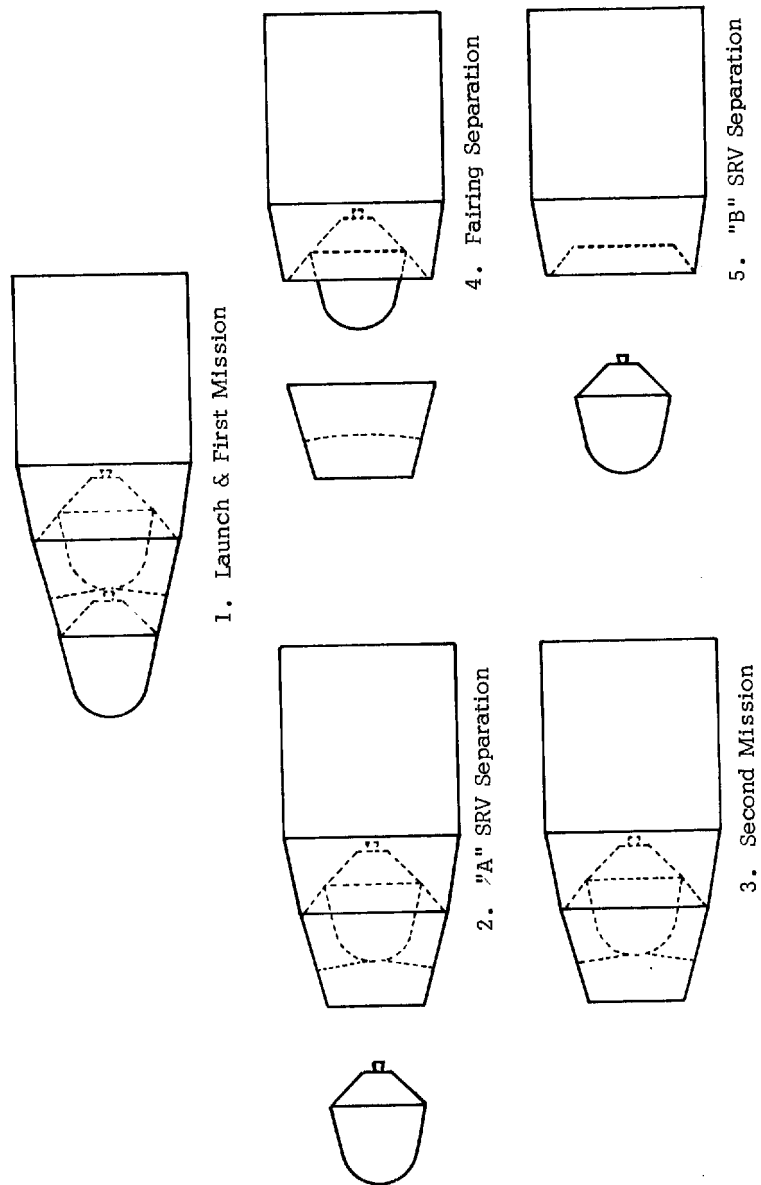

Figure 3-5

**TOP SECRET**



CORONA HISTORY  
Volume IV

ALTITUDE VERSUS "G" LEVEL

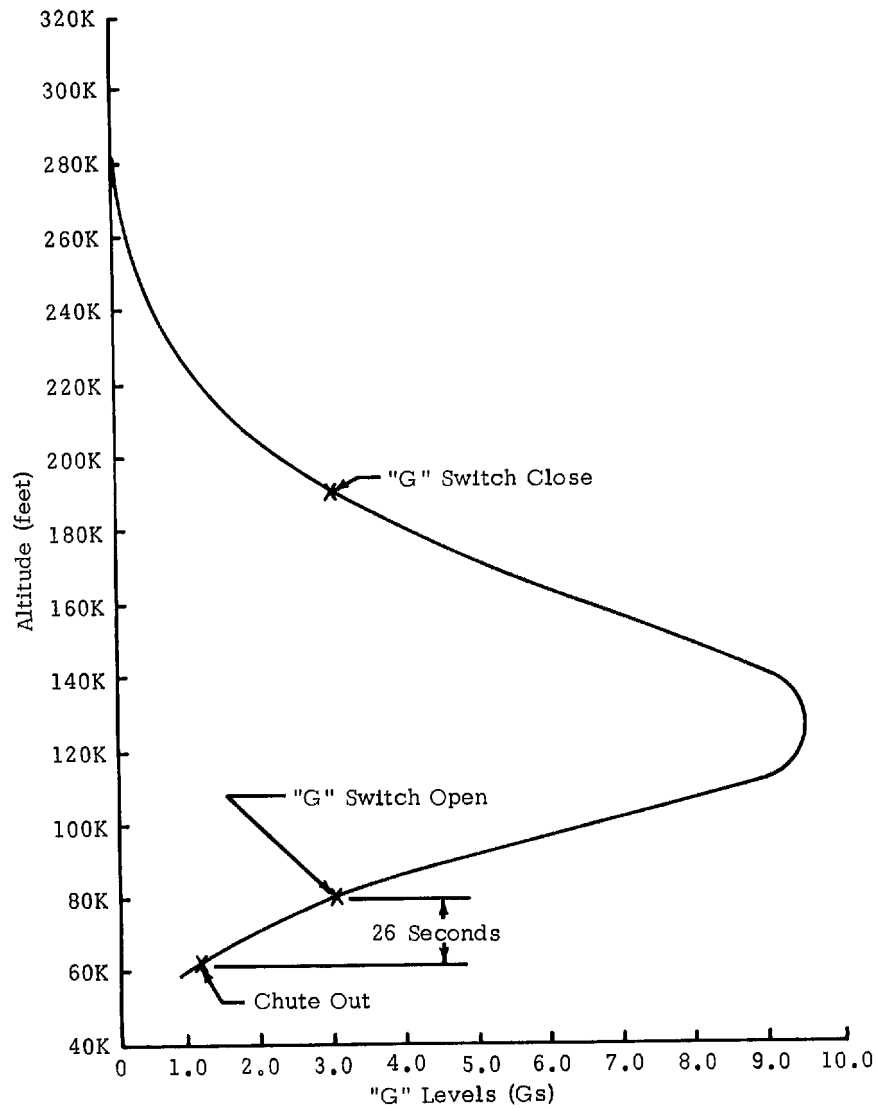

25X1

Figure 3-6

TOP SECRET



~~TOP SECRET~~

CORONA HISTORY

Volume IV

F. Figure 3-7 presents the parachute sequence and nomenclature. At approximately 60,000 feet the parachute cover pistons release the cover. As the released cover is carried away by the airstream, a connecting lanyard deploys the deceleration parachute. The deceleration parachute actuates the bagline cutter, and 10 seconds later the deceleration parachute is released and the main parachute is deployed, but reefed. The main parachute actuates two parallel, four second delay cutters connected to the reefing lines, which initially prevent full deployment in order to prevent excessive loads caused by deceleration. As these lines are cut, the parachute is fully deployed.

G. Normally, the aircraft sights the descending capsule with ample time to perform an air catch. Four Lockheed JC-130 military aircraft, especially adapted for aerial capsule recovery, are used. They are spaced at selected intervals in the planned recovery area at an altitude of approximately 10,000 to 20,000 feet. When the RV has passed through the blackout zone and the parachute has deployed, the aircraft home in on the RF beacon. Upon visual contact, an inspection pass is made by the sighting aircraft. When the capsule has descended to 15,000 feet or lower, a final pass is made during which the capsule parachute is engaged by the aircraft hooking equipment. This sequence and the special equipment used for the air recovery are illustrated in Figures 3-8 and 3-9. A pilot's view and a winch operator's view of a recovery are provided in Figures 3-10 and 3-11. Figure 3-12 shows a successful aerial recovery. Specifications for aerial recovery are 400 to 15,000 feet mean sea level (FMSL), 120 to 131 knots indicated air speed (KIAS), 80 to 3,000 pounds recovery weight, and 1,100 nautical miles recovery range.

H. Should the <sup>capsule</sup> aircraft fail to be recovered by air, the capsule is designed to descend and remain afloat for a minimum of 48 hours. In 48 to 85 hours the capsule will sink due to the action of an electrolytic sink valve located in the bottom of the capsule. During the time interval mentioned and if the conditions of the sea permit, the capsule may be retrieved by "frogmen" from the tracking vessel with equipment parachuted into the impact area. The tracking ship is a naval communications type vessel which functions similarly to the fixed tracking stations.

25X1

~~TOP SECRET~~



Figure 3-7

PARACHUTE SEQUENCE AND NOMENCLATURE

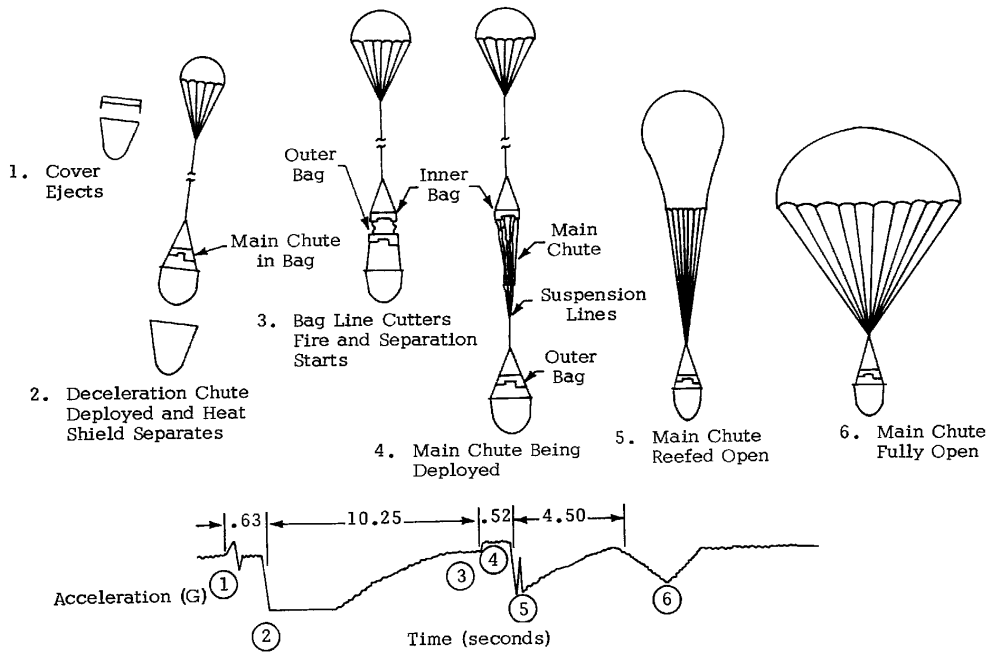

TOP SECRET

3-12

TOP SECRET



Figure 3-8

TYPICAL AIR RECOVERY SEQUENCE

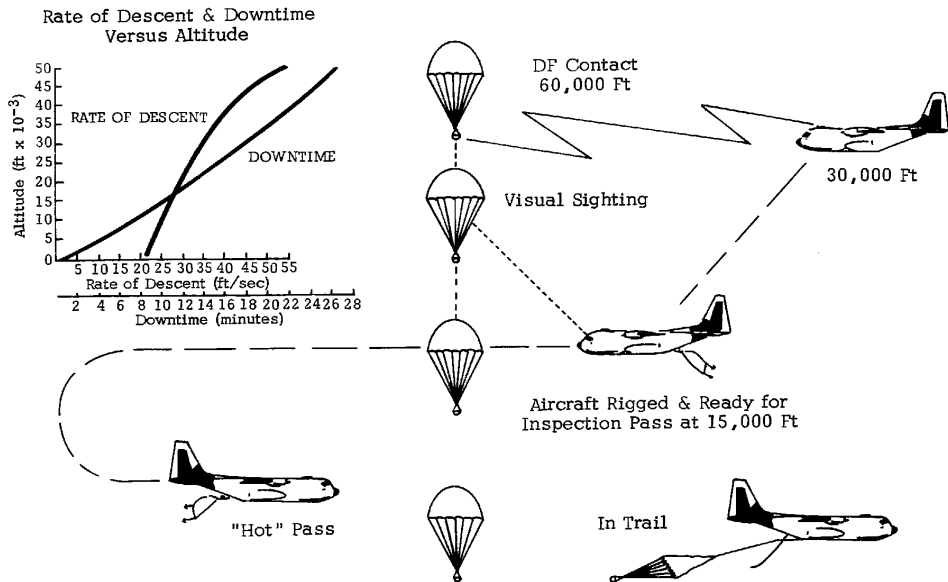

TOP SECRET

TOP SECRET

3-13

25X1

DIAGRAM OF AIR RECOVERY SYSTEM

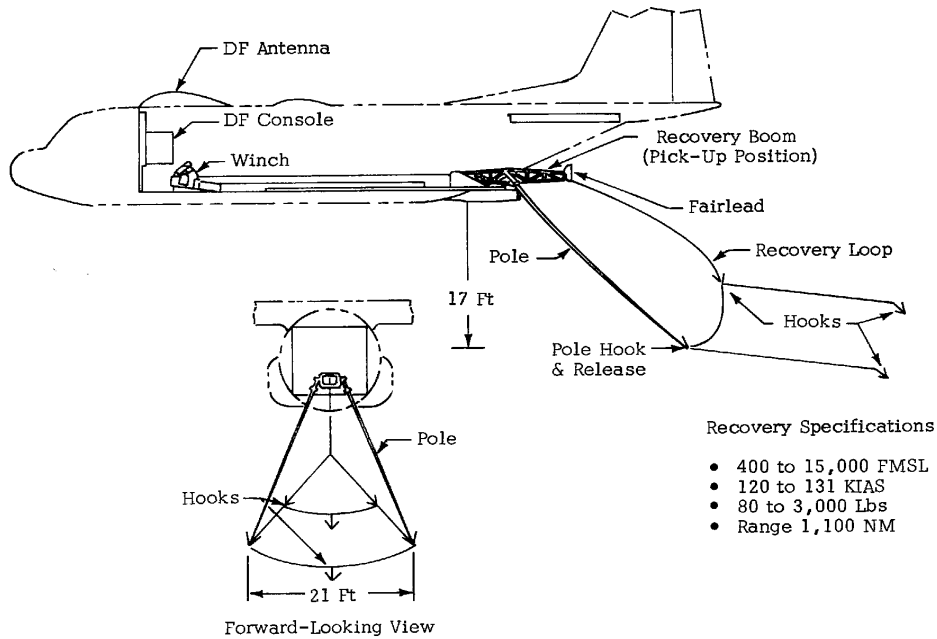

Figure 3-9

TOP SECRET

3-14

TOP SECRET

25X1

CORONA HISTORY  
Volume IV

**TOP SECRET**

A PILOT'S VIEW OF RECOVERY

— Inspection Pass —



— "Hot" Pass —

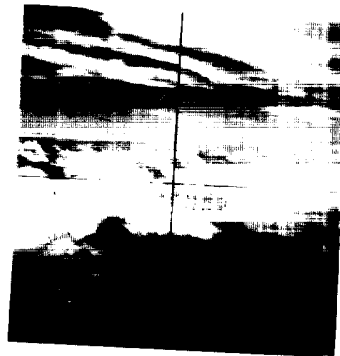

3

2

4

Figure 3-10

**TOP SECRET**

3-15

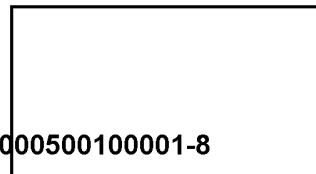

25X1

**TOP SECRET**

CORONA HISTORY  
Volume IV

A WINCH OPERATOR'S VIEW OF RECOVERY

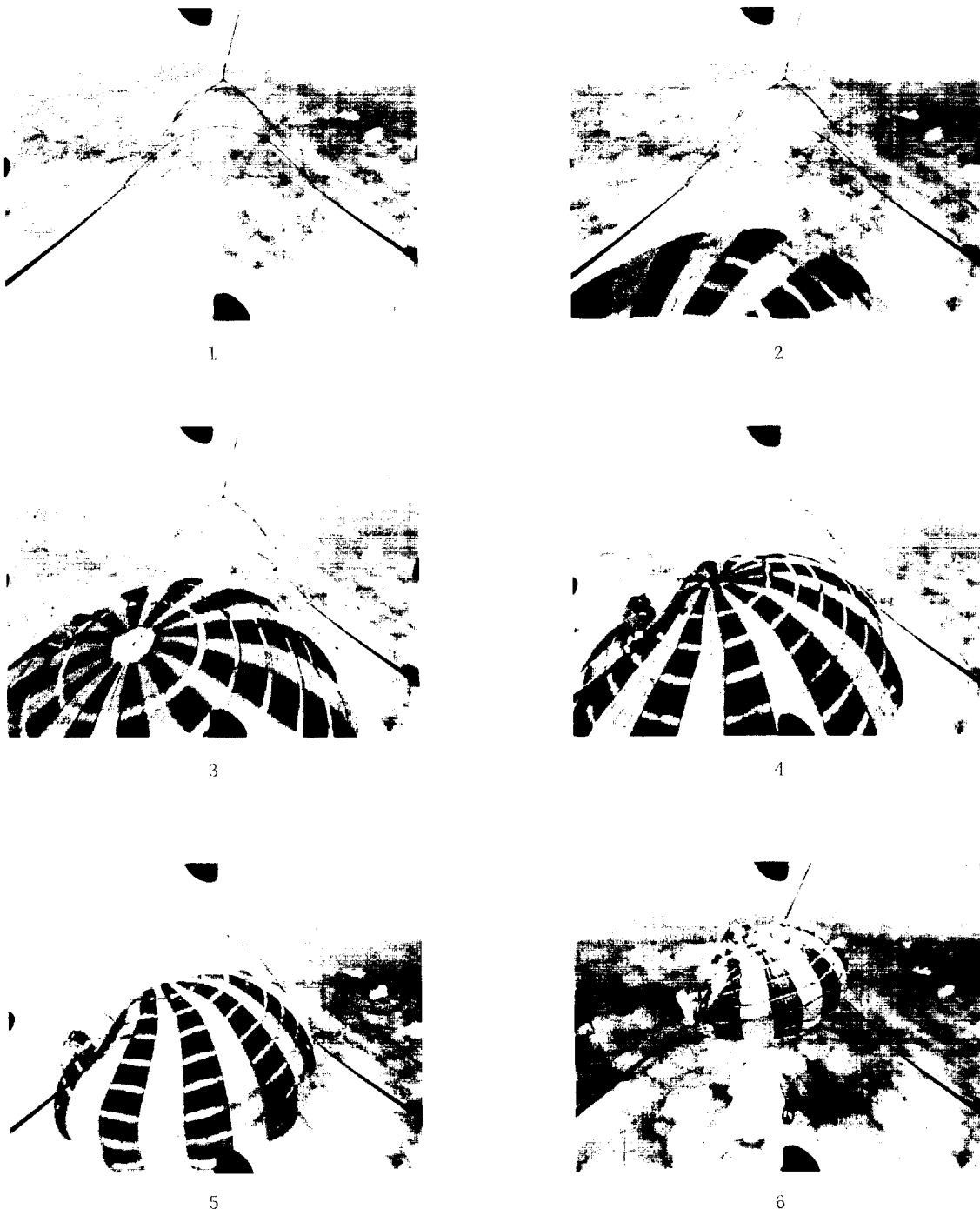
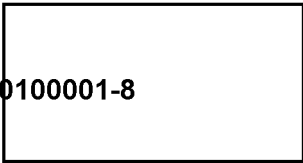

Figure 3-11

**TOP SECRET**



25X1

Approved For Release 2004/07/09 : CIA-RDP89B00980R000500100001-8

ARTIST'S VIEW OF AIR RECOVERY BY USAF JC-130 AIRCRAFT

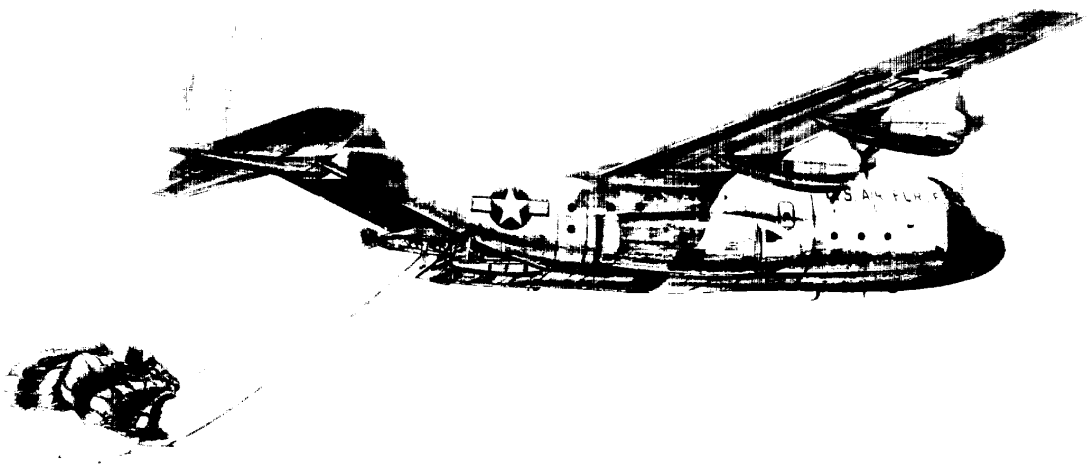

CORONA HISTORY  
Volume IV

**TOP SECRET**

Figure 3-12

**TOP SECRET**

3-17

25X1

Approved For Release 2004/07/09 : CIA-RDP89B00980R000500100001-8

CORONA HISTORY  
Volume IV

SECTION IV

RE-ENTRY VEHICLE PERSONNEL AND DEVELOPMENTAL TESTING

The CORONA Program served as a part of our Nation's national defense structure under four Presidents-- Eisenhower, Kennedy, Johnson, and Nixon. The General Electric personnel involved in the re-entry system development were a major part of the success of CORONA. Credit for the achievement of that success and the recovery of 165 capsules was shared with personnel from Lockheed  Government personnel from the Central Intelligence Agency, the United States Air Force, and the United States Navy; and many sub-contractors. Program managers and project engineers at General Electric for the CORONA Program were as follows:

25X1  
NRO

A. GE Program Managers

I. Clausen	Feb 1958 - May 1959
J. Katzen	Jun 1959 - Dec 1959
E. A. Miller	Jan 1960 - Apr 1961
J. H. Baker	May 1961 - Feb 1972
W. J. Ward (acting)	Feb 1972 to completion

B. Military Space Re-entry Program Managers

Mark Morton	1958 - 1963
Vaughn Nixon	1963 - 1968
Vic Boccelli	1968 - 1969
Ordway Gates	1969 - 1972
Howard Jones	1972 to completion

C. Project Engineers

D. Rossman, R. Singer	1958 - 1959
W. E. Brunschwyler	1960 - 1961
A. A. Little	1959 - 1961
W. J. Ward	1962 - 1968
Al Fiumara	1963 - 1965
Chuck Leonard	1966 to completion
Ed LaMarch (specialist)	1965 - 1969

25X1

~~TOP SECRET~~

**TOP SECRET**

CORONA HISTORY  
Volume IV

Figures 4-1 and 4-2 are pictures of some of the key managers and staff members involved in the development of the re-entry systems for this program. Mr. John Baker, May 1961 - February 1972, was involved in more development on this system than any other General Electric manager. A photograph of some of the members of the early design team is presented as Figure 4-3.

Because of the need for more space and the security requirements involved in developing a satellite capsule that could withstand the conditions of atmospheric re-entry, General Electric purchased a building at 32nd and Chestnut Street in Philadelphia, Pennsylvania. This building was converted from a former Great Atlantic and Pacific Tea Company (A&P) warehouse into the Re-entry & Environmental Systems Division. Figure 4-4 presents a picture "before" and "after" the transformation.

Figure 4-5 presents a series of photographs showing the supervisors on this project and depicting certain phases of separation testing which was being performed at the AP Facility in March 1962.

Figures 4-6 through 4-8 show a sequence of the different tests used to evaluate impact, flotation, and special equipment on the capsule should a water recovery be required.

Figure 4-9 shows two pictures of the Mark V (MK V) satellite recovery vehicle. The upper picture shows the capsule open and ready for functional tests while the lower picture is a completely tested SRV ready for installation into the payload.

Figure 4-10 shows a series of photographs which cover the different phases of parachute installation from the recovery parachute to the extraction bridle to the lowering of the thermal cover.

Figure 4-11 shows a picture of the first object orbited in space and recovered according to plan. This object was the DISCOVERER XIII satellite recovery vehicle. The DISCOVERER XIII was a diagnostic flight without camera and film. The capsule which was recovered from the ocean on 11 August 1960 is on display at General Electric's Re-entry & Environmental Systems Division.

25X1

**TOP SECRET**



**TOP SECRET**

CORONA HISTORY  
Volume IV

EARLY GENERAL ELECTRIC PROGRAM MANAGEMENT PERSONNEL



Jack Katzen, Program Manager from June 1959 to December 1959

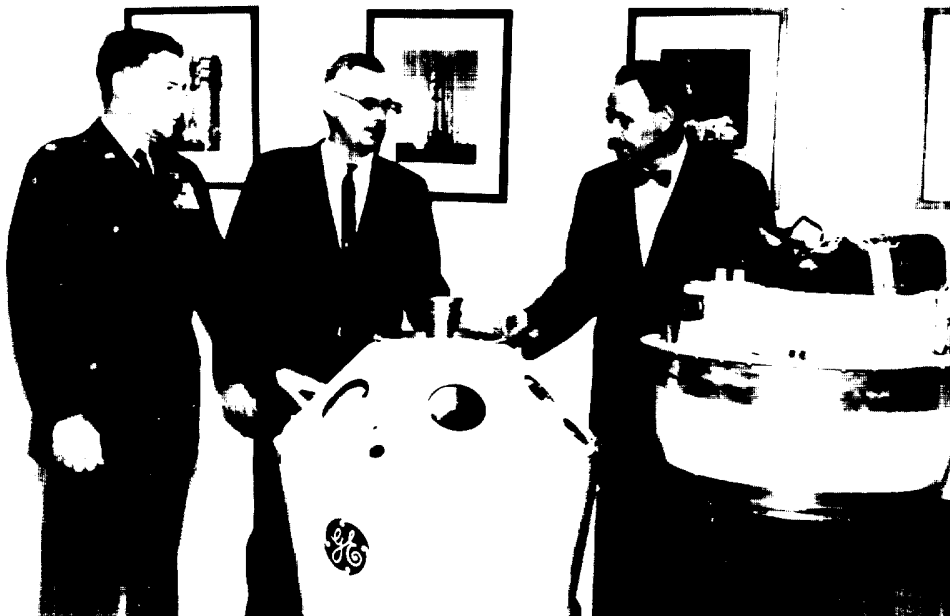

Ed Miller (center) Program Manager from 1960 to 1961 and M. Morton (right) General Manager for Space Systems from 1958 to 1963 Discuss Re-entry System with AF Representative

Figure 4-1

**TOP SECRET**



CORONA HISTORY  
Volume IV

GENERAL ELECTRIC PROGRAM MANAGER 1961 - 1972



Program Manager John Baker (right) with Rita D'Aquino and Charles Leonard

Figure 4-2

**TOP SECRET**

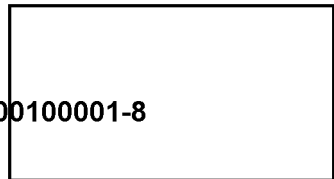

~~TOP SECRET~~

CORONA HISTORY  
Volume IV

MEMBERS OF THE EARLY GENERAL ELECTRIC DESIGN TEAM



Dick Heffelfinger, Bob Spatz (Air Force), Ken Walker, Clarke Allen, and Al Little

25X1

Figure 4-3

**TOP SECRET**



CORONA HISTORY  
Volume IV

THE "BEFORE" AND "AFTER" OF GENERAL ELECTRIC'S NEW HOME  
FOR ITS RE-ENTRY & ENVIRONMENTAL SYSTEMS DIVISION



"Before"



"After"

Figure 4-4

**TOP SECRET**

~~TOP SECRET~~

CORONA HISTORY  
Volume IV

25X1

SEPARATION TESTS AT  ADVANCED PROJECTS (AP) FACILITY

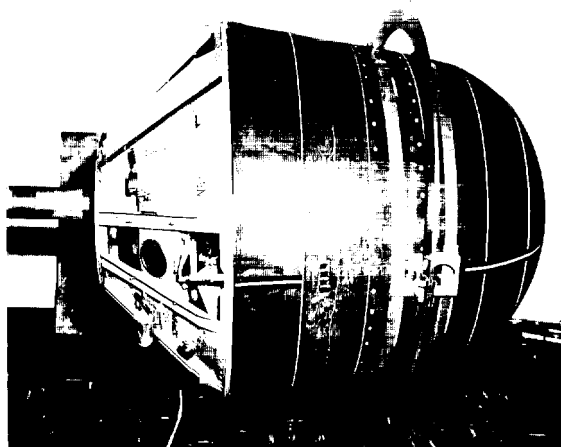

SRV Complete

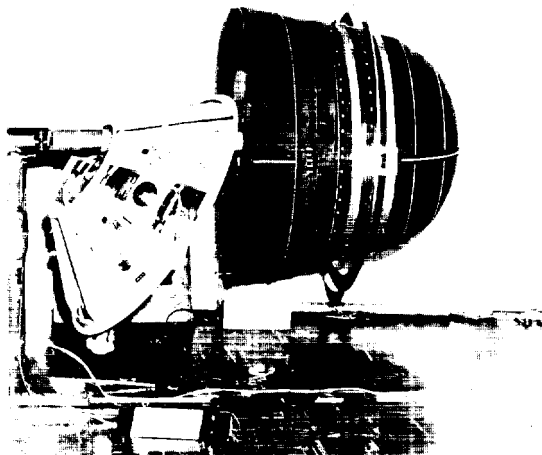

Thrust Cone Ejected

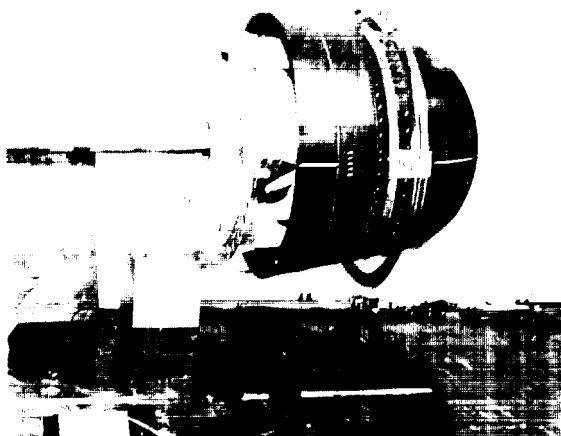

Parachute Separation



AP Supervisors

Figure 4-5

**TOP SECRET**

25X1

**TOP SECRET**

CORONA HISTORY  
Volume IV

WATER IMPACT TESTS AT SANTA CRUZ IN SEPTEMBER 1962



Aerial View of Site



Preparations



Capsule after Drop



Examination for Damage

Figure 4-6

**TOP SECRET**

4-8

25X1

TOP SECRET

CORONA HISTORY  
Volume IV

FLotation TESTS OF A J-1 SWINGDOWN BALLAST AT THE ADVANCED PROJECTS (AP) FACILITY



Ready to Drop

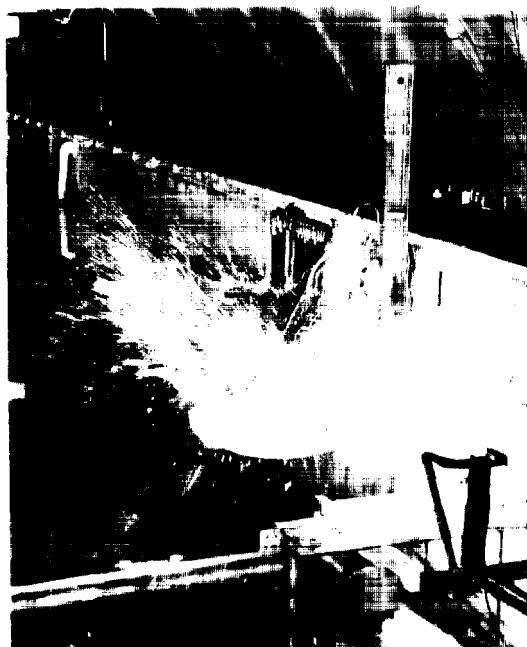

Water Impact



Ballast as Seen from Underwater



Flotation is Successful

Figure 4-7

TOP SECRET

~~TOP SECRET~~

CORONA HISTORY  
Volume IV

OCEAN FLOTATION, BEACON, AND FLASHING LIGHT TESTS OFF CAPPOLA



Capsule Orientation in the Water



Reeling in the Capsule



(l-r) T. Whitehurst, K. Perryman, A. Garza, L. Price



Careful Examination of Capsule

25X1

Figure 4-8

**TOP SECRET**

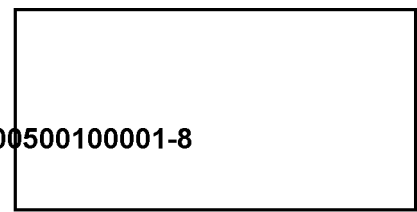

PARACHUTE INSTALLATION

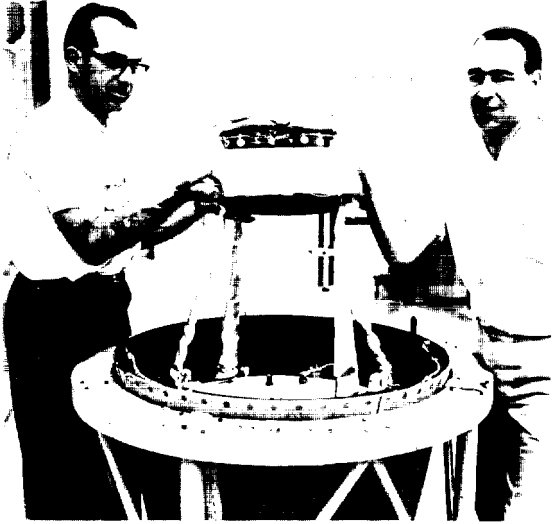

R. Kieth & A. Garza Installing Recovery Parachute

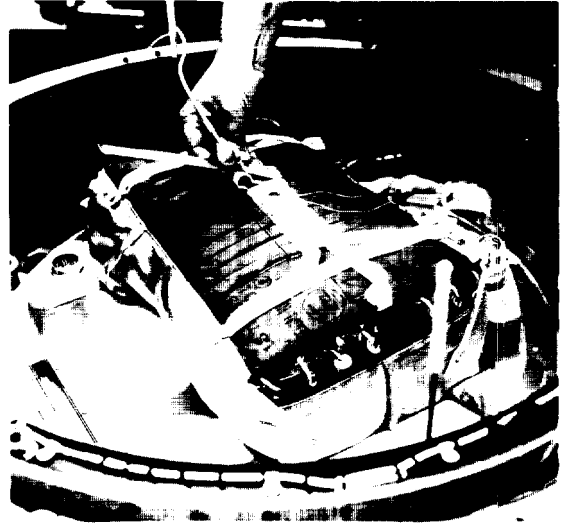

Extraction Bridge Installation

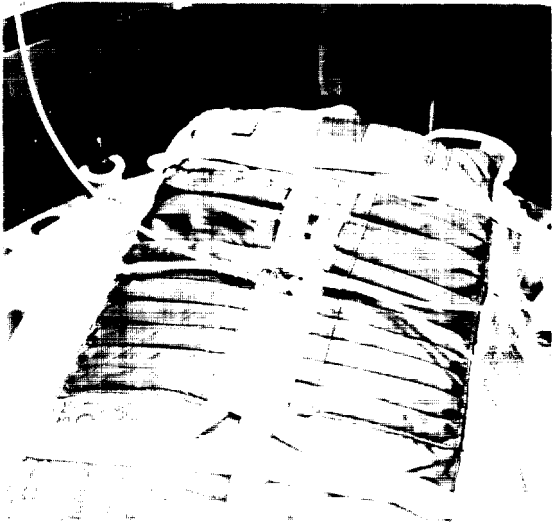

Parachute Installation Complete

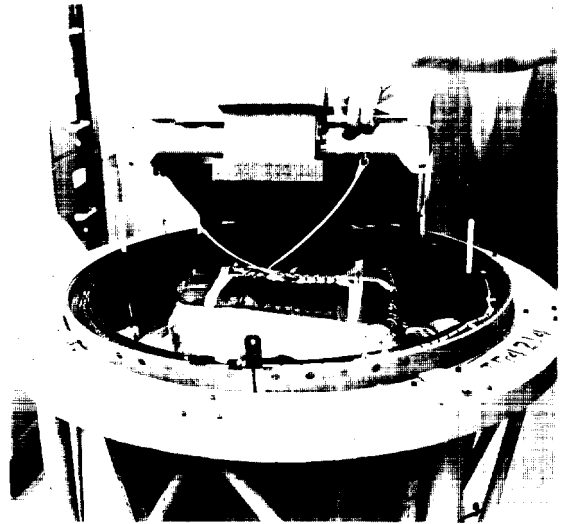

Thermal Cover Installation

25X1





~~TOP SECRET~~

CORONA HISTORY  
Volume IV

DISCOVERER XIII CAPSULE



On Display at General Electric's Re-entry & Environmental Systems Division

ILLEGIB

Figure 4-11

**TOP SECRET**

