

SECRET

TRANSCRIPT

REMOTE VIEWING (RV) SESSION CC63

TIME

#66 This will be a remote viewing session (edited for security).

PAUSE

It's time now to relax and concentrate and focus your attention on the target for today. Focus your attention on the area in the vicinity of

SG1A



Relax and concentrate. Focus your attention on the target for today. On the area in the vicinity of

SG1A

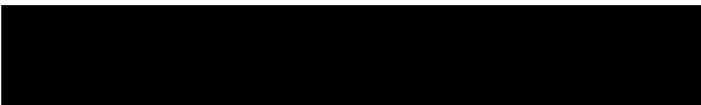

Simply relax, relax, concentrate and focus your attention. Move your awareness on the target for today and describe it to me.

PAUSE

+03 #31 Got some sort of a overpass or over hang...a very large structure, I think. Expansive, but I can't... I feel...a tunnel or underpass is separating what looks like two portions of a structure. One at right angle to the other...portion. The overhang was slanted and had ribbon ridges in it...or lines and it appeared brown or dark brown hued..uh..

#66 All right focus on the target without recording so that you may give your full attention to the target for a moment. Do so now.

PAUSE

+07 #66 Now! Report your perceptions to me.

SECRET

~~SECRET~~

- +10 #31 I had a..uh..feeling of(mumbling) structure (mumbling). I keep seeing something very long like standing (mumbling) overhang. To my right is..uh..same kind of a structure (mumbling) like a tunnel (mumbling). This thing is very long (mumbling). Essentially (mumbling) sides go up and down and under it. Also have tingling feeling..uh..but, standing inside of this tunnel ..uh..in the main, or in the wing that extends out.. (mumbling) had this feeling of a great hollowness inside, an emptiness like this thing is made to look like something else and really has..there's nothing in it. It's made of wood, but supposed to look like it's made of something else. It looks very unfinished up close. The edges of the cut....the doorway's cut are very thin, as though there is no jam around it and no..nothing inside.. uh..I feel all raw wood and a shell is what I feel.. from above it looks as though a long access of structure disappears as though it's nestled back in a hill and is partially covered by a hill. That is a skinny part. On the right side of that skinny part is the thing I call an overpass. It sticks over and connects itself to a larger part of the structure, as though vehicle would drive in under this roofed overpass and continue on between two separate parts of the building. But, they could be seen between the buildings. But, under the overpass they could not be seen.
- #66 How long is this passageway between buildings?
- +12 #31 At first I had a feeling it was a very long..uh.. no, I understand your question. The building is very long. I had a feeling of several hundreds of yards but the passageway between the buildings is only 35 or 40 feet long and the buildings themselves are only 35 or 40 feet apart all along the passageway. All along the driveway, or whatever it is.
- #66 Ok. What is your position of observation, at the present time?
- #31 Now I am looking down at it.
- +16 #66 Describe the terrain adjacent to the structure.

~~SECRET~~

~~SECRET~~

- #31 I have a feeling it's a hill into which this thing is dug along this long access. The hill on my horizon as being looking past the building at the hill...it appears high on the right side much more....much more pronounced...shaped almost like a buttress and then tapering slowly down to the left into a ridge line which proceeds of... turning around and looking away from the building I'm getting a feeling that it is on a slope away from this...like in the foothill of the mountain but, it slopes away off from the...into a...on the long sloping run down into a valley..uh..a shallow valley some distance from me in the distance ...on the other side of this valley possibly one mile and a half I see another feeling of a ...I want to say another sharply rising piece of terrain rising up. I want to put another hill over there. The hills seem treed..uh..but the slope..uh..in this area.. seems untreed, unforested until it curves away from my line of sight, and gets down into what would be the valley. It seems to turn greener in the cliff down there. Whereas, here where I am is rather brown and drab as though, I'd say, grassed hillside. It seems open to me. No trees in this immediate area.
- +21 #66 Focusing your attention once again on the building describe its color to me.
- #31 It.....a darker charcoal appearing on the top. (Mumbling) size of the roof. Beneath the roof line it is a lighter gray or a dark sand color. It is two-tone..uh..
- #66 Focus your attention now on the activity at the target area and describe the activity to me.
- #31 I..uh..although this thing looks skeletal, or something, standing under the covered arch, or the covered (mumbling) or whatever, looking at the downhill side, away from the hillside..uh..saw in interior of the building, somewhere a..(mumbling) maintenance, scenario with some sort of a ...the rear of a large track vehicle in the building with men crawling on the dock side and working on it on the outside...and..uh..turning around now, at this vehicle and looking back I have the feeling of a large bay containing..uh..a significant number of track vehicles.
- +26 #66 Describe the comparative size of these vehicles.

~~SECRET~~

~~SECRET~~

#31 They are..uh..(mumbling) wheeled...tread is about nose high on this man and no cupola...it's a straight turret...it's about upper chest high on a man. There's a ...a muzzle break thing on the tube. They all appear about the same size. There may be four or five here in a row pointing ...it's ...my left...it would be my right at the original start point looking the other way.

#66 What is the nature of the work done on these vehicles?

#31 Uh...I don't have any feeling of anything other than maintenance...let me look for a minute.

#66 You may answer this question by describing the actual activity of a worker.

PAUSE

+30 #31 I'll pick a worker. When I started I had feeling of a guy handing something down into the turret and that work...work was being done on the left side of a ...of the gun mount...forward of the gun in..possibly the gunner's position on a panel of dials and gray... , gray, sand gray...the equipment rack located in the forward and left side of the tube. Like a part...I had a...I had like a part being plugged in and being hooked up. A small thing. Hand size.Let me find another sample.

#66 Fine. I will wait.

PAUSE

+37 #1 Had definite feeling of..uh..one Mongoloid (mumbling) person. I'm getting various shots of bogie wheels off and being replaced...and, one with engine compartment open...rear engine compartment...and another one was some sort of a back compartment of some kind dropped down and for a moment, I thought I had one located on a trailer, flat bed, trailer...as though moved by roadbut, I don't get any specific one-of-a-kind or some special type shot of any one major thing.....similar with all of them. That's all I got.....sorted.

#66 Ok. Fine. Focus your attention now on this area continue down beyond these vehicles...describe what's down beyond these vehicles.

~~SECRET~~

~~SECRET~~

#31

I'm looking on the starting direction, past vehicle I..uh..feel that the back of this...this open bay area is walled off, and...uh...has a sort of a..uh..junk racks...I mean a..uh..open bay window type of parts type of a place. But just past the last vehicle it's as though if the vehicle made a right that that goes around a corner and goes through another big ..uh..gate in the wall...just an open passageway and proceed to other points somehow. I don't know where I am within the whole building now, but I have the feeling of a...I'm standing at this open cut out in the wall. The in tank the in tank is to my right. There's a wall there, but I have the feeling on the other side of the wall is light coming down. Possibly..uh..some sort of an open yard of some kind. But, that in the past I am.....I would drive along under an overpas.....an overhang by this court yard. By it's open light area and I can continue down a long tunnel. I see a light at the end of the tunnel. But, peculiarly, it is only...it is only a one-way trip. It's only wide enough for one ...for one tank. I'm going by wooden upright post on the right and a wall on the left and I'm going by there and it's as though down in the other part of the building there are more servicing stalls...stalls or bays for other types of work or something.

+40

PAUSE

There is some sort of a low rail along that court yard. I call it a court yard, but it's not a court yard. It's just like a hole between two structures that I didn't see before. But, I feel that there is light in there that is not covered over like the rest of the structure.

PAUSE

#66

I'd like to call to mind now, a comment that you've made previously, and ask you to focus your attention on that area again and explain further your impressions. This impression is concerning the structure and that it's made to look like something else.

PAUSE

#31

It's..uh..it looks like a barns (phonetic) or something...or...my impression then was that it looked to be a more substantive construction than it really was and that it wasn't a building complex with walls and with doors and jams and rooms inside but, it was essentially a shell frame which covered

~~SECRET~~

~~SECRET~~

+46

alot of open space rather than alot of closed in spaces like a regular building would do. The outside of the place is strickingly funny and that may have caused me to say it. It's...I had this definite feeling of ramshacked, rumble, dumble down wood while inside it's really got something going on in it different than would appear from the outside, it's all.

#66 All right. Now, focusing your attention inside once again looking at the vehicles. Do you recognize these vehicles?

#31 I would say they are the T-55 type.

#66 Tell me now, the particular components of your perception which leads you to make that statement.

#31 Rounded..uh..sort of..sort of..flattened, round, low silhouette (mumbling) muzzle break, tubes, this feeling of large tubes down about one meter down the barrel...thing sticking out the front of it...and..uh..general size in contours of the M60 with about one foot taken off of each...one foot taken off the height of the chassie and about another foot flattened off the top of the turret. Lower slung than ours, but not super low. Little more squat looking. Around fender in the back.. I don't know what else. Different feeling of a double hatch, rear end compartment. I don't even know if that is on a 55.

#66 Focus your attention solely on the first vehicle in mind now.

#31 Yes.

#66 Scan the vehicle for nomenclature.

+50 #31 It has a..uh..a..uh..five point star. I meant to mention this earlier, but, what I was looking at before, I had the feeling of a five point star on what would have been the right side of the cupola. Now, let me look at this thing. I'm not getting anything more. (Mumbling) put another star on the forward top of the chassie end of the barrel, on the slanted part between what appeared to be two raised things like light frames or something. They're round and they stick up...they stick up on inside of each fender.

~~SECRET~~

- #66 Describe the color of the vehicle.
- #31 Is a brown gray. It...not brow, more grayish.
- #66 And the color of the star.
- #31 Red.
- #66 What is the gestaltic nature of the personnel working on the vehicle?

PAUSE

+55 #31 I get more...they are...more that they are..uh.. Russian. But, that they are Mongolian..uh.. Mongoloid. At least one. But, I don't know. I.. at least one Mongolian. They're Mongoloid, They'll never draw. But, I don't have..uh..I don't know. I feel like I'm in some Soviet province somewhere. A frontier province or something. I don't feel like I'm in the heartland. Feel like I'm out in the semi-tactical forward area frontier type..repo, depot, or something.

#66 Tell me the data which you perceive that makes you say that these people are Russians.

PAUSE

+57 #31 I don't know why I said that. I have perceived no actual reason why I should say that. I don't even know what to look for to see why I said that.

PAUSE

#66 Describe the workmen to me.

PAUSE

#31 Has dark hair. Has (mumbling) eyelids. Ruddy complexion. Wide face. High cheekbones. 5, 6, 5, 6,..uh..size. Wearing a..uh..brown...some little brown kaki, dark kaki..uh..pants. I see some sort of a parka (mumbling)..wouldn't mean it's cold, but, even inside, but no gloves, but a parka type thing with a...which is a darker brown. Padded. Uh..and has a fur..uh..looks almost like a old..uh.. flight jacket..it's..uh..fur colored type thing. Inside of the collar, I want to say it's got fur on it, but I don't have the feeling that it is cold inside so much as it's cold outside.

~~SECRET~~

#31 I wanted to put a (mumbling) cap on him. The flip up classic..uh..ear flaps and everything.

PAUSE

+63 #66 I have no further questions about this target. Now, I would like to give you the opportunity to add anything that you would like to add.

PAUSE

#31 I don't have anything.

#66 All right. I'd like you now to draw the perceptions that you have had.

#31 Ok. The first thing I had was a image of some sort of an entrance way ...that is what I called an overpass or underpass. It's like a drive through place. Doing this in magic-marker so I don't.....

Ok. It was like the building wall. The little black square here is the underpass thing. Like that. Ok. What we end up with...the roof line... here..the thing that was so hard to describe is.. you know what McDonald's roof line looks like... it's a roof line like that. Ok. It jets out.. vertical...has these lines into here that I'm drawing in. Ok. Then, it goes around the dam corner. This is sort of a quasi aerial view over here. Ok. This is the first view I had. And, it's got this slated exterior. At least the place I was had it. Like that. Ok. This thing goes on. Now, here is the thing that I referred to as being the overpass. We'll bring it into here. Ok. And the building goes off like that. And this is this building here, which I have the feeling is in a hillside, ok, but dug back in a hillside. I'll do it.....all right. So here is the overhang continues on.....and this separate thing....which is a separate building thing.....and there is..... my first impression was that it was a solid flanking piece, ok. Like that.

#66 The term overpass.....

#31 is this thing here.

#66 that we generally use to be something that goes over a highway or freeway. You use that word now to describe an area that is sheltered.....

~~SECRET~~

~~SECRET~~

#31but opened.

#66 But opened.

#31 Passed through. Instead of an overpass, it's like an underpass. But, I used the first word that came into my head. You know. Because I was just getting on target.

#66 Sure. Ok. It's an open space but covered over the top.

#31 Right. Inside of a building or structure of some kind. I'll do another view of that.

#66 Ok. Draw me an arrow there to show that...where that black thing is...that kind of like an entrance to the building or...

#31 Right. I had the feeling it was like opened all the time. It's just a hole in the wall. You can go right through it any time of the day. I didn't get the feeling that there was any kind of a thing that closed it off or anything. It's like two separate buildings connected by a roof. That's all. That's what I'm trying to talk about by overpass. Ok. Entrance, and I'll call it overpass in quotations for correlation to the tape. All right. It looks like this on 2.

Taken from the direction of the arrow it would look like this. Actually, those things should go to the other side. Those are the slats, ok. This goes over here. That's that funny.....God there was really a weird rivulated roof.....if I can describe it as rivulated. It was like eroded. It was like the roof line had grooves in that were vertical. Ok. Like this. All right. And, then here into the present foreground is that, ok. And, there's a recline along there like that. This building just disappears into the distance all the way back. Ok. That's the right building here, just disappears into the distance and here in the foreground, left, is the other building, ok.

#66 So, draw me an arrow that says I'm looking down entrance way, or something.....

~~SECRET~~

~~SECRET~~

#31 Looking under a (mumbling). Now, this thing is... the darkness...I'll draw the darkness with a shadow. Unfortunately, this is only really two dimensional here, and it shouldn't have been. Uh..it's shadowy in under there because it's in.....

#66 How large is this?

#31 This is the 35 to 40 feet across thing.

#66 Ok. I can drive in there as opposed to walking.

#31 Right and this is the right building...looking... I want to call this...looking between two buildings under the underpass...for lack of a better word.. ok..

Now, 3. Let's say I moved in a little bit closer in under this overhang. Oh, Wait a minute. There's one thing I want to put on..and this is the ...this lattice shingle feeling of the wall, ok.. and here's all shingle feeling of the wall..like this..and..that..you know..I had the feeling you could..like see the overhanging pieces of..... the overlapping pieces of wood along the edge of the building. Like that. You know how you lay one and you lay another piece of wood on top of it.

#66 Is that lap work?

#31 Well, it's not lap work. It's just normal wood construction. You know. So that the water doesn't fall in the crack. It runs off. It doesn't fall in the crack.

#66 Ok. Overlapping wood piece.

#31 Right. Wood construction. Wood siding. Overlapping wood siding. I guess. All right. Moving into close and in under this overhang is this feeling on the left side here. I'll draw a cut-away. On the left side is this overhang, ok. It's got these funny rivulets in it. Rivulet shape. Then here's the wall. Like that. All the way down. This isyou know.....and here is....I had the feeling it was just a standard 2 by 4 frame piece of wood and looking inside this sucker now, this disappears off into the horizon. Ok. Drawing this thing is really weird. It's just a bare wall. It's like ...I remember....I said there's nothing around it.

~~SECRET~~

~~SECRET~~

- #31 It's just like somebody took a buzz saw, built a house.....a wooden house...and took a buzz saw and cut a big hole in the wall. You know. You're standing there and here's this raw wood. I mean there's no molding there's no nothing there. It's just raw wood. You're just looking at this raw wooden edge and, that's when I got the feeling that this thing was covering something. It wasn't a permanent type of building, concrete and cement, or anything like that. That it was just this wooden frame building that had been constructed to cover something, and this thing here was this large bay which is down here on the left of two, ok. Which, when I first looked at it was just open. I had this feeling of open darkness back in there, ok. So number 3 is looking....looking to the left ...inside the overpass, ok. This is the edge of the wall.
- #66 About how long this passageway continues? This covered passageway. About how long is it?
- #31 On one it's not very big. So going back to one to answer your question I'll say that this is maybe 60 feet, ok.
- #66 This area in here then becomes open.
- #31 That is open, right. That is open area in there.
- #66 And, how long are the buildings themselves?
- #31 Well, I didn't get a feeling. I can show you an aerial of the building. I had the feeling at the top of one, this building that seemed to go off on the back of the hillside and was almost dug into the back of the hillside is this feeling....very, very close to the back of this hill and skinny. You know. It was abnormally skinny. It was as though there was more of it hidden away from my sight because it was only a little skinny thing... that was the thing that was a couple of hundred meters long....that's the thing that felt to be real big, real big. When I was first going into it.....I'll depart now....ok, just for a minute. When I was first going into it....four is my second impression. These things came later. Two and three came later. Four is my second impression of this weird magical overhang building edge.

~~SECRET~~

~~SECRET~~

#31 Overhang there. Way down into the distance there is overhang and here is building coming back into the foreground. Like this. I had the feeling that the building onappendage....the one away from the hillside is shorter than the one along the hillside. So I'll show it like this. And, this is the overpass seen from different....seen from other end not different end....other end. Like that.

#66 So, you're telling me then if I went...when I go.. if I was to zip way down the other end of this and turn around and look back that's what I'd see.

#31 Absolutely. If you were to go to the far left end of sketch one and look then you would see this type of a view.

#66 These two buildings never come together again down there.

#31 No, no. They're opposite all the way down.

#66 Tell me a little bit more about this...this thing that's close to the mountain. Can you tell me whether or not it is part of the mountain or is not part of the mountain?

PAUSE

#31 I don't know. I'll tell you one thing about it that's not voiced on the tape. That is when I was about in the situation of viewing the sketch two, and as I moved in under in order to go to sketch three, ok, I had the distinct feeling that the long skinny building to my right turned into a loading dock, ok. A covered loading dock. I had the feeling of a..that it was..that it was a platform in there....was platform and wood holding up the risers, you know...wooden posts. So I'll draw that. I was going to draw that as a different...in other words, here...that this was a ...I don't know how to describe it...that had a dock on it. Is what I mean. I was going to include but, I'm only talking about where I was, what time. This feeling here. Ok, here. Let me see...let me draw 5. This thing became very big. That's our overpass..oh, our overhanging roof ...ok.. It's not a simple box. That's the problem. The front face of the building became that type of a shape. Having a dock on it, like that. See. I didn't want to put railroad tracks or anything driving in under this ...you know....moving....or road.....anything. So I didn't. As far as I'm

~~SECRET~~

~~SECRET~~

concerned it's just wheat field in under between there, because I didn't not put anything in there. The impression was as though a train would pull up in front of the long skinny building. Would off load stuff onto this loading dock and then drive out. That type of a feeling. Or trucks would pull up in under there along this long building here and would off load their stuff.

This is the roof and this is a loading dock... indentation or....on the face of the building. That is like an alternative right side to 2, going into the background. And in four, on the left side, would be an alternative to the face on four or a secondary impression. Whatever you want to call it.

#66 Ok. I asked you then to focus on the activity of the building itself.

#31 Ok. So 6 then is the interior of at least the first bay then I can draw an overhead, whatever. All right. Here is wall going along like this. That's not going to be right. Let me take another crack at it. Problem using that big marker. It don't let me erase nothing. There is the wall in the back here. Now, as I told you, I don't know where I went. I just sort of boomed...suddenly I saw the...I may have been able to maintain the continuity of movement here, but I'm not too sure of it. I may have zipped to some other part of the building. I had the feeling of this long bay area with...make it a little bit bigger...ok...then another one in the foreground and another one on the right side....facing a wall. Which is that. Like that. Four to five track vehicles was the first impression located along the right side of this big expansive bay area. The feeling was that vehicles would drive in under this overhang into ...would make a left, somehow...you know....presumably it's large enough....would make a left down through another gate area...another gate here on the left side...another big hole and would drive down and would park in bays...like that. Four to five... and somewhere in the back was a...I'll put a window in here. Sort of like a parked servicing bay area. Then the other thing is....there's another one right there. Exit, large. I'll write large exit door... As though the vehicles could be serviced on the right side of the bay and then could be backed out and then could exit the bay going this way rather

~~SECRET~~

~~SECRET~~

than having to turn around and come back out. You know. It's like a one-way street through there. All right. So, the whole feeling of this thing was not....oh, and this is the wall. Now this is an interesting...this is the thing that makes me wonder about whether I was in the same place I started or not to another part of the area or if I'd stayed in that first immediate wall area is because on the outside I didn't put any windows in there. On the inside however, I did. I put...some sort of light emitting, ok....not quite that....like that....along that side, ok. That's about it for that.

Six, seven. Exiting the exit is the way I went. Exiting the back rear exit door ...had a feeling of a..uh..again a dark...how am I going to draw this now....let me figure out where my perspective is going to be. This is very dim through here. This side comes all the way back, ok. This is the light area, here. I had the feeling I was looking in some sort of little court yard. In other words, what I'm saying is there's light coming down in here. But, this is the covered area. It's like a tunnel and, that there might be some more turn-in areas on the right. Similar to the one I just came out of. Pulled in like that with a vehicle. But, it's only a one-way track. It's like once these things....once these vehicles are brought in, they don't turn around and go out the same way. They go and they have to proceed through all this maze until they get out the other side. Possibly several more bays on the right side. I have written it on the side of the wall here. This is some sort of a railing or fence. All right. Now for the long skinny building. I sort of didn't address that...the one you asked the question.

Eight. The feeling I had was.....hilltop and a ridge....and this structure...shaped like that, ok. This line along the back of the structure...the hill back of the structure was very irregular and I could not make out looking at it....I could not figure out if it was a long skinny building or if it was something...had been inserted back into the mountain-side or the hillside, ok. The land rolls away then... and it's gently rolling downward, I'll just say.

#66 Any concepts of roads leading to this building?

#31 No. I'm not saying there isn't any. I just didn't get any; because of the peculiar circumstances of

~~SECRET~~

~~SECRET~~

the whole thing, I was really hesitant to say, you know, to work on any roads in and out, or anything like that, because this weird overhang... immediately an overhang, a passover, or a passunder, or whatever it's....immediately constitutes road.... It could be anything. I didn't concentrate on that. I was working more on the building. Uh... ok, I'll draw you an overhead.....8, 9.

This funny way (mumbling) line means the back of the building, ok, like that, ok. That line really shouldn't be there.....show continuity. Where I was first was.....well, let me draw....here is like entrance door, like big....not even an entrance. That's wrong! Let me redo that because it gives the wrong impression. It gives the impression of doors. There aren't doors, it's just big carved out...and this is...ok. Ok. Uh..here is the overpass, right there, going in like that. Here is the feeling of at least one bay. Also, the feeling that there's some sort of a cubicle there, blocking view when I was standing in the doorway. Here is exit gate. Here is bay window and here is long tunnel going out. All right. Four to five. That's what I said. Ok. Tracked vehicle bay. I will draw a dotted line along here...open area. I don't know where that is that's why....you know..... That's it. Track vehicle bay, and here's..uh..what do you call that. It's not a gate...gate implies something blockage. It's just a passage.....passageway....ok. So that was my track and I stopped right about there. I was getting the feeling of the open on the right and the long hallway on the straight ahead. So that's nine.

#66 Ok. Anything else?

#31 I will write on this. Either very skinny building or it is built into hillside. That rough line keeps coming back to me. All right. Looking away from the place I had the feeling of this down slope. Let me draw you.....best way to do is perspective, I think. Not a perspective, I mean a side view.

Ten. The building...the building level is about like and then gentles on off like this...down and then it starts to take up again, ok. This is the hillside to the rear. Here's the building. The gentle slope..open slope...slight valley...vegetation begins...ok...and then vegetated hillside. That's about it. Want me to darken any of this up or do you think it will zerox ok?

15
~~SECRET~~

~~SECRET~~

- #66 That's ok. Anything else you want to add?
- #31 No. Wait a minute. Yes, there is.
- #66 Ok.
- #31 How do you draw a profile of a tank? Tanks. Tanks are all alike. There's muzzle break. The squashed cupola. The squashed round cupola. or not cupola..turret. The..uh..fenders....bigger than that. More like that. It had a split engine compartment in the back...had it sticking out like this...and over here was thing...rear fender again. This is an artists conception of a piece of shit. And the other down slope here, is where the other star was. I'll put one here. That's all I can do for drawing a tank, I'll tell you. The front end of it...this is the slope and there is something on each side of it. Of course, that's in perspective. That's laying back. Those are front fenders. That's what I'm trying to get. There. That shows it laying down like that. I got the feeling of two lights, lamps or something or racks, circular racks sticking off the front end of the thing. That's not looking too bad now, is it. (Mumbling) I've discovered how artists do so well. They scribble so that nobody can tell them it doesn't look very good. You know they put so many lines down there, one of them has got to be right. Well anyway.
- #66 Why don't you label them front, side, and back views?
- #31 Now, Ok. That's all I can do #66.

~~SECRET~~

TAB

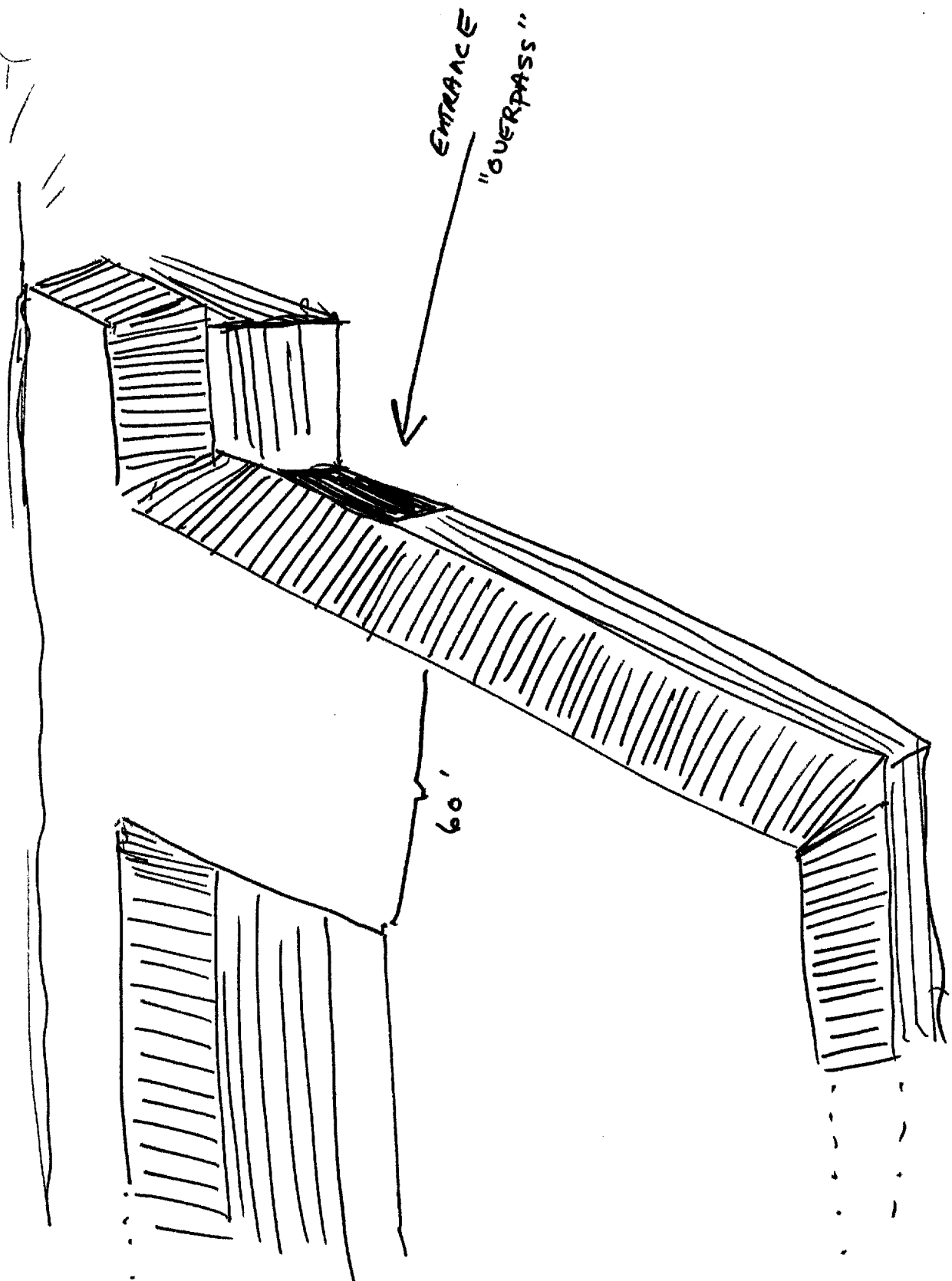

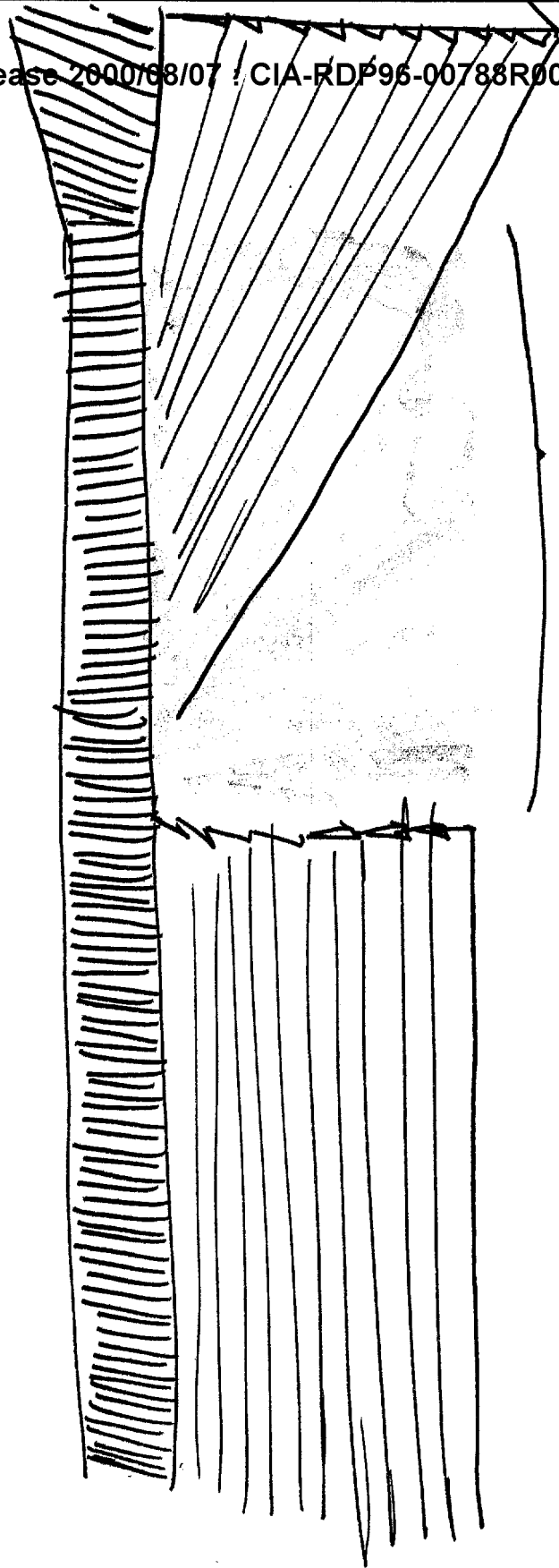

35' - 40'

LOOKING BETWEEN 2 BLDGS
UNDER "OVERPASS"

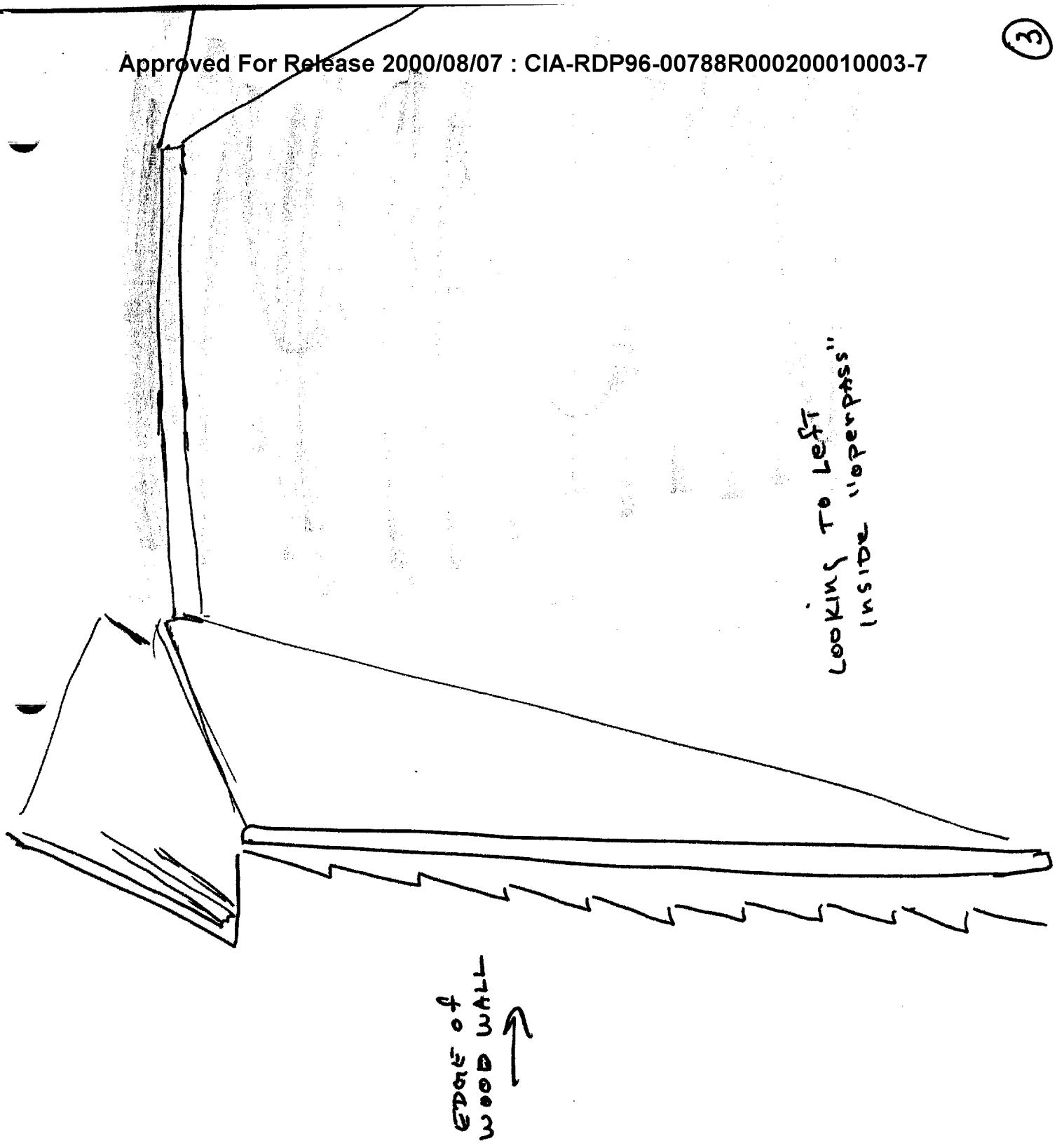

LOOKING TO LEFT
INSIDE "OPERPASS"

EDGE OF
WOOD WALL →

"overpass" seen from other end.
~~diagram~~

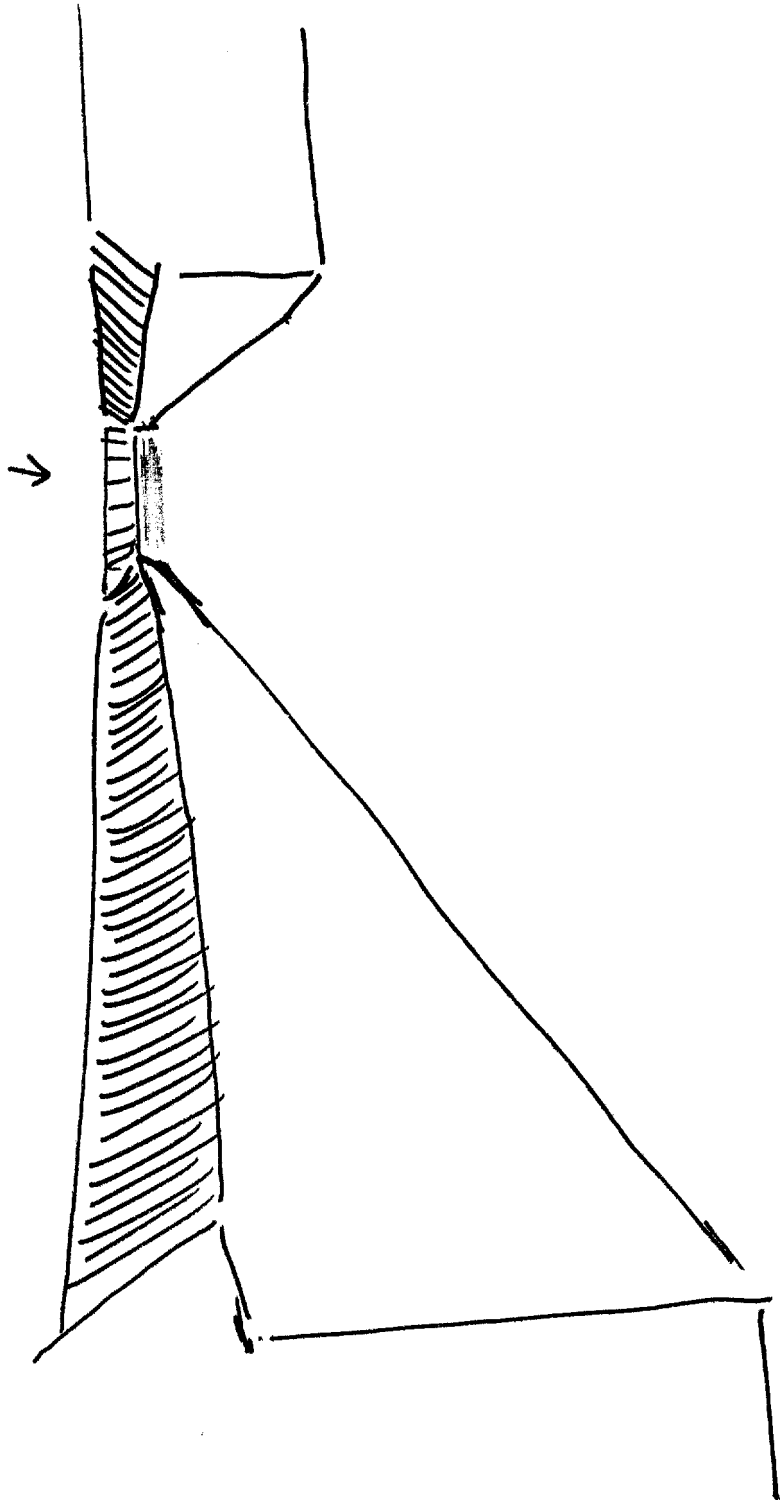

②

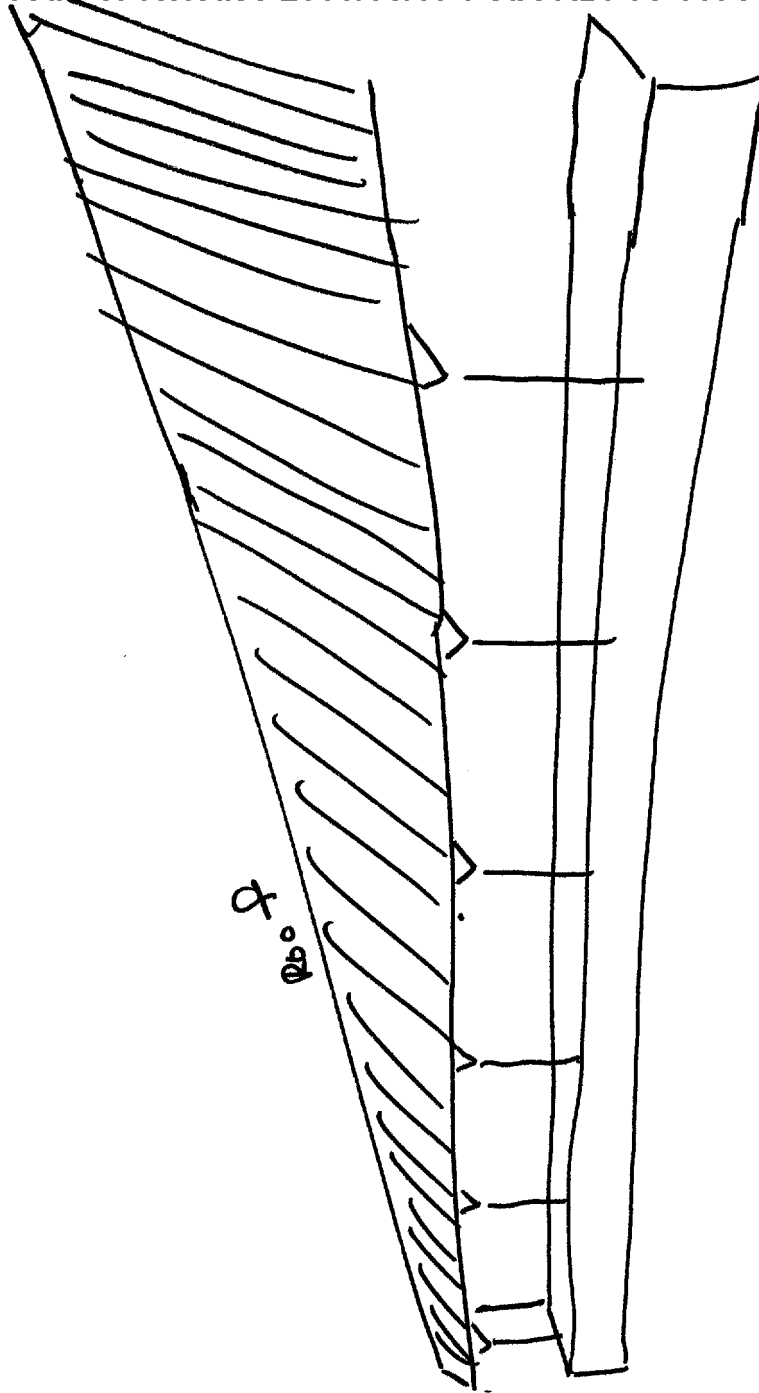

φ₀

LOCK IN'S
DOCK IN'S
INDENTURE
OF 3/16"

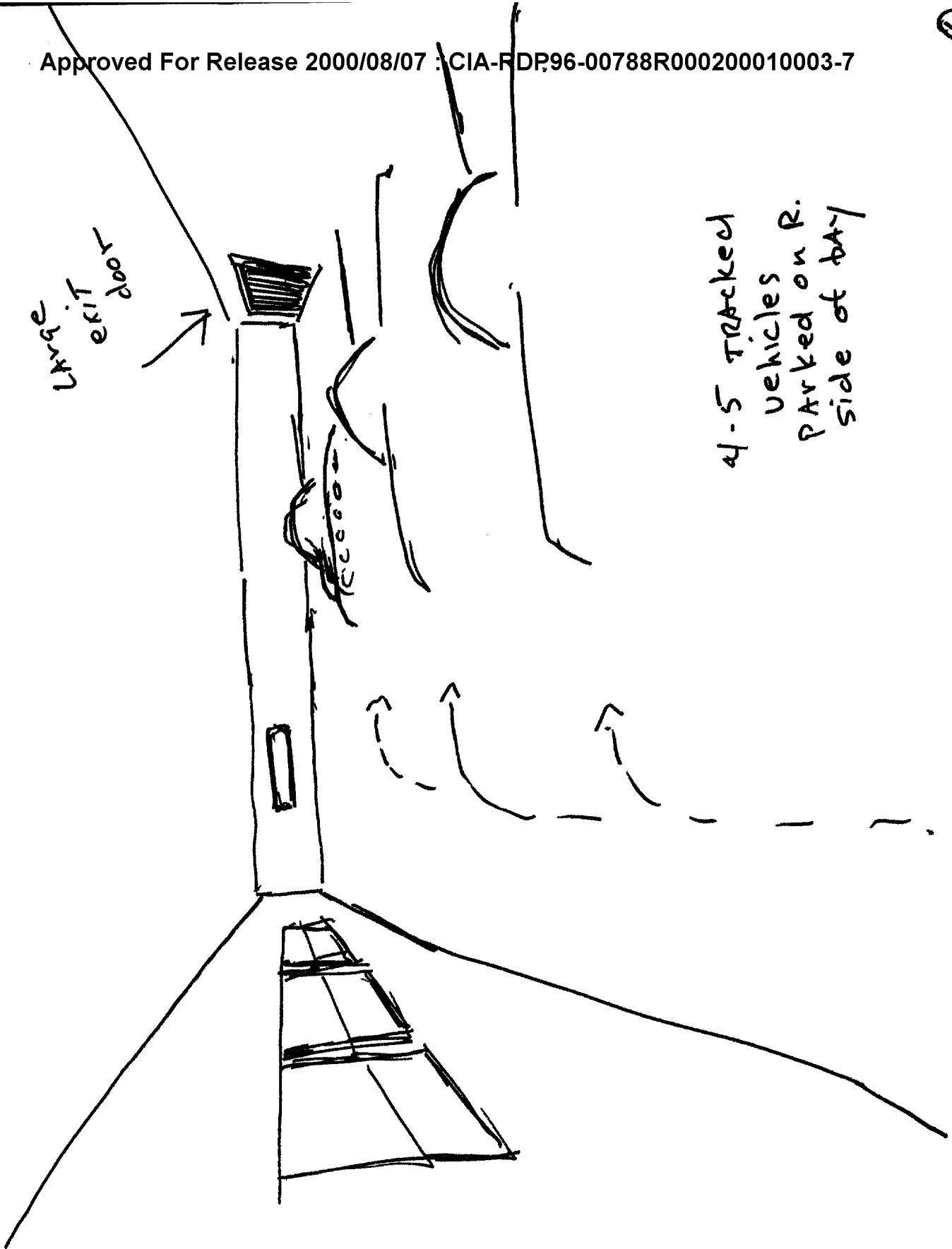

4-5 Tracked
vehicles
Parked on R.
side of bay

⑦

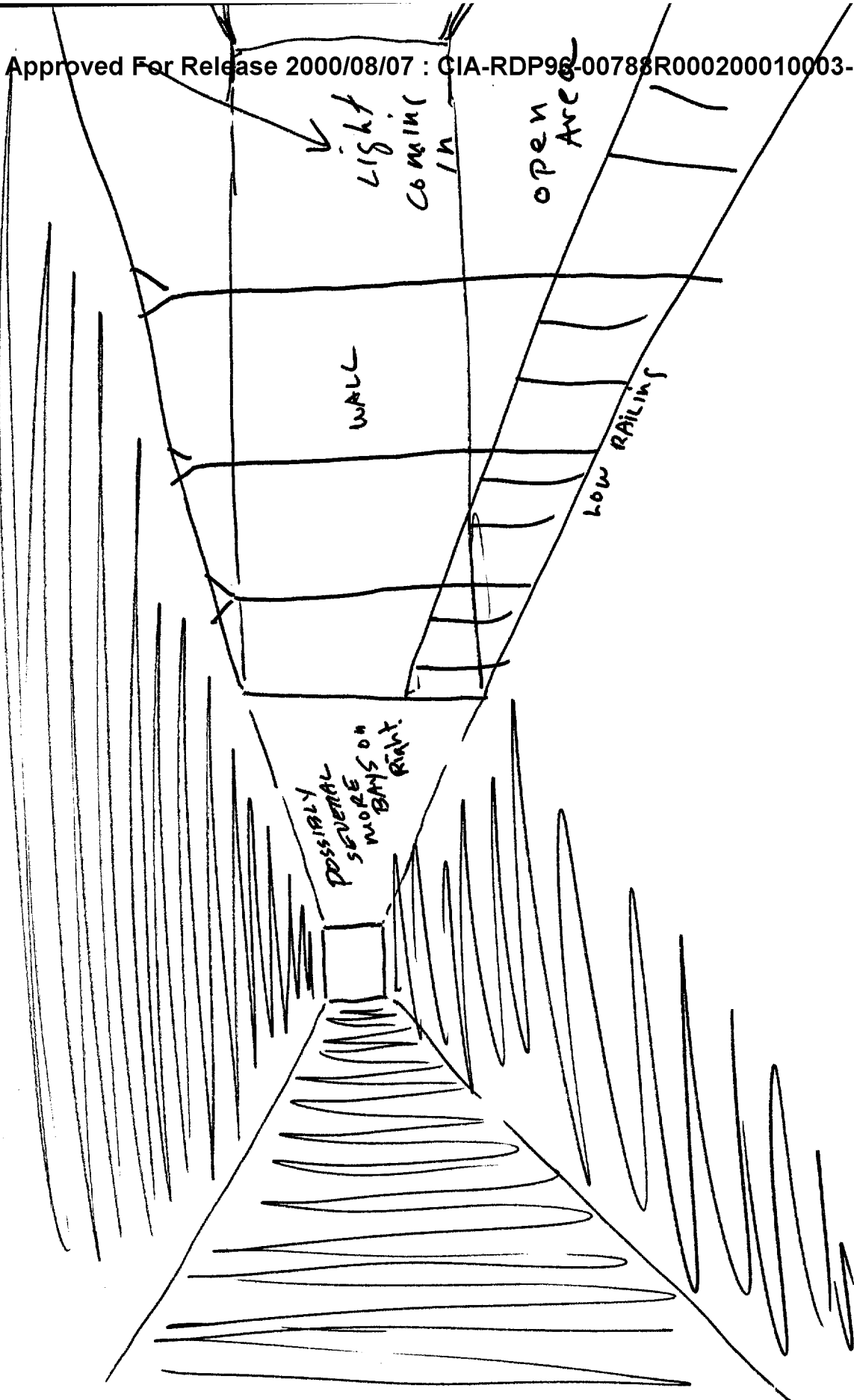

hilto P

gentle
down
slope

ridge

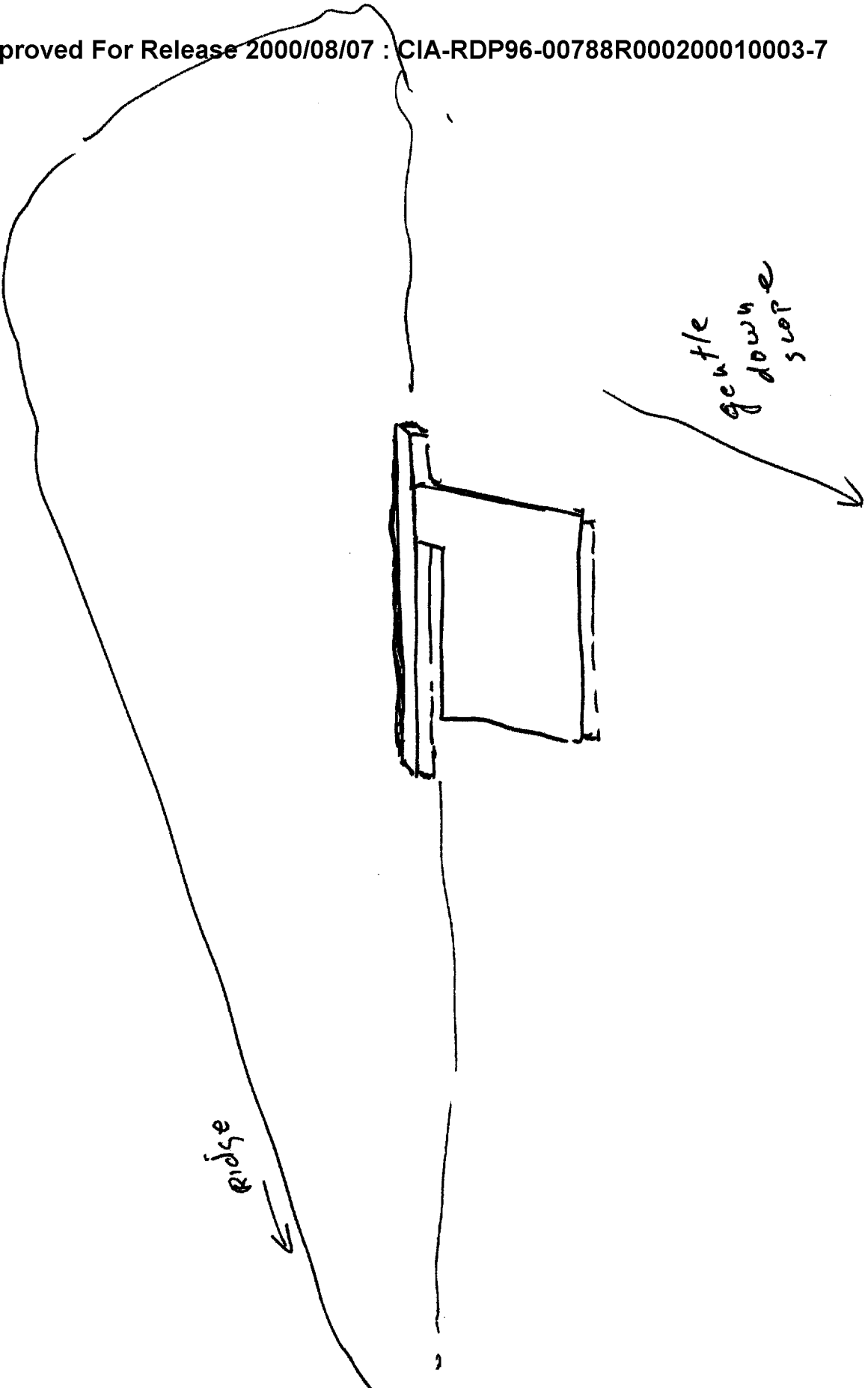

9

EITHER very skinny bldg or
it is built INTO hillside

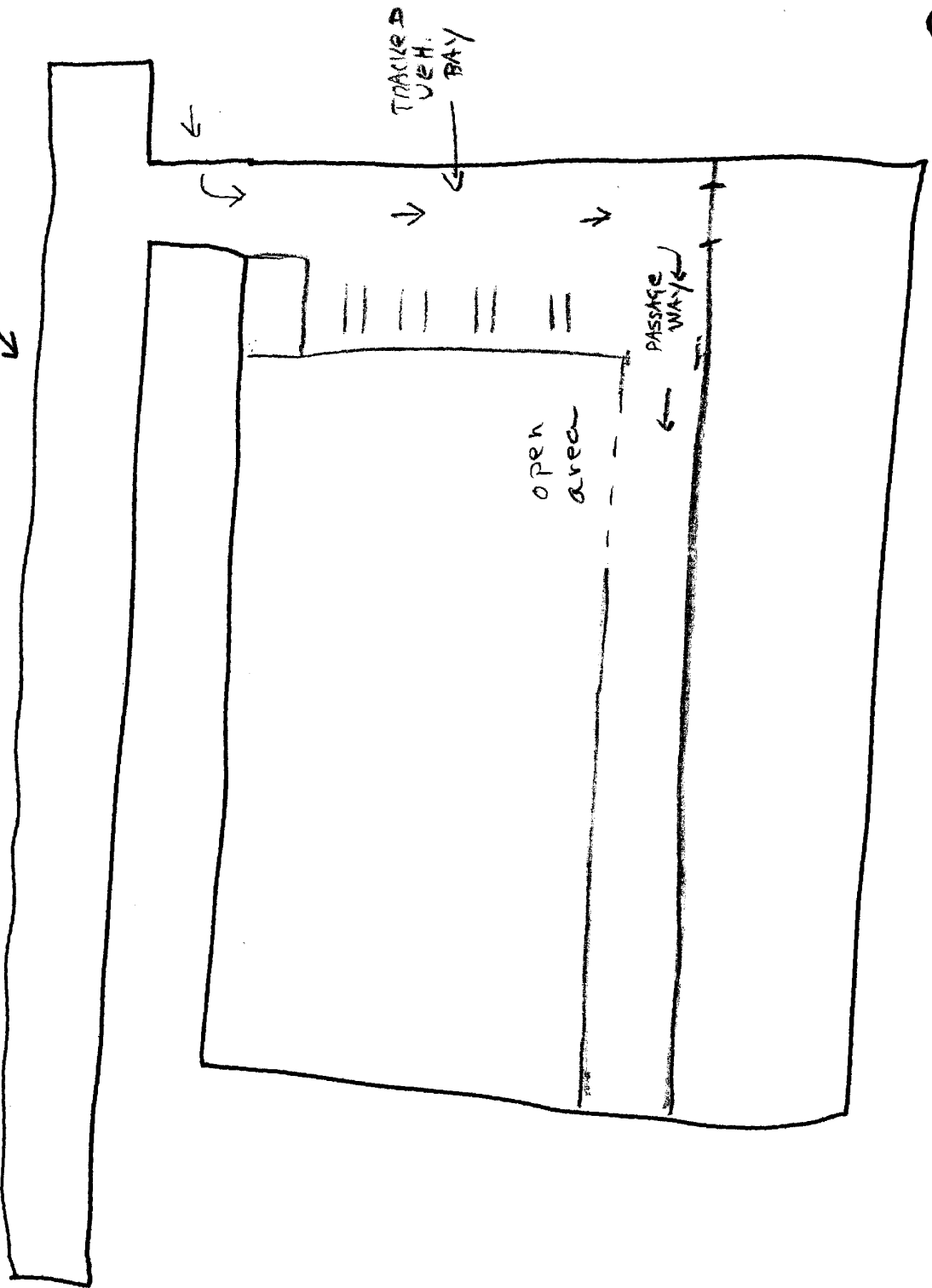

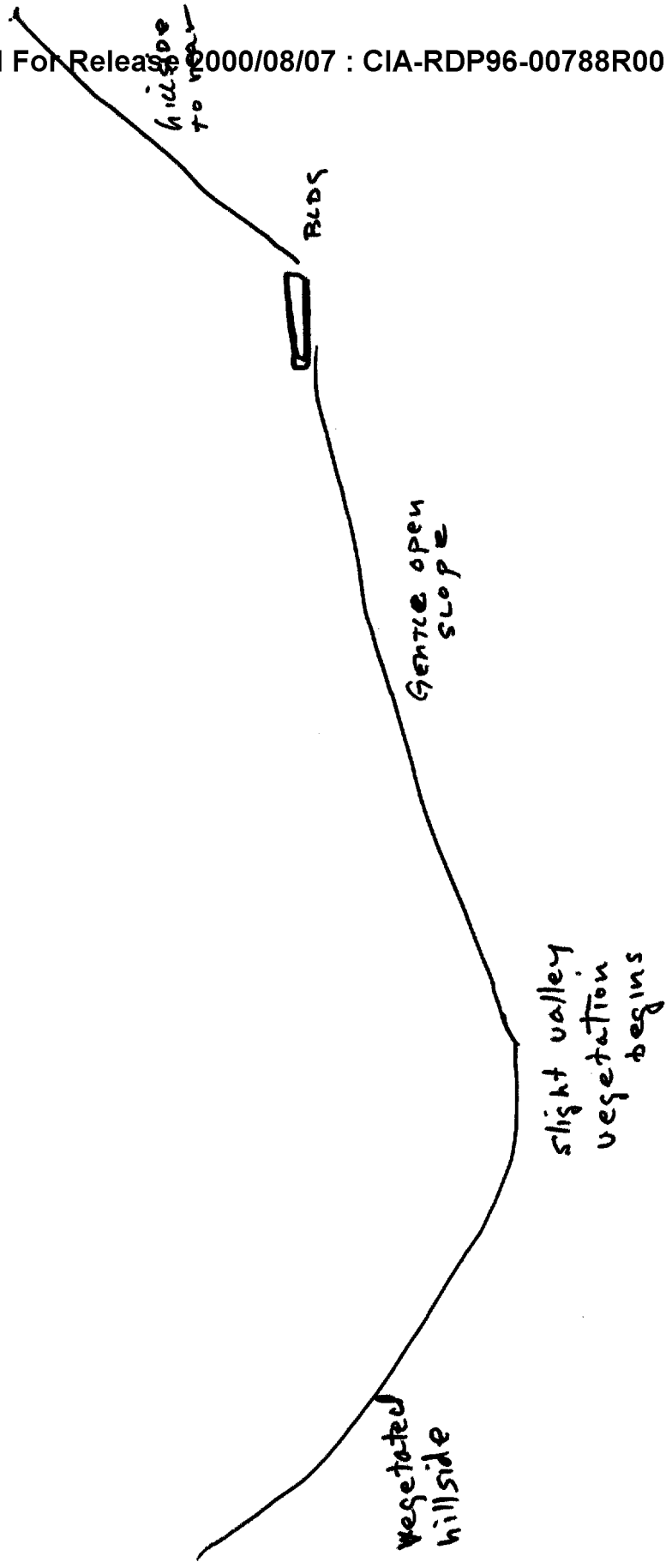

front

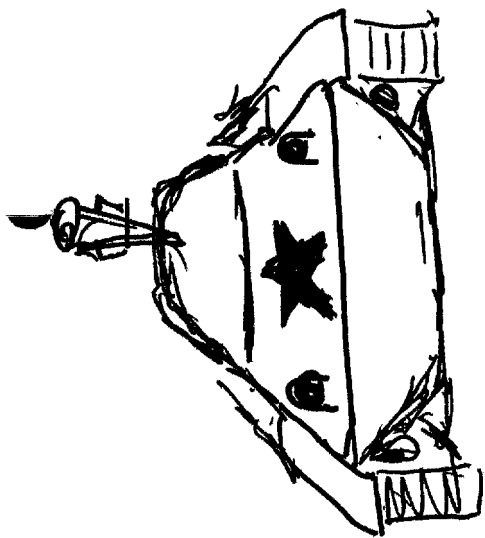

side

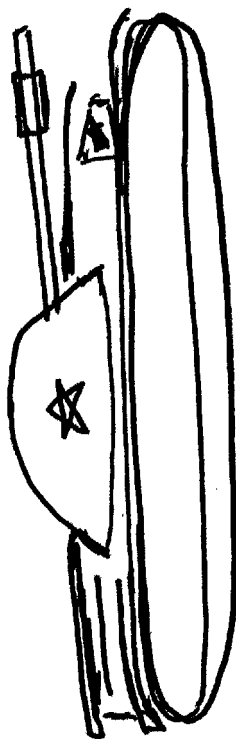

rear

