

~~SECRET~~

TRANSCRIPT

REMOTE VIEWING (RV) SESSION CC 96

TIME

#66 This will be a remote viewing session (edited for security).

PAUSE

Concentrate now, concentrate, relax and concentrate. Focus your attention on your target for this time. Relax and concentrate. Relax and concentrate. Focus, focus:

SG1B



Relax and concentrate. Relax and focus.

SG1B



Relax and concentrate and describe the area to me.

PAUSE

+04 #01 Getting the impression of a coastline. Keep seeing round, round, rounded concrete forms. Uh..looked like a square building rounded on the edge on one side and appeared to be dark bullet shaped outlines in that (mumbling) building. (Mumbling) in one building I see..uh..appears to be..uh..appears to be more than six buildings but I'm seeing what appeared to be six rather large buildings. This is aside from the concrete shaped building with the round side. These are..uh..got low hip roofs and they are fairly narrow in comparison to their length. Appears to be 3 or 4 to the left of the road. The road goes down the center. Usually in another group of buildings on the right side. Appear to be 2 or 3 on the right and some smaller building shapes on the right. I'm seeing..uh..what appears to be an open area to the front (phonetic) on the right which is between the road and the long building...and there's vehicles parked there. Uh..... appear to be a row of vehicles. Uh..it's difficult to tell what they are. They look alot like APC type vehicles. There may be 12 of those parked there.

+06

~~SECRET~~

~~SECRET~~

#66 Relax and concentrate on the target now. Spend some time on the target now without reporting to me.

Relax and concentrate and focus on your target.

PAUSE

+12

#01 This is ..uh..appears that..uh..this has got some kind of a..uh..a mechanized infantry outfit located with it. But, I'm getting an impression that they are part of a contingency force there or labor force, or something. They're protecting this..uh.. (mumbling) installation.

#66 What is it that they're protecting?

#01 I'm getting a...like an impression of a earth and design....like a pattern on the ground. It's..... I want to say it's a five pointed star, but it's not. It's a....it's like a tree with (mumbling) lens pattern. It's just a pattern and it's got rounded edges at the top of each of the legs and there's..uh..there's a prong kind of design...almost a..uh..four pattern, four point star design at the end of each leg. I guess these are dirt roads, or something that make these patterns on the ground.

+15

I'm seeing what looks like..uh..that's part of it.... the patterns.....there's a series of about 5 bunkers close to the buildings and what I was describing was the buildings on the left side. It's apparently a whole complex here. There's..uh..what looks like a table shaped building with legs. Like looking at the edge of the table..uh..winged type things coming down. And that has its own..uh..its own similar wire fence around it.

#66 Let's explore this building.

#01 Got strong feeling of electronic in this building. Like a..uh..like some form of communications, or something. I'm also getting impression that there's special group of..uh..special group of..uh..people working there. That..uh..almost like a..uh..I don't know how to describe it....uh...like they are brought in to work at this place.

#66 Tell me what makes you say that. Tell me the raw image.

#01 They're different kind of people. I don't...raw imagery just says that this is a group of people that

~~SECRET~~

~~SECRET~~

are not like the rest of those people on this compound. It's...this building is an add on to this facility and it's rather recent. It's probably..uh.. probably a year old.

#66 All right. Spend some time in this building without reporting to me. Relax and concentrate and focus on the building.

PAUSE

+21 #01 Getting..uh..getting one very clear impression of..uh.. some objects in this building and I'm seeing a..uh.. appears to be a very large curved glass screen. I'm seeing a number of these. They're very, very dark. Almost iridescent green and they are cross-hatched with squares that are approximately 5 by 5 centimeters and there's a..uh..like a..uh..almost a..uh..a graphics display type of picture that's going and coming on these. And, there's ..uh..they are sort of grouped in a rather large room in a semi-circle. There is a large light gray metallic cabinet associated with these. And, an even larger one that appears to be fairly narrow but taller standing to one side. I'm...for some reason getting a strong feeling of, of, it doesn't seem right but I'm getting a very cold feeling in this room. A much colder feeling in this room than the ambient outside temperature for some reason. The..uh..keep looking for some kind of electronic specifics and I can't..uh..keep getting the word waveguide....keeps popping in my mind. But, I don't know if that's clutter. I don't know what it is. I don't see anything that appears to be any kind of a waveguide. I'm not sure that I even know what that is. There's..uh..

+24

PAUSE

I'm looking for some kind of a front end collector for this and I...I'm seeing a..uh..a covered..uh..trench or tunnel that's not very large but it's probably 3 feet wide 1½ feet wide running out to one side in this building going to what appears to be that rounded type of structure. That concrete building that's kind of rounded on one side. I'm not getting any other kind of impression.

#66 What's going on in the building right now?

#01 There's alot of..uh..just alot of activity with..uh.. uh..people looking at dials and things.

#66 Tell me about the people.

~~SECRET~~

~~SECRET~~

#01 Very Slovik type of people...higher cheekbones...I'm I'm getting double images here...when I'm looking at the people I'm getting images of troops and..uh..in kaki jungle type uniforms. They're very, very dark complexion with heavy features but not Slovik features. I don't know how.....the other people are fairer skinned I guess. That's a major difference. They also.....uh... they got higher cheekbones in general. Their faces are rounder. I think that's a primary difference.

#66 Who is in what role?

#01 I'm not sure. I'm not sure which are in the building. When I'm thinking of the people I'm..uh..I'm getting flickering images at both times but I'm getting different backgrounds. I'm not I'm all in the same building when it happens. I only see the Slovik feature people wearing coats of some sort. Like shortened..uh..lab coats, I guess. Sort of an off-white lab type coat. Think the guards are the darker skinned. Scary force of some sort.

#66 All right. At this time I have no further questions about the target. If there is anything you would like to add about the perceptions that you have had, please do so now.

PAUSE

#01 I think I spent a large majority of time in one corner of this complex. I think there's probably at least 20 more buildings that I haven't really given credit to.

#66 Before you leave the target area be sure that you have aerial perspectives so that you may draw a rendition for me.

#01 That's maybe going to be a little disjointed, but..uh.. I think I have the corner down at this..uh..these other buildings (mumbling)..uh..I just had a flash of..uh.. appears to be some kind of...blated reflector...4 sided reflector or something.....uh.....I don't know what it is. For some reason I got a strong image of this thing.

PAUSE

I don't have anything else that's coming through here.

#66 All right. Let's draw then.

~~SECRET~~

~~SECRET~~

#01 Page 1. I got impression of these buildings. They had sort of like a...the low roof....slanted low roof. Impression of 3 on the left. I think there were more but I just saw 3 of the very large ones. There was like a road that came in this way. And, I saw 3 on the right. Then I got an impression, I was really straining to see whether there were more, more buildings than that, because I sensed that there were. As I was doing that, I got an impression of some kind of row of vehicles like, parked this way next to this building. Looked like APCs or something. You know like this. There were a bunch of those. I can't remember how many. And, there were a couple parked way back here. (Mumbling)

#05 Same kind of vehicles that.....

#01 Same kind of vehicles. For some reason, I got the distinct impression that what I was looking at from overhead was some kind of, of mechanized infantry unit, ok. And, that I was only looking at a very small fragment of this complex layout. So..uh..there was other buildings.....possibly barracks buildings over here. How many, I don't know. I just had a feeling for a whole lot more buildings over here. A whole lot buildings. Up in this corner where this fancy arrow is, is the area with..uh..what do you call it..special building, ok. I don't feel like it was ever part of this complex originally.

#05 You said you thought these were APC?

#01 Yeah. APC like vehicles. I'll give you a little sketch of what they looked like. When I was reviewing on the end of the session I kind'o zoomed in on a couple of these and saw a distinctive pot covering like with lines in a certain pattern on top.

#05 Did you determine the function of these long buildings?

#01 No. I didn't. I was trying to and I was just struck with the impression that I'm looking at a mechanized infantry unit, brigade, or something. I don't know why. It may be as a whole, that this thing, you know, it may be that for some cosmic reason, as a whole, I saw everything in the buildings at one time, or something. I don't know what gave me that impression.

#01 Second impression that I had was...oh...down here, I'll put another arrow on page 1, there was..uh.. what I'll call an outline pattern, down in this area, and this is what it looked like. I'll put a matching arrow on page 2 to show you...ok...now these two pages were put together the arrows would match, ok.

~~SECRET~~

~~SECRET~~

#05 Did you have a feeling for compass direction?

#01 Yeah. I'll put you a compass direction on here. This being true north, ok...uh..this outline pattern was almost imperceptible from the air. I got the feeling it might be dirt road. It looked something like this. Like a big bird's foot...five pointed bird's foot. I got the impression that there was something half-moon or round shaped at the end that was a solid and that there was a..uh..superimposed over this was 4 pointed star formation. I don't have any idea, detail wise, what this is. It struck me as being a significant pattern for some reason. It may be their sewage treatment facility. It may be an antenna field. But, I was struck by the uniqueness of this pattern. This was probably dirt roads.

Now the special building...3...was like...uh..again drawing that same corresponding fancy arrow so that you know in perspective, page 1, where I'm coming from here. There appeared to be like a..uh..section of fence up here, like this, and this was the outer perimeter fence to this compound. I think. I can't say that for sure. I'm just probably hypothesizing here, but there was an outer fence like that, and then there was this..uh..what looked like a table, like a ray on legs.. This was the special building, ok, and there was like ..uh..I got an idea like a concrete trench where these dotted lines, it came out. I'll tell you. I tried to see inside of this trench and I'll show you what I saw in there. I don't know what it is because all it is is a bunch of lines coming (mumbling)

This had an individual fence around it all its own. Just a single, you know, a single fence. Like it was some kind of a higher security area, maybe. And, that's really about it.

For the special building, except for the contents, which I'll get to in a minute,...

#05 Would you mind putting north arrows on it. I can keep up with it but later on.....

#01 Ok. Contents of this special building, what I saw, ok, I'm going to do this on a number of pages, was, I got the impression I was looking sideways, large circular glass type thing and it had lines going like this on it. You know, how you get the impressions that you could see only part of the lines because you are looking from the side.....and I had lines running this way.....

~~SECRET~~

~~SECRET~~

#01 There's like 4 or 5 of these in this room and these were on large gray pannels and underneath this were like geometric designs, ok...like a graphics type thing. This was dark green. Almost like a huge radar scope only much larger, ok. Distance being, like 2 by 2 feet, you know, just really huge things, and.. uh..these were dark green and the lines were white..... and the graphics were like a gold color.

Page 5. These were like...if you can image these boxes with circles in them representing these, these were like in a half-circle like in this one room and there was a large long metallic cabinet over here. And, I got a feeling like this corner, this might have been an exterior wall because this is where I got my ...first got my impression of that tunnel like thing going where these dotted lines are, ok. So that would put it page 3 roughly where this star on this special building is located. I got..uh..out at the end of this tunnel is where I saw this..uh..this funny looking structure, and, all I can tell you, it's not real large, but, it's concrete and it's square and I got the impression of a large round piece here that was also concrete.

This is page 6. From the side (mumbling) from the side, this being ground level,...from the ground level I got the impression it was like the building was square like this, and then, this went like that as well as round this way, for some reason. Call that side view with the trench, or whatever going in there. Trench being about 3 by 4½ feet. I had an impression of one other item, right at the end. For some reason I kept trying to look for some collector or some unique front end to all this garbage that's in this building. The last impression I had was really strange because it doesn't look like anything I'd ever seen before in my life...appeared to be like..uh..it's going to take a minute to get this drawn out here....I don't know...a cutaway, ok, would look like this. Do you understand that drawing #05? If you would cut it there that's the view that you would have.

#05 I don't understand it?

#01 This is the bottom which was set on a round. That is the light thing. For some reason I was struck with this being some kind of rotatable type reflector of some sort.

#05 Oh! Ok. I see...you...the thing is open in the center. It's like you've got a horizontal cross-shape at the top and one on the bottom with air foil shapes and sizes.

~~SECRET~~

~~SECRET~~

- #01 Right. Air foil shapes on the side and it's rotatable. This thing is fairly large. Like..uh..like 6 feet, you know. I've never seen anything like this. I don't know what it is. It is just a distinct clear impression I had.
- #05 I know what you described there. I don't know where the (mumbling) of those but I know what it is.
- #01 Ok. That's it. An abundance of detail but very clear.
- #05 Uh...you mentioned something called a waveguide in here; then you mumbled something...you didn't know what that was.
- #01 I don't have any idea what that was. Just the impression I had.
- #05 What do you think it was like that you don't know what a waveguide thing is or you don't know what the thing was.
- #01 I would imagine a waveguide to be some form of cabling. But, that's not what it is. That's not what's telling me "waveguide." Ok. I keep seeing like a box for some reason and I keep wanting to call it "waveguide" and that doesn't make any sense to me at all. But that is something that is clearly impressed upon me. It's not, you know, it's not what I would identify as waveguide and that's why I think it is important. It's a box...what appeared to be empty box and the word "waveguide." I don't.....
- #05 What I misunderstood there was I didn't know whether you were saying you didn't know what a waveguide was or you didn't know what this thing was.....
- #01 I really, I really don't know what a waveguide is, but I would imagine it to be some form of cabling, ok. But, distinctly what I'm seeing in my mind's eyes is not cabling. It's some kind of a box and the word waveguide associated to it.
- #05 I did some interesting correlation. I have no further questions.
- #01 There's..uh..one other thing. I was going to do a view of one of the tops of one of those vehicles. The reason why they impressed me APC like is I got a distinct wedge shape front like this going back with..uh..somall wind streams (phonetic) in the front with man areas here.

8
~~SECRET~~

~~SECRET~~

- #01 This being flat metal and like..uh..a small raised portion here went back like that. And, there was ..uh..lines of...grooves or something in the metal going back up like this. Uh...that was like a covering of some sort. I came down like that. Now don't mistakenly be left with the mistaken impression that I saw tracks, because I didn't see tracks. I didn't see anything on the side, but that's essentially what I was seeing. Like an armored car, almost. APC armored vehicle of some sort, ok. APC is what I call it because I was impressed..... with.
- #05 You didn't comment on the black rectangles you have there.
- #01 Oh! These are vents. Some kind of vent but it had a distinct wedge shape to it. Distinct grooving or ribbing across the top, the metal and two manned compartments in the front. Like a guy could open 'em up and pop his head up through the holes. Ok. That's it.

~~SECRET~~

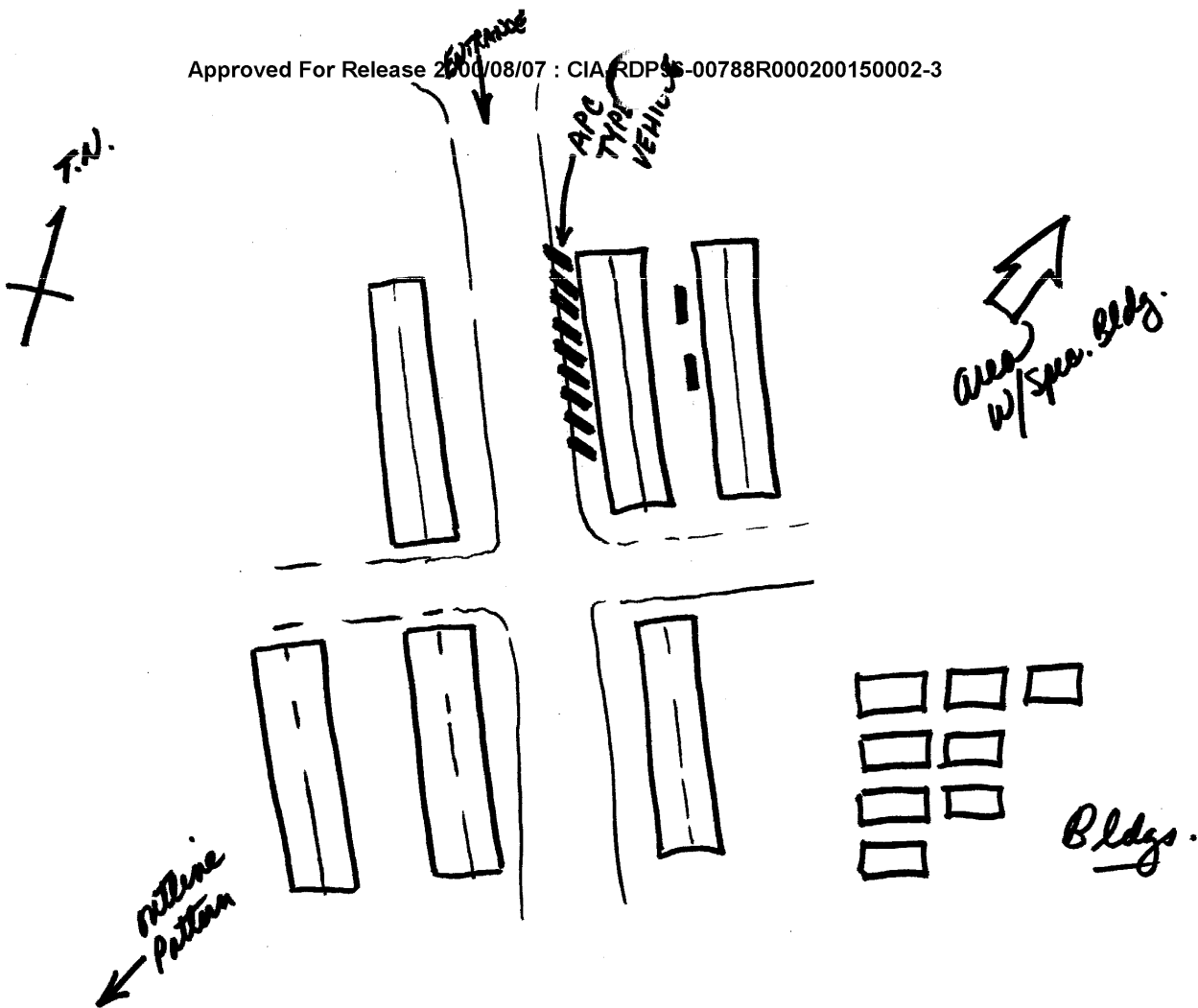

T.N.
↗

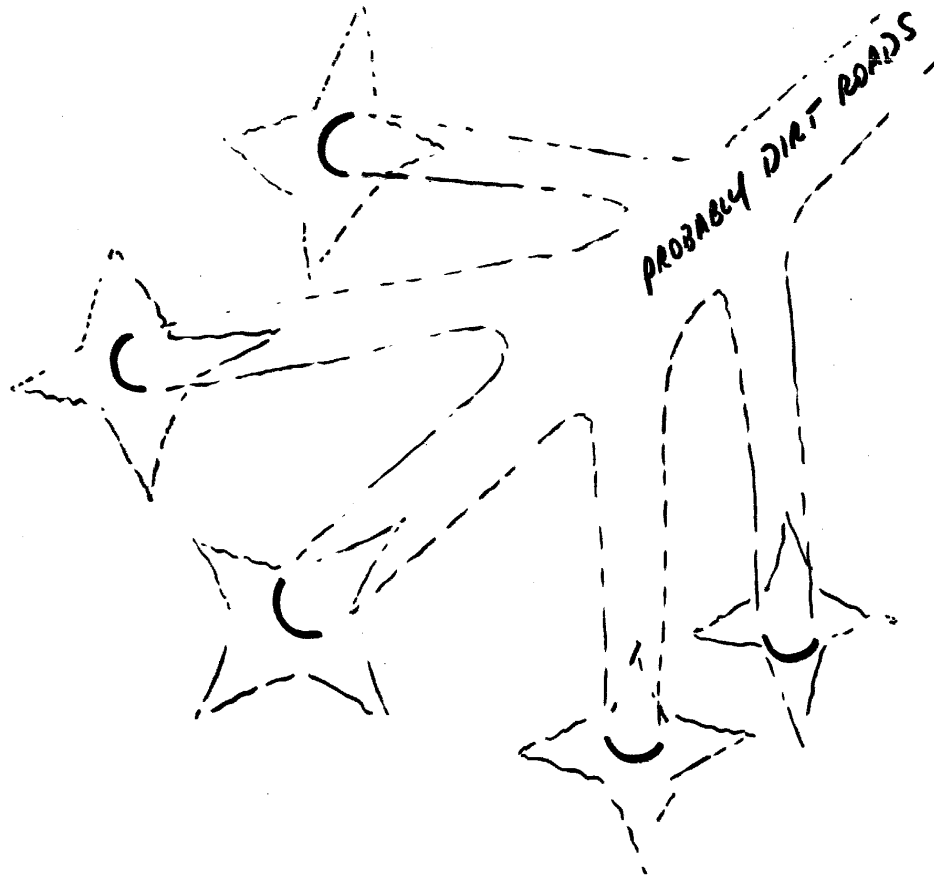

T.N.
↑

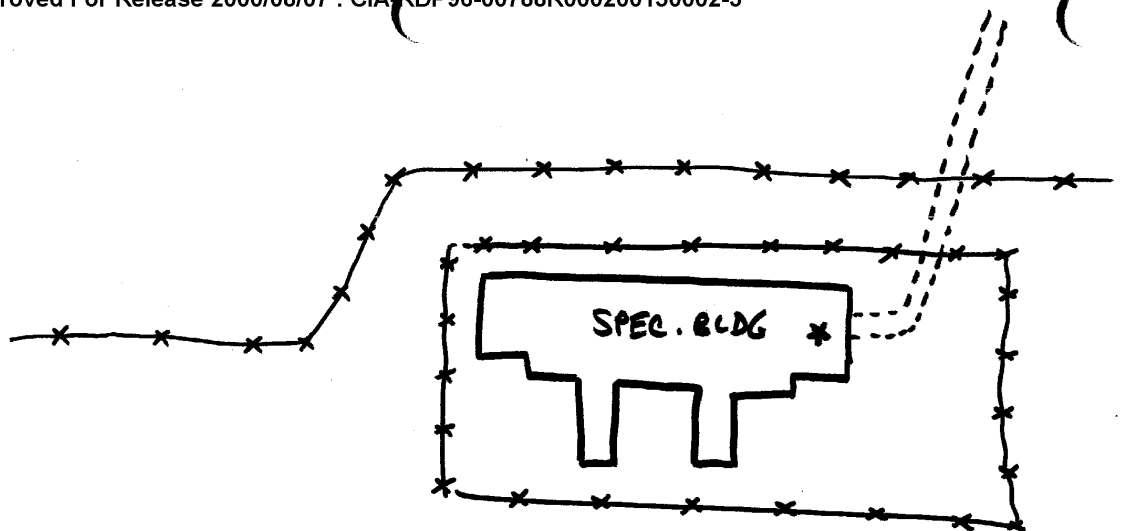

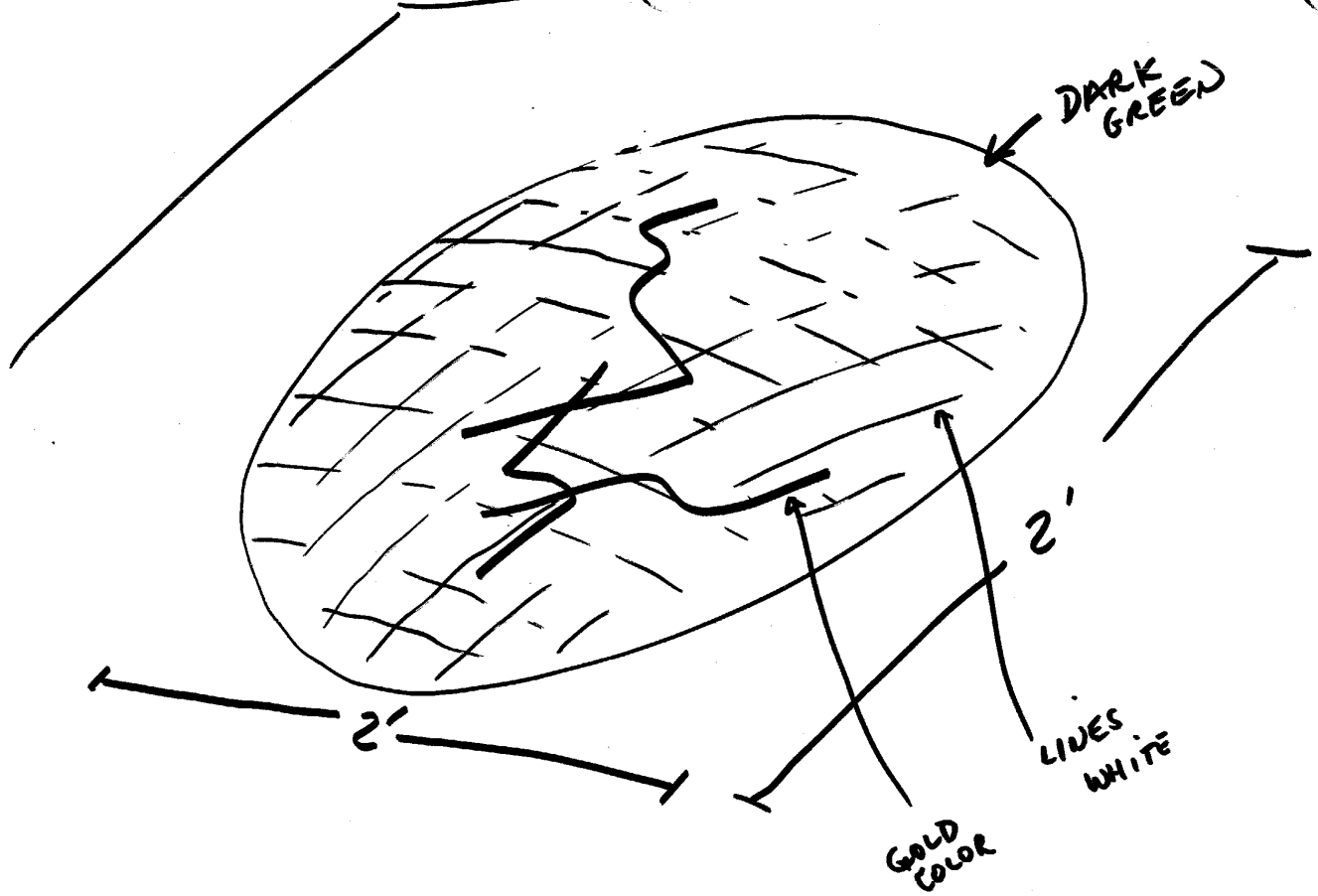

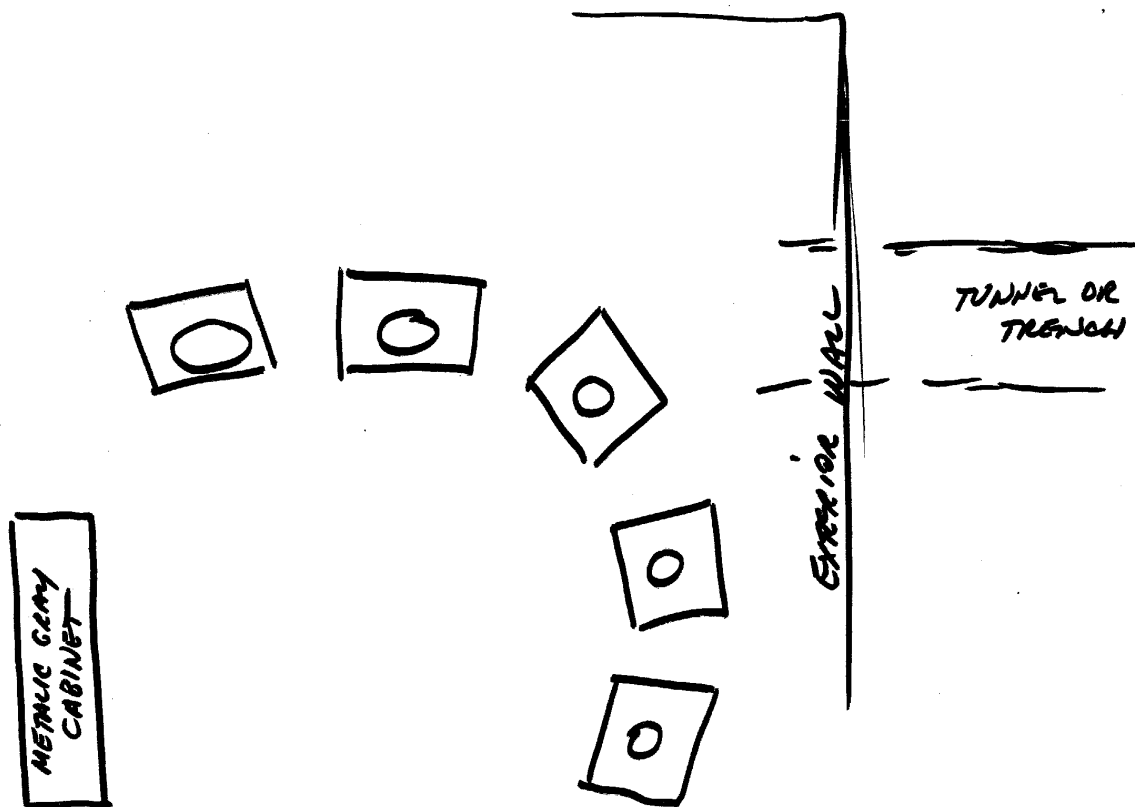

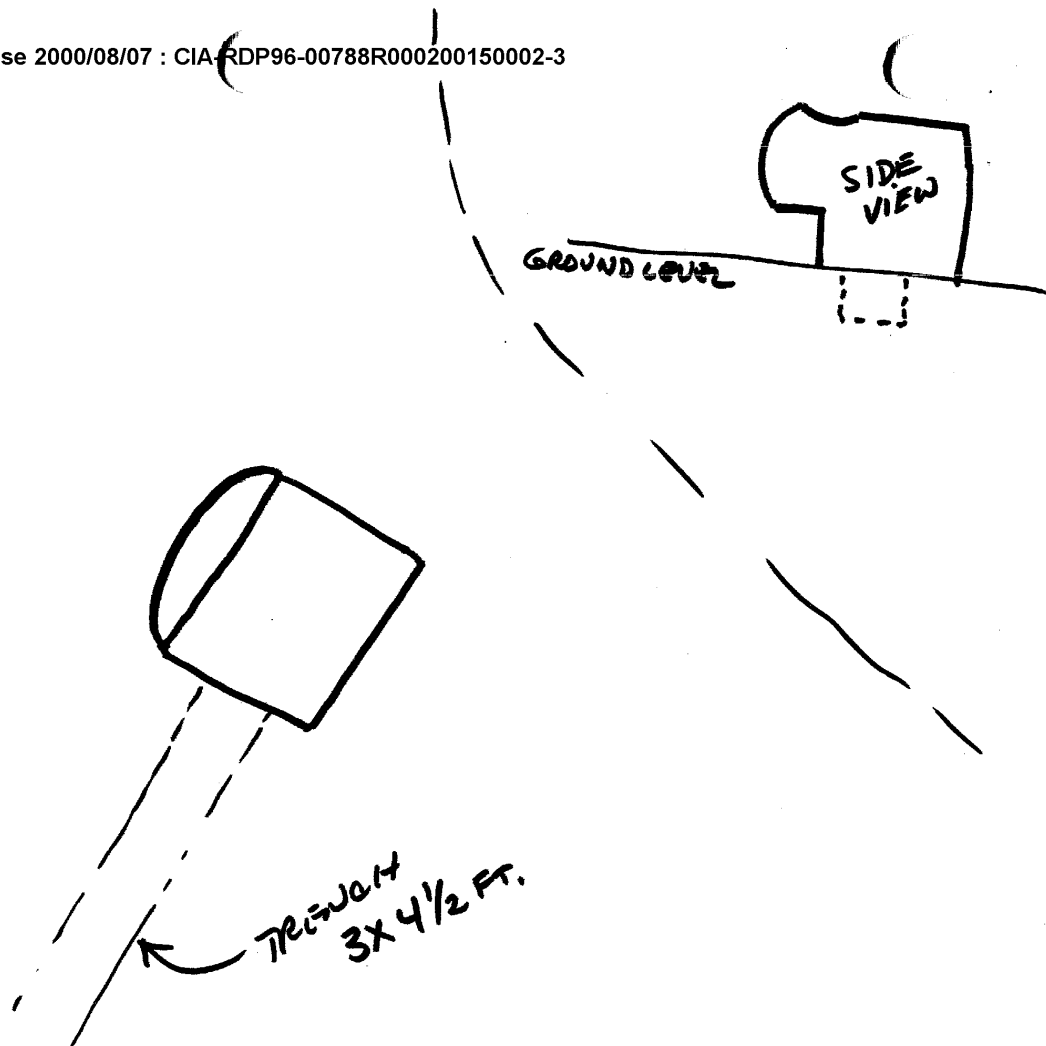

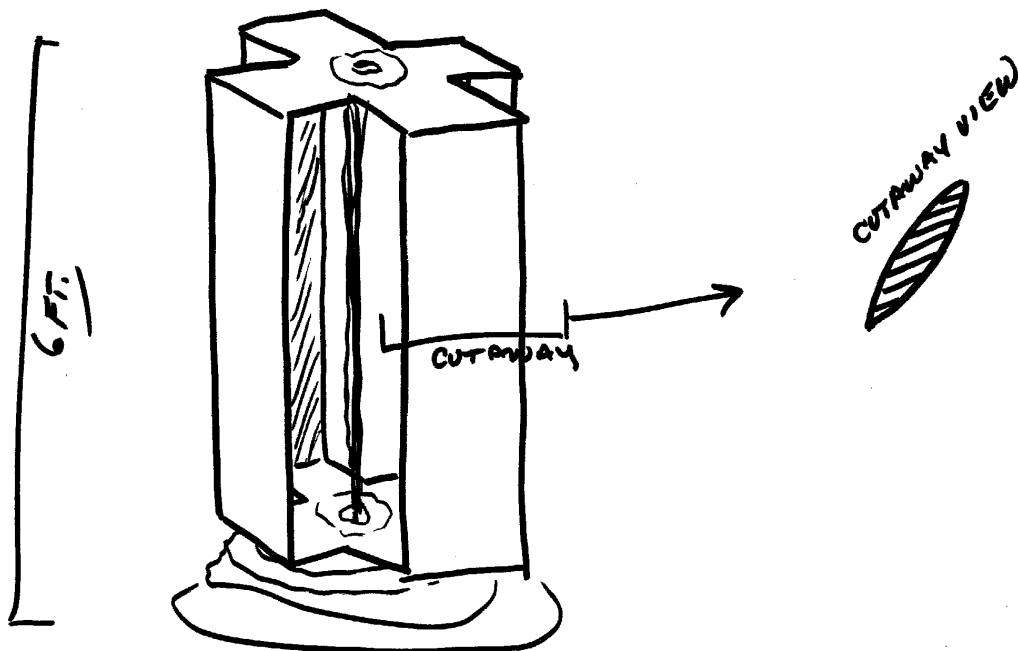

Approved For Release 2000/08/07 : CIA-RDP96-00788R000200150002-3

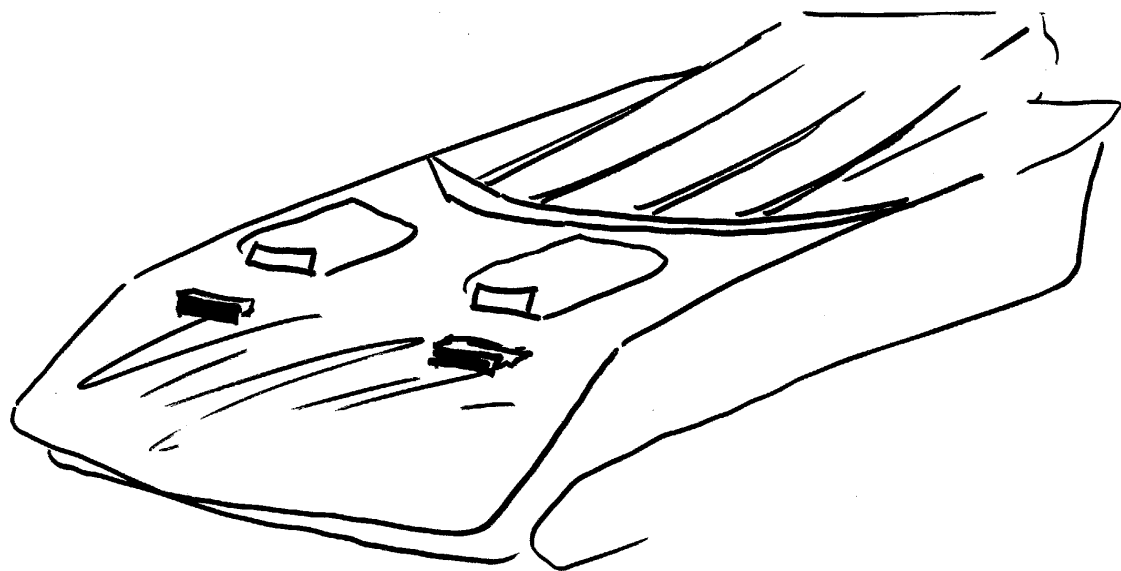

Approved For Release 2000/08/07 : CIA-RDP96-00788R000200150002-3