

~~SECRET~~

INSCOM

GRILL FLAME

PROGRAM

SESSION REPORT

CLASSIFIED BY:MSG,DAMI-ISH

DATED: 051630ZJUL78

NOT RELEASABLE TO FOREIGN NATIONALS REVIEW ON: Dec 2000

~~SECRET~~

GRILL FLAME

67-003-81
copy 106 3 copies

~~SECRET~~

SUMMARY ANALYSIS

REMOTE VIEWING (RV) SESSION DC-49

1. (S/NOFORN) This report documents a remote viewing session conducted in compliance with a request for information on a designated target area.
2. (S/NOFORN) The remote viewer's impressions of the target are provided as raw intelligence data, and as such, have not been subjected to any intermediate analysis, evaluation or collation. Interpretation and use of the information provided is the responsibility of the requestor.
3. (S/NOFORN) The protocol used for this session is detailed in the document Grill Flame Protocol, AMSAA Applied Remote Viewing Protocol (S), undated.
4. (S/NOFORN) Following is a transcript of the viewer's impressions during the remote viewing session. At TAB A are drawings made by the remote viewer reference his impressions of the target site. At TAB B is target cuing information provided the remote viewer. At TAB C are control analyst questions and comments during the session.

~~SECRET~~
NOT RELEASABLE TO FOREIGN NATIONALS

~~SECRET~~

TRANSCRIPT

REMOTE VIEWING (RV) SESSION DC-49

TIME

#66: This will be a remote session for 1100 hours, 18 December 1980.

PAUSE

Relax and concentrate now. Relax and concentrate, relax..... relax, relax. Focus your attention on the stadium area in the photograph I have shown you. Focus your attention solely and completely in perfect detail on the stadium area in the photograph I have shown you.

PAUSE

Holding your focus, holding your focus, relax and concentrate. Move now through space and time so that you may perceive the stadium area 2200 hours, 2200 hours, 10 December 1980. Move now and report on the stadium area, 10 December, 10 o'clock at night.

PAUSE

#31: Umm.....I'm in an infield.....

#66: All right. As you stand now in the infield look all around you as you stand in the infield. Look all around the stadiumask yourself now.....10 December, 10 o'clock at night, 10 December 10 o'clock at night in the stadium, ask yourself for information about the stadium area of interest to intelligence. Describe your impressions to me.

#31: Have a, ah, there's some sort of something goin' on here. I've got....when I was out in the infield I was picking up..... a sort of a, had the feeling the lights were on, and that they were on.....not everywhere, but on one side of the...there were people but it was like some sort of a meeting or rally but not, not the whole place occupied.

+05

PAUSE

#66: Narrow your focus a bit. Narrow your focus a bit and discover to which area of the stadium are you attracted when you ask yourself the question concerning intelligence interest.

PAUSE

#31: Umm...I working at a...the area of attraction is the....it's ah, I'm standing right along side a retaining wall that, ah, edge the infield, and...on the, on the.....I have to go up to find out. It's on the east side of the stadium. Ummm.... I'm going to go back downIt seems like I'm closer to the a little bit more than... I'm closer to the north end, than it seems to be to the other end.

~~SECRET~~

~~SECRET~~

PAUSE

#31: I keep tryin' observe that which is of intelligence interest, and, I'm continually always attracted to this area up in the bleachers.....

PAUSE

I keep seeing the bleachers, and I keep getting the feeling that this smaller group of people is a thing of interest.

#66: All right.

#31: But.....now, when I just got here I don't believe there are people, because I just...I went to a seat in that area, and looked down the seat, and there....seats are empty. I don't know what I'm doing here, but, ah.....

+10 #66: All right, I can help you.

#31: Maybe just the people part might just be overlay.

#66: All right. I can help you resolve this situation.

PAUSE

Allow yourself now, to be attracted to this area which appears to be an importance. Move now over to this area, now, when I count to three, you'll be able to look down and see through the seats and see underneath the seats in the area below the seats. Watch now, as I count three, and you'll be able to see through them to the area below the seats.

One, watch carefully, two, three.

PAUSE

#31: Ahmm... It seems as though I'm in some sort of a hallway..... inside.....got like bare cement walls and things, ah.... corner elbow and a staircase.

#66: That's fine. Proceed now to the area of intelligence interest. Move down this hallway. Search out.....

PAUSE

+15 #31: I'm in a room that has a.....sort of a large room..... I feel that I'm on one level down from where I was before. But, it's a....it's got a....let me look at it again.regular piles, pyramids of boxes, ah....on pallets, ah.... Like several I've seen several of these. Like four or five in this room.

PAUSE

~~SECRET~~

~~SECRET~~

#66: Describe the contents of the boxes to me.

PAUSE

#31: Keep getting a, ah, ^{grainey}greeney (phonetic) granular, too heavy to be a powder; too big grained to be a powder. It's more like...something about the texture.....kitty litter, but it's not dry. It's...not wet; it's...like...about like a... while I'm working on this stuff, I see a, a thing that looks like an open suitcase....old fashioned, open suitcase, sitting on a table. This is like a.....no, not like the consistency of....fresh, fallen snow, if you pack it a little bit, it'll stay, but, then the minute you drop it, it'll fall apart. That's what this consistency is, and I keep...seeing it as being this bluish stuff, steel blue, bluish color, bluish color.

PAUSE

#66: The description you've provided me.....may appear different to you. If you can control your perspective of it in your mind, allow yourself to move back away from the contents, and see them from the different perspective. Proceed.

+21

PAUSE

#31: Umm....looking at a block. It looked like about, ah,.... small loaf of bread size. Little rounded...on the edges and corners; oversize brick size.

PAUSE

#66: ...you ready to move now to the infield area again?

#31: Aha.

#66: Okay. Remembering now, 10 o'clock at night, 10 o'clock at night in the infield area, I want you to look at the next 4 hours from now, 10 o'clock at night, 10 December, look at the next 4 hours and describe briefly the activity that takes place. Describe for me if there is any activity in the next 4 hours.

PAUSE

#31: Just don't get any feeling of movement in the arena or out and around in the bleachers. I get a feeling of movement over in this funned up area, down in under the bleachers. It's internal in the building. It's not out. It-no exposed. Some kind of activity that goes on over there. Inside. Not outside.

#66: Report this to me.

~~SECRET~~

~~SECRET~~

#31: People, several people comin' and going. Actually, it was like, more a departure, like two people, one or two people departing. Like they had been here all along, and now are leaving the area. Like they had done, to do, prepare something were here when I first got here, and, so, then, the thing that changes is they leave over the next...period of time. They.... ah....

#66: Describe them to me.

+25 #31:like wearing a.....one that I saw wearing a suit, wearing a gray suit of some older style...feeling of like a....olderI'm reminded of like the suits of the 50's. He's carrying that round briefcase. Roundedold fashioned briefcase... he's leaving.....earlier I'd seen this.....briefcase having the squares put in it. It was as though.....I don't know if it's....the squares they were being loaded in it like....they're like bricks, and they were like....I don't know....when, when I thought they were stacks of bills, but at the other point there, I thought they were like blocks of, blocks of this funny stuff that I was talkin gabout, being put in a brief-- suitcase.

#66: Okay.

#31: That was before; but now I think I'm getting is this guy leaving with a suitcase.

#66: All right. I want you to relax and concentrate on him for a moment, and focus solely and completely on him. Look very carefully at him. Spend some time with him without reporting while I check with control.

PAUSE

#66: Describe for me then, this individual who carries the briefcase.

PAUSE

+32 #31: He's a....about 5-8...ears sort of stick out a little bit, and he's got a.....I'm gettin' these feelings of like a short hair, crew-cut, ah, blond, light blond, but it's a....not really a crew-cut; it's more like a.....a butch, but...guy's ears stick out. Salmon, caucasian complexion, almost cartoonish, roundness to his face, his head.

+35 #66: All right. Let's prepare to move now. Remembering your time window, remembering 100, 10 o'clock at night, 2200 hours at night, 10 December, move now up, up and over to the dark building I showed you in the photograph. Move now from the stadium area, 2200 hours, 10 December, move now in this same time window over to the dark building. As you arrive at the dark building ask yourself the question, what is it of intelligence interest in the dark building. Move into the area and describe your impressions to me.

PAUSE

~~SECRET~~

~~SECRET~~

#31: I'm in a...some sort of a basement room, and there appear to be, ah, windows, basement windows...and this...along the right wall exposed brick inside. Like it's ...not finished over...on the one corner of the building away from the stadium side.

#66: Okay. Move up to the next floor above you and explore that area.

PAUSE

#31: Now, there was two things. One thing is something at the end of a large room. It's against the wall. I couldn't tell if it was a staircase or something...and the other place is empty. The other thing was, is that there seems to be some roundness about this room, as though I'm in some sort of a, ah, ~~you know I could think that was like a track, but it's.....~~ something's flat and dividing goes around the outside of the....room. I can't figure out what it is....either a pattern on a floor, pews or or bleachers, I have no idea. There's nothing here.

#66: Okay. Take a look now, just as you did before, take a look at the next 4 hours, take a look at the next 4 hours.....

PAUSE

#31: Not a thing.

#66: Okay.

#31: Not a thing.

#66: I can tell from your voice that you've been at this quite a while and your concentration is somewhat off. Are there any final comments that you have before we draw the perceptions that you have had?

+38

PAUSE

#31: No.....the, ah....no there's nothing in this one building here. I don't know....

#66: All right.

#31: ...I sat and I waited and nots happened, and....

#66: All right. Would you like to respond to one more question?

#31: Sure.

+42 #66: Move in time holding on this building, move in time to 18 December2200 hours, at night, 18 December, and now report this area to me.

~~SECRET~~

~~SECRET~~

PAUSE

#66: Relax and concentrate now on this new time window that I have given you. Relax and concentrate on the new time window, and hold your response now while I turn the tape over. Hold your response now, concentrate, while I turn the tape over.

PAUSE

#31: I don't see anything happening, other than the possible arrival of an automobile with...something...think I was like riding in an automobile drive up. I don't see any, ah,.... Umm...I don't see something outside a, ah,...some sort of an entrance thing that's really divided. It's gotah, funny, it's got funny shaped sling shot shaped dividers down its middle. I think they're its middle anyway, but I see people coming and going like a reception or a rally or a...I mean impressed with the idea of publicity, meeting type of a situation, but that's a where the car came in. It's like a bunches of people standing around and a car drives up and people get out of it and they go in. Not a heavy, heavy crowd, but like a reception type feeling. Ah....

#66: Is the ^{re a}very center of focus personality?

#31: Well, yeah, like one of the people arriving in a car. Like this would have been, but, ah,....I'm going in and see what I get; just a minute.

#66: Ask them what they're doing there.

#31: Some sort of a valley of a minor party type of officials, and groups. Some sort of a neighbor, something to do with the neighborhood political thing. Low-level, low-level meeting. Get the funny feeling that it's sort of a brazenly open or whatever, but that this now, bunch of, nothing illegal about it or... I keep thinking like block meeting or something like that, but that's all I can get.

#66: Okay. I understand.

#31: May be only 20 or 30 or 40 peo...20 or 30 people here, and I still haven't been able to find out where they are. And, I know they're here, but I don't know what the room looks like or anything. It's like it's been...a town meeting thing....

#66: Okay.

#31: The central ^{guy is} guise. The feeling of a professorish, Umm...55 or 60 small, dark rim glasses, receding hairline, sort of a, sort of a quiet bolshevik, you know. The quiet, but brutal or mean in underneath. In other words, demanding and dictating, but even though he's quiet, and has this really neat academic air, and sort of bushy eyebrow. It's more of a prominent nose.

+50

#66: What is the... what is his profession, this, this one personality.

~~SECRET~~

~~SECRET~~

- #31: Keep seeing ^{him 'wid} wood beakers, and eye droppers in a white lab coat. Like a chemist or a pharmacist or something.
- #66: Okay.
- #31: I always see him sitting at a, a long type of counter, and like an old ^{white} light lineoleum counter somewhere. Something technical and glassware all around him, and like chemistry would be.
- #66: Okay. Fine. Focus your attention now, back here, on me in the room. Let's prepare to draw those eprceptions that you've seen. Focus your attention back here on me in the room, move your arms, move your legs, take a few deep breaths, prepare to draw.
- #31: Okay.
- #66: Certainly. All right. Yes, go ahead. I may interrupt you with a question. Go ahead. Drawing number 1.
- #31: Drawing number 1 is an overhead of the stadium area. As far as my trying, when you told me to go on up, try to figure out where I was, I sort of imagined, you know, I remembered that there was a north arrow right in the middle of the target. So, I sort of imagined that that north arrow was still there, and where had I been...to that. So, I would have been in somewhere up in the northeast end of the stadium. Now, this place where I spent most of my time was hanging aorund outside this damned wall down below the bleachers, but on the infield.
- #66: This is drawing number 2, now.
- #31: From there, this is drawing number 2, from there, I couldn't figure out if there were people in the bleachers or, I knew it was after dark because you had given me 10 o'clock time, and everything, p.m, didn't tell if the lights were on or not, but I had the feeling, first that there was a small group of people up there in the bleachers. This small, small group assembly came through a number of times, because even later on in the session it came through at that other place. All right. I kept asking myself the abstract, you know, what is it that's of intelligence interest here. Okay. Well, catty-corner across the infield is a large door that is large enough to accommodate a vehicle for track maintenance or something, to drive in there into the in-infield. The feeling of people upstairs in the bleachers sort of disappeared 'cause I impromptu went up there, sat down in the middle of 'em and looked down the bleachers, there were nobody, there wasn't anybody in it. Okay. So, I presumed that there were no pe- no small, was no small group of people outside. And, what I was interested in was on the other side of this buffer wall that runs around the interior of the bleachers, well somewhere in there, of course, typical, what you would expect to find in underneath the stadium there's some maze of some maze of some halls, and hallways, and..ninety degree curves and angles and hallways, and rooms and stuff like that, anyway, the only thing that I got was this...room, off a hallway, and some sort of a large door to it...that had three stacks of boxes in it.

~~SECRET~~

~~SECRET~~

- #31: The pyramid, parametal, stacks of boxes on pallets. The box which I've drawn in sketch 3, all right, and these are pallets. They were pretty neatly stacked, you know. It was like a display stack. Stack of stuff you'd see in the grocery store. I figured, well, umm, what is this stuff. This must be cleaning supplies. With my luck I entered the warehouse, you know, of the stadium or something like that. Anyway, I examined the contents of the boxes in great detail, and it was as though they were foot by about 8 inches by 8 inches. Made out of regular corrugated cardboard, and that contents was like a, small granular, but mushy granular blue. Not hard granular like sand, and not mush but no granular like re-fried beans. It's, it's granular like corn, ah meal to which water has been added to make tacos, tortillas, rather, you know. It still has the cornmeal granual but it's sort of mush. It's not a constant paste.
- #66: Okay. I have a question that seems obvious to me to ask this question, and I want you to answer from your perspective, because you went through this experience yourself. Is it possible that this material that you're describing is a packing material as opposed to the actual content of the box? That this is some sort of a, you know, these styrofoam packing.
- #31: No. I don't think so. No. I don't think, no, no. It was moist. It was not like dry styrofoam packing material.
- #66: Okay.
- #31: It was like I was trying to explain there with the tortilla, before you're having cooked the tortilla, but having made the tortilla. When you're using cornmeal it still has its granual and the granuals are puffed up because they have water and they're soft. The feeling that I got, coloring feeling that I got was that they were electric blue, it was an electric blue. Ah, how do I describe electric blue? The base color, when all of it was stuck together was a very, very electric blue. Eye catching blue, is what I mean. but as you got less and less and less of it, the color would fade out to be like Columbia blue. The other feeling I had was like if you scratched it, the nice smooth surface of the brick, let's say, if you scratched it, then what you..it would be darker on the outside where it might be a little dryer, but when you put your fingernail in it, that the stuff you scooped up in your fingernail would be a paler blue. Okay. Like running your fingernail along, sss--- putty, or not putty ...oh, that kid's stuff, silly putty, or not silly putty. What the hell is that machine that they make everything out of with clay?
- #66: Mr. Playdo?
- #31: Playdo! That's what I'm thinking of. Playdo. You know how playdo is? And, it was about the consistency of playdo.
- #66: Do you have the feeling being around this stuff whether this is edible or not?

8
~~SECRET~~

~~SECRET~~

- #31: No. I did not think it was edible. It never entered my mind that it was edible. It was something like cleaning. That's why I got thrown off on this, ah, cleaning supplies, or store room supplies feeling.....
- #66: But, at the time it never occurred to you that it was edible?
- #31: No.
- #66: Okay. And, looking back at it now.
- #31: No.
- #66: Okay. Let's go on to the next drawing.
- #31: Okay. So, anyway, there's these pyramids, three pallets, and in this room is where this feeling of sketch 4 happened, and that was, I think it was somewhere in that room, anyway, that, somewhere in the room, and I had the feeling it was like happening right on the other side of a pyramid from what I wa...that I was looking at at the time, and I sort of went, zipped over there, that there was this dusky gray, and brown crummy, round cornered, old-fashioned hard cased, suitcase. You know, the types that's got the wrinkled exterior on it from the mid-fifties type of thing, and, you know the type that you could almost nowadays expect to see tied together with a belt because the latches don't work on it anymore. Anyway, in the suitcase I saw the suitcase laying on the table, suitcase was opened, there was a layer of white in the bottom of the suitcase, as though..it seemed like it wasn't very far down from the lip. It was as though somebody had clothes in the suitcase, and the action that I saw was that smaller, brick sized..things like a red housing brick..about 8 inches by 4 by 4, were being taken from the pyramid and were being layed in on top of the clothes in the suitcase. As though, and they weren't being hastily packed or anything, but they were being layed in there. The bricks were being layed side-by-side. When I first looked at it, I thought it was, you know, it sort of reminded me of the classic bad guy putting the stacks of green backs in a suitcase before he makes the getaway. Right. But, that was just a fleeting idea, and I think it was just a conceptual type of message that was being given to me.
- #66: Okay. The objects placed in the suitcase were of a different size than the ones stacked.
- #31: Than the ones that are in the..the things that are being placed in the suitcase are smaller than the boxes that are stacked in pyramids on...
- #66: I understand. Okay.
- #31: I don't know if they come out of those boxes or where they come from. They, themselves come out of a stack. Okay. Four, five.

~~SECRET~~

~~SECRET~~

- #66: Drawing five, when I asked you to...moved you to the dark building...
- #31: The dark building. There was a empty basement room with lights along like street level at high, my head, and you moved me upstairs...I haven't done a sketch of upstairs in that building, but, then upstairs, I think, which would be ground floor level, there's some sort of a wide area. Like maybe a conference hall, but it's with a stair--- some sort of a staircase or ladder arrangement at one end, and some sort of a circular pattern like.....you know what I was reminded of that goes around this room, I was reminded of, ha, independent tracks that had walls in between them. Like.....let's say when you raise turtles, okay, when you raise turtles, you'd have to, you just couldn't put the turtle down and let it run, you'd need to keep it like a rat in a maze, you have to keep it in a maze, something, and there was some sort of partitioning of this.....business inside this room. Okay.
- #66: Okay.
- #31: Ah, like, umm.....okay, like a cafeteria line. You know. Where it goes back and forth, back and forth, back and forth, and it's got.....metal partitions in between the lines.
- #66: From what perspective did you perceive this?
- #31: From a low lateral (phonetic). Maybe 20 feet, 10 feet off the floor. Sort of looking away on my right, and I'm sitting here inside this room, and there's this thing going.....about five or six partitions stripes going away into the distant right.
- #66: Could they have been lines on the floor as opposed to walls?
- #31: I think they might have been.
- #66: Okay. You just described them as stripes. I wondered if you.....
- #31: Yeah, the pattern was striped but it appeared that it had depth to it. I don't know if that was true or false that it had depth to it. It appeared that it had depth to it. And, therefore having depth to it the stripes stuck up like walls, and the shadows stuck down like passageways. Okay, and six.....
- #66: Okay. We seem to focus on one particular individual there, and you had some things to say about him. You said he was academic and his ears stuck out, among other things. Do you talk now about this drawing that you've done, and your experience with him?

~~SECRET~~

~~SECRET~~

- #31: Well, what you had me do in six is describe the imagery that made me say that I thought that he had something to do with chemistry or some sort of laboratory work, and this is what I saw. I saw the guy that I thought to be him dressed differently in a right type lab coat, little bow tie, really nurdish, and he's.....like with an eyedropper dropping goop in some big, fantastically odd shape beaker on a desk, ta-working table, and to his right there's all sorts of glass beakers, jars and frames, and wires, and all sorts of other apparat---para-phernalia which...the likes of which I could never begin to draw....that's his occupation.
- #66: Okay. Going back to.....going back to him, when you perceived him at the.....
- #31: Meeting, or whatever it was.
- #66:the meeting, which was 18 December imagery....tell me about some of the people that were with him.
- #31: Men and women. They were dressed.....they were academics. They were academically oriented, as well. They did not come across as being an assortment of shipworkers, and dock workers and students, and teachers, and everything. They all came across.....but, this neighborhood feeling of a representativecross-section of a group of people around also came through.
- They were dressed up a little bit. Like you would to go to a Sunday afternoon church social type thing. You wouldn't wear levis down at the heels, shoes, you'd put your suit on, you know. Your business, your daily working suit on. They seemed to be middle aged. I'd say the youngest was maybe 30. I had the feeling that this, the room was 30 to 60 as opposed to teenager to any other level. This guy seemed to be some sort of a presence, but he was a real ba-, he was a mean guy. Likea martinetho, call him an academic martinetho, a peevish, in the sense that little ego centric, and expected everybody to do what he wanted them to do, and he was brilliant in his own right, and now it was time to knuckle down on these turkeys, and they were going to do it his way.
- #66: Okay. Returning your attention now to the work environment which you perceived, the beakers, and everything, do you have any impressions about his work associates.
- #31: No. I felt that this meeting was people that he was associated with, but no, I said that that's like a block meeting, but they're all the same type of people. It would be as though this guy comes from a.....oh lord.....an isolated environment in which everybody is all the same. You know. Like an academic community. But, when an academic community has a block party, committee meeting, or something like that, you don't have

~~SECRET~~

~~SECRET~~

- #31: stevadors and dock workers. They all happens to be academians, because they're the only ones that live in that community. So, even though the purpose of the meeting might not have anything to do with academics, you're only going to get academians there, you see. Because they represent the neighborhood type of thing. So, I don't know. That's the feeling is that they were all academics. This meeting was something like this bring them all together....bring representatives all together from everywhere else, and other than that, it's all conjecture. I don't know.
- #66: Okay. Returning now, specifically to your drawing where you draw him putting things in a beaker, you said, before, that you thougt, to you that looks like a chemist. Ah..... Do you have any strong feelings about other professions that this image is communicating to you? Any other possible professions that this kind of a thing might mean to you? You said before that you thought he probably was well educated, and brilliant in his own right, and so forth, and so on, and that he.....
- #31: Well, he could be a physicist, chemist, he could be a pharmacist. What else could it be?
- #66: Okay. So, that's.....that's the feelings that you get when you think about this image, is what you're saying.
- #31: Right. I don't get some guy who mixes paints for a living. It's you know, I don't get some guy that shoes race horses. I get some guy that's like in the physics or doctor or research chemistryah,...
- #66: Some sort of a higher level professional type person.
- #31: Right, right, definitely right.
- #66: Okay. Fine. Let's move on then, to your final drawing here, and explain to me when it was that you got this image. This is, I guess again, the 18th, 18 December?
- #31: I don't know. You had me working on.....constantly asking myself of asking the question of look for what is...you know.... what is of intelligence interest here. That was a good question, quite frankly.
- Ah, this is I think associated with the dark building, and I think it has something to do with the dark building. I don't believe that I got off the target.
- #66: In drawing 7.
- #31: In drawing 7. I have a car coming up and stopping and then somebody, and I think, it's maybe our guy here, who got me started, see, in sketch 6, this guy like arriving and going in through the building through a set of glass doors in the building front, and the building has these peculiar T-shaped

#31: blocky T-shaped ornamental, ah...pillars. Those pillars are outside, and I did not..they might hold up a roof, but I can't believe they held up a roof, because I thought they were ornamental pillars outside in this...in this...concrete ...area here, between the road and the building. All right.

#66: What is it that attracted your attention to these strange

#31: Well, I'm sitting around, you know. You're telling me, tell me what ha-, tell me if, you don't, you didn't say tell me if anything happens. You just said tell me what happens of intelligence interest in the next 4 hours. So, I'm okay, you know, sock it to me, what's going to happen, and this ...I see this car drive up, and this feeling that the guy gets out and walks in through the front door.

#66: Okay, but again.....

#31: Now, if that's of intelligence interest, I don't know what message is being conveyed.

#66: Okay.

#31: I think that that.....give me a chance, huh.

#66: I'm interested in, I understand you're response. I'm interested in what is it that attracted your attention to describe the T-shaped objects or this one shape object.

#31: It's the area. That's the only reason. It's a characteristic of where this event occurred. That's the only reason I've written it down.

#66: A key descriptor.

#31: It's a key descriptor is all it is, and that's, umm....you know. Anyway, the guy goes inside, and that's when I began to get the feeling of this little meeting that this martinet was having, that had these other people around that were 30 to 55 years old who were all sitting around and he was sort of....getting his.... getting his jollies telling these people what to do. The neighborhood block party feeling, block meeting feeling, you know. So, the only reason the T-shape thing.....

#66: Again, I.....

#31: ...so 7 actually precedes 5. I mean it precedes 6. It should go 5, 7, 6 in order....

#66: I understand, because I asked you about this profession after this point in time. Ah, I have a couple of questions about drawing 7 then.

#31: Okay.

#66: Umm....again you mentioned that he, this feeling of a block party. Am I understanding you correctly that you used that term to describe a group of people with similar identities and goals.

#31: No. I used that term as though it's like a city block.. warden meeting.

#66: So, that you.....

#31: That's what I'm talking about. Now, it just so happens that they all have similar ideas and goals because they all come from an area which is academic in nature.

#66: Okay. So, you do feel then there is some geographic.....

#31: Contigu.....contiguity

#66: Contiguity in these people.

#31: Yes. Right.

#66: I understand now, okay.

#31: Yes. That's what I'm trying....when I say block party I mean like block warden meeting, business not associated with real academic professional business, but some other thing that has to be done on a monthly basis or.....

#66: Okay. Does this man on here that you've described, this professional man, have any authority in the situation he was doing?

#31: Yes.....

#66: Formal authority or.....

#31: Yes.

#66: Formalized authority. And, what is it you experienced that makes you say this?

#31: 'cause he had them all under his thumb. He was the....he didn't have to ask if they would do something. He didn't have to be diplomatic about having something done. He was, all right, now we're going to talk about this.

#66: Okay. Ah, when I asked you previously to focus on a, a focus personality, was there someone on which these people were focused? You said there were like a group of people. When this man arrived in the car, do you feel he arrived alone?

~~SECRET~~
~~SECRET~~

- #31: Yeah. I do not feel that he was chauffeured there. I feel that he was taxicabbed there, and that he arrived alone.
- #66: Aha. And, in the meeting itself, does he share this authority that he has over these people with other individuals? Just from your feeling of the attitude in the meeting.
- #31: I'm trying to remember who I saw up on the dais, or whatever. Up front everybody was looking at..... There was someone else up where he was, where he was like at the one end of the room. It was almost, somewhat of a confrontation type thing, you know. People looking at each other-s, sittin gacross from each others, and I seem to recall there being a feeling of one or two other people, but lesser sitting on the left side. One of them was a woman, and then on the right side was the rest of the people that were getting dictated to, but that he in reality was the biggest guy, but like the woman and the other person at this meeting might be like the, I don't know, local senior committee members. So, therefore they get the right to sit up there with this guy who comes in, who is the non-local senior, super-senior committee member, and so it's a matter of protocol that they would sit up there. But, not necessarily shared leadership.
- #66: Okay. These T-shaped structures. I'm sorry. You called them sling shot shaped structures. Do you feel that as they sit there in this entranceway, are they a permanent fixed thing or are they temporary in nature?
- #31: Aha....two rows of, I thought two rows of them, and they were permanent. I had the feeling they were made out of concrete, and that they were sunk in the.....sunk in the concrete in this little walkway there.
- #66: Okay. An integral part of whatever was happening right there.
- #31: Yes.
- #66: And some, and a key feature....
- #31: And a key feature by which....
- #66: (mumble)
- #31: Yeah.
- #66: Okay.
- #31: With or without a roof. I don't know.
- #66: You draw there in 7, ah, him arriving in the car, and you saw some people leaving as he's arriving, and so forth, you talk about people coming and going.

~~SECRET~~
~~SECRET~~

~~SECRET~~

- #31: Yeah. There are people coming and going, and there are people waiting. There are groups of people on the right and left of the street, of the scene.....25 or 30 people on the left and 25 or 30 people on the right. Not 2 and 3 on each, but larger numbered, but not a mob, but a bunch of people who are there watching the arrival and the departure of these people.
- #66: Aha. Now, during the meeting itself, do these comings and goings continue? Do people come and go during the meeting itself?
- #31: No. I don't....I can't answer that. I did not thing, I didn't, I had the....I didn't have any feeling that would make me say that the comings and goings continued. I had the feeling it was a fixed group in time meeting.
- #66: Okay. I know that we didn't ask you to pay attention to that at the time. I just wondered if you recalled.....
- #31: Yeah, but I didn't have.....no, I didn't have any feeling of fluidity of the group. I had the feeling that it was.....I sort of assumed that it was static.
- #66: Okay. Do you have any feeling about the identity of the group of people at all?
- #31: No.
- #66: Okay. I don't think that there's anymore information that's going to be available to us. So, if there's anything that you have to add about your feelings about this session, how things went, is there anything that you can, ah.....
- #31: Aha. I was very..I was deep, and I felt good, but I kept looking for something, and there was nothing there. Very little there to talk about.
- #66: In asking yourself the question, what's of intelligence interest, you didn't get very many answers, I guess that's what you're saying.
- #31: Yes. That's right. Knowing also, of course, as we know, that that's a dangerous question to have to ask yourself.
- #66: Certainly.
- #31: Because you create your own interest that you look for.
- #66: Sometimes we have to use that methodology, but we don't.....
- #31: Yeah, I understand. That's why I'm sort of back out of the situation here, because I just could, did not see anything, you know.....
- #66: Okay. Well, that'll do it then.

TAB

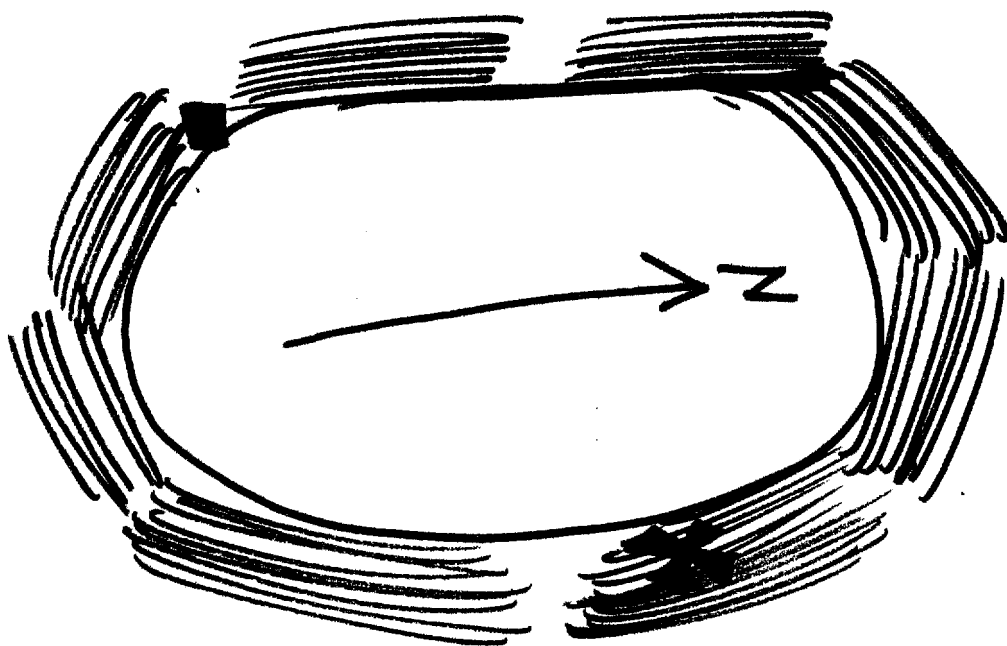

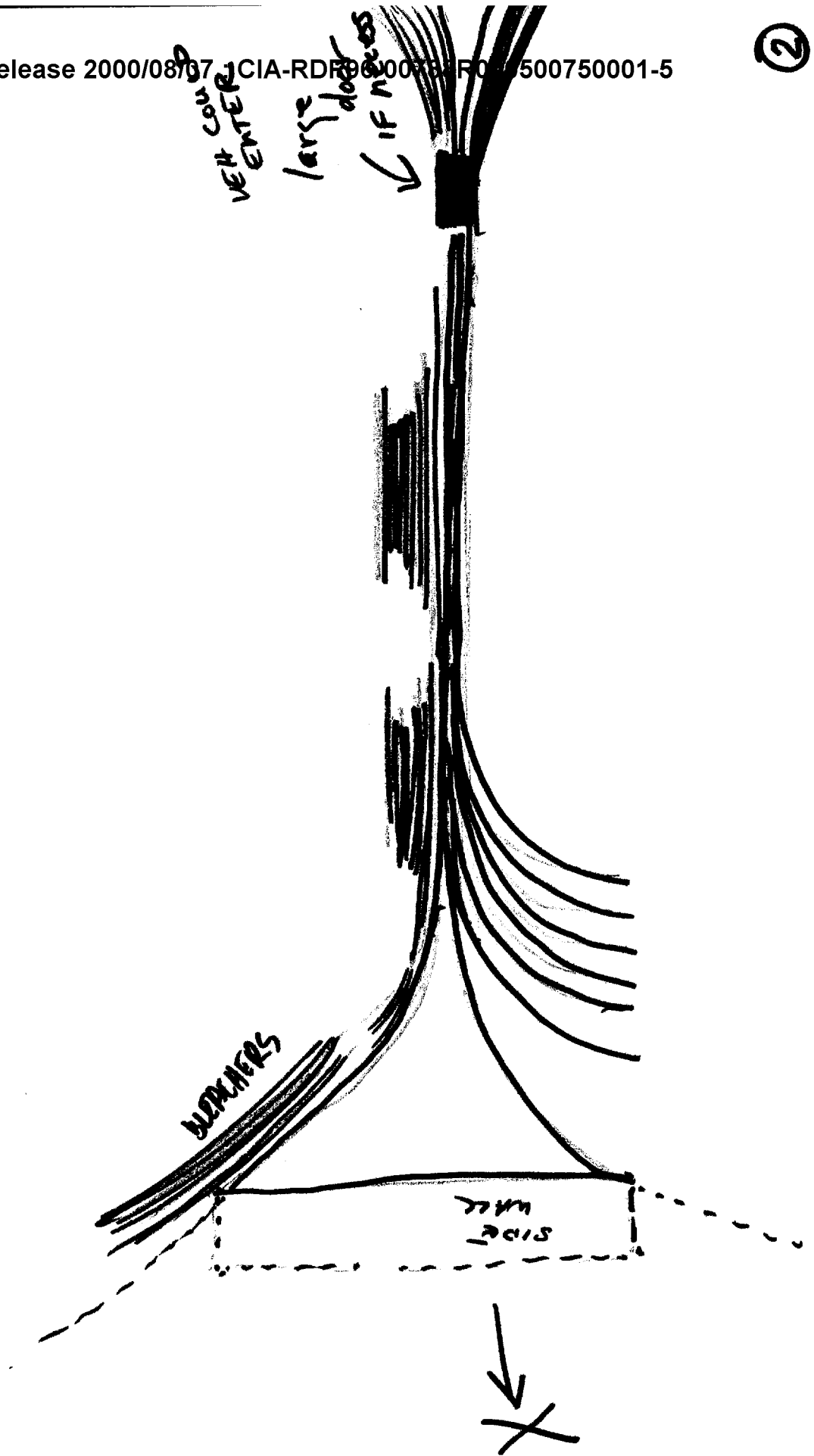

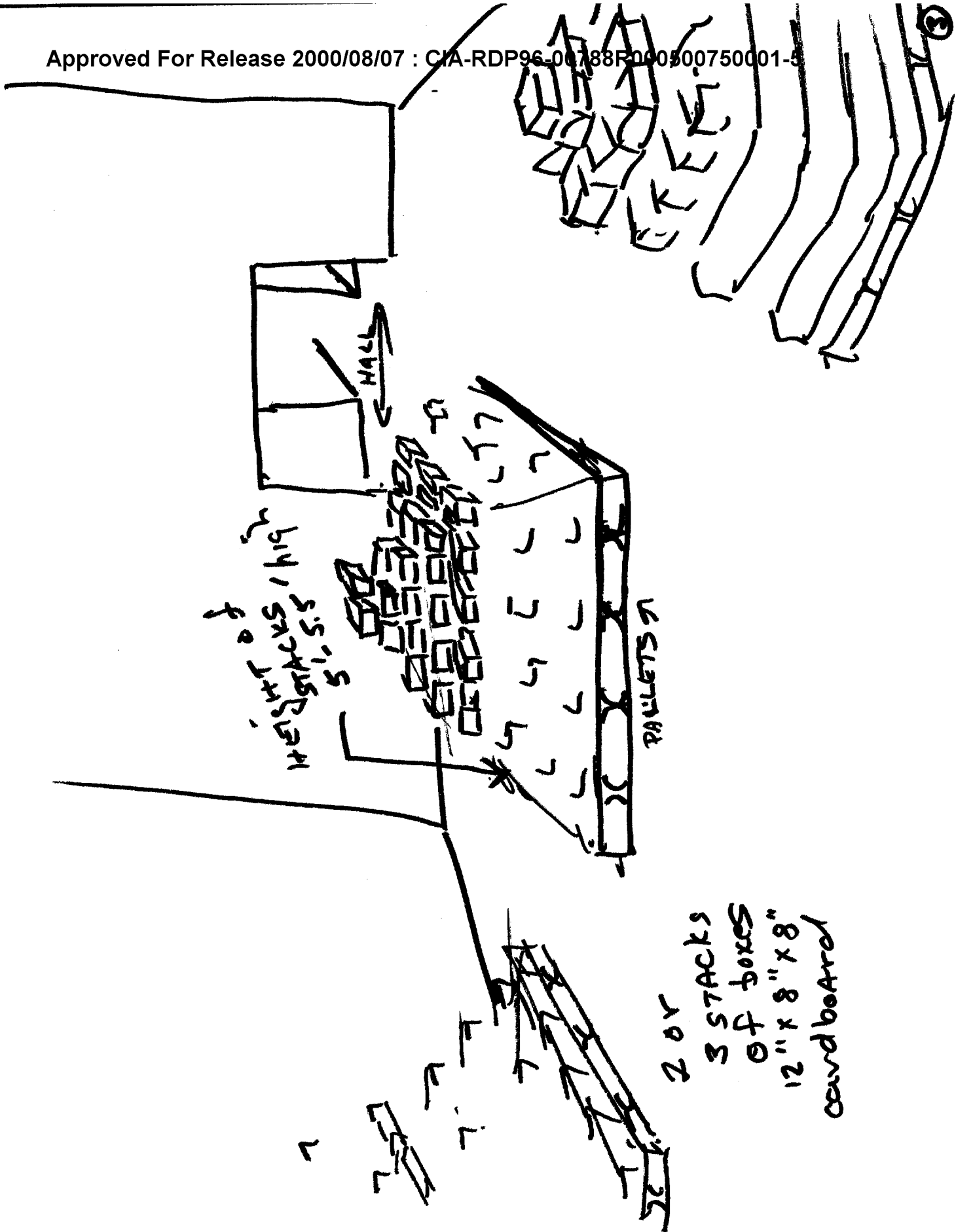

2 or
 3 STACKS
 of boxes
 12" x 8" x 8"
 cardboard

CUBES of
STUFF in IGE.
STACKS being
placed in old
STYLE SUITCASE
GREY MOTTLED w/
brownish
STRIPES

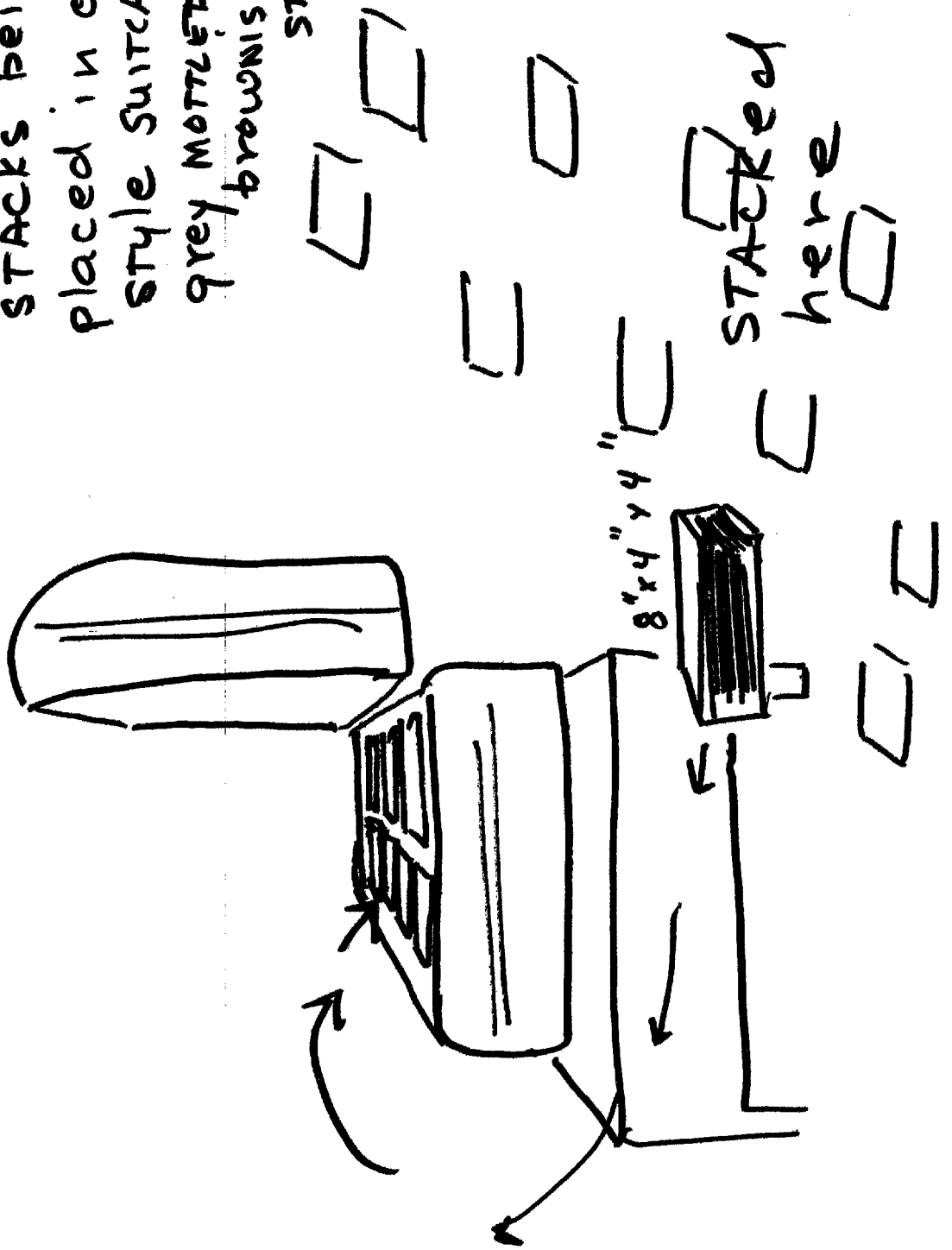

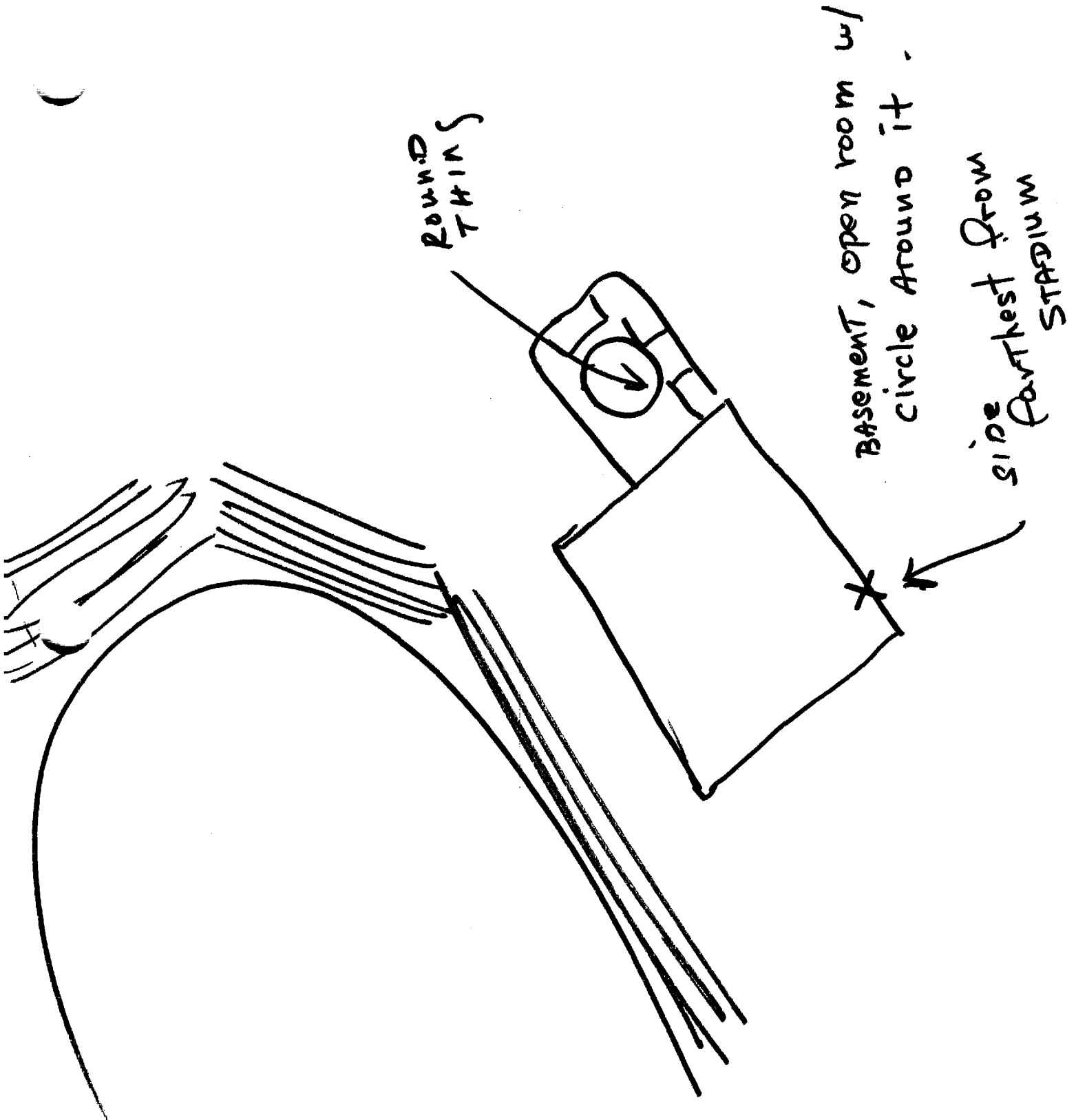

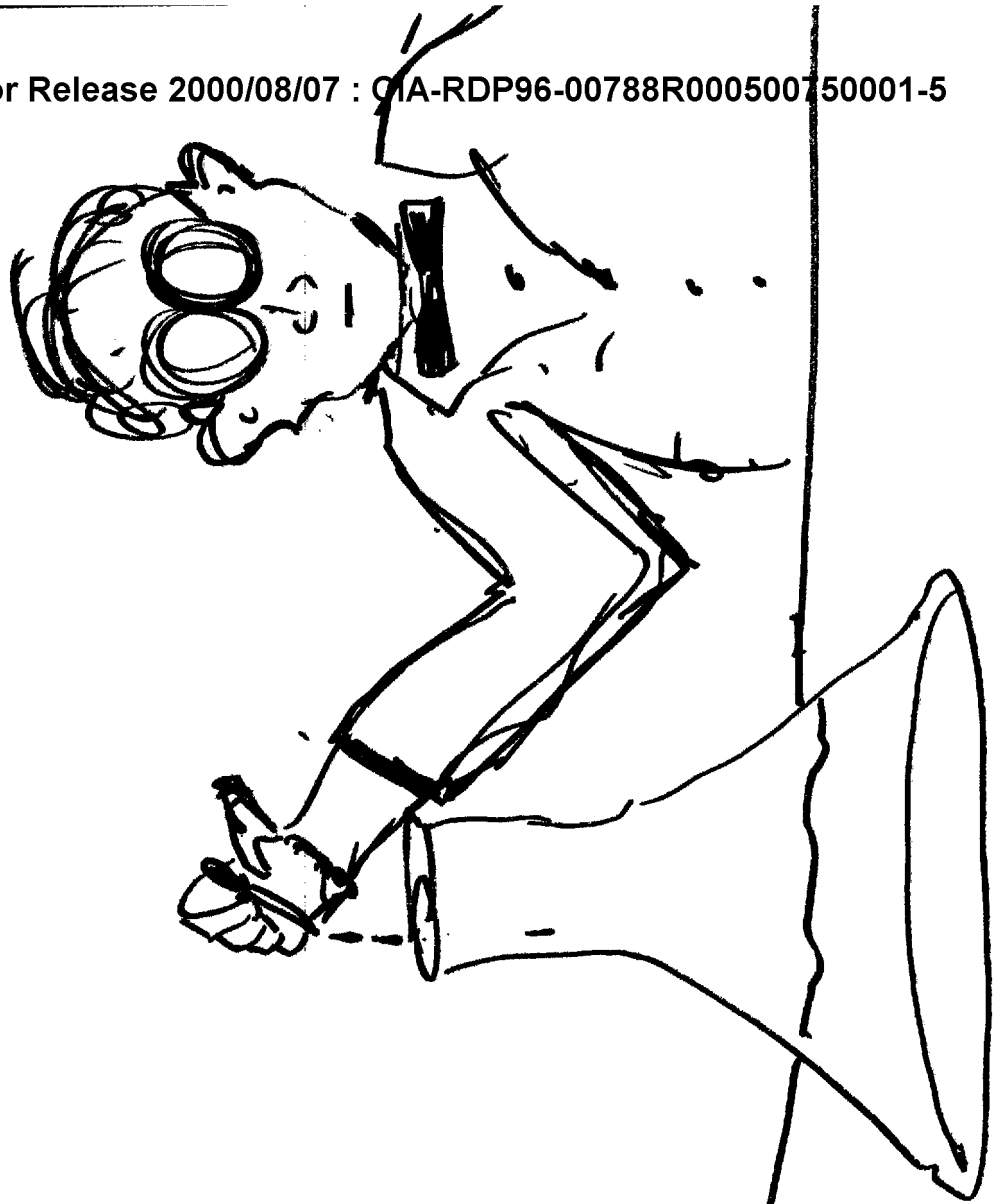

"MAN IN WHITE LAB COAT
USING EYE DROPPER TO PUT
LIQUID IN A BEAKER"

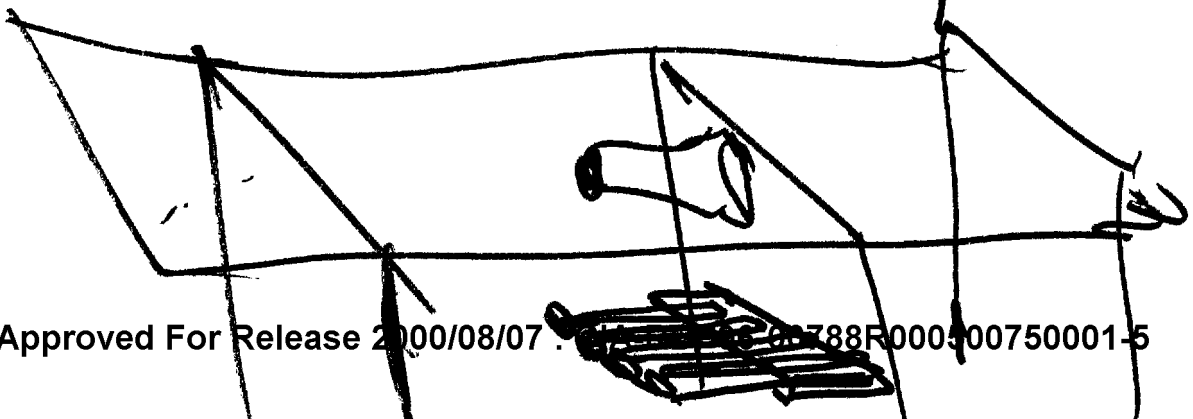

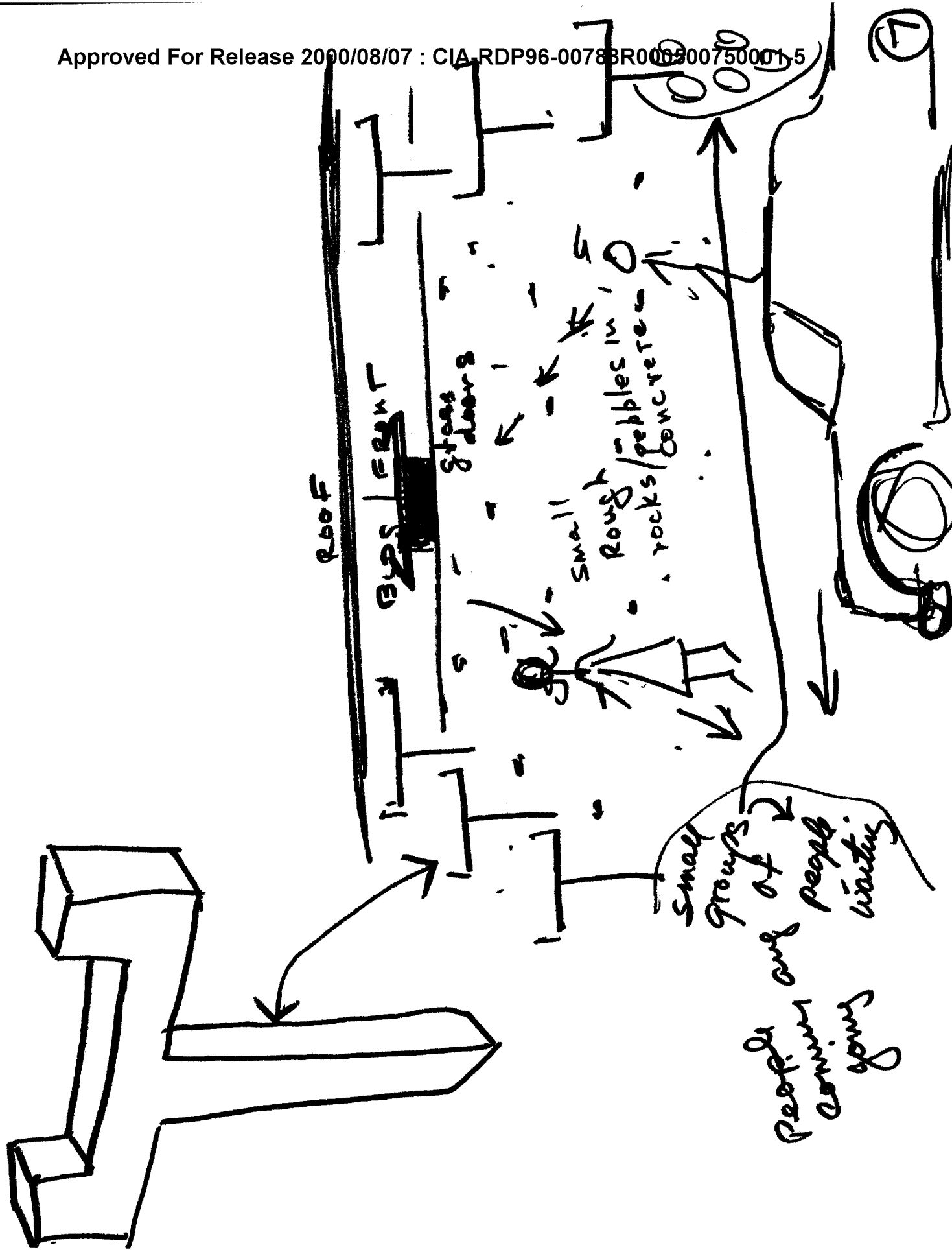

TAB

~~SECRET~~

TARGET CUING INFORMATION

REMOTE VIEWING (RV) SESSION DC-49

1. (S/NOFORN) Prior to the session the remote viewer was shown overhead imagery of the target area and was told that his target would consist of the stadium, a dark building and a light building. and a light building. The imagery is not included herein due to its classification.
2. (S/NOFORN) During the session the remote viewer was asked to focus on the time windows 102200 Dec 80 and 182200 Dec 80, and do four hour time scans. The viewer was directed to focus first on the "stadium" and then the "dark building."
3. (S/NOFORN) During the session the remote viewer was asked to elaborate on portions of his perceptions by the interviewer as directed by the control analyst. See TAB C.

NOT RELEASABLE TO FOREIGN NATIONALS

~~SECRET~~

TAB

~~SECRET~~

CONTROL ANALYST'S QUESTIONS

18 Dec 80 REMOTE VIEWING (RV) SESSION DC-49

1. Stadium
2. Dark Bldg
3. Light Bldg

Start time: 1100 Target Time: (2200, 10 Dec 80)

TIME

1115 VU: Boxes
 MON: Look in boxes

1120 VU: Bluish, packed snow
 MON: Move away a few feet

1125 VU: Block bricks
 MON: Move back to infield, scan 4-5 hours ahead for EEI

1130 VU: People
 MON: Where do they go?

1135 VU: Describes 5'8" man
 MON: Move to dark building

1137 VU: Basement room
 MON: Move up one floor

1140 VU: Large room, track, no activity
 MON: Move 4 hours ahead

1143 VU: No activity
 MON: Move to 18 Dec

1148 VU: Car people
 MON: Ask them what they are doing

1150 VU: Boss is described
 MON: What does he do?

~~SECRET~~