

~~SECRET~~

INSCOM  
GRILL FLAME  
PROGRAM

SESSION REPORT

NOT RELEASABLE TO FOREIGN NATIONALS

~~SECRET~~

ORCON

CLASSIFIED BY:MSG,DAMI-ISH

DATED: 051630ZJUL78

REVIEW ON: May 2001

GRILL FLAME

Copy 1 of 2 copies

~~SECRET~~

SUMMARY ANALYSIS

REMOTE VIEWING (RV) SESSION DCC-55

1. (S/NOFORN) This report documents a remote viewing session conducted in compliance with a request for information.
2. (S/NOFORN) The remote viewer's impressions of the target are provided as raw intelligence data, and as such, have not been subjected to any intermediate analysis, evaluation or collation. Interpretation and use of the information provided is the responsibility of the requestor.
3. (S/NOFORN) The protocol used for this session is detailed in the document Grill Flame Protocol, AMSAA Applied Remote Viewing Protocol (S), undated.
4. (S/NOFORN) Following is a transcript of the viewer's impressions during the remote viewing session. At TAB A are drawings made by the remote viewer reference his impressions of the target site. At TAB B is target cuing information provided the remote viewer.

NOT RELEASABLE TO FOREIGN NATIONALS

~~SECRET~~

~~SECRET~~

TRANSCRIPT

REMOTE VIEWING (RV) SESSION DCC-55

TIME

#14: This will be a remote viewing session for 20 May 1981. Mission time is 1400 hours.

#31: ~~Jest.~~

#14: All right #31, it's now 1400 hours. You have a sealed target envelope with you. In this envelope is a geographic coordinate which locates the target. At this time I want you to relax, focus on the target and go to the target and describe your surroundings.

PAUSE

+03 #31: Feeling of a.....a webbing net..vertical block...and scaffolding all around it...

PAUSE

+07 The dominating is a, uh...larger rectangular block...like a building under repair..or construction... (Mumble) up front, then it's got a....some trees around it and cleared area. Seems to be very tall..ten stories or so... Round thing on one...globe up on top... I'm getting a... long and skinny look the other way. On the end near me is a..will be or will be some time a globe, some sort of a tall whip, a tall, straight skinniness comes up out of the scaffolding at one side.

#14: Tell me more about the globe.

#31: I don't think it's there yet. It will be there.

#14: Okay. Tell me more about it. What it is...

#31: It will be smooth and white. I mean, it's not scaffold like, it's..the rest of this thing, it's gonna be a smooth globe..built on like a radome on the end of this, the upper edge of this thing. I'll get inside in a minute.

#14: Okay.

#13: It's very large. Compared to the proportion of the building it seems to be maybe, itself to be a story and a half to two stories in size... There's not really a...feeling I first had is wasn't really a globe, so much as it was

~~SECRET~~

~~SECRET~~

- #31: a out-swinging curved appendage that looked like a globe. It was globe like, but attached up there. It's feeling like a stack on a steam ship. The old vent stacks. Sort of a swerving, curving...
- #14: What's the function of this thing?
- #31: It's a.....it contains and protects. But inside the thing it's like something that's very expansive but very unsolid. The inside of this thing is like...a lot of the inside is just air. I have feeling of very irregularly shaped booms and beams that go back and forth across the interior space, in a very irregular geodesic type manner. Things that stick way out from center mass, a very loose boom that sticks way out but it's covered by the environmental cover. The thing very acute angle to them.....small, look like they're metal..things that are like triangular in thickness and long with this cross-hatching of like a..to strengthen it. It's hollow..can see through it, but it's used to hold something out on. Maybe used to like hold something out on the end....
- #14: Is this device important to the-
- #31: It's like an array. The thing is the..the displaying fingers and everything is used to hold an array of things out, like I had this feeling of like an upside-down palm with the fingers splayed, and with the fingers splayed out, and then the fingers being connected by webbing to make a shallow bowl shape. But the fingers are just the framework that holds the webbing out there. Let me, uh, get my focus back for a minute.
- +15
- PAUSE
- I, uh....I definitely up high..up on the top of this thing.
- #14: What does this device do? How does it function?
- #31: I, uh..... This thing is concerned with something which is a target horizon. And I have this feeling of things rising up over the horizon..and being concerned with pin-points of a..things that have gone to the seat of the purpose. And I'm looking at a display that has a blackness to it and a curvature to it like the earth. And I'm observing the pinpoints of light rising up off the edge..determines a target horizon. And this thing is concerned with... I had an earlier feeling, I don't know if it was overlay, just before this feeling of this was it was one of several, possibly four. It was concerned with communicating with and steering these things which later I found rising up on the target horizon. Very strong feeling of communications with satellites..the manuever and control of satellites. It'll come up again, give me another minute.

~~SECRET~~

~~SECRET~~

#14: Okay.

PAUSE

+23 #31: I feel that I'm inside. And the long and narrowness continues. On my right is a large flatness of screen, looks like a large screen that is looked at by people in the floor..people in the floor or on the floor. That is where this display comes. I'm like reminded of many things of data coming in like a war room. Has many visual aids and things and the screens are overpowering. This is not that, this is like....this whole big screen is a..encased in a building. And the whole thing, the whole center structural thing is..and it's free standing inside the building....

#14: Describe the people at this location.

+30 #31: And it's slightly convex, I mean, concave. Feel slight curve to it. And that the curve is designed to sit inside the box. A parabolic curve that fits inside the box to give somewhere many thousands..several thousands of miles away a focus, a point, focus point... And you can calculate that by merely using the dimensions of the building..the size of the structure is the curve. And it curves in the direction that the...the back of the curve has the round thing on the left. Looking at it from the rear the round thing is on the left. Okay...

#14: Describe the people at this location.....

+32 #31: There are two types here. There's very clinical laboratory technical feeling of operators, people who operate and push the buttons.. People who sit in the pits. They're like amphitheater areas, surrounded by banks of some tele-screens. And these people are wearing a...a clinical white.. There are observers that wear brown uniforms. They're heavy woolen..deep Soviet brown, Russian brown, olive brown uniforms. They sit like they sit in a...and observe what the...they observe what's happening, what's on the screens. And they observe and they, uh, are more casual than the technicians. They like, uh, are like, uh, like our officers would be, uh, observing.. But there're not a lot of them. There are..anyone, seems like any one condition only has maybe three or four that, uh..are there to, uh..give orders. They don't call up the data, they don't monitor. They observe the monitoring. They say, you know, get me, uh, let's take a look at this and the guy calls it up. And it's concerning various targets. Again, it's this target horizon thing....

#14: I want you to pick out one of the individuals, one of the individuals in uniform and describe him in detail.

PAUSE

~~SECRET~~

~~SECRET~~

+35 #31: (Mumble) My entrance appears to be some sort of an overhang  
+36 thing here. It's almost like I'm walking into a department  
store at the bottom of it. The guy is sorta youngish.  
Um, very matter-of-factly, uh, realized that he was assigned  
to Soviet missile forces. Just missile forces obviously  
came into mind. I'm getting a watch officer feeling, so  
let me work on him for a minute.....

I'm, uh, young, uh, 28 or so, I'm a captain, a young,  
young like captain. I'm in an elevator that is exposed and  
that travels up and down the height of the building on a  
out of focus side, on the right side. I can see the exposed  
thing out in the face of my elevator. And I have to do this  
as a matter of routine. I control the elevator myself, I  
think I got my left hand on it, on the control thing. I  
think I only go up and down and I'm off to the right side  
facing the curve. For some reason I got...that I'm out of  
the focus plane, I'm away from it so I'm safe on the right  
side. Like if I went up and down the middle of it I'd get  
fried or something would happen to me, so the elevator only  
goes up the right side. And maybe one on the left side,  
but not up the middle.

+38 I'm, uh..... This is some sort of a high pressure,  
elitist job that requires exacting, accuracy and thoroughness,  
high discipline. The name I'm getting is like Plotkin..  
Plotkin or something like that... Feel like I'm about  
28 years old. Young Turk stud.

#14: What makes you say young Turk?

+41 #31: Turk...five percenter is what we call 'em... Thing keeps  
having a..the thing that I'm looking at keeps having a..  
thin solidness to it, like I'm looking at a screen...

#14: What type of screen?

#31: It's hard to tell. It's like it's...the screen itself is  
like one continuous three dimensional object having the  
curving face, then having a rear to it. And it's like a  
sandwich, like a curved sandwich. It's connected all the way  
around its edges to make it one object. And the sandwich  
is, I wanna say about...maybe 15 feet or 20 feet thick.

#14: Okay #31, I want you to maintain your focus at this time  
while I change the tape. Hopefully as quiet as I can.

All right, we're ready to go again. Do you have any feeling  
for where in the world you're located?

+45 #31: Get the, uh.....Oh, I, I, I....I'm, uh, in the, uh,  
Soviet Union. I'm, uh, to the northeast of Tashkent...is  
up there, Tashkent is off the..my feet. And I'm looking

4  
~~SECRET~~

~~SECRET~~

#31: up.. If I was a clock it's at..Tashkent's in my naval and where I am is up inside the main continent part, continental part..and about a one..one o'clock or one thirty direction. And I'm not far enough east in the Soviet Union to be considered to be in the outlands, way the hell and gone out into nowhere. I'm not in White Russia, I'm out in the steppes. And, uh, I don't know if this makes any sense at all but feeling of Lake Baikal is at my belly-button. Then I'm at about a ten o'clock, ten thirty direction from Lake Baikal... But I'm not as far from Baikal as I am from Tashkent. I'm more on the, uh, I'm on the right side, I'm over in that area. I don't know..a dot in another big blur, but I can't tell where it is...somewhere off in eastern Russia, southern eastern. That's all I know.....

+47

This is rather difficult for me, 'cause I keep getting overlay from attitudes and feelings of a project I worked earlier, which was some sort of a similar..similar thing about a big structure out in the middle of nowhere.

#14: I understand.

#31: Is very, very reminiscent of that type of, that target.

#14: In what way does this remind you of that target?

#31: The massiveness of the structure, the scaffolding construction idea, something to do with communications, the rarity of the shape of the structure and the isolation of the structure and the feeling that it's one of a group of huge things set up for fixed communications of some kind. It's all extremely reminiscent. The feeling of a large screen thing, somethin' to do with communications. It's all very much like that. And I worked it about a...eight months ago or so, just after we got here.

#14: I want you to quickly take a look at this complex and describe the make-up of this complex. Describe the complex itself.

#31: Well, I get a....I get like an open space around it, which is not nearly as large as the actual..thing itself. It's like the object it so tall and wide that, uh, a normal lawn around the building really looks miniscule. Feeling that that's sorta long..there's a chain link, feeling of a fence that delineates the cleared area. And then that there's woods around it entirely and that this is carved out of a wooded area, forest area. Uh, it's long because the building is long and that the end opposite the end that has the round bubble on it is the end that you drive into it. And that you walk in on the side that is in the curve, not the back of the curve, but the front of the curve. Uh, I don't know, I'm gonna have to pull the plug here because of the, it's essentially a long, enclosed area. And, uh....this isolated feeling is still there. It's accessed by a road that drives

~~SECRET~~

~~SECRET~~

- #31: through the woods for some distance from some other part. Like maybe a complex of buildings that houses the personnel or something. They appear to be lower, and three or four of them and they're a quarter of a mile away or something like that. Feel like, the idea was like barracks. I gotta, I'm comin' out of this.
- #14: Okay, we'll pause at this time.
- #31: That's all I got, #14.
- #14: Okay.
- #31: Okay. First things first. When I acquired the target I had the feeling that it was in a construction phase. I had this feeling of, caused by a feeling that there was some sort of scaffolding pattern around the target building, which I've sort of drawn in sketch one, and showing it in sort of a stage of partial construction. I don't know if really is that way, 'cause then immediately I had the completed feeling of sketch two.

Very mammoth, ten or so or more story, simple rectangular box, hiding inside some sort of a screen shaped device, like a radar screen. And having on top of it a big goose egg, like a radome, which itself was a weather container for a cupped, hand shaped series of extensor scaffolds that held out an array of wires or netting that was the intricate part of the antenna or whatever it was that was inside this dome. Uh, understand what I'm saying- the thing that's being held up is not strong enough to stand by itself, so there's this interior extensor rod arrangement thing that supports the thing, supports the flimsy parts to keep them from falling apart and falling in and collapsing. Surrounded by woods, uh, forset type thing, isolated feeling, grass infield, surrounded by a fence, like a restricted area type fence.

Okay, sketch three is a cutaway of what is inside the building. Uh, the under- the thing I wanna get across is that this huge screen is built right on top of a sub floor that contains all the operating equipment, computers, heavy electronics are in the very, very bottom floor, integrally tied to this big screen feeling. And that the building around the screen is essentially free-standing. Both things are free-standing. The screen stands inside the building in a way so that people can climb around catwalks and go up and down elevators between the screen face and the building wall. Okay? Uh, you know, I don't know, it's sorta hard- there are no floor, I'm not, there's no floors and interior walls to the building. But the screen is attached to the building, and people can climb around it. But essentially it's just one big empty box with something inside it.

~~SECRET~~



~~SECRET~~

- #31: Uh, sketch four is a side view, um, showing the perception that I had of this watch officer, this guy that I referred to as a young Turk, young Turk meaning, you know, a young stud officer, five percenter, top of his class, really politically reliable and gung-ho type of a guy. That's that type of guy that I, uh.. And the elevator is, like when he takes over a shift or something he would have to go up and down the elevator and examine the screen and make sure it's okay.
- #14: So it's more of a radar type screen that it is a viewing screen.
- #31: Oh, yeah, it's much, it's a, it's a s, not it's not radar.. or is it radar?
- #14: Well is, uh-
- #31: It's, uh, it's hard, I won't, I just won't say anything about it. It's, you don't look at the whole thing, but the whole thing does have something to do with the ultimate end product that you look at, like a radar screen, which would be associated with- but it also transmits, there's also this feeling of transmission involved. Which obviously radar transmits and reads its bounce back. So it may have something to do like that. But I agree with what-
- #14: The only thing I was saying, the screen is not like a CDR?
- #31: No, it is not the CRT.
- #14: Yeah, okay.
- #31: It is the transmitter receptor. Down in under it, down in this box at the bottom of the screen where I've written offices, electronic, that is where the TV, the CRT feeling, the working pit, the computer terminal call up data bank, electronic technician people in white clothes and all the associated desk machinery and electronics, that where that is, down below. Um, there are two of these elevators. One at either end of the building and the domes on top. Okay.
- And five is the overview. Feeling that this is an isolated site, but that it is connected like with maybe a dirt road, quarter of a mile to a mile away with an admin support area which would have billets and where the people would sleep that work at the site.
- Six is a shot of down below in under the screen in the offices area. This is like a amphitheater pit. The men with the white coats, the technicians who work on the equipment and monitor it in a technical basis, uh, respond to the men who are in uniform who observe what's happening, and they are more the recipients of the data being provided. And these men sit- it was sort of classroom like, almost. The guy

~~SECRET~~

~~SECRET~~

#31: with the white coat sits down at the bottom of the amphitheater. He responds to the guy sitting in the curved seats, the curved area of seats around it and above him to the rear and calls up data on these big screens, which are not, now- to clarify your point- these big screens that these folks are looking at are not the big screen up above them. This is in between the up above big technical screen and the ground floor is like a sub, sub office building, office area on the face of which is like, you know, it's screens and big, huge cathode ray tube type screens. It's either TV screens and monitors or just simply a computer CRT, computer driven CRTs, which puts up schematics maybe. Not real picture, but maybe schematics. So it's sorta, I don't know which is which. But the thing that is being displayed on the screen is the word target horizon came into my mind when I was looking at this thing. Like they were observing a target rise above the horizon some many of thousands of miles distant. And were, and it was, the feeling was that the target was manueverable from this place, and that this is where they would- because this big screen could transmit as well as receive, they would activate some sort of guidance instructions to that target. Like a satellite. Very heavy norad satellite type feeling about this whole thing. And the thought of these manueverable killer satellites came into my mind. Like this is the place where they would do something that had to do with Soviet killer satellites. They would direct it and guide it from here when it rose above the target horizon, it would dump the data into it. Somethin' like that.

Up at the top of sketch six you can see the bottom edge of the huge vertical screen, that's the thing that goes up ten stories... And the people in the seats like sit and look at the TV screens and decide what to do and pass directions and order commands. Very subdued, not like a military, but more academic, like well, why don't you call up XYZ now, let's take a look at that. XYZ coming up on the screen sir, you know, and here it is. You know, the guy calls up the data and he displays it for him. Anyway.

Now, the feeling of active as well as passive. I had the feeling that there were two aspects to the whole coin here. One was that it looked and saw things moving above the horizon, but at the same time this complex could communicate and direct actively the things that were coming up of, on the horizon. And that's where this manuevering idea of killer satellites came in. Okay? Um...

Oh, at the very beginning I had- towards the end of the session I had some overlay. The very first part of the session, when I looked at this thing and I started to describe it in amongst the trees, I had the feeling that this might be the finished product of a session that I did about a month

~~SECRET~~

~~SECRET~~

#31: ago in which, um, I had the feeling that I was up north, Soviet Union, western part of white Russia on a seacoast, on a windswept seacoast with woods. I don't know what the session number was. And that this thing, this other target that I was doing stuck out on a nodule of land that stuck out into the water. And it was under construction. The more and more I got into this target though, I discarded that feeling. Then at the end of the session when I was asked where this thing was, which is sorta peculiar because I was targeted against coordinates, presumably we know where the coordinates are- I had the feeling that I was in mainland Soviet Union, uh, and I described where I thought I was. I gave some sort of clock readings, a name, everything like that. But the confusion is that I was having this overlay, or having this concept that this was just one of a group of three or four. Okay. Which is the overlay from the one eight months ago. Eight months ago I was targeted against some sort of a facility in which there were three of them and they wanted to know if there was a fourth one. And it gestaltically was similar. Huge type scaffolding structure, obviously used for some sort of communications. And in that session I said that it was in the same area. So the location area might be pure bullshit, overlay. Okay? That's all I have. Any more?

#14: Sounds good.

#31: Okay. Goodbye.

~~SECRET~~

**TAB**

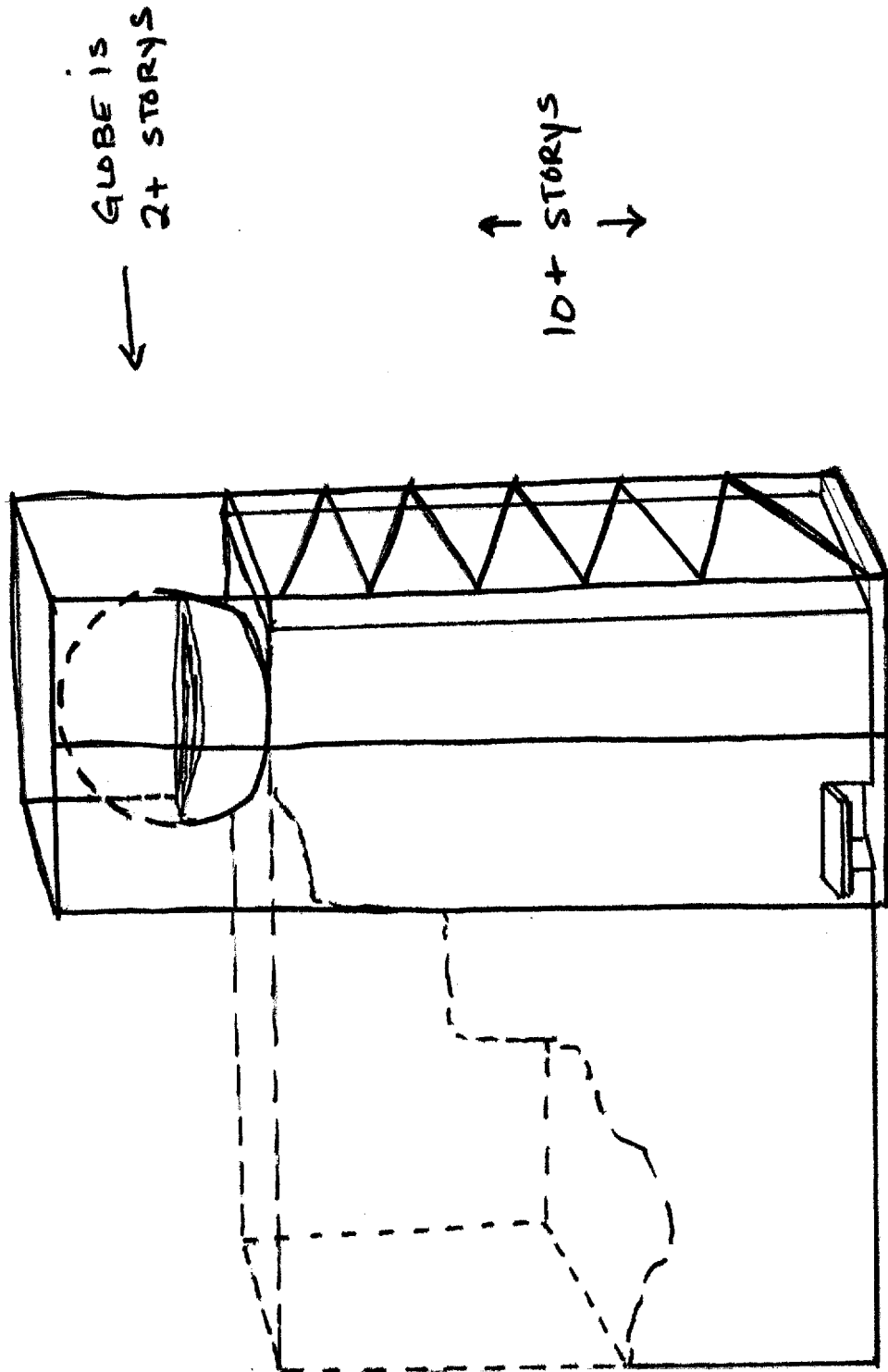

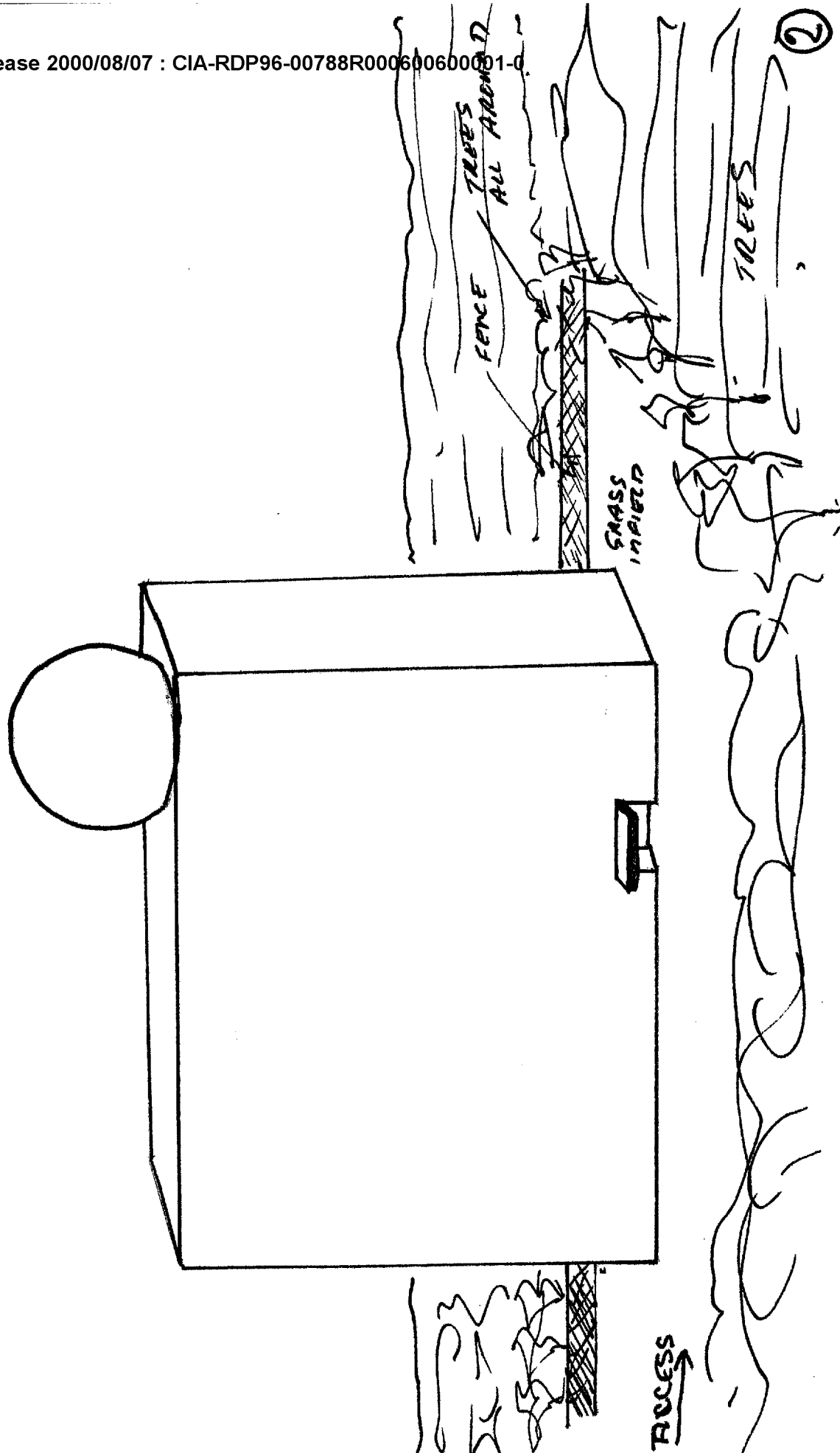

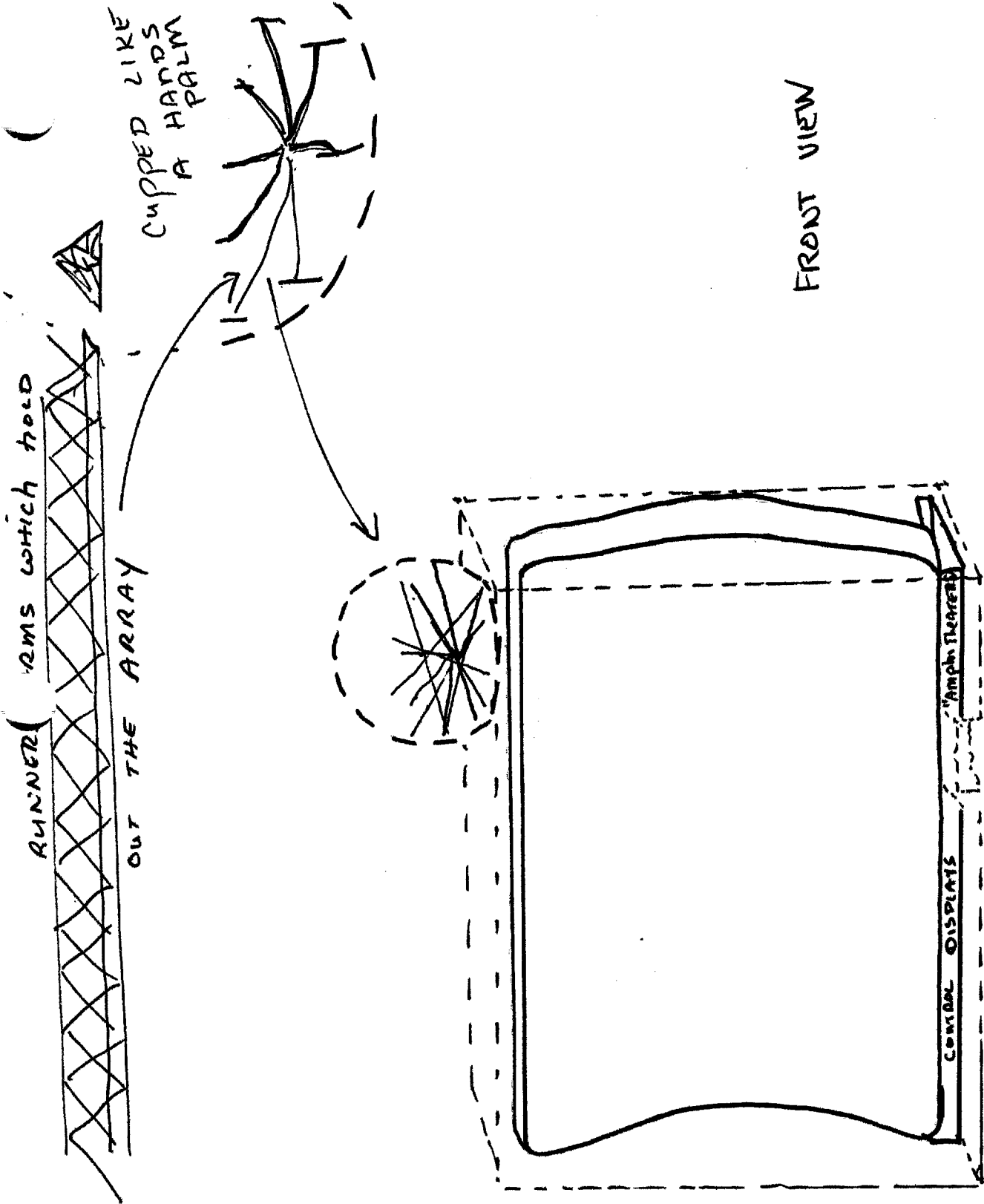

SIDE  
VIEW

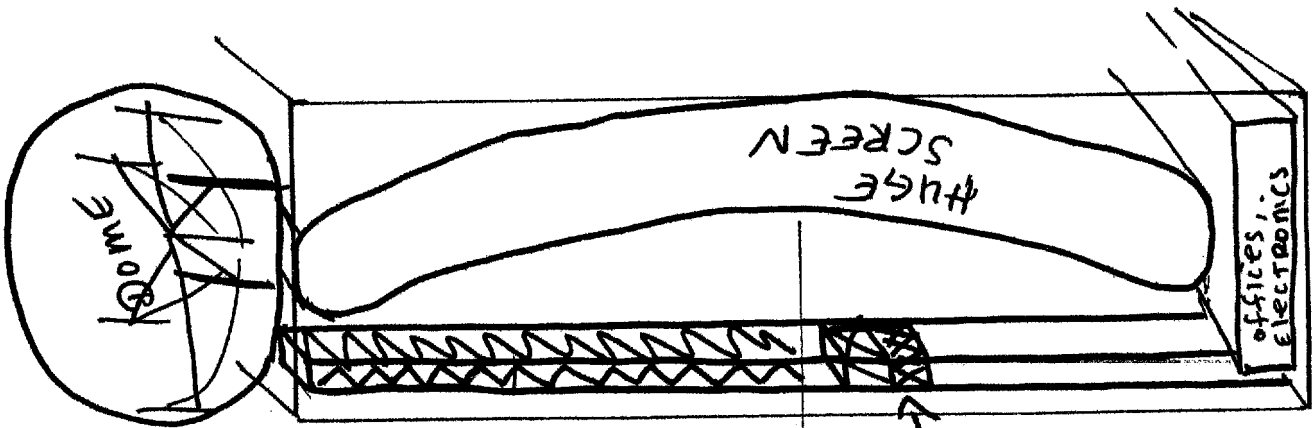

focus point is near the  
 horizon, thousands of  
 miles distant

of 2  
 INTERIORS  
 Elevators  
 which are  
 used by officer  
 watch to inspect  
 the screen



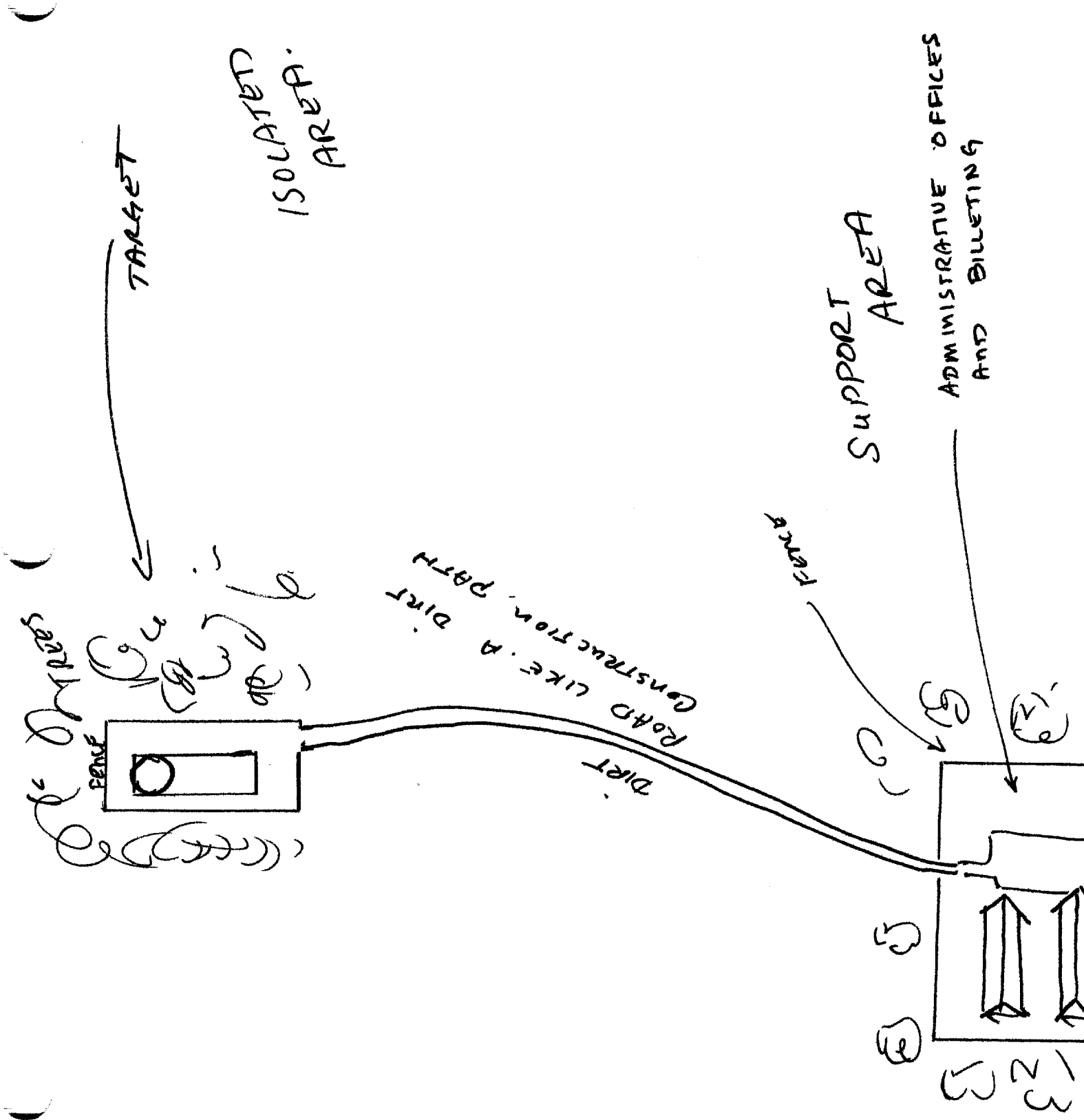

BOTTOM EDGE OF HUGE VERTICAL SCREEN

TV SCREENS OR WITH DISPLAYS OR WITH CRT COLOR

TARGETS INTO THE MOVING FROM SCREEN FROM BELOW HORIZON

PANELING →

LIGHTS →

28 YR OLD  
"STUP IDIOT"  
"HIGH OFFICER"  
WATCH CRIP  
MAYBE CRIP  
OR YOUNG  
MAJOR  
EQUINIA

INFO/DATA DISPLAYED MILITARY LIKE A WAR ROOM  
IN ATMOSPHERE LIKE NORAD HQ WOULD BE.

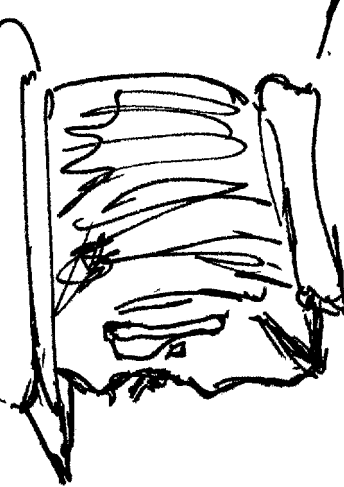

TEACHERS THE SEATS IN LIKE A CIRCLE IN SEMI CIRCLE

SITS ABOVE TECH

THIS GUY NEEDS

TECHNICIAN (BELOW) LIKE IN BOTTOM OF AMPHITHEATER THAT "CALLS UP" THE DATA

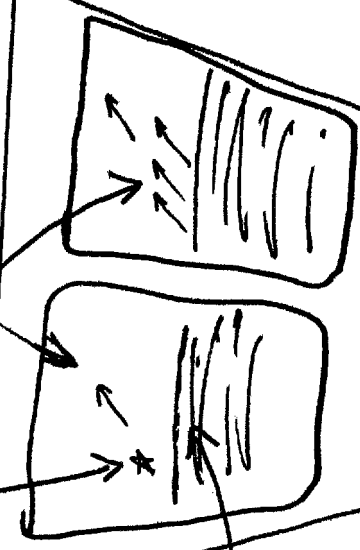

TARGET HORIZON

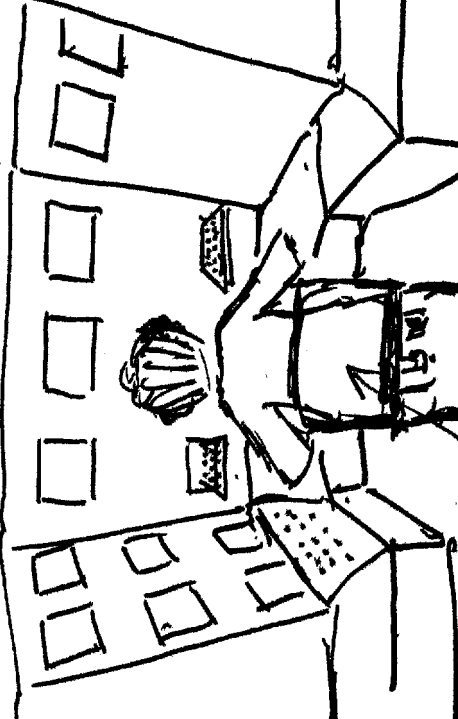

**TAB**

~~SECRET~~

TARGET CUING INFORMATION

REMOTE VIEWING (RV) SESSION DCC-55

1. (S/NOFORN) Prior to the start of this session the remote viewer was given a sealed envelope and was told that it contained the targeting information.
2. (S/NOFORN) During the session the remote viewer was told that in the sealed envelope was a geographic coordinate which identified the location of the target. He was asked to go to the target and describe his surroundings.
3. (S/NOFORN) The target envelope remained sealed throughout the entire session. Neither the remote viewer nor the interviewer knew what the coordinate was.

NOT RELEASABLE TO FOREIGN NATIONALS

~~SECRET~~