

~~SECRET~~

ORCON/NOT RELEASABLE TO FOREIGN NATIONALS

Questionable
Value
Rated
3
out of 3

GRILL FLAME

PROGRAM

SESSION REPORT

CLASSIFIED BY: DIRECTOR, DIA
REVIEW ON: 5 FEB 2000
EXTENDED BY: DIRECTOR, DIA
REASON: 2-301c (3 & 6)

GRILL FLAME

~~SECRET~~

~~SECRET~~

31 Jan 80

SUMMARY ANALYSIS

REMOTE VIEWING (RV) SESSION **CC79**

1. (S) This report documents a Remote Viewing (RV) session conducted in compliance with a request from SOD, J3, OJCS, Pentagon, Washington, D.C. The purpose of the session was to provide information relevant to the hostage situation in the U.S. Embassy compound in Teheran, Iran.
2. (S) The remote viewer's impressions of the target are provided as raw intelligence data and as such have not been subjected to any intermediate analysis, evaluation or collation. Interpretation and use of the information provided is the responsibility of the requestor.
3. (S) The protocol used for this session is detailed in the document, Grill Flame Protocol, AMSAA Applied Remote Viewing Protocol (S), undated.
4. (S) Following is a transcript of the viewer's impressions during the remote viewing session. At TAB A are drawings made by the remote viewer reference his impressions of the target site. At TAB B is target cueing information provided the remote viewer.

~~SECRET~~

TRANSCRIPT

REMOTE VIEWING (RV) SESSION CC 79

*Am B
Rissid*

TIME

#14 This will be a remote viewing session (edited for security).

PAUSE

You have been shown an overhead image of the compound area in Iran. I want you to focus your attention, and concentrate on the building in Area "J." Project yourself to that building and describe the impressions.

PAUSE

+10 #24.5 I'm inside ...fam...familiar...upstairs...hall. I see a down staircase. (Mumbling) the rest of the stairs...looking at them...is open space...

PAUSE

I'm going to try to...explore the short end of the hall.

PAUSE

+13 In the..uh..ender (phonetic) room I have a feeling ..uh..largeness and openness windows around...there is ..uh..something at the left end of the room against the wall and ..uh..I...am having a image of a..uh.. long table with chairs on both sides and the room is ..uh..bigger.

PAUSE

+16 There's something dark and..uh..linear that almost cuts this room in half. It's to the left of the entrance of the door at the end of the hall. It looks like filing cabinets..uh..very..uh..series of things which do not reach to the roof. What I am seeing... it looks like a library card file boxes. Many little pull out tabs on the fronts of many little drawers. I can see over this. These make-up partition...in the room I can see over them into another part of the room which has a depth to it past the door (mumbling) that is.....I am getting a continual feeling of

~~SECRET~~

+18 #24.5 library..uh..like a real library. It's funny there appear to be racks and tables...wall racks like book racks and tables in this section of the room, but no people that I see.

PAUSE

#24.5 Put it on hold and let me go back.

PAUSE

I think, in the hall again, looking the other way, door at the end, I think.

PAUSE

+30 #14 This time I want you to go downstairs to the main meeting room, and describe any activity or personnel in this room.

PAUSE

+35 #24.5 I have a ...feeling of a very large overstuffed chair. (Mumbling) ~~sit~~ (mumbling) with black tapestry with tassels on it. This..uh..sits..uh.. with another on its side. A small table there. I'm looking for people, but...

PAUSE

+38 #24.5 I'm not having any luck today. Can't find any people. Not being (mumbling). Can't see any.

PAUSE

#14 All right. I want you now.....

#24.5 No good #14. I'm not having any luck at all. No. I'm just not...not doing any good. Wish I was but I'm not. I can tell.

#14 All right. We'll put down on paper what you got.

#24.5 That is disappointing too. Dam defenses were up today. For some reason I could not let go of my alert response, you know. Everything that happened, I'd hear it.

#14 It was too quiet. That's the problem.

#24.5 The one time I woke up I got this...when I came out I got this horrendous itch in my eye and my nose. I tried to make it go away and tried and tried. Finally, I just, you know, all it was doing was doing was...it was just like the goddam hook was in my ...in my face and it was just dragging me back up to the surface, you know. I don't know. But, I got in the short end of the hall. I'm pretty solid about that. I don't what is supposed to be down there, but, I ended up with some sort of a funny room. I think it was in that end of the hall. I think I was upstairs. I'm not sure.

#14 Well. Perhaps it could have been upstairs, downstairs.

#24.5 Yeah. Well, anyway we'll put it down there. OK.

Ok. First feeling was this. Right along here. That's a bottom, solid bottom, ok. Here's the down staircase. Down there. This is not the down staircase ramp. The down staircase ramp is there in the background. Like that. That..that goes across, ok. This is what I think was the long end of the hall, and this is where I was. To start with...I tried to...I was dawdling around there. I couldn't get really in good focus. I knew I was there and I felt like I was up floating against the ceiling to start with and looking downward at this thing. What I think I did...well anyway I turned around and I went backwards or to my or to the rear of this picture...that's 2, ok. All right. When I got in there I ended up with a rather large type of a room. There's something.....I wanted to say there's a fireplace along this end. There's something erect, upright, you know and it's against that end, like that. Like that, ok. Up against that thing.

Uh...and here was a..uh..the backs of chairs. Like this. The table like that. That type of a thing. Ok. There. On the...ok...back wall...ok...here.. from the right..this is as though I just come through the door....from the right side....coming into the foreground was this thing that looked like it had a bunch of little drawers in it...like a card file and library. Name-trace file type of a thing. Little 3x5 file, that type thing, ok. I don't know if it was all on solid piece but it was wood...it was a light bro...I mean a..uh..it was a..uh..middle town, wood thing. The other side...something came out like this to make a passageway through there. I don't know

~~CONFIDENTIAL~~

what it was, but, I got the definite feeling that there was something there. Like that. Had the feeling there was another window, over here. Then, when I went around I went through there. I dotted up to here, looked back at the room and then I dotted through there. That's to 3.

When I got into 3 I was just on the other side of this thing so that I felt like, felt as though here was the door, right, the back of those file cabinets...no that goes straight up, yeah...comes over there and there is the door that I came through. I think it's a double door. Uh..and, the feeling I had was that this was...had depth here and went back farther, ok. Along the back of the room, like this, came along this room, like this, all right. I'll put a couple windows there. Uh...here in the foreground left side is the thing that I thought was a bookcase which goes right into the corner of the room, ok. It would be the corner of the room, like that. Or something like that. Then, that, looking over the room from in here...oh, there was something right here with its back to this thing as though there were..uh..as though it was a..uh.. a couple chairs or a sofa with its back to this. I'll draw two chairs, but I saw it when I was coming through. Like that, ok.

Then I had the feeling of a reading room. There was a very dominant reading room, or library or research area feeling in this thing that had..uh..it was hard to explain. It wasn't table upon table upon table working table. It was more like a casual reading room and a library type of a situation, ok. Uh..more like..uh.. more like various size tables, various shape tables, ok. You know. With the chairs pulled up to them like that. I can see the dam place. God, I don't want to put anything in there that is not in there. I had the feeling that this...ok..this feeling.....I'm not going to put in more tables or anything....this feeling of bookcase, floor to ceiling type bookcase, was here where the X is. Somewhere against that wall, ok, and against this wall where that X is. All right. That type of a feeling where the area was surrounded...that's it.

Four, I'll give you what I think is just a regular old floor plan, ok.

Fireplace at that end. Type fireplace thing at that end. Table. Here's the door. Window there. Window there. That bookcase thing. Bookcase here. Window there. Window there. Ok Uh..table or two. Chair there. Chair there. That's the way out of it as I was in a corner. Window here. You can't see that in

~~SECRET~~
4

my other sketch. I guess you can. I'll put it in. There. Window...W for window on 2, ok. Four is that.

Then, when you told me that's...when I faded out of that one, you told me to go to the main conference room type thing...I only...the only thing I got... first thing I got was door. Didn't I tell you...yeah I said a door...got a feeling of this shape of a door with a window in it...a hallway, ok...door at the end of a hall concept. That's five.

Then six. The thing I had a feeling for was..... big overstuffed chair, type of arrangement. Not a bad overstuffed chair, is it. I really surprised my art work today.

#14 Getting better.

#24.5 Yeah.

#14 Practice.

#24.5 That may be it.

#24.5 First thing....let me drop back.....I'll do that for 7...the feeling that this thing sat...this is round table....the insert in 6...it shows, ok...table there...chair ...and then another, another chair sitting like this...like that. A table.....ok.... this type of thing. No people! Could not find any people and I was thinking about people all the time, all the time. I went there....you know....I was sort of free to do my own thing to start....the whole time I kept people right in ...when I got there and I knew that was the job and I just could not find anybody. The other thing that I had....the other feeling that I had....I don't want to associate it with 6 but I had that first.....hum.....ok....old fashioned glass and a martini glass sitting around surface and then I went....that's actually before I had six. But, I.....like I said...I had....when I saw that I had the feeling that they were sitting empty. That they had been there along time....not a long time but that they were there unused. There weren't anybody around drinking out of them. They were just sitting there. You know. Just sitting on top of the table. That's all I got #14.

#14 Ok. We'll call that the end of the session.

TAB

①

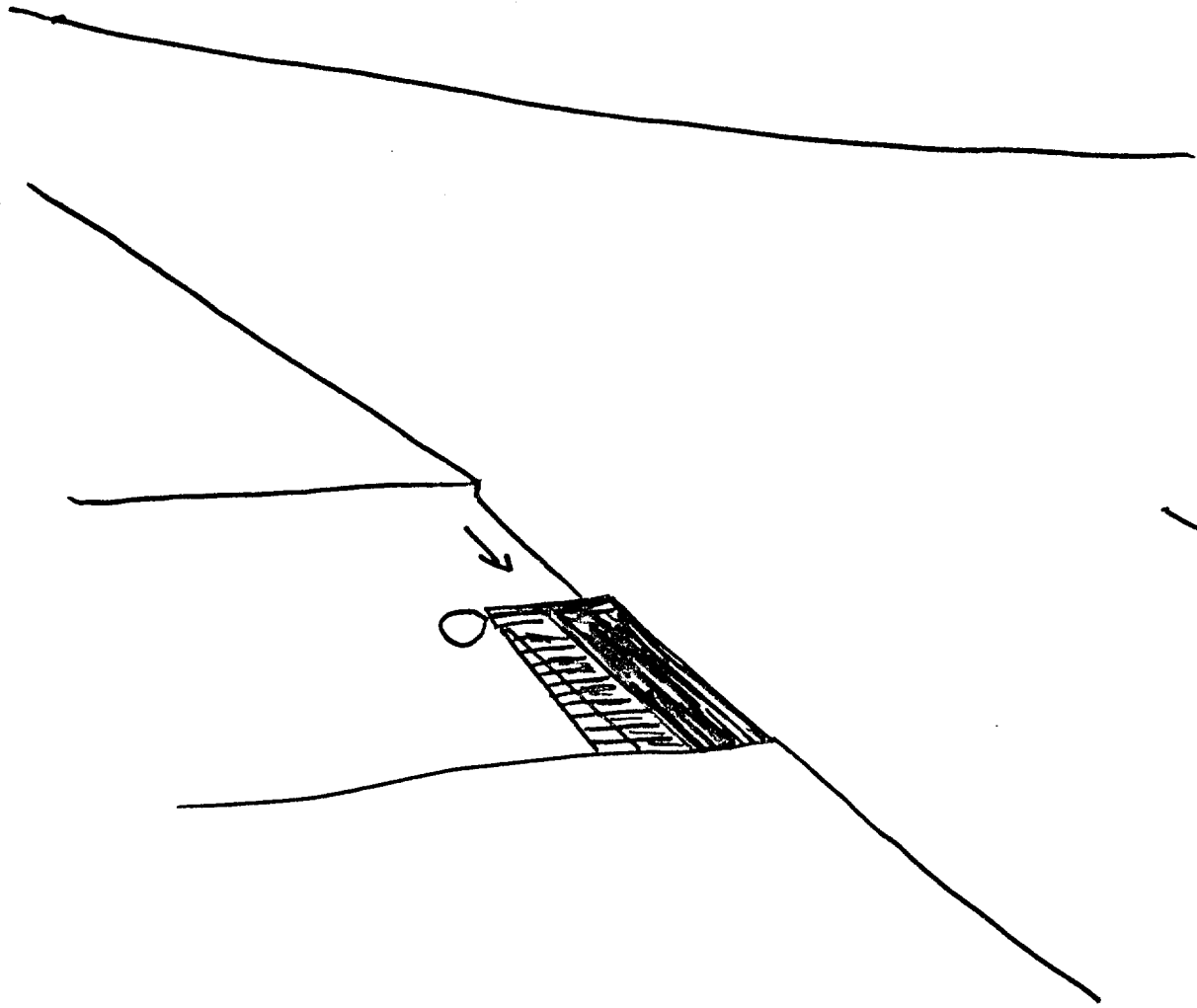

(2)

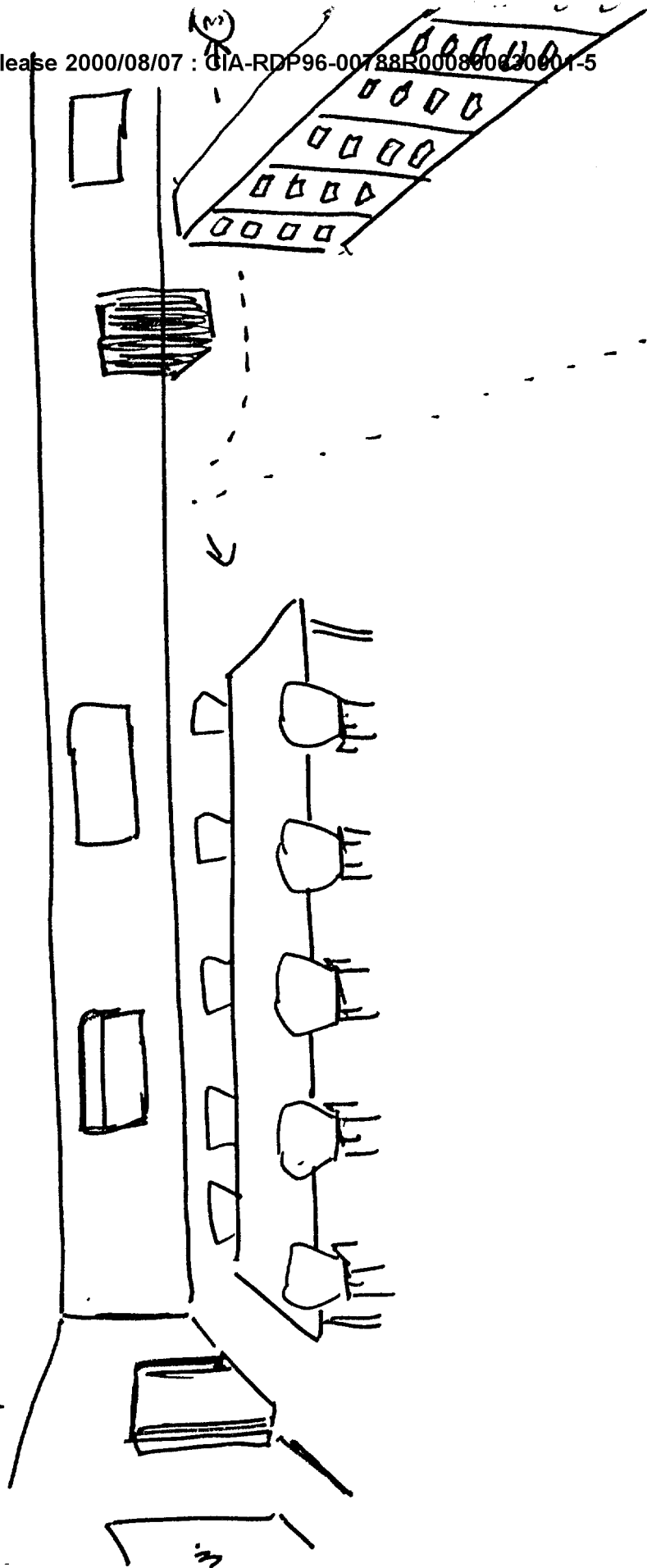

(3)

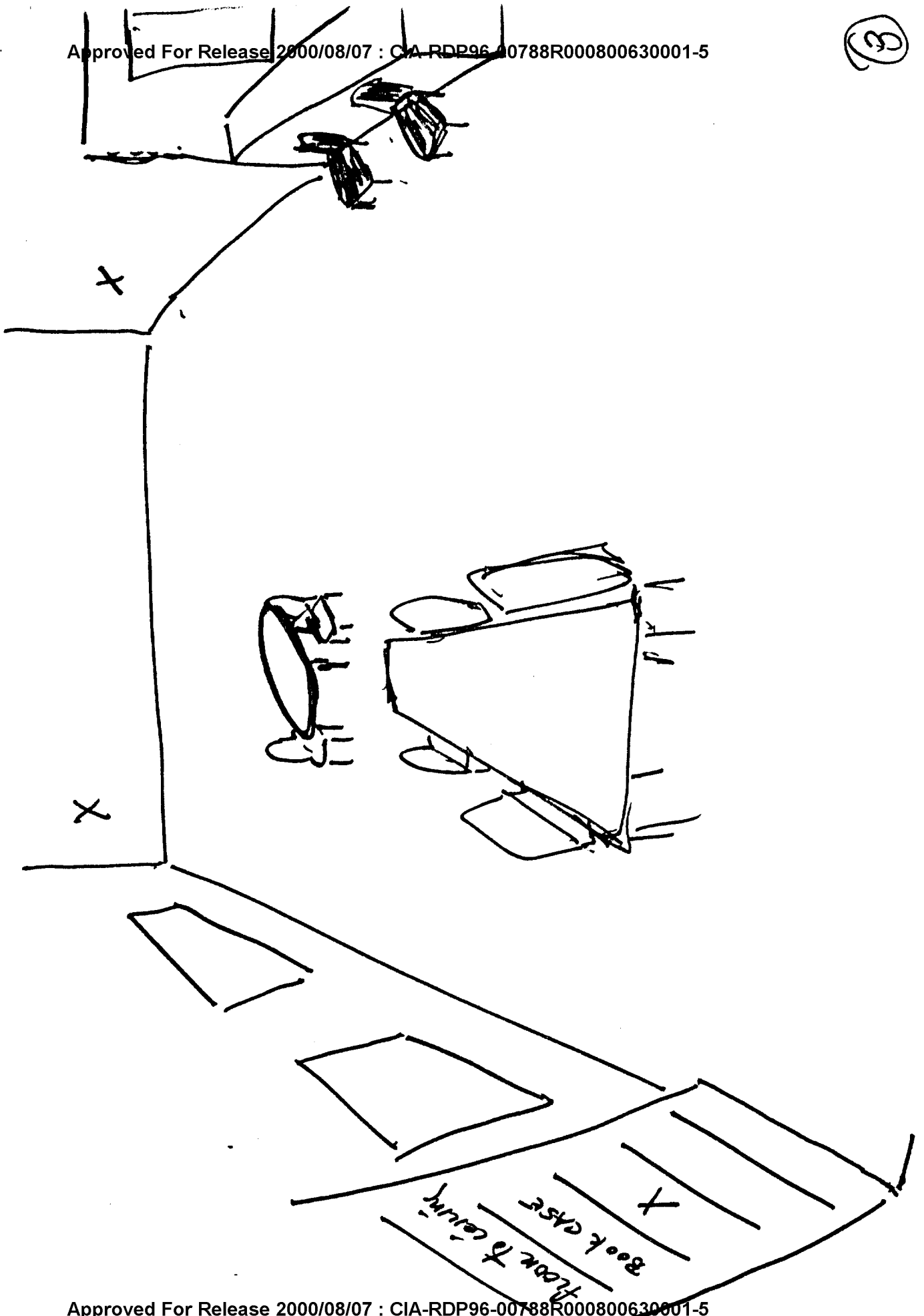

④

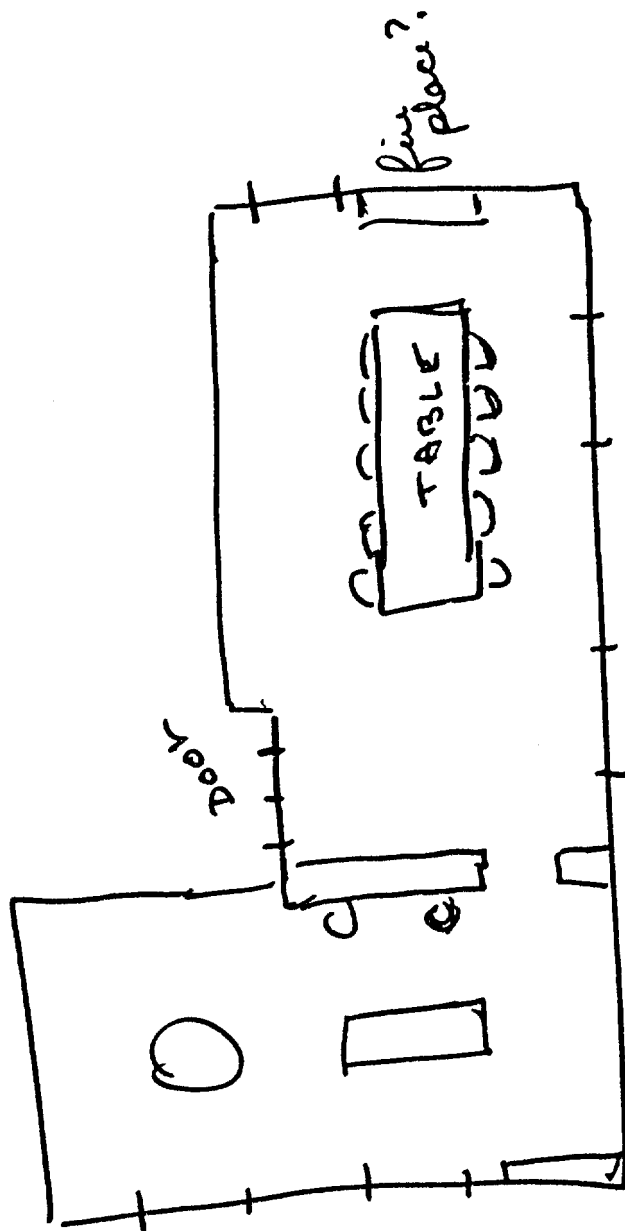

6

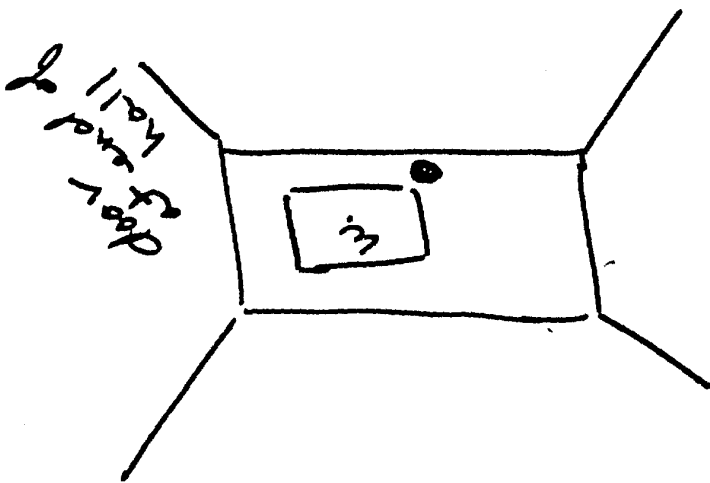

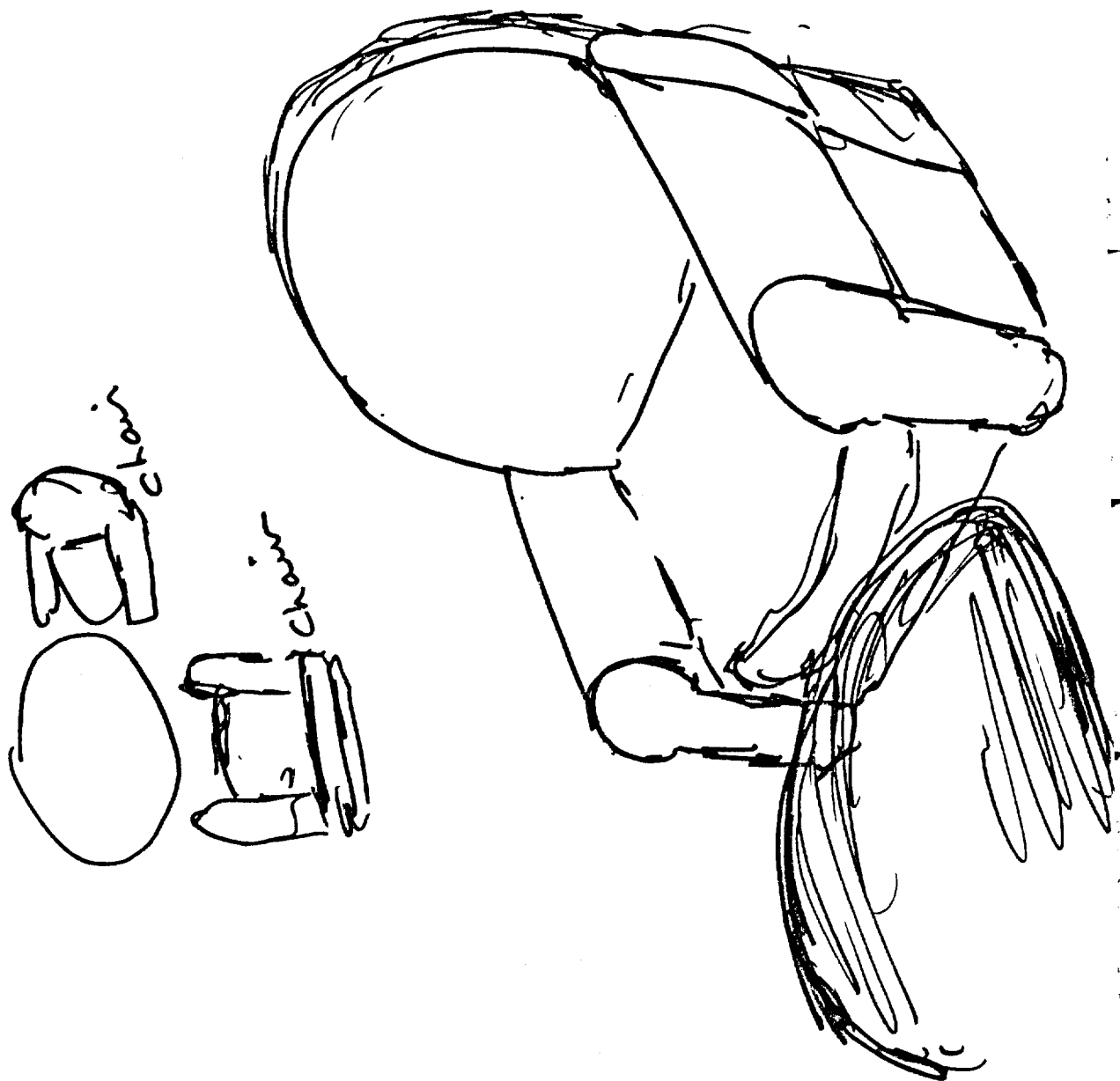

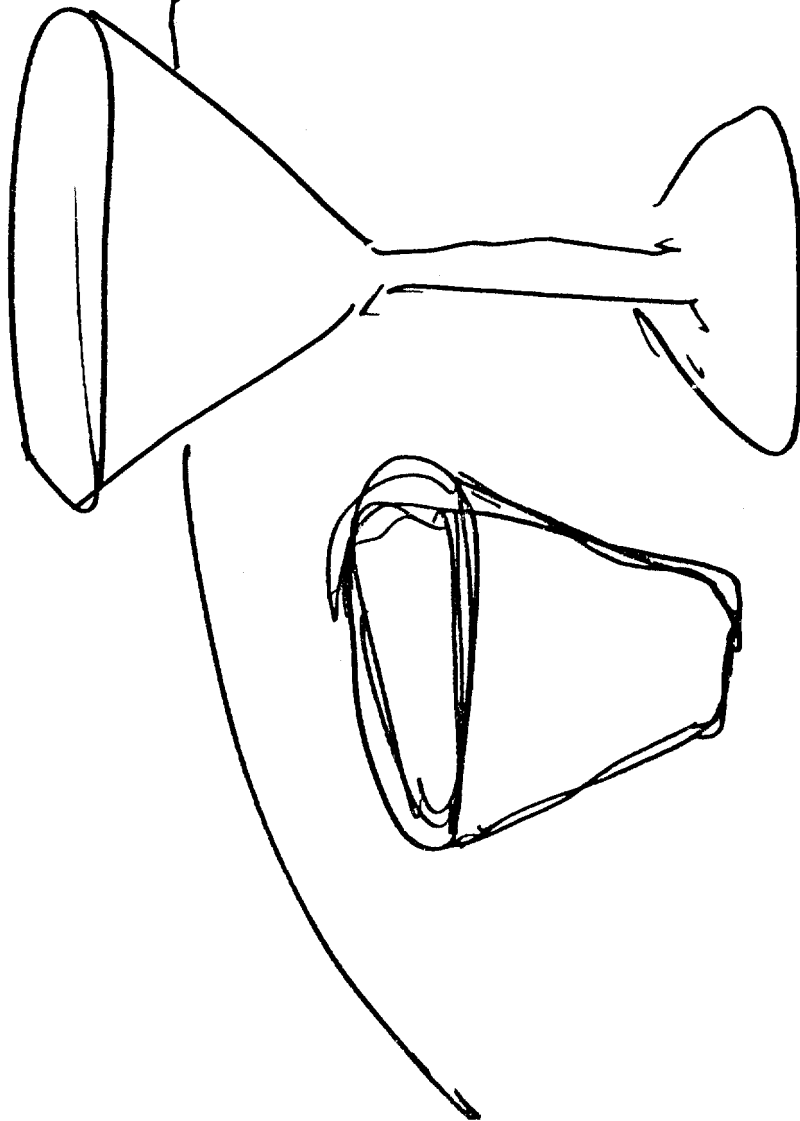

TAB

TARGET CUING INFORMATION

REMOTE VIEWING (RV) SESSION CC79

Amb Resul

1. (S) The viewer has been exposed to open source news media information as well as classified overhead imagery. He knew he would be working against the hostage situation in Iran.
2. (S) At the time of the session, the viewer was asked to describe an area referred to as Area "J." He was shown overhead imagery of the US Embassy compound in Teheran, Iran. The area designated as Area "J" was pointed out to the viewer by the interviewer. The imagery is not included herein due to its classification.
3. (S) The viewer has worked against this target in the past. During this session he was not told anything about the area he was trying to describe except for its letter designation.

~~SECRET~~
~~SECRET~~