

SRI International

~~SECRET~~

Final Report  
Covering the Period 1 May 1979 to 31 March 1980

June 1980

**SPECIAL ORIENTATION TECHNIQUES (U)**

By: RUSSELL TARG HAROLD E. PUTHOFF BEVERLY S. HUMPHREY EDWIN C. MAY

SRI Project 8465

SPECIAL ACCESS PROGRAM FOR  
GRILL FLAME. RESTRICT  
DISSEMINATION TO ONLY  
INDIVIDUALS WITH VERIFIED ACCESS.

Approved by:

ROBERT S. LEONARD, Director  
Radio Physics Laboratory

DAVID D. ELLIOTT, Executive Director  
Systems Research and Analysis Division

Copy No. **26** .....

This document consists of 112 pages

SRI 0-4292

CLASSIFIED BY: Msg, HQDA (DAMI-ISH)  
dated 7 July 1978  
REVIEW ON: 7 July 1998

~~SECRET~~

NOT RELEASABLE TO  
FOREIGN NATIONALS



~~SECRET~~



*Final Report*

June 1980

## SPECIAL ORIENTATION TECHNIQUES (U)

By: RUSSELL TARG HAROLD E. PUTHOFF BEVERLY S. HUMPHREY EDWIN C. MAY

SPECIAL ACCESS PROGRAM FOR  
GRILL FLAME. RESTRICT  
DISSEMINATION TO ONLY  
INDIVIDUALS WITH VERIFIED ACCESS.

333 Ravenswood Avenue  
Menlo Park, California 94025 U.S.A.  
(415) 326-6200

Cable: SRI INTL MNP



~~SECRET~~

NOT RELEASABLE TO  
FOREIGN NATIONALS

~~SECRET~~

CONTENTS (U)

LIST OF ILLUSTRATIONS (U) . . . . . v

LIST OF TABLES (U). . . . . vii

I OBJECTIVE (U). . . . . 1

II INTRODUCTION AND SUMMARY (U) . . . . . 3

    A. Basic Program Structure (U) . . . . . 3

    B. Task Summary (U). . . . . 6

    C. Report Organization (U) . . . . . 8

III BACKGROUND (U) . . . . . 9

    A. Screening (U) . . . . . 9

    B. Remote Viewing Protocols for the Description of Local  
        (San Francisco Bay Area) Target Sites (U) . . . . . 11

        1. Basic Procedural Design (U). . . . . 12

        2. Remote Viewer/Interviewer Roles (U). . . . . 14

        3. Target Pool Selection (U). . . . . 14

        4. Target Storage and Access (U). . . . . 15

        5. Remote Viewer Orientation (U). . . . . 16

        6. Interviewer Behavior (U) . . . . . 17

        7. Target Person ("Beacon") Behavior (U). . . . . 18

        8. Post-Experiment Feedback (U) . . . . . 19

        9. Evaluation Procedure (U) . . . . . 19

IV ORIENTATION PROGRAM--PHASE ONE (U) . . . . . 25

    A. Remote Viewing of Local Target Sites (U). . . . . 25

    B. Summary of the Six Series (U) . . . . . 26

The individual titles on this page are UNCLASSIFIED. However, the compilation of these titles may indicate defense information and material, the unauthorized disclosure of which could reasonably be expected to cause serious damage to the national security; hence, an overall classification of SECRET is warranted.

~~SECRET~~

~~SECRET~~

- 1. Viewer No. 155 (U) . . . . . 26
- 2. Viewer No. 292 (U) . . . . . 29
- 3. Viewer No. 372 (U) . . . . . 34
- 4. Viewer No. 468 (U) . . . . . 36
- 5. Viewer No. 518 (U) . . . . . 39
- 6. Viewer No. 690 (U) . . . . . 41
  
- C. Analysis of Transcript Correlations (U) . . . . . 43
- D. Summary of Judging Results for Local Target Sites (U) . . . . . 47
- E. Phase-One Conclusions (U) . . . . . 50
  
- V ORIENTATION PROGRAM--PHASE TWO (U) . . . . . 57
  - A. Remote Viewing (RV) of 35-mm Slides (U) . . . . . 58
    - 1. Viewer No. 372 RV (U) . . . . . 59
    - 2. Viewer No. 518 RV (U) . . . . . 60
    - 3. Comparison of Blind Judging and Accuracy Ratings for 35-mm Slides (U) . . . . . 67
  - B. Future Remote Viewing (FRV) (U) . . . . . 69
    - 1. Viewer No. 468, RV and FRV of 35-mm Slides (U) . . . . . 70
    - 2. Viewer No. 292, RV and FRV of 35-mm Slides (U) . . . . . 74
    - 3. Viewer No. 155, RV and FRV of 35-mm Slides (U) . . . . . 78
    - 4. Viewer No. 155, FRV of Local Target Sites (U) . . . . . 79
  - C. Extended Remote Viewing (ERV), Viewer No. 518 (U) . . . . . 83
    - 1. Background (U) . . . . . 83
    - 2. Pilot Effort (U) . . . . . 83
    - 3. Formal Series (Six Trials) (U) . . . . . 83
    - 4. Discussion (U) . . . . . 92
  - D. Remote Viewing of Alphabet Letters (U) . . . . . 93
  - E. Coordinate Remote Viewing (CRV) with Immediate Feedback (U) . . . . . 94
  
- VI CONCLUSIONS AND RECOMMENDATIONS (U) . . . . . 99

~~SECRET~~

~~SECRET~~

ILLUSTRATIONS (U)

1	Stanford Art Museum Target (a), and Response (b), by Viewer 372 (U) . . . . .	5
2	Beacon Tower in Vicinity of Control Tower Target at Palo Alto Airport (a), and Response by Viewer No. 292 (b) (U) . .	33
3	Windmill Target and Responses by Viewers S5 (a) and No. 468 (b) (U). . . . .	45
4	Redwood City Cross Target, and Responses of Viewers 372 (a) and 155 (b) (U). . . . .	46
5	Pedestrian Overpass Target, and Responses of S4 (a) and No. 155 (b) (U). . . . .	48
6	Distribution of 36 Target/Transcript Correspondences for Local Target Sites (6 subjects, 6 transcripts each), Showing More than 50% First-Place Matches (U). . . . .	49
7	Comparison Between Blind-Judge Rankings and Accuracy Assessments (U). . . . .	51
8	Ultra Modern Dome House--Target, and Viewer 372 Drawing (U). . . . .	61
9	Mount Alverno Conference Center, and Viewer 372 Drawing (U). . . . .	62
10	Stanford Shopping Center--Target, and Viewer 372 Drawing (U). . . . .	63
11	Varsity Theatre Arcade--Target, and Viewer 518 Drawing (U). . . . .	64
12	Victorian House--Target, and Viewer 518 Drawing (U). . . . .	65
13	Glass Slipper Motel--Target, and Viewer 518 Drawing (U). . .	66
14	Stanford Shopping Center--Target, and Response of Viewer No. 468 (U) . . . . .	72
15	Target Slide, and Viewer 292 Response Fifteen Minutes Before Random Selection of Target (U) . . . . .	76
16	Target Slide, and Viewer 272 Response Fifteen Minutes Before Random Selection of Target (U) . . . . .	77

~~SECRET~~

~~SECRET~~

17	Copper Pitcher and Viewer No. 518 ERV Response (U) . . . . .	85
18	Food Mill Target and Viewer No. 518 ERV Response (U) . . . . .	86
19	Straw Hat Target and Viewer No. 518 ERV Response (U) . . . . .	88
20	Tripod Target and Viewer No. 518 ERV Response (U). . . . .	89
21	Antenna and Viewer No. 518 ERV Response (U). . . . .	90
22	Globe Target and Viewer No. 518 ERV Response (U) . . . . .	91

~~SECRET~~

~~SECRET~~

TABLES (U)

1	Results of Transcript Concept Analysis of a Remote Viewing Experiment (U) . . . . .	22
2	0-7 Point Accuracy Rating Scale for Target/Transcript Correspondence (U) . . . . .	27
3	Total Scores for Each of the Six Viewers in Phase-One Orientation Program (U). . . . .	52
4	Distribution of CRV Target/Response Matchings (U). . . . .	98
5	Program Summary (U). . . . .	100

~~SECRET~~

~~SECRET~~

I OBJECTIVE (U)

(S) The objectives of this program are the optimization of remote viewing (RV) protocols, the orientation of selected individuals to reach enhanced levels of ability, and the establishment of screening procedures to enlarge the population from which individuals are selected.

~~SECRET~~



~~SECRET~~

## II INTRODUCTION AND SUMMARY (U)

### A. Basic Program Structure (U)

(S) In this report we present results and assessments of a one-year program for the optimization of remote viewing with client-selected individuals. The objective of this program was to familiarize these individuals with the SRI remote viewing protocols, to produce enhanced levels of ability, and to establish screening tests and procedures for enlarging the population from which such individuals are selected.

(U) For the past seven years SRI International has been investigating a human perceptual/processing ability called remote viewing (RV). This is the subject matter of the current study, and it pertains to the acquisition and description, by mental means, of information blocked from ordinary perception by distance or shielding and generally considered to be secure from such access.

(S) At the start of this program, six individuals were chosen by the client organization to participate in an RV technology transfer. With the exception of one of the six who had participated in an ESP study several years earlier, these participants when selected were inexperienced with regard to paranormal perception in general, and RV in particular. A variety of different training protocols were examined with the goal of helping the participants familiarize themselves with the SRI RV techniques. Formal assessment and transfer series were carried out with each of the six participants, in which they were asked to use mental imagery processes to describe distant geographic locations (bridges, roads, buildings, etc.), hidden 35-mm slides of similar sites, and objects placed in a controlled-access location. Several other information series were carried out. These are all described in later sections of this report.

~~SECRET~~

~~SECRET~~

(U) Four of the six participants each produced results that departed significantly from chance expectation in assessment series that were formally judged by very strict criteria. The other two produced results in the assessment series that were also suggestive of paranormal perception. Overall, this result constitutes highly significant performance ( $p = 4 \times 10^{-5}$ , or odds of one in 25,000 of such a result occurring by chance).

(S) We are including in this introduction one illustrative example of an RV trial for a real-time San Francisco Bay Area outdoor target. The viewer, No. 372, who contributed this data, produced a mixture of responses, some excellent and some noncorresponding, in his two series at SRI. Several of his descriptions were among the best obtained in the program, and his overall consistency in performance resulted in both of his individual series reaching statistical significance.

(U) Current and proposed programs are directed at training participants to bring their RV ability under more conscious control, and to learn to recognize and overcome the factors that limit RV reliability. These limiting factors center around the generation of erroneous data by the viewer from his memory and imagination. An example of the successful resolution of such noise is the following.

(U) The viewer was closeted with an interviewer in the laboratory at SRI to await the target team's arrival at their destination. The target was the Stanford Art Museum on the Stanford campus. The viewer made several tentative outline sketches of different shapes that he said were "associated with the face of a building." Finally, he made a careful perspective drawing of the building he was visualizing. A photograph of the target is shown in Figure 1(a), and the viewer's drawing is shown for comparison in Figure 1(b). The viewer's narrative described the face of the building as follows: "There is a white and black pattern, a white

~~SECRET~~

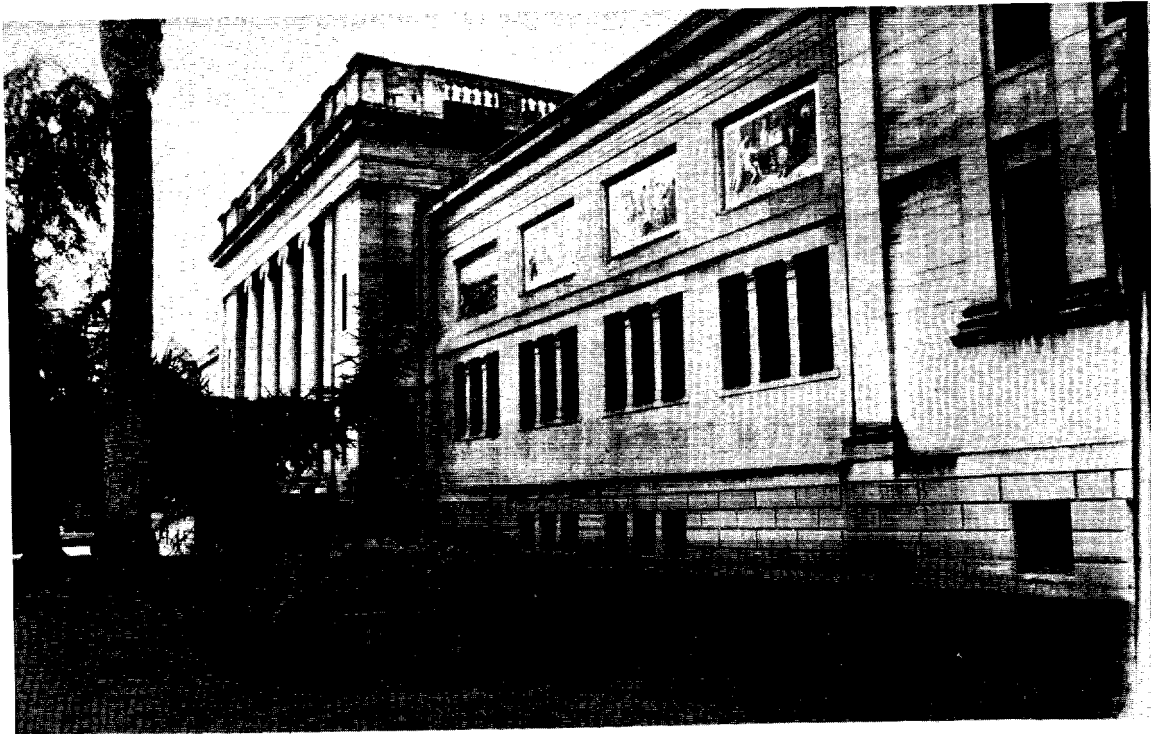

(a)

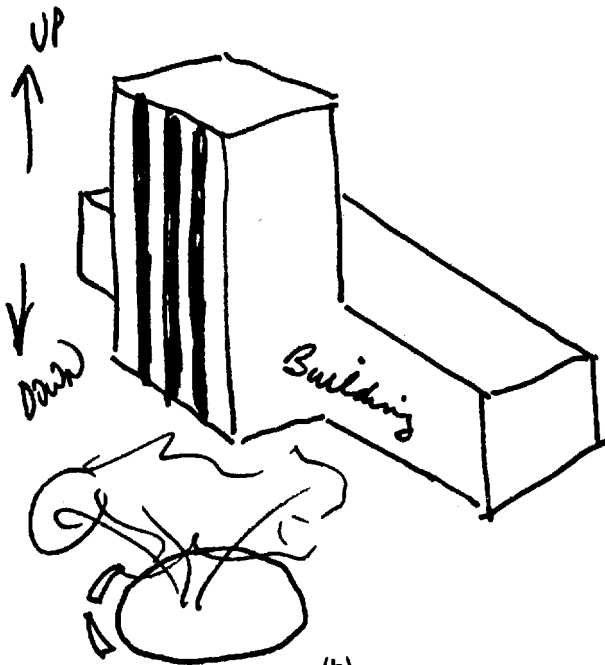

(b)

**UNCLASSIFIED**

FIGURE 1 STANFORD ART MUSEUM TARGET (a), AND RESPONSE (b), BY VIEWER 372 (U)

~~SECRET~~

(U)

and black striped pattern." ... "It's like an inverted rectangle, with a square fastened to the back, or a rectangle laid down behind it." "Like two buildings in one. One building." "I have the sense that there is dirt by the walls ...." He went on to talk about trees, flowers, and bicycles, all of which can be found directly in front of the target building.

B. Task Summary (U)

(U) In the following we briefly summarize results of the various perceptual tasks that were undertaken:

- (U) Bay Area Target Site Remote Viewing. In the Phase One activities, six RV trials with local San Francisco Bay Area sites as targets were carried out with each of the six viewers. In these six series, four of the viewers each produced results that were independently significant ( $p < 0.05$ ), making the series as a whole strongly significant ( $p = 4 \times 10^{-5}$ ; odds of one in 25,000).
- (U) Remote Viewing of 35-mm Slides. These trials were carried out under varying conditions for five viewers in Phase Two. One viewer, who generated significant results in Phase One, was again independently significant in his description of distant slides. A second viewer, also producing significant results in Phase One, produced drawings in Phase Two that were formally judged to have significant correlations with the slide targets, although his verbal material did not. A third viewer was asked to describe slides before they were chosen, that would be shown to him at a later time. His results were suggestive of success ( $p = 0.1$ ) but not statistically significant. Similar trials with two other viewers were also encouraging but nonsignificant.
- (S) Remote Viewing into a Secure Area. A viewer who was successful in the slide viewing trials also carried out a series using extended remote viewing, in which he spent more than an hour on each of six attempts to describe objects held in a secure location, and chosen by the SSO

~~SECRET~~

~~SECRET~~

(S)

controlling that facility. Two judges evaluated this viewer's responses: one judged it significant ( $p = 0.05$ ), and one just missed significance.

- (U) Alphabet Targets. A viewer successful in both Bay Area remote viewing and slide trials also participated in a series in which he attempted to describe alphabet letters in a distant location. This was not a formal series, since the protocol, which was exploratory in nature, was changed several times during the series. However, the percentage hits result indicates that the viewer was in contact with the target letters at a rate higher than would be expected by chance. These data, taken in conjunction with data generated on another program, show promise that this ability can be developed.
- (U) Correlated Responses. In the course of the year's work, targets were repeated from time to time as a result of random selection from a target pool of sixty. In some cases we obtained strikingly similar responses (even when incorrect) from the different viewers who encountered these repeated targets. These responses also correlated well with responses obtained from other viewers over past years of research. The observation of such a result indicates the possibility that given target stimuli trigger characteristic responses, which could be tabulated in a "dictionary" of site attributes.
- (S) Coordinate Remote Viewing (CRV). Three of the viewers took part in CRV exercises in which they were asked to describe distant locations anywhere on the globe, given only the geographical coordinates of latitude and longitude. This is an ability that has been well demonstrated by some of our experienced participants, and similar encouraging results were obtained in these trials with client personnel. One exercise which was sufficiently lengthy to justify analysis was found to be statistically significant at  $p = 0.0083$  (odds of one in 120).

(S) From these studies we find evidence that the SRI RV technology is transferable; one of the client viewers turned in clearly superior performances, and three others produced successful (statistically significant) remote viewing at a level to indicate useful information transfer.

~~SECRET~~

~~SECRET~~

C. Report Organization (U)

(U) In Section III we describe the SRI RV protocols, including results from the past, and our expectations for the present program. We also discuss the screening procedures used to select viewers and the judging procedures used to evaluate the results of the investigations carried out in the current program.

(U) In Section IV we describe the first phase of the study, in which we systematically carried out RV trials with the participants to obtain baseline data from each under similar experimental conditions.

(S) In Section V we present the exploratory work carried out in Phase Two in an effort to extend the repertoire of RV tools available to client personnel.

(U) Our conclusions and recommendations are presented in Section VI.

~~SECRET~~

~~SECRET~~

### III BACKGROUND (U)

(U) With the overall objective of improving the reliability of psychoenergetic functioning, we have in the past investigated several different screening procedures, familiarization/training protocols, and judging techniques, both with the goal of developing procedures useful in identifying gifted remote viewers, and of providing the most optimal strategies to permit individuals to exploit the RV phenomenon to useful ends. In this section we provide background data on each of these areas.

#### A. Screening (U)

(S) One of the goals of the program was to pursue the question of the establishment of screening procedures to enlarge the population from which individuals are selected for RV work.

(U) In the psychoenergetics field in general, two approaches to screening have been pursued; screening by profile, and screening by performance. Both have been examined to a limited degree in this program.

(U) In screening by profile, one attempts to establish physiological and/or psychological parameters which differentiate high-performance from low-performance individuals. In an early program SRI carried out an extensive profiling program on gifted individuals and controls. The tests included a comprehensive medical evaluation, including X-ray scans of the brain, and comprehensive psychological and neuropsychological profiling. The following list of tests administered gives an idea as to the thoroughness of the evaluations: Wechsler Adult Intelligence Scale (WAIS), Bender Gestalt Visual Motor Test, Benton Visual Memory Test, Wechsler Memory Scale, Luscher Color Test, Strong Vocational Interest Blank, Minnesota

~~SECRET~~

~~SECRET~~

(U)

Multiphasic Personality Inventory (MMPI), Edwards Personality Preference Schedule (EPPS), Rorschach Inkblot, Thematic Apperception Test (TAT), Halstead Category Test, Tactual Performance Test, Speech Perception Test, Seashore Rhythm Test, Finger Tapping Test, Trail Making Test, Knox Cube Test, Raven Progressive Matrices, Verbal Concept Attainment Test, Buschke Memory Test, Grooved Pegboard Tests, Gottschaldt Hidden-Figures Test, and the spatial relations subtest of the SRA Primary Mental Abilities Test. The overall result of this testing was that no clear profile parameters emerged on which an a priori screening procedure could be based.\*

(S) In contrast to formal testing, however, several years observation of remote viewers by SRI researchers has led to an informal guide based on subjective evaluation of the personality traits of successful viewers. This rule-of-thumb guide is based on the observation that successful remote viewers tend to be confident, outgoing, adventurous, broadly successful individuals with some artistic bent. With this as a guide, the sponsor considered a population of 250 potential candidates for the RV program. Of these, 117 were interviewed, resulting in a pool of 30-35 individuals for potential active use in the program. With regard to the SRI orientation program, ten of these were selected for interview by the SRI team, of which six were chosen for active participation in the SRI program. This constitutes the level of screening by profile.

(U) In screening by performance, a number of unselected or pre-selected individuals are given a psychoenergetics task to perform. Those performing successfully are then said to be screened by the task, and are then graduated to further tasking.

---

\* (U) H. Puthoff and R. Targ, "Perceptual Augmentation Techniques (U)," Final Report, SRI Project 3183, SRI International, Menlo Park, CA (December 1, 1975), SECRET.

~~SECRET~~



~~SECRET~~

(S) In this study, the six individuals pre-screened by interview were then screened by performance on a six-trial RV series involving local San Francisco Bay Area locations as target sites. Four of the six participants produced results that individually were statistically significant. Since this overall result is itself statistically significant we take as evidence that the interview selection (screening) procedure based on the SRI-supplied informal guidelines was successful, keeping in mind that the sample is too small to make an absolutely definitive statement.

(S) Furthermore, taking the initial six-trial series as a performance-screening instrument, we found that the four high-performance individuals in this series continued to perform with good success in additional tasks, while the two lower-performance individuals were also less successful in later tasks. We consider this to be an important finding.

(U) From these overall results we conclude that pre-screening on the basis of interview, following the informal SRI guideline criteria, and screening by performance, using the SRI Standard RV Protocols, both constitute basic screening tools that in this program provided reliable indicators of success in psychoenergetic performance.

B. Remote Viewing Protocols for the Description of Local (San Francisco Bay Area) Target Sites (U)

(U) As a result of efforts over the years to develop an optimum psychoenergetic task appropriate for screening and training, we have settled on a standard remote-viewing (RV) procedure which is a refined version of that described in our Proc. IEEE paper.\* The elements of the

---

\* (U) H. E. Puthoff and R. Targ, "A Perceptual Channel for Information Transfer over Kilometer Distances: Historical Perspective and Recent Research," Proc. IEEE, Vol. 64, pp. 329-354 (March 1976).

~~SECRET~~

**UNCLASSIFIED**

(U)

protocol, each of which is addressed below, consist of (1) basic procedural design; (2) remote viewer/interviewer roles; (3) target pool selection; (4) target storage and access; (5) remote viewer orientation; (6) interviewer behavior; (7) target person behavior; (8) post-experiment feedback; (9) evaluation procedure.

1. Basic Procedural Design (U)

(U) As carried out at SRI, the general procedure is to closet the percipient, hereafter called the viewer, with an interviewer, and at a prearranged time to obtain from the viewer a description of an undisclosed, remote site being visited by a target team, one of whose members is known to the remote viewer and who thereby constitutes the target or "beacon" person.\* The target team is assigned their target location by random entry into a list of targets located within a 30-minute driving time from SRI. The target pool consists of sixty target locations chosen from a target-rich environment. The target location selected is kept blind to both the viewer and interviewer closeted at SRI. The protocol is thus of the double-blind type.

(U) In detail: At the beginning of a trial, a remote viewer is closeted with an interviewer in an isolated windowless room of the Radio Physics Laboratory in the SRI complex to await an agreed-upon start time. At the same time a target person is sent, without communication with the remote viewer or interviewer remaining at SRI, to a target location somewhere in the San Francisco Bay Area (~500 square km). The target is

---

\* (U) The target person is designated a "beacon" rather than a "sender" because the evidence to date points to the remote viewer exhibiting an independence of viewpoint and mobility at the target site which takes the phenomenon beyond simply mind-to-mind information transfer.

**UNCLASSIFIED**

UNCLASSIFIED

(U)

determined by random-number access to a target pool of travelling orders previously prepared by an experimental team (not including interviewers) and kept locked in a secure safe. The target pool consists of 60 target locations chosen from a target-rich environment.

(U) During a predetermined viewing period of 15 minutes duration, the remote viewer is asked to render drawings and describe into a tape recorder his impressions of the target site being visited by the outbound target person. The interviewer with the remote viewer is kept ignorant of the target and is therefore free to question him to clarify his descriptions without fear of cueing (overt or subliminal) as to the particular target.

(U) When the target person returns to SRI following the remote viewing period, the subject is then taken to the target site so that he may obtain direct feedback. Following a series of such trials over a several-day period, a formal blind judging procedure (described below) is used to evaluate the data and quantify the results.

---

\* (U) There is, however, a confounding factor that needs to be taken into account. Since general knowledge of the San Francisco Bay Area target region on the part of the remote viewer and interviewer must be taken as a given, and since particular knowledge of the contents of the target pool is revealed as a series progresses, in evaluating the results one must take into account the possibility that any particular description may be artifactually sharpened. (Such sharpening can in principle increase the apparent quality of the result only if there is functional RV to begin with; it cannot in the absence of RV produce an inflated result.) This sharpening possibility in the presence of an already functioning RV capability is handled in the statistical evaluation of the results by conservatively assuming the worst at the outset, and treating the series as belonging to that class of studies in which the elements of the target pool are known a priori to both remote viewer and interviewer, as in studies involving numbers or cards as targets.

UNCLASSIFIED

~~SECRET~~

## 2. Remote Viewer/Interviewer Roles (U)

(U) An important methodological aspect of the SRI RV protocols is based on the fact that the remote viewer/interviewer team constitutes a single information gathering unit in which the remote viewer's role is designed to be that of perceiver/information source, and the interviewer's role is designed to be that of analytical control.

(S) This division of labor is designed to mirror the two primary modes of cerebral functioning; namely, the nonanalytic cognitive style (related to brain function) that predominates in spatial pattern recognition and other holistic processing (and is hypothesized to predominate in psi functioning), and the analytical cognitive style that predominates in verbal and other analytical functioning.\* (Only very experienced remote viewers appear to have the ability to handle both cognitive styles simultaneously.) The interviewer role, removing as it does the burden of analytical functioning during exercise of the RV faculty, appears to be a key element in generating the level of success required in operational programs, and we attribute the success of the SRI RV protocols in large part to this innovative design which appears to provide an appropriate match to the required functioning.

## 3. Target Pool Selection (U)

(U) Target locations in the San Francisco Bay Area are selected by a team of two Radio Physics Laboratory personnel who are not involved

---

\* (U) See, e.g., J. Ehrenwald, "Cerebral Localization and the Psi Syndrome," J. of Nervous and Mental Disease, Vol. 161, No. 6, pp. 393-398; R. Ornstein, The Nature of Human Consciousness, San Francisco, CA: Freeman, 1973, Ch. 7 and 8; and R. W. Sperry, "Cerebral Organization and Behavior," Science, Vol. 133, pp. 1749-1757 (1961).

~~SECRET~~

~~UNCLASSIFIED~~

(U)

as interviewers in the experiments (to prevent direct knowledge of the target pool by the interviewers). The locations are chosen to satisfy the following criteria:

- (1) Target sites must be within a half-hour drive of the SRI Menlo Park complex so that a uniform target access time exists for all experiments.
- (2) The target pool is constructed to contain several targets of various types--that is, several fountains, several churches, several boathouses, and so forth--specifically to circumvent analysis strategies of the type "there was a fountain yesterday, so it is unlikely that there is a fountain today." Furthermore, targets of different types are not chosen to be particularly distinct from each other, so that overlapping features exist. In this manner the content of a given target, determined by random entry into the target pool, is essentially independent of the contents of other targets ("open-deck" design).
- (3) The definition of what constitutes each target is established in advance of the entire RV series by written descriptions on a set of 3" X 5" target cards. (Ex: Four Seasons Restaurant, on El Camino Real, just north of San Antonio Road. Stand under the entry arch and feel the bricks.) These cards constitute the outbound team's instructions at the beginning of the trial, and the judge's target list during the evaluation phase.

4. Target Storage and Access (U)

(U) The target cards are numbered and placed in individual envelopes, similarly numbered, by the target selection team, and then stored in a GSA-approved secure container not available to project remote viewers.

(U) At the start of an RV session the interviewer, remote viewer, and target person rendezvous in the laboratory and establish the trial start time (30 minutes hence). The target person then leaves the

~~UNCLASSIFIED~~

~~UNCLASSIFIED~~

(U)

laboratory, generates a random number by the use of the random-number function on a Texas Instruments Model SR-51 hand calculator (whose randomness has been verified by a separate test), obtains the associated envelope from the safe, and departs for the target site.

5. Remote Viewer Orientation (U)

(U) During the period that the target person is enroute to the target, the interviewer and remote viewer have a period to relax and discuss the protocols. The goal of the interviewer during this period is to make it "safe" for the remote viewer to experience remote viewing. For the initial orientation of a new remote viewer, this typically includes a discussion as to how remote viewing appears to be a natural rather than abnormal function, and that many people appear to have done it successfully.

(U) The remote viewer is told that memory and imagination constitute noise in the channel, and therefore the closer he can get to raw uninterpreted imagery, the better. He is encouraged to report raw perception rather than analysis, since the former tends to be correct while the latter is often wrong.

(U) Since remote viewing is a difficult task, apparently similar to the perception of subliminal stimuli,\* it takes the full attentive powers of the remote viewer. Therefore, the environment, procedures, etc., are designed to be as natural and comfortable as possible so as to minimize the diversion of attention to anything other than the task at hand. No hypnosis, strobe lights, or sensory-deprivation procedures are used, since

---

\* H. F. Dixon, "Subliminal Perception and Parapsychology: Points of Contact," Proc. of the XXVII Annual International Conference of the Parapsychology Foundation, Inc., New York (1979).

~~UNCLASSIFIED~~

~~SECRET~~

(U)

in our view such (novel) environmental factors would divert some of the subject's much-needed attention.

6. Interviewer Behavior (U)\*

(U) The interviewer arranges ahead of time to have pen and paper available for drawing, and a tape recorder. The room lighting is somewhat subdued to prevent after-image highlights, shadows on eyelids, etc.

(U) When the agreed-upon RV trial time arrives, the interviewer simply asks the remote viewer to "describe the impressions that come to mind with regard to where the target person is." The interviewer does not pressure the remote viewer to verbalize continuously; if he were to, the remote viewer might tend to embroider descriptions to please the interviewer, a well-known syndrome in behavioral studies of this type. If the remote viewer tends toward being analytical ("I see Macy's") the interviewer gently leads him into description, not analysis. ("You don't have to tell me where it is, just describe what you see.") This is the most important and difficult task of the interviewer, but is apparently necessary for good results, especially with inexperienced remote viewers.

(U) It is also useful for the interviewer to "surprise" the remote viewer with new viewpoints. ("Go above the scene and look down-- what do you see? If you look to the left, what do you see?") The remote viewer's viewpoint appears to shift rapidly with a question like this, and the data come through before the viewer's defenses activate to block it out.

---

\* (S) The interviewer role described here, applicable to the familiarization/screening task at hand, is appropriately modified for an operational task involving an experienced remote viewer. In the SRI operational procedure the interviewer is typically more "muzzled" in general, although, if not blind to the target, supplying positive feedback at certain key points for correct target-related responses.

~~SECRET~~

**UNCLASSIFIED**

(U)

The shifting of viewpoint also obviates the problem of the remote viewer spending the entire session time giving meticulous detail on a relatively trivial item, such as a flower, which, even if correct, generally will be of little use in assessing the session. (Once a remote viewer feels he sees something, he tends to hang on to this perception rather than commit himself to a new viewpoint.) It is important to recognize again that with the division of labor between remote viewer and interviewer it is the interviewer's (not the remote viewer's) responsibility to see that the necessary information to permit discrimination among the range of target possibilities is generated, the remote viewer's responsibility being confined to exercise of the RV faculty.

(U) The remote viewer is encouraged to sketch what he sees, even over his objections that he is not an artist, can't sketch, etc. He may do so throughout, or wait until the end of the session if intermittent drawing would distract his concentration. Since drawings tend to be more accurate than verbalizations, this is an extremely important factor for good results.

7. Target Person ("Beacon") Behavior (U)

(U) After obtaining a target card in the manner described earlier, the target person proceeds to the target site indicated.

(U) He is asked to come upon the target location at the starting time so that his view of it is fresh at the beginning of the remote viewing period. He is to then simply pay attention to the environment as dictated by instructions on the target card. At the end of the agreed-upon target viewing time of 15 minutes the target person returns to the lab.

**UNCLASSIFIED**



UNCLASSIFIED

8. Post-Experiment Feedback (U)

(U) When the target person returns, and after all the raw data has been filed, the interviewer, remote viewer, and target person proceed directly to the target site for feedback. This helps to develop the remote viewer's sense of which aspects of his mental imaging process are correct, which are incorrect. This appears to bring the RV trial to closure for the remote viewer, so that when he has a following session, his mind is no longer involved with wondering how he did on the previous one. Only a very experienced subject can function well time after time without feedback, so this is done for each trial to optimize the potential for success.

9. Evaluation Procedure (U)

(U) In a sense, the most critical part of the standard remote-viewing procedure is the evaluation procedure. Any single experiment in remote viewing, even if perfect, could in principle be dismissed as possibly a coincidence. Further, any result less than perfect might be called into question as a generalized "grass is green, sky is blue" transcript that fits every target. Strictly speaking, only blind differential discrimination of transcripts across a series of targets can provide a basis to discriminate between these dismissals and the RV interpretation, although, as we shall see later, certain post hoc transcript-by-transcript evaluation procedures are found to correlate well with blind differential matching procedures.

(U) To obtain a numerical evaluation of the accuracy of a standard six-trial remote viewing series with a given remote viewer, the results are subjected to judging on a blind basis by an SRI research analyst not otherwise associated with the series he is to judge. To be specific, two project personnel acted as interviewers (R. T. and H. P.),

UNCLASSIFIED

**UNCLASSIFIED**

(U)

and two others (E. M. and B. H.) interchanged roles on alternate series as target person and blind judge. When acting as a judge for a given series, that individual was isolated from the viewer and others involved in the series so as to prevent contamination.

(U) In preparation for judging, the remote viewer's tapes are transcribed. The resulting transcripts are then edited only to the extent of deleting information which might act as artifactual cues to a judge, such as references to other targets, or phrases which might indicate the temporal order of the transcripts.

(U) The transcripts (including associated drawings) and target cards, each arranged in their own random order different from the order of target usage, are then turned over to the judge. The judge is instructed to visit the target locations on the basis of the target card instructions, and to blind rank order, on a scale of 1-6 (best to worst match), each of the six transcripts against each of the six target sites, generating a  $6 \times 6$  matrix.

(U) In order to carry out this task, the judge must assess quantitatively the degree of correspondence between a given transcript and target. We have recently developed a concept analysis procedure that provides for just such detailed comparisons. In this new procedure, we begin by analyzing each transcript for its specific content. To accomplish this, the transcript is divided into a list of specific concepts, where a concept may consist of a single word or phrase from the transcript (e.g., "red"), or a single word or phrase that summarizes a lengthy idea (e.g., "shady"). A list of concepts is made for each transcript in a series to be judged. The analysis proceeds by having the judge, who is blind to which transcripts actually match which targets, stand at the first target location on his target list, and for each transcript make an assessment,

**UNCLASSIFIED**

**UNCLASSIFIED**

(U)

concept by concept, on a rating scale of 0 to 10. A rating of zero implies no correspondence whatever between that particular concept and the target site in question, and a 10 implies complete correspondence. Intermediate scores are given in proportion to the extent of the correspondence. Having done this for each of the concepts, one by one, in the first transcript, the judge repeats the assessment as independently as possible for all the concepts in all of the remaining transcripts. He then proceeds to the next target site on the list and repeats the concept assessment for all of the transcripts as applied to that site. Having finished all the travel sites in this manner, the judge computes the average rating score for all concepts in each transcript matched against each target. When there are six trials in the series, there are 36 such averages.

(U) In a second step of the judging procedure, the judge displays his results in a matrix with targets displayed as rows and transcripts displayed as columns. An example from an actual experiment (Viewer 690) is shown in Table 1. At this point in the analysis, the judge submits his results.

(U) A precise measure of the statistical significance of the matrix of target/transcript relations is given by a direct-count-of-permutations method of great generality.\* It is an exact calculation method requiring no approximations such as normality assumptions. Furthermore, the judging process that went into generating the matrix is not required to be independent transcript-to-transcript nor target-to-target. Finally, the statistical evaluation procedure is general enough that, in addition to being applicable to the blind rank order procedure

---

\* (U) C. Scott, "On the Evaluation of Verbal Material in Parapsychology: A Discussion of Dr. Pratt's monograph," Jour. Soc. Psych. Res., Vol. 46, No. 752, pp. 79-90 (June 1972).

**UNCLASSIFIED**

**UNCLASSIFIED**

Table 1

RESULTS OF TRANSCRIPT CONCEPT ANALYSIS  
OF A REMOTE VIEWING EXPERIMENT (U)

(a) Ratings

Targets	Transcripts					
	A	B	C	D	E	F
Shielded Room	3.55	5.85	2.20	3.80	2.90	2.20
Alta Mesa	3.40	4.00	6.05	2.85	3.00	4.70
Ely Chevrolet	3.50	2.60	1.75	2.00	4.45	4.30
Four Seasons	4.90	3.20	4.80	2.80	2.60	4.85
Methodist Church	2.15	2.60	3.50	3.20	4.70	6.45
Library Stacks	4.05	3.90	3.80	3.80	4.30	6.25

(b) Rankings

Targets	Transcripts					
	A	B	C	D	E	F
Shielded Room	3	1*	5	2	4	6
Alta Mesa	4	3	1	6	5	2
Ely Chevrolet	3	4	6	5	1	2
Four Seasons	1	4	3	5	6	2
Methodist Church	6	5	3	4	2	1
Library Stacks	3	4	6	5	2	1

\* Circles indicate target/transcript key.

UNCLASSIFIED

**UNCLASSIFIED**

UNCLASSIFIED

(U)

in use at the present time, it can be applied to analyses in which numerical estimates of target/transcript correspondences are made on the basis of other rank-order or rating scales. This includes arbitrary scale rating arrived at by some complex procedure involving many factors such as occurs in multiple-judge voting; cases in which, for a given target, several transcripts are given the same rating, all transcripts are rated zero, a few transcripts are assigned rank order numbers and the rest are assigned the mean of the remaining rank order numbers, and so forth. The only requirement is that no artifactual information is provided as to the order of targets and transcripts. In particular, it can be shown that if targets are used with replacement or are non-orthogonal, then the method applies even in the case in which there is trial-by-trial feedback and the target pool is known a priori to both remote viewer and interviewer. Thus the possibility of interviewer cueing or subject guessing based on a priori knowledge of the target pool is handled at a fundamental level by a statistical procedure that assumes the worst. The argument is as follows.

(U) In the absence of knowledge as to which transcript was generated in response to which target, one observes that in setting up the target-transcript matrix there are  $n!$  possible ways to label the columns (transcripts), given any particular order of the rows (targets), and vice versa. Thus, there are  $n!$  possible matrices that could be constructed from the raw judging data, all of them equally likely under the null hypothesis that the viewer's remote viewing attempts produce nothing but vague and general descriptions and/or occasional chance correspondences with various target sites. Each matrix has its associated sum on the matrix diagonal corresponding to a possible alignment of targets.

UNCLASSIFIED

**UNCLASSIFIED**

(U) The significance level for the experiment is then determined by counting the number of possible matrices that would yield a result (diagonal sum) equal to or better (i.e., lower sum of ranks in the rank-order case, higher sum of scores in the correspondence-rating case, etc.) than that obtained for the matrix corresponding to the key, and dividing by  $n!$ . This ratio gives the probability of obtaining by chance a result equal to or better than that obtained in the actual judging process. For the results shown in Table 1 we find, by direct computer count of the  $6!$  matrices obtained by interchanging columns, that the probability of obtaining equal or better matching by chance is  $p = 1/6! = 0.0013$ .

(U) This statistical procedure, in use for more than two decades by many researchers, was specifically designed to handle narrative material of the remote viewing type, and it cannot be stressed enough that it is constructed sufficiently conservatively so as to apply even in the limiting case in which the target pool is completely known a priori to all involved, thus handling any possible contamination due to remote viewer guessing or interviewer cueing in protocols of the type used in the SRI RV procedure.

(U) As an overall calibration of the remote viewing process, against which specific examples can be gauged, we can take as a background data base the lengthy collection of 51 remote viewing trials collected over a several-year period with nine viewers, and published in Reference 1. In these trials, viewers were targeted on local targets (bridges, swimming pools, theaters, airports, computers, machine shops, etc.) within a 20-km range of SRI. The quality of the results was such that the judges, who had to determine in a blind fashion which viewer-generated data packages (tape transcripts and drawings) were associated with which target sites, were able to blind match transcripts to targets in first place in roughly half the cases, an exceptionally significant result. As will be shown later, similar results (in fact, somewhat better) were obtained in this program.

**UNCLASSIFIED**

~~SECRET~~

#### IV ORIENTATION PROGRAM--PHASE ONE (U)

(S) In this section we describe the six remote viewing series carried out with each of the client-supplied volunteers. All series have been assessed as to the amount of remote viewing exhibited in each. Four of these series were found, by blind judging, to depart significantly from chance expectation. Finding four such significant series, in a group of six, is sufficient to make the group as a whole statistically significant ( $p = 4 \times 10^{-5}$ ). A description of each trial in each of the series will be presented below.

##### A. Remote Viewing of Local Target Sites (U)

(S) During the months of May, June, and July, six one-week remote viewing series were conducted, one week with each of the six client participants. These series were carried out at the rate of two series per month. The purpose of these initial training activities was to obtain baseline data on each of the participants taking part in a uniform series of trials, and to provide a basis for later evaluation and comparison of their performance in more diverse tasks.

(U) The six remote viewing sessions for each participant were conducted at a rate of one per day, except for Thursdays, when there were two sessions. The project directors divided the interviewing tasks, with RT remaining with the viewer for the first four trials, and HP acting as interviewer for the last two, in every case.

~~SECRET~~

~~SECRET~~B. Summary of the Six Series (U)

(S) The following summarizes our impressions of the thirty-six remote viewing trials carried out in our laboratory, May through July 1979, by the six client participants.

(U) In order to present a coherent assessment of the sessions in this summary, we rate each session individually by a measure we call Accuracy Rating. This is our evaluation as to the correspondences between viewer-generated transcripts and the intended target site. This assessment is carried out on a post hoc basis with knowledge of the target site, and so is not intended to be the equivalent of "blind judging." Its utility is that it provides a relative measure from our standpoint as to the success of the various participants. We rate each transcript on a 0 to 7 scale, with a 0 for no correspondence, and a 7 for a transcript that shows excellent correspondence with essentially no incorrect information, and including good analytical detail (for example, naming the target by name). The scale is shown in Table 2. Again, the 0 to 7 rating is not a blind measure of the level of RV functioning, but rather a procedure for comparing the relative performance of the participants. As we see later, however, the correlation or agreement between our Accuracy Rating system and the results of formal blind judging is high.

1. Viewer No. 155 (U)

(U) Target 1: White Plaza at Stanford University. This trial was the first in the overall group of thirty-six, and also was in our opinion (and that of the blind judge) one of the very best in the series of six with this remote viewer. The viewer correctly identified the main feature of the site as being a plaza with a fountain. He also had a tall column dominating the scene, which could be a match to Hoover Tower, a looming structure nearby. Additionally described were a series of arches,

~~SECRET~~



Table 2

(U) 0-7 POINT ACCURACY RATING SCALE  
FOR TARGET/TRANSCRIPT CORRESPONDENCE (U)

- 7 = Excellent correspondence, including good analytical detail (e.g., naming the site by name), and with essentially no incorrect information.
- 6 = Good correspondence with good analytical information (e.g., naming the function), and relatively little incorrect information.
- 5 = Good correspondence with unambiguous unique matchable elements, but some incorrect information.
- 4 = Good correspondence with several matchable elements intermixed with incorrect information.
- 3 = Mixture of correct and incorrect elements, but enough of the former to indicate viewer has made contact with the site.
- 2 = Some correct elements, but not sufficient to suggest results beyond chance expectation.
- 1 = Little correspondence.
- 0 = No correspondence.

(U)

which are a recurring feature in the buildings surrounding the courtyard.  
Accuracy Rating = 5.

(U) Target 2: Stanford Art Museum. The viewer did not describe this large Greek-columned building at all. He did, however, mention nearby features, such as arches and red-tiled roofs, and indicated that he felt that it was again a "Stanford type" of target. Accuracy Rating = 3.

(U) Target 3: Fire Circle. Among other things, the viewer correctly described a circular depressed area, with descending steps, a squared-off far end, and something in the center. These features are

**UNCLASSIFIED**

(U)

descriptive of the target. However, the viewer also described and drew two other fairly coherent scenes that did not pertain to the target. Consequently the judge who eventually evaluated this series in the blind, ranked this transcript in fifth place, out of six, because of its correspondences to other targets. The viewer also accurately perceived the beacon's activities at the target by stating that, "... he was involved in the movement somehow. He was on or thinking about something that moves, goes around in a circle. It seems to be a circular thing. Because I was getting the feeling of vertigo ...." The beacon stated in his notes regarding his activities at the target that he "... circulate(d) the fountain ..." and "... did a sort of Indian whooping dance as I jumped around the thing ...." Simply rating the transcript and drawings to the actual target, our assessment was Accuracy Rating = 3.

(U) Target 4: Logo. This target is a 6 ft x 12 ft orange metal sculpture on the grass lawn of a chemical company. It is symbolic chain molecule, consisting of four large diamond shapes connected together. The viewer did not describe anything that pertained to the target. His main features were of a gazebo structure. Accuracy Rating = 0.

(U) Target 5: Valombrosa Conference Center. The main feature of his description was a fan shaped structure, somewhat matching the roof design of the principle element of the target. He pictured it as an "arched cave with bars," which led to the blind judge incorrectly matching it to the pedestrian overpass. Accuracy Rating = 2.

(U) Target 6: Pedestrian Overpass. The viewer's initial description was of a "lacey arch," which is a very apt summary of this wire and pipe structure. He went on to describe his "confined feeling." His description then became that of a "narrow alley" and what sounded like a village scene with stucco buildings. His fourth drawing was a reasonable

**UNCLASSIFIED**

~~SECRET~~

(U)

representation of the arched entrance to the overpass. Again, however, there were so many extraneous elements to the viewer's output that our judge ranked this transcript fourth out of six. Rating it only with regard to the individual target, we assigned it an Accuracy Rating = 3.

(S) This remote viewing series was the first to be conducted with a client volunteer. It was judged in accordance with the detailed concept analysis described earlier. The final tally revealed only one correct first-place assignment, and all others fourth-place or less. The series was therefore statistically nonsignificant, according to our evaluation criteria. Our Accuracy Rating assessment agreed fairly well with the blind judging results, both being relatively low because of the viewer's frequent inclusion of erroneous elements along with strongly correct ones in a given transcript/drawing package, a combination that made judging difficult. (Our sum of Accuracy Ratings was 16, the next to the lowest of the six.) In engineering terms this would be a good example of a signal-to-noise problem. There were occasional good examples of signal, but it was generally overwhelmed by the noise.

2. Viewer No. 292 (U)

(U) Target 1: SRI Courtyard. The central feature of this large, enclosed courtyard is a fountain in a square concrete base. The viewer described a number of different architectural forms including domes and columns, which are not at the target site. He also described a small waterfall, however, which is in fact at the site, in a form well illustrated by one of his drawings. In addition, another drawing shows an eight-lobed circular structure that closely resembles the inner portion of the fountain. Because of the many nonapplicable elements of the description, however, this transcript only merits an Accuracy Rating = 3.

~~SECRET~~

**UNCLASSIFIED**

(U) Target 2: Varsity Theatre Arcade. The target is the entry to a motion picture theatre. From the street one sees a double colonnade running from the street to the theatre entry. To the left and right are stucco walls with movie posters behind glass, and down the center is a row of striped umbrellas. The viewer described a tunnel-like structure, receding away from him, and masonry walls, with bright reflections, all relatively apropos. He also drew and described a kiosk structure with a striped coolie-hat top, which bore no resemblance to anything at the target site during the viewing period. When the viewer was taken to the site for feedback following the session, however, it was found that umbrellas matching the striped coolie-hat top had been set up, indicating the possibility of contamination from future remote viewing (FRV) of feedback. Additional evidence along these lines is supplied by the results of the following session.

(U) In general, in this session the drawings were more applicable than the transcript. Accuracy Rating = 5.

(U) Target 3: Glass Slipper Motel. This target is a motel on El Camino Real. The facade is a representation of a fairy tale castle. The viewer didn't describe anything like the target, although he did give a detailed and coherent description of a place that he visualized. One of the consistent items in the viewer's transcript was his reference to big shade trees, an arbor-like effect, and horizontal yellow and orange bands of cloth, supported on wires to make a horizontal awning. Accuracy Rating = 0.

(U) Of some interest, however, is the fact that after taking the viewer to the target site, and confirming that it did not particularly match his description, the interviewer suggested that they have lunch at a new restaurant that had just opened up, several miles away. The restaurant visited had all the features described above. Neither the viewer nor

**UNCLASSIFIED**

(U)

the interviewer had ever seen this, or any similar place before, so one can speculate that the viewer may have experienced FRV overlay from this site.

(U) Target 4: Wallbangers Racquet Ball Court. The target building is situated in relatively open country, immediately adjacent to a pond with three fountain spouts in it. The outbound team initially parked in front of this pond, but then moved the car around to the side of the building because they were concerned that spending any time near the fountain might tend to focus the viewer's attention on this element, rather than on the racquetball club interior.

(U) The viewer described two main elements; a body of water with two or three fountains in it, and a balcony looking down on a geometrical pattern of some sort. The viewer provided a coherent description of the outbound team's activities with regard to their stay on the balcony. However, he described the scene outdoors containing the fountain, as if it were visible from the balcony (which it is not), apparently superimposing the interior/exterior aspects. Accuracy Rating = 4.

(U) Target 5: Airport Tower. The target was the control tower at a small local airport (Palo Alto Airport). Upon arrival at the airport, the target team drove down a short road, passing a tall, metal-braced beacon tower at the entrance, and parking by the smaller, stone control tower. The viewer gave first a description that appears to pertain to the beacon tower at the entrance to the Palo Alto Airport, and then appears to have shifted to the control tower (the actual target) a quarter mile away.

(U) The viewer made a careful sketch of a tall metal tower with diagonal bracing. He called it a mast, with a "plane" at the bottom. When the interviewer asked him about the plane, the viewer said it was a

**UNCLASSIFIED**

(U)

"jack plane" of the type carpenters use to finish woodwork. (This type of symbolism--there were airplanes near the tower--is often seen in remote viewing transcripts.) The viewer then drew and described a globe-and-clouds emblem (FAA symbol) which is on the stone tower door, and was studied by the target team at the site.

(U) Figure 2(a) shows a photograph of the beacon tower, and Figure 2(b) the viewer's initial response. The first paragraph of his comments includes the following: "At first I thought it was a ladder going vertical ... it slowly changed like it was a lattice TV tower. It appears to have three verticals, with diagonals and cross bars. I can't see the top of it, but logic tells me that it would have an antenna; but I see a bell shaped structure instead." This narrative shows a viewer successfully overcoming his analytical prejudice in favor of his actual pictorial images.

(U) Although the control tower rather than the beacon tower was the actual target as far as the outbound team was concerned, we interpret this result as indicating that once in the vicinity of the target at the Palo Alto airport, the taller beacon tower caught the remote viewer's attention. We assigned this session an Accuracy Rating = 6, the highest of the thirty-six trials in this introductory orientation series.

(U) Target 6: SRI Shielded Room. The viewer had a repeating view of an outdoor, turning disk, which condensed for him into a drawing greatly resembling a merry-go-round at a nearby park, a well known target described in our published work. Little of this description resembled the actual target. Accuracy Rating = 0.

(U) Because of the variability of this viewer's results, the blind judging result was nonsignificant. In spite of two zero scores, however, this viewer was fourth place among the six participants with

**UNCLASSIFIED**

UNCLASSIFIED

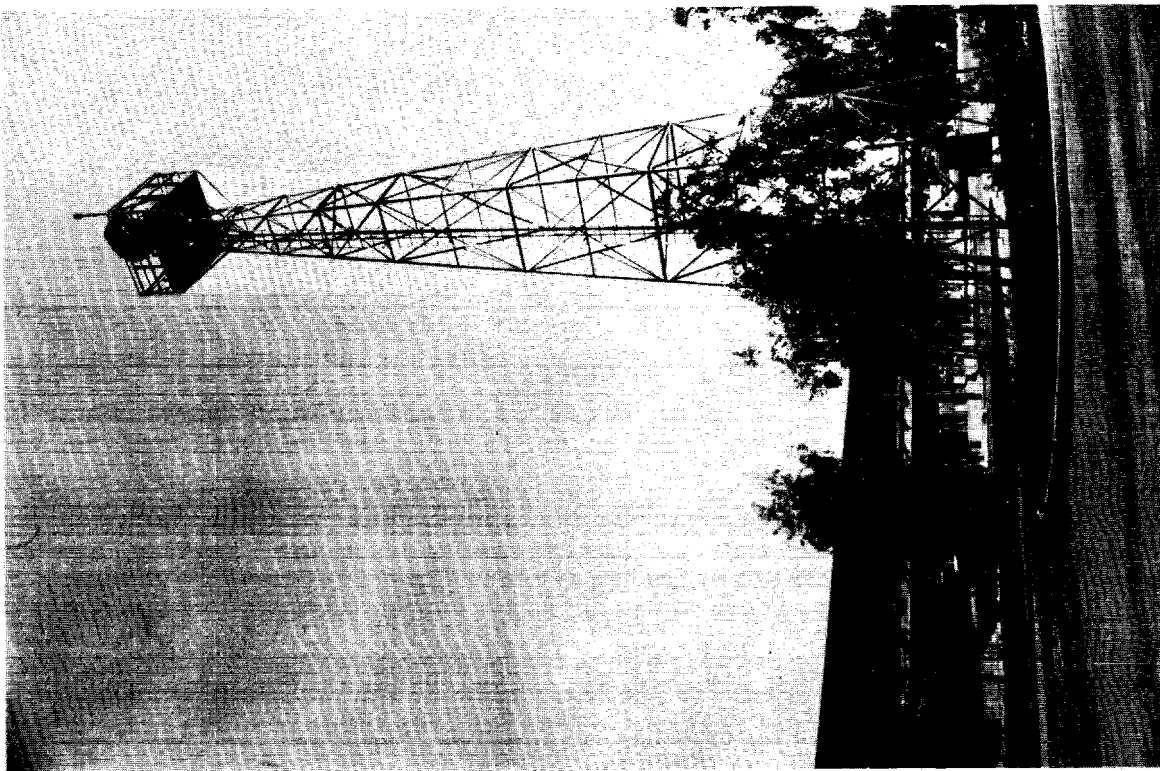
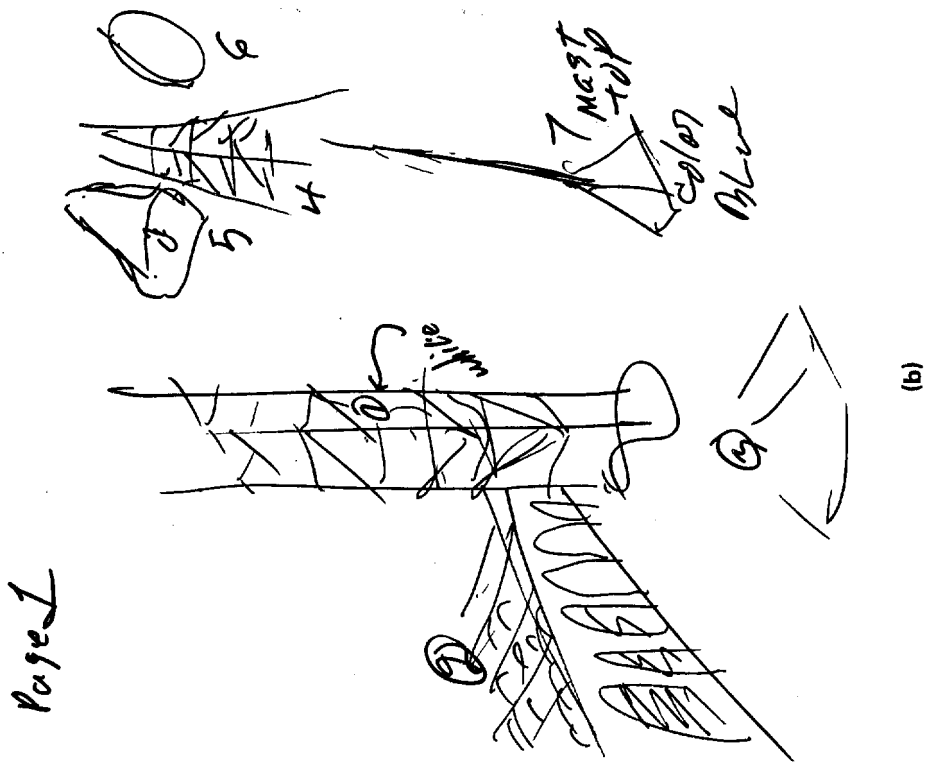

UNCLASSIFIED

FIGURE 2 BEACON TOWER IN VICINITY OF CONTROL TOWER TARGET AT PALO ALTO AIRPORT (a), AND RESPONSE BY VIEWER No. 292 (b) (U)

UNCLASSIFIED

**UNCLASSIFIED**

(U)

regard to accuracy ratings (his sum of Accuracy Ratings was 18). The nonsignificant blind judging result may somewhat underrate his ability (which is highly variable) to do remote viewing; we found his descriptions of the small waterfall, the Varsity Theatre entrance, the airport beacon tower, and the apparent FRV contamination taken together to indicate RV potential not yet under good control.

3. Viewer No. 372 (U)

(U) Target 1: Stanford Art Museum. The viewer described a stone building with a higher central part, and two wings, one on either side. He then drew the building in a careful pen and ink sketch which strongly resembles the target (see Figure 1, Section II earlier). However, there are several other less carefully executed sketches on the same page, and on other pages, including sketches suggesting tombstones, which resulted in this transcript being ranked first place match to a cemetery. The transcript itself had many elements that pertained to items in the museum entry, however, including column design. The judge gave this a second place rank out of six. Accuracy Rating = 4.

(U) Target 2: Baylands Nature Preserve. For reasons yet to be determined, this is the target that in our seven years work is most often described excellently, and in a somewhat characteristic manner. The main feature at this botanical garden at the San Francisco Bay is a wooden walkway from the shore to an observation platform a quarter of a mile away in the salt marsh. This walkway is crossed at right angles by a similar one that follows a row of high-voltage transmission towers. Almost every viewer who has had this target has described a "large cross on the ground." This viewer was no exception. He also characterized it as an outdoor site with no other buildings. Accuracy Rating = 5.

**UNCLASSIFIED**



**UNCLASSIFIED**

(U) Target 3: Alta Mesa Cemetery. The remote viewer reported a recurrent feeling of "rough cut stone." "It feels like a church but it is not a church." He made a drawing of a small arched building that is at the site. "Very peaceful and relaxed," he said. He also had a recurring theme of some kind of stone overhang, which was not at the site, and which resulted in the blind judge assigning this otherwise coherent transcript to the Art Museum. Accuracy Rating = 4.

(U) Target 4: Jungle Gym. The viewer described a large box with curved edges, made of wire-like bent coat hangers. He also had a metal surface rippling and shining in the sun like a child's slide. (A slide was next to the jungle gym target.) He made schematic drawings of both the circular jungle gym, and the slide. He went on to say that the target is more like a sculpture than a building, and indeed the playground elements are in the form of metal sculptures (horse, car, etc.). Accuracy Rating = 5.

(U) Target 5: Salt Pile. This target is a salt refinery on the San Francisco Bay. Its prominent feature is a gleaming white pile of salt about 100 ft high, and 200 ft long, which the viewer did not describe. He did, however, describe an outdoor site with birds and wind, which was correct. He also mentioned some machinery. An additional item that contributed to the judge's ability to correctly match the transcript to the target was his drawing of a large, orange, pillow-shaped structure. This was easily matched to a large rusted quonset hut at the site. He also spoke extensively of a sharp, pointed object that the outbound person was especially interested in. (In fact, RT had picked up a very large salt crystal of this description, and brought it back to SRI.) Although we considered the transcript somewhat nonspecific, the judge was able to match it correctly. Accuracy Rating = 3.

**UNCLASSIFIED**

**UNCLASSIFIED**

(U) Target 6: Brickyard. There are initial descriptions of rectangular objects, and the first drawing looks like a drawing of a brick. The transcript also had discussions of being inside a building, and of views of towers, which are incorrect. He later sees things lined up that look like books on a shelf. Again and again he has "very precise geometric patterns," as "the most important aspect of the place," which is correct. The drawing package has six pages of curved objects and forms that do not apply, however. The viewer also stated, "when I look up I see red, red sky, the sky is all red for some reason ..." which appears to correspond to the beacons' note about spending a significant amount of time "between two very extensive solid walls of red-orange brick." Accuracy Rating = 3.

(U) The sum of Accuracy Ratings for this viewer is 24, the highest in the group. The blind judging with transcript analysis resulted in correct matches to the appropriate targets for four of the six transcripts, and an interchange of the remaining two. This gives four first place matches and two second place matches in the final judging matrix. Using the exact count-of-permutations analysis described earlier, the probability of obtaining by chance a result equal to or better than the one obtained is  $p = 2/6! < 0.003$ . Thus, the odds of obtaining a result of this significance by chance is less than 1 in 300.

(U) The viewer's significant performance was repeated in his second training period at SRI, when he took part in additional trials, which again produced highly significant results.

4. Viewer No. 468 (U)

(U) Target 1: Merry-Go-Round. The target was a child's merry-go-round in a playground sand pile. About 25 ft away is a spiral slide. The viewer's main descriptions were of a large multistory building in a courtyard. Inside this building he has a "free-floating staircase that

**UNCLASSIFIED**

**UNCLASSIFIED**

(U)

is kind of suspended. It turns this way, and then there is a chute," a description that resembled somewhat the spiral slide. However, there was nothing in the drawings or transcript that pertained to the merry-go-round, and the multistory building concept was incorrect, so that a judge would not be able to identify the target from these data. We therefore assigned it an Accuracy Rating = 0, in spite of certain suggestive correspondences to a nearby feature.

(U) Target 2: Windmill. This target is a white-vaned windmill on a country road and has been well described by two previous viewers in past years. This viewer described curving stairs (incorrect) and a circular building like a water tank (correct). Our assessment was Accuracy Rating = 3.

(U) Target 3: Stanford Art Museum. The item of main interest at this site is a 5-ft cube sculpture standing on its corner in front of a columned portico of a Greek-style building. The viewer described a dark rectangular solid sticking out of the front of a building, and drew a careful sketch of pillars that support the front of the entry just behind the cube. The viewer also mentioned track lighting, heavy doors, and an "interior bridge," all of which show good correspondence to elements at the target site. His transcript also had office buildings and cyclone fencing, however, which do not appear at the site. We assigned it an Accuracy Rating = 3, based primarily on the two good drawings of the projecting rectangular solid and the columns.

(U) Target 4: Methodist Church. For this target he described a building with a "sloping roof with windows set into it." He then drew a large sketch of a building with a pointed roof supported from the outside by sloping roof beams. These features accurately represent the main features of the large stone church that was the target. The viewer also

**UNCLASSIFIED**

**UNCLASSIFIED**

(U)

correctly described that the target team went inside the building, and then looked out through windows toward the end of the trial. Accuracy Rating = 5.

(U) We also note that the viewer seemed quite tense to the interviewer during the first three trials. On Thursday, just before trial 4, our contract monitor arrived at SRI to observe the protocol, and particularly the randomization procedure used in target selection. He also observed this trial by joining the outbound target team. From this point forward we noticed a dramatic change (for the better) in the viewer's performance.

(U) Target 5: Four Seasons Arch. "I get the feeling of their walking through an opening in a low wall." That is just what a target team does at an omega-shaped arch in front of a restaurant. The viewer had several arch shapes, together with a carefully drawn wall comprising 300 degrees of a circle, and correctly labeled as being white (although he had it lying on the ground, which is incorrect). The transcript is all arches and walls for the first four pages, and then drifts into buildings and wooden structures which are not at the site. Accuracy Rating = 5.

(U) Target 6: Mount Alverno Conference Center. This target consists of an assembly building with glass doors, and an overhanging shallow-pitched roof that resembles in many details the drawing made by the viewer. He also correctly described the approach to the site over a little bridge with hand rails, and said that the building was locked, so that the target team could not go inside (correct). Further, he described a bridge "that goes nowhere," in striking agreement with a stairway that rises up a hill, and appears to go nowhere, since all one sees at the top of the stairway is the sky. The viewer did not describe a tall stone tower surmounted by a gold cross next to the assembly building, which is

**UNCLASSIFIED**

~~UNCLASSIFIED~~

(U)

considered the main feature of the target site. Our assessment resulted in an Accuracy Rating = 5, because of the good drawing of the main building, and an accurate description of the place as being "quite like a church but not exactly a church itself."

(U) Sum of Accuracy Ratings = 21. We note that this viewer's ability to make clear drawings of his mental images (he is a professional illustrator) is a great asset both to himself in describing his remote viewing experiences, and to those trying to evaluate his descriptions. Blind judging gave this series 4 first, 1 second, and 1 fourth place match ( $p < 0.003$ , or odds of less than one in 300 for such a matching profile to occur by chance alone).

5. Viewer No. 518 (U)

(U) Target 1: Stanford Shopping Center. The target is the central courtyard of the Stanford Shopping Center. It is a large rotunda surrounded by high arches and is paved with tiles in a circular pattern. The pedestrian avenues leading away from this hub have fountains and large planters with flowers. The viewer drew and described a round fountain with a spray, located close to a rectangular box with something dark in it. This transcript did not contain a description of the central focus of the target, although many elements could be found in the nearby pedestrian avenues. Accuracy Rating = 3.

(U) Target 2: Bowling Alley. The viewer described an outdoor scene with a large building with overhang (correct), with many curves and oaken doors (incorrect). Inside he had a complex structure like a throne. We found little resemblance to the target. Accuracy Rating = 1.

(U) Target 3: Alta Mesa Cemetery. The viewer described and drew several buildings, which were not apropos, and described "a place

~~UNCLASSIFIED~~

**UNCLASSIFIED**

(U)

of fun and recreation." He had a recurring bicycle throughout the transcript which also could not be matched. Our Accuracy Rating = 1.

(U) Target 4: Hoover Tower. The viewer had the feeling that he was "abnormally high." He also saw semicircular ends of a dark tunnel in which he was standing. The target team was on the observation deck of Hoover Tower. The deck is surmounted with a domed ceiling (that the viewer described) and each of the four sides is a large floor-to-ceiling arch, making the view outside much brighter than the space inside the observation deck, resulting in a tunnel-like aspect. The viewer clearly had the idea of shade, coolness, arches, and height. He also drew a "reddish inverted cone" and labelled it as such, which was a good match of the top of the tower. The beacon was slightly acrophobic during the experiment, and the viewer detected "tension, anxiety around me and below me ...." Accuracy Rating = 4.

(U) Target 5: Swimming Pool Complex. The viewer described  
"Approved For Release 2000/08/07 : CIA-RDP96-00788R001300170001-0"  
"a two-dimensional rectangle that is not a structure," in a plaza sur-  
rounded by walls. His images finally resolved into a three-tiered fountain.

(U) Target 6: Miniature Golf Course. The target team concentrated their attention on a red A-frame schoolhouse at a miniature golf course. The viewer several times described teepee-shaped structures (some resemblance to certain structures on the course), but the main portion of his description pertained to the inside of a hall with much confusion, and a row of what looked like display cases (a possible match to a building at the site containing rows of pinball machines). Accuracy Rating = 2.

(U) The sum of Accuracy Ratings for this viewer was 15, which is the lowest of the six participants. In spite of this low rating, formal blind judging resulted in separation of signal from noise, awarding these data 4 first-place and 2 second-place matches ( $p = 2/6! < 0.003$ ), which is a statistically significant outcome for this series. Since these trials this viewer has returned to SRI for an additional two weeks of work. During that time he performed quite well on the remote viewing of slides, hidden objects, and distant coordinates. These additional trials are discussed in the next section.

6. Viewer No. 690 (U)

(U) Target 1: Alta Mesa Cemetery. The viewer, on this first trial, had a very diffuse transcript--mainly outdoors, grass, reeds, and trees, in a natural, not man-made environment. The viewer had low cliffs nearby. The drawings were relatively nonspecific. Because of the outdoor naturalistic description, the Accuracy Rating = 2.

(U) Target 2: Four Seasons Restaurant Arch. The target is a large white omega-shaped stone arch set into a wall in front of a restaurant. The subject described "a white dome supported by pillars," and also a fence. Throughout the brief two-page transcript there was only a "gazebo" like structure that one can see through, and a fence. Accuracy Rating = 4.

**UNCLASSIFIED**

(U) Target 3: Shielded Room. The target is a small rectangular screen-room, about 4 by 8 by 7 ft high. The principal feeling of this target is one of confinement. The viewer said, "he seems inside a square something, looking out through a square. It's dark inside. It is not terribly high, 6 ft maybe." The drawing shows a rectangular structure marked "6 ft wide." Our assessment of the viewer's description is Accuracy Rating = 5.

(U) Target 4: Automobile Showroom. The target is a hexagonal glass building with a conical roof. The viewer's first impression was of "a glass bottle with a thin neck." "I keep getting the impression of glass, lots of glass objects." "It is some kind of store." The viewer felt "bad vibes" from the place; it seemed threatening. It turned out that HP, the outbound person, was sent to an automobile showroom and was pretending to be interested in a new car, attracting the salesmen in the showroom. He came back reporting that it was one of the most unpleasant outbound experiences he has had. The drawings were diffuse, but because of the essentially correct, though exaggerated emotional perceptions, it received an Accuracy Rating = 4.

(U) Target 5: Palo Alto Library. The outbound team stood between the shelves in the library stacks. The viewer did not describe anything about the library, and our assessment was Accuracy Rating = 0.

(U) There was an interesting facet in connection with this trial, however. The viewer described a cornfield with rows of corn ready for picking, etc. When we heard the tape for this trial we could think of no such place in the city of Palo Alto. But in accordance with our usual protocol, we took the viewer back to the target site. As we were parking the car, the viewer looked out the left window of the car and exclaimed, "that's my corn field." Immediately adjacent to the public library, there is a community garden which this year is devoted entirely

**UNCLASSIFIED**



UNCLASSIFIED

(U)

to corn. So, one may speculate that the viewer accessed this adjacent area as the target team arrived at their site.

(U) Target 6: Methodist Church. All the images in this transcript pertain to a one-story building with "an inverted V roof." The main feature of the target is just such a roof. The viewer also correctly identified the target as being a building in downtown Palo Alto. Since there were no identifying characteristics given, we assigned it an Accuracy Rating = 4.

(U) The sum of the Accuracy Ratings for the six trials is 19, which is the third highest in the group. One of the main features that contribute to this viewer's comparatively high rating is that these transcripts are relatively free of incorrect material; the viewer does not have a lot to say, but what is said is largely correct. We consider this to be a very desirable characteristic.

(U) The formal judging for this series yielded five first place matches. The probability of obtaining such a result by chance is  $p = 1/2! < 0.002$ . (The most significant of the study.)

C. Analysis of Transcript Correlations (U)

(U) Before summarizing the judging results of Phase One, we digress to discuss an interesting and potentially important observation. During the past seven years of research, we have carried out a total of more than two hundred remote viewing trials with several viewers. Since the target locations for these trials are selected by random processes from previously prepared target pools, individual targets will recur from time to time for different viewers. We have observed that certain targets are almost always described correctly, while certain others are described in a consistent idiosyncratic fashion even when the description is incorrect.

UNCLASSIFIED

**UNCLASSIFIED**

(U)

For example, the Baylands Nature Preserve, which is a botanical garden in the marshes of San Francisco Bay, has been a target several times in the last two years. This large open area is reached by a wooden walkway about a quarter of a mile long. This walkway is crossed at its midpoint by another walkway under some high-voltage transmission wires. Nearly all viewers (including Viewer 372 from this program) describe this site in terms of a "large cross lying on the ground."

(U) In the Phase One series, two large churches in the target pool were not described by Viewers 468 and 690 in terms of their rather prominent crosses; instead, attention was called to their "tall pointed roof" (correct).

(U) The windmill target has never been described in terms of its four large white blades, but instead by reference to a circle with four quadrants marked off, and a feeling of circular motion, even though the windmill does not move. The responses of Viewer 468 and an earlier subject are shown in Figure 3.

(U) We take these consistent perceptions as suggesting that viewers do not necessarily experience a target location in the same terms as they would if looking at the target visually. Instead, some kind of simplifying transformation may take place during the viewer's perception of the target site.

(U) An example of such simplification is shown in Figure 4, in which the target is a large cross on a hilltop. Two viewers, 155 and 372, described and drew it as a tall isosceles triangle.

(U) In a recent experiment, a viewer (No. 155) described a target as "squares within squares within squares." His drawing and description were quite parallel to a drawing made by a subject six years

**UNCLASSIFIED**

**UNCLASSIFIED**

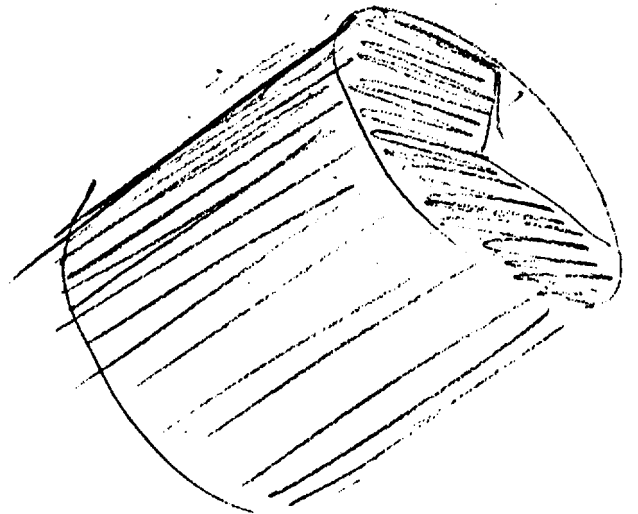
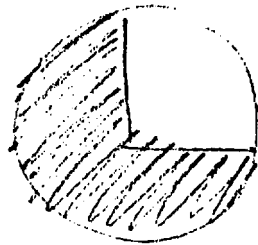
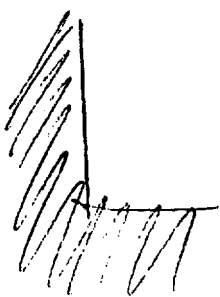
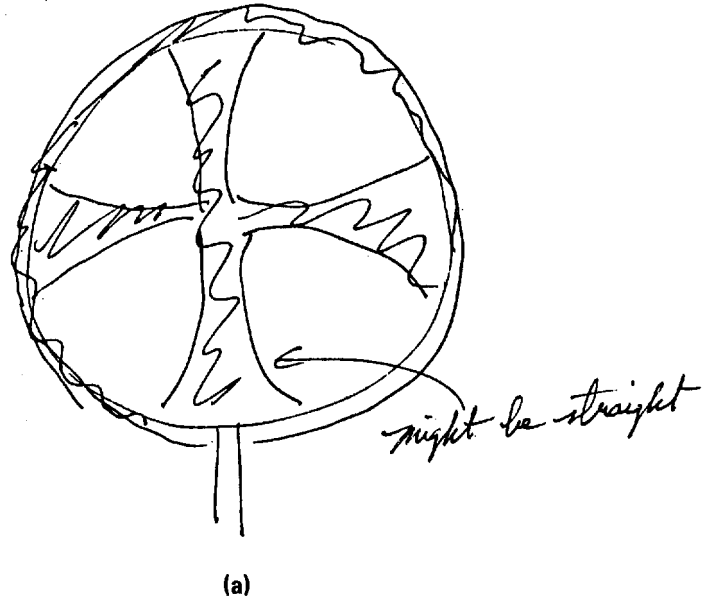
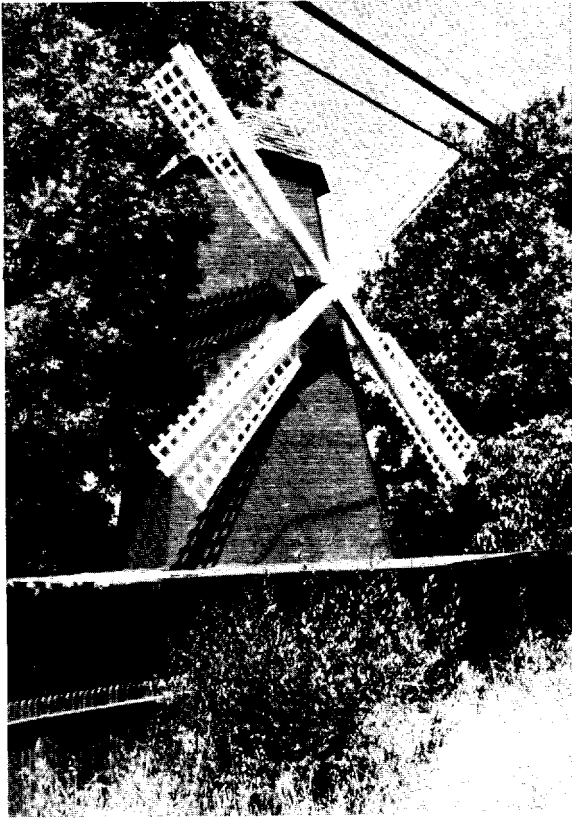

(b)

**UNCLASSIFIED**

FIGURE 3 WINDMILL TARGET AND RESPONSES BY VIEWERS S5 (a), AND No. 468 (b) (U)

**UNCLASSIFIED**

**UNCLASSIFIED**

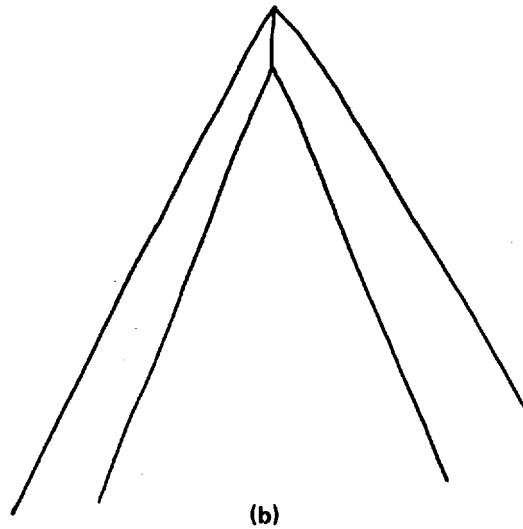
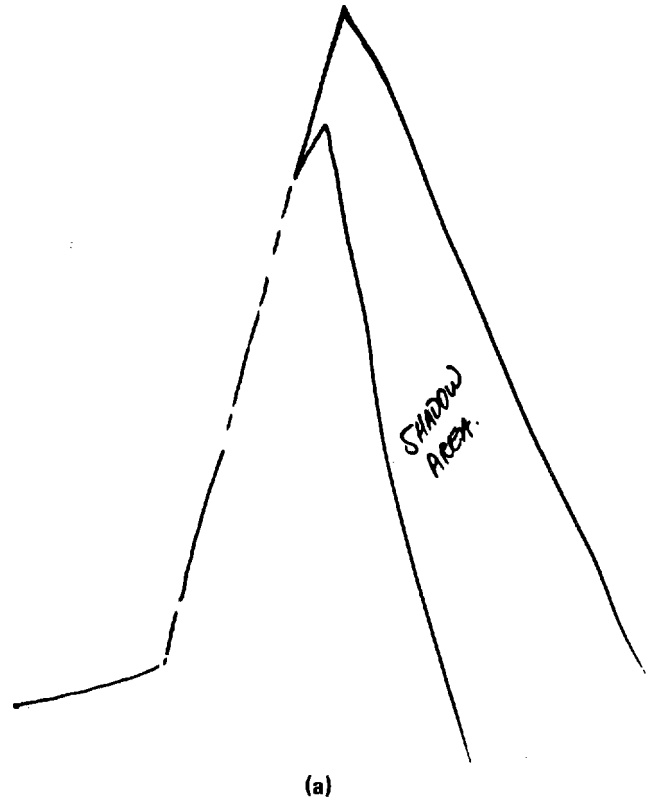

**UNCLASSIFIED**

FIGURE 4 REDWOOD CITY CROSS TARGET, AND RESPONSES OF VIEWERS 372 (a), AND 155 (b) (U)

**UNCLASSIFIED**

**UNCLASSIFIED**

(U)

earlier in response to the same target, a pedestrian overpass. The responses of both viewers are shown in Figure 5.

(U) Since the subject in the laboratory is not perceiving the target visually, it seems unrealistic and unwarranted to assume that his experience (perception and conceptualization) of the target should necessarily always be photographic. In a different perceptual modality, if the only data a person obtained about a trumpet was its sound, he would be able to recognize it each time it was heard, but he would have little information about its visual or physical aspects. On the other hand, after he had received visual feedback on his perceptions of many different musical instruments, the viewer (listener) would be able to learn the particular transformation between the sound of the instrument and its visual appearance. In a similar manner, the occurrence of simple, recurring and archetypical responses to a given target in remote viewing may signal the possibility that the underlying transformations can be learned and categorized.

D. Summary of Judging Results for Local Target Sites (U)

(U) We have described earlier in some detail how a judge arrives at a numerical ranking of the trials in a formal blind evaluation of a series, by use of concept analysis of the transcripts. The overall results of the formal judging are shown in Figure 6. Although in blind ranking one would expect one first, one second, ... one sixth place match for each person, or six of each for the six viewers combined, we find in fact that over half of the transcripts were first-place matched to the appropriate target. The result recapitulates that obtained in our laboratory in our original study published in the March 1976 Proc. IEEE.

(U) In addition, in order to arrive quickly at a trial-by-trial assessment, we made use also of a simple post hoc rating technique of a

**UNCLASSIFIED**

**UNCLASSIFIED**

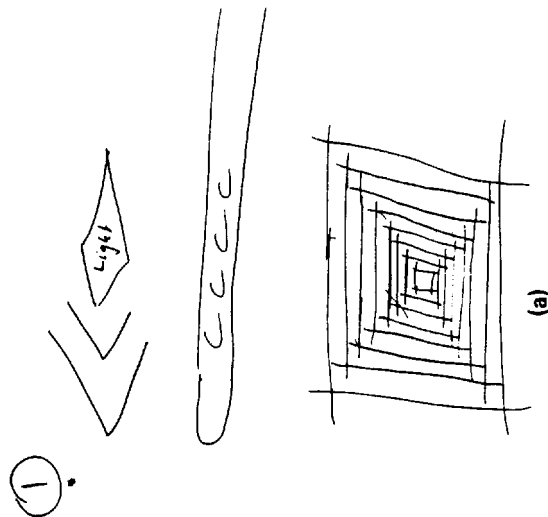
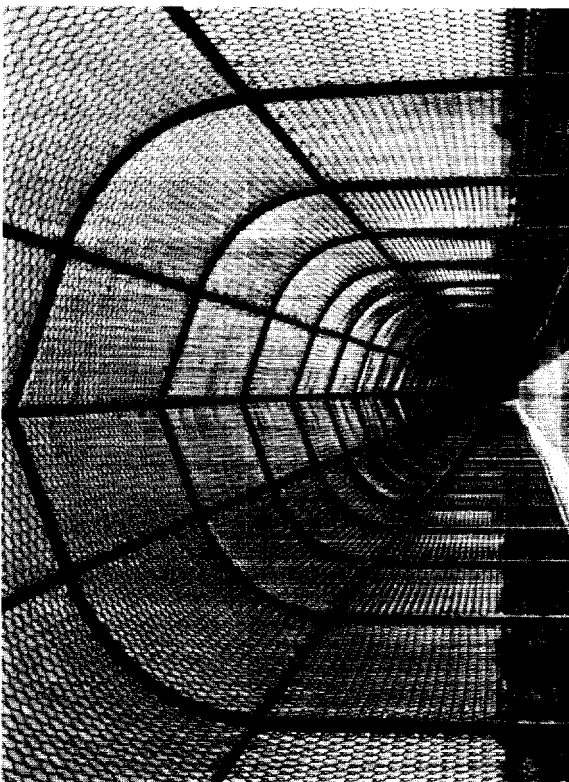
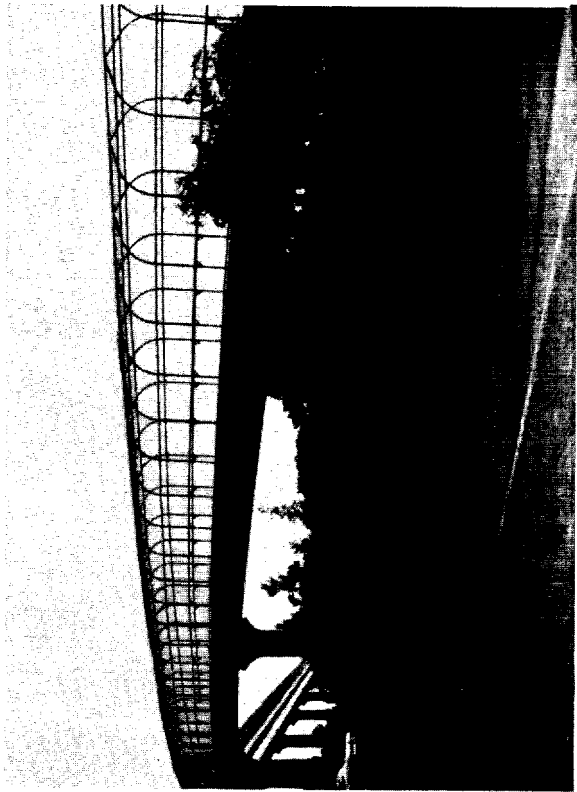

(b)

(a)

**UNCLASSIFIED**

FIGURE 5 PEDESTRIAN OVERPASS TARGET, AND RESPONSES OF S4 (a), AND No. 155 (b) (U)

**UNCLASSIFIED**

UNCLASSIFIED

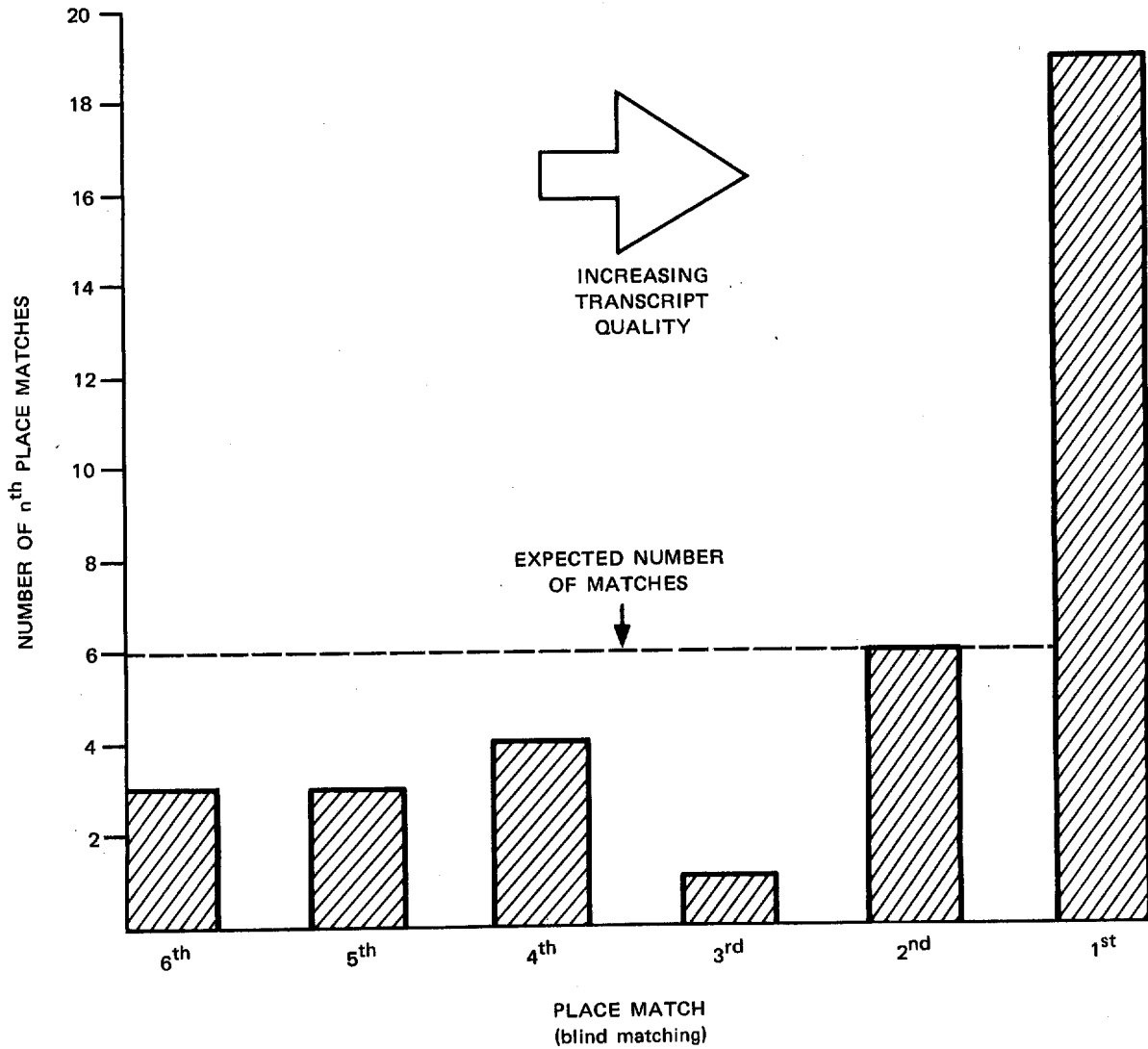

UNCLASSIFIED

FIGURE 6 DISTRIBUTION OF 36 TARGET/TRANSCRIPT CORRESPONDENCES FOR LOCAL TARGET SITES (6 subjects, 6 transcripts each), SHOWING MORE THAN 50% FIRST-PLACE MATCHES

UNCLASSIFIED

~~SECRET~~

(U)

type devised by the client. In this approach one rates as "perfect" (e.g., 7 on a 0-to-7 scale) a transcript in which the target is unequivocally identified. If there is no apparent relationship between the transcript and the intended target, on the other hand, the transcript is rated 0. For intermediate results, an intermediate rating is assigned, as indicated earlier in Table 2. All transcripts were given a numerical Accuracy Rating, using the 0-to-7 scale, in the presence of the contract monitor. The summary data for the two judging processes are tabulated in Table 3.

(U) We are now in a position to compare mathematically our Accuracy Rating of the transcripts (post hoc evaluation scale) with the formal ratings of the same transcripts by a blind judge. In Figure 7 we have plotted a comparison of the Accuracy Ratings (vertical scale) and the blind-judge rankings (horizontal scale). We have also calculated the correlation coefficient between these two sets of ratings for the 36 transcripts/target pairs evaluated by both procedures. For the 36 pairs, the correlation coefficient is  $r = 0.59$ . The numerical probability of a correlation this high or higher occurring by chance between "uncorrelated" data over the same range of values is only one in twenty thousand ( $p = 5 \times 10^{-5}$ ).

(U) This important result shows that a post hoc Accuracy Rating technique similar to that used by the client organization to evaluate transcripts and viewer performance is very well correlated with objective blind matching normally used in psychology to evaluate data of this type.

#### E. Phase-One Conclusions (U)

(S) In the first phase of this technology transfer program we have carried out six series of remote viewing trials, one series with each of

~~SECRET~~



UNCLASSIFIED

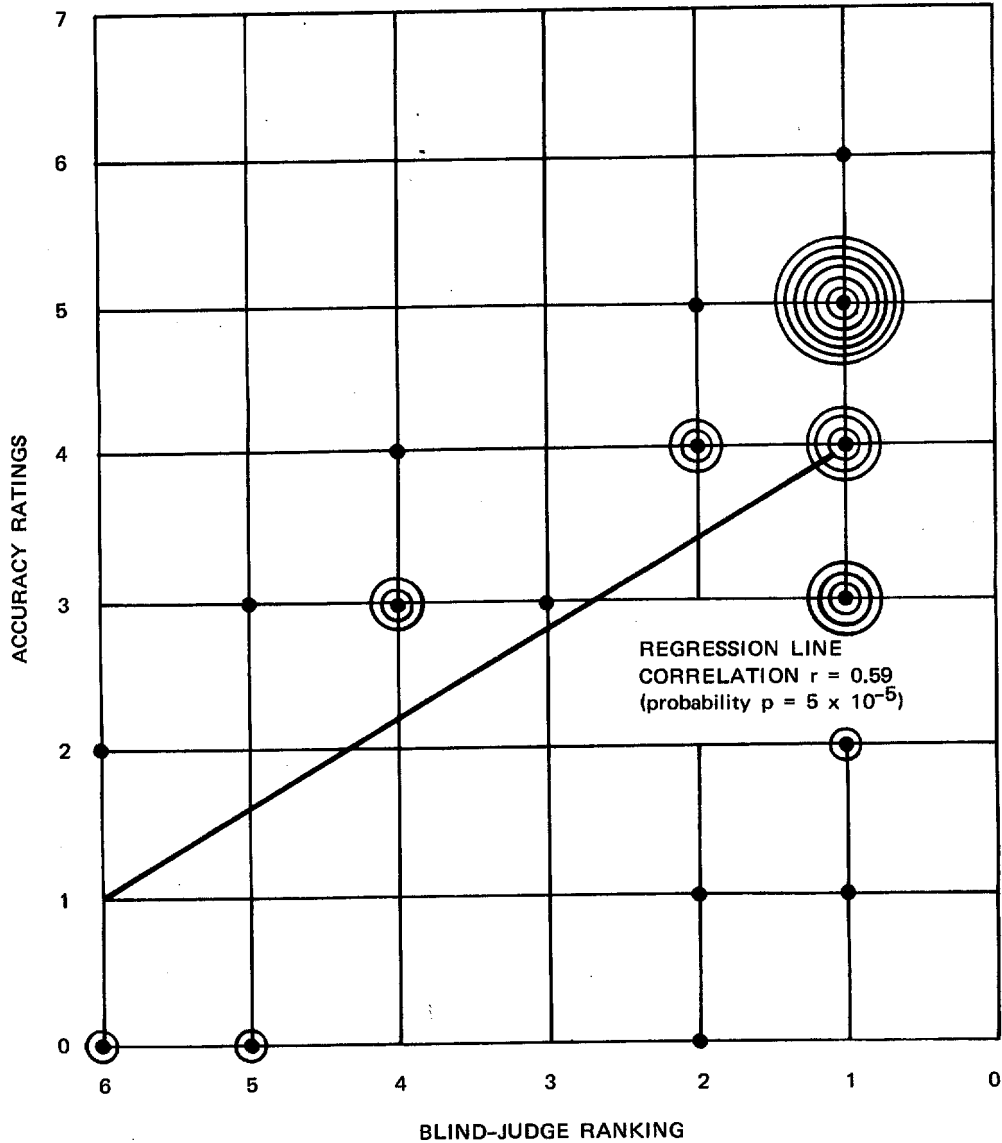

UNCLASSIFIED

FIGURE 7 COMPARISON BETWEEN BLIND-JUDGE RANKINGS AND ACCURACY ASSESSMENTS. Blind judging provides objective support for the accuracy rating evaluation process, in that the high-accuracy-rated transcripts are likely to be first-place matched (in the blind) to the appropriate target.

UNCLASSIFIED

**UNCLASSIFIED**

Table 3

(U) TOTAL SCORES FOR EACH OF THE SIX VIEWERS  
IN PHASE-ONE ORIENTATION PROGRAM (U)

Viewer No. 155

<u>Target</u>	<u>Blind Place Match</u>	<u>Accuracy Rating</u>
White Plaza (Stanford)	1	5
Stanford Art Museum	4	3
Fire Circle	5	3
Logo	6	0
Valombrosa Conference Center	6	2
Pedestrian Overpass	4	3
	NS (nonsignificant)	16

Viewer No. 292

<u>Target</u>	<u>Blind Place Match</u>	<u>Accuracy Rating</u>
SRI Courtyard	3	3
Varsity Theater Arcade	2	5
Glass Slipper Motel	6	0
Wallbangers Racquetball Court	4	4
Airport Tower	1	6
Shielded Room	5	0
	NS	18

**UNCLASSIFIED**

UNCLASSIFIED

Table 3 (continued)

Viewer No. 372

<u>Target</u>	<u>Blind Place Match</u>	<u>Accuracy Rating</u>
Stanford Art Museum	2	4
Baylands Nature Preserve	1	5
Alta Mesa Cemetery	2	4
Jungle Gym	1	5
Salt Pile	1	3
Brickyard	1	3
	<u>          </u>	<u>          </u>
	p < 0.003	24

Viewer No. 468

<u>Target</u>	<u>Blind Place Match</u>	<u>Accuracy Rating</u>
Merry-Go-Round	2	0
Windmill	1	3
Stanford Art Museum	4	3
Methodist Church	1	5
Four Seasons Restaurant Arch	1	5
Mt. Alverno Conference Center	1	5
	<u>          </u>	<u>          </u>
	p < 0.003	21

Viewer No. 518

<u>Target</u>	<u>Blind Place Match</u>	<u>Accuracy Rating</u>
Stanford Shopping Center	1	3
Bowling Alley	1	1
Alta Mesa Cemetery	2	1
Hoover Tower	1	4
Swimming Pool Complex	2	4
Miniature Golf Course	1	2
	<u>          </u>	<u>          </u>
	p < 0.003	15

UNCLASSIFIED

~~SECRET~~

Table 3 (concluded)

Viewer No. 690

<u>Target</u>	<u>Blind Place Match</u>	<u>Accuracy Rating</u>
Alta Mesa Cemetery	1	2
Four Seasons Restaurant Arch	1	4
Shielded Room	1	5
Automobile Showroom	1	4
Palo Alto Library Stacks	5	0
Methodist Church	1	4
	<u>1</u>	<u>4</u>
	p < 0.002	19

Note: The probability of obtaining 4 significant series out of 6 by chance is itself significant at odds of less than one in ten thousand.

(S)

the six client-supplied volunteers. All but one of these individuals had little experience with psychic functioning in general, and all had only limited introductory experience with the remote viewing protocols of SRI in particular before their participation in the SRI program. The goal of this program was to familiarize the individuals with these protocols and attempt to achieve enhanced levels of functioning (as compared with chance expectation).

(S) Of the six viewers taking part in the trials, four carried out series that showed success sufficient to reach individual statistically significant departure from chance expectation, as measured by blind matching of each of the viewer's six responses against the six target locations used in his series. Finding four participants out of six reaching statistical significance at  $p < 0.05$  results in the entire group of trials

~~SECRET~~

~~SECRET~~

(S)

being significant ( $p = 4 \times 10^{-5}$ ). We therefore conclude from the Phase-One results that the client participants as a group showed remote sensing abilities that departed strongly from chance expectation.

~~SECRET~~

~~SECRET~~

V ORIENTATION PROGRAM--PHASE TWO (U)

(S) In this second phase of the orientation/training program, five of the six original participants returned to SRI for an additional two weeks of exposure to various remote viewing exercises. One of the continuing questions in our examination of remote viewing is the determination of what constitutes a target, of crucial importance in operational applications. To obtain data relevant to this question, we carried out two series of remote viewing trials, with two individuals who were asked to describe the contents of 35-mm slides representing Bay Area locations. We wanted to determine whether the viewer would describe the slide itself or the target site of which it was taken. The results seem to indicate that it is the slide as opposed to the target site, that is perceived and described in this series.

(S) A second area to be examined was that of precognition, or future remote viewing (FRV) in which a viewer is to describe a slide that will be shown to him at a later time, under conditions where the slide had not yet been chosen at the time of his description. This situation corresponds to certain operational trials, in which we have been asked to describe a remote geographical target as it would appear at some later time. We have found good evidence for the successful outcome of such trials, and our goal here was to attempt to obtain further information potentially useful in learning how to increase the accuracy and reliability of such functioning.

~~SECRET~~

UNCLASSIFIED

A. Remote Viewing (RV) of 35-mm Slides (U)

(U) The purpose of this series of trials, in addition to determining whether the slide or actual site is accessed, was to determine whether a remote viewer could describe the contents of a 35-mm slide of a target site with the same accuracy that he describes an actual target site. A slide trial constitutes a finer-resolution task and involves a more ephemeral target, as compared to an actual target site, and therefore some differences might be expected.

(U) The protocol was as follows. The viewer was located alone in the third floor laboratory of the Radio Physics Laboratory Building, and asked to describe the contents of slides projected on the wall of an office trailer in a parking lot 300 ft away. The target slides for these trials were photographs of the 60 San Francisco Bay Area sites used in the remote viewing trials of Phase One. The use of this particular target pool allows us to compare the quality of the descriptions that are elicited in trials using the slides, with the quality of descriptions involving the actual targets.

(U) A trial series consists of six slides, and the viewer is given feedback after each individual trial, before the start of the next. (This is done to avoid displacement, known to occur in parapsychological experiments where trial-by-trial feedback is not provided, in which a viewer might tend to describe a target slide from elsewhere in the series, rather than the one specific to the trial of interest, i.e., just projected.)

(U) The viewer is monitored via a one-way open intercom connected to the room in the trailer in which the slide is being shown to the series monitor.\* The session is tape recorded at the latter end of the link.

---

\* (U) A second intercom to the subject can be activated by the monitor by a push-to-talk switch in the trailer.

UNCLASSIFIED

**UNCLASSIFIED**

(U)

To begin, after the viewer announces that he is ready, the monitor selects a slide by random number generator. No feedback is provided to the viewer until the viewer has indicated that he is finished and the monitor has gone to the room in which the viewer has been working and has collected his drawings. A session typically lasts about fifteen minutes.

1. Viewer No. 372 RV (U)

(U) The first series of six trials was carried out by Viewer 372 during his second two-week period at SRI. The six target slides were of the following targets:

- (1) Alta Mesa Cemetery
- (2) Ultra-modern Dome House
- (3) Pedestrian Overpass
- (4) Mount Alverno Conference Center
- (5) Redwood City Cross
- (6) Stanford Shopping Center Pavilion.

(U) Our post hoc personal impression was that three of the six descriptions were good matches to the target slides, as indicated by our Accuracy Ratings of 3, 4, 3, 4, 3, and 5, respectively.

(U) The results were also formally evaluated by a blind judge using the concept analysis techniques being applied to the local target series of Phase One. As per standard procedure, the transcript/drawing response packages and target material (slides) were turned over to the judge, each in a separate random order different from the order of target usage. Again, the transcripts were edited only to the point of deleting information that could provide artifactual cues to the judge, such as references to other targets or temporal order. (Only five of the target/transcript pairs were submitted for judging, since the judge had inadvertently

**UNCLASSIFIED**



**UNCLASSIFIED**

(U)

been exposed to one of the results [Target 4] presented at a briefing as an example of excellent slide viewing.)

(U) The judge was asked to blind rank order, on a scale of 1 to 5, best to worst match, each of the transcripts against each of the targets, generating a  $5 \times 5$  matrix of the five target/transcript pairings. Three slides and transcripts were directly matched, one was matched second place, and one was matched third place. The direct-count-of-permutations analysis of the matrix yielded a result significant at  $p = 2/120 = 0.017$ , or odds of one in sixty of obtaining such a result by chance matchings.

(U) Three of the drawings and slide targets for this viewer are shown here as Figures 8 through 10. We conclude from these results that viewers can describe target slides, and from our analysis of the content of the transcripts it appears that they are describing the slides as projected, not the overall target location.

2. Viewer No. 518 RV (U)

(U) A similar series of six trials was conducted with Viewer 518. His six target slides were:

- (1) Laundromat interior
- (2) Varsity Theatre arcade
- (3) White victorian house
- (4) Sylvania dome building
- (5) Glass Slipper Motel
- (6) A locomotive slide in a playground.

The viewer made what we consider to be three excellent sets of drawings to correspond with the Theatre, the Victorian, and the Motel targets. These three drawing/target pairs are shown here in Figures 11 through 13.

**UNCLASSIFIED**

UNCLASSIFIED

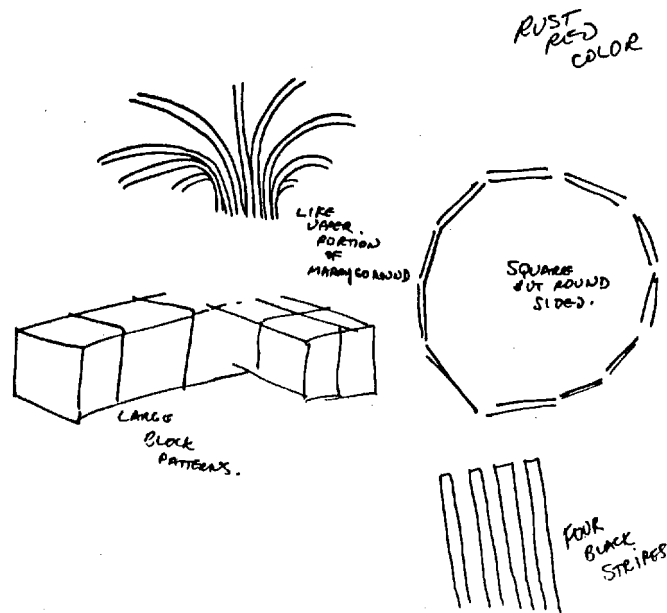
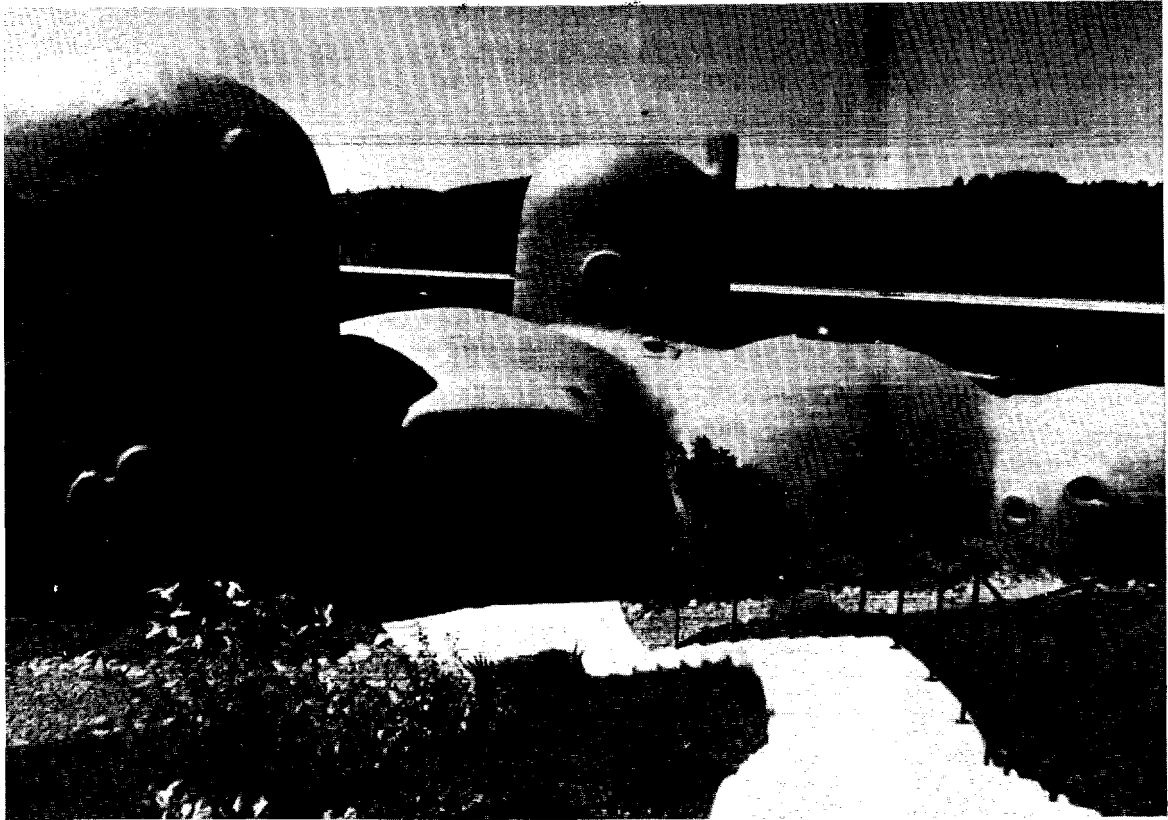

UNCLASSIFIED

FIGURE 8 ULTRA MODERN DOME HOUSE--TARGET, AND VIEWER 372 DRAWING (U)

UNCLASSIFIED

**UNCLASSIFIED**

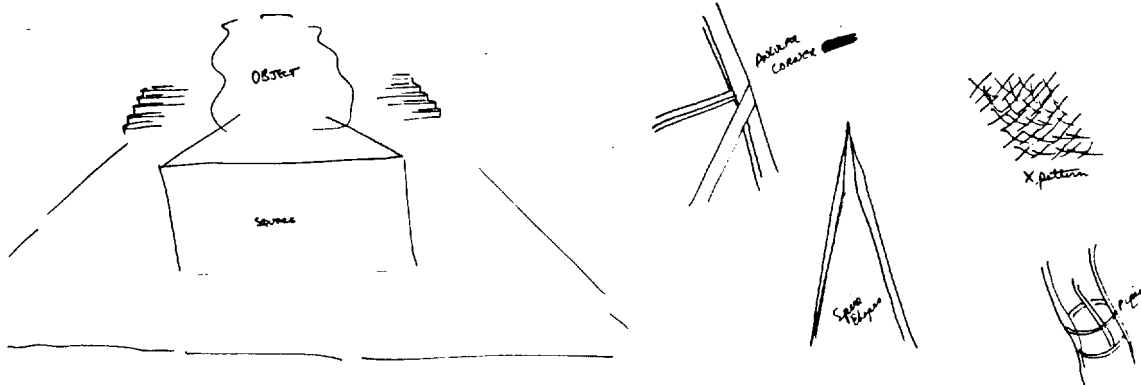
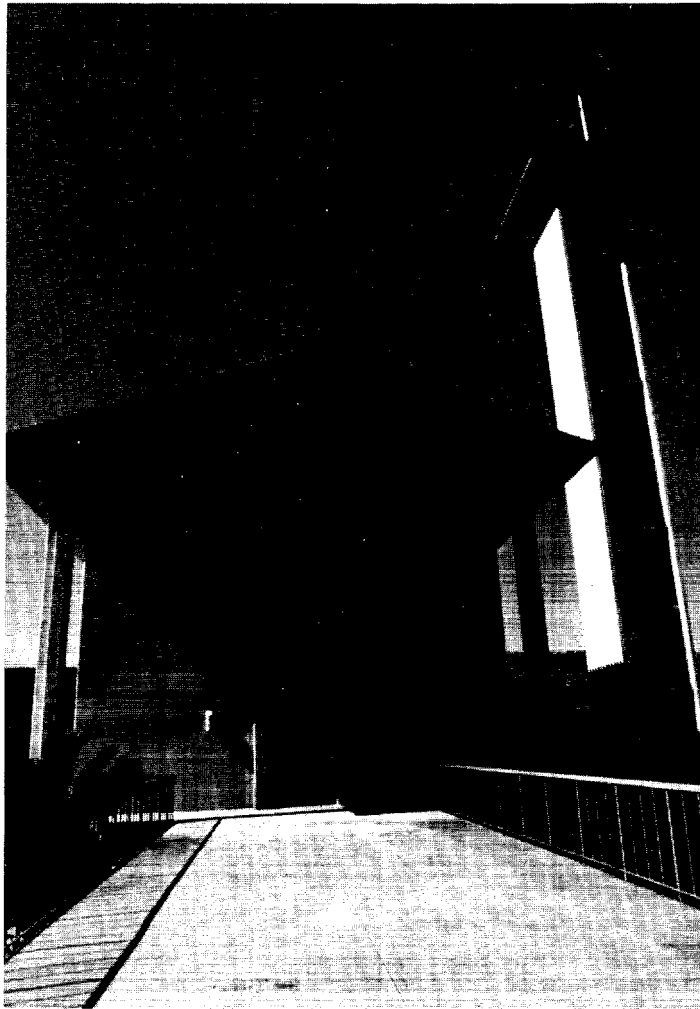

**UNCLASSIFIED**

FIGURE 9 MOUNT ALVERNO CONFERENCE CENTER, AND VIEWER 372 DRAWING (U)

**UNCLASSIFIED**

UNCLASSIFIED

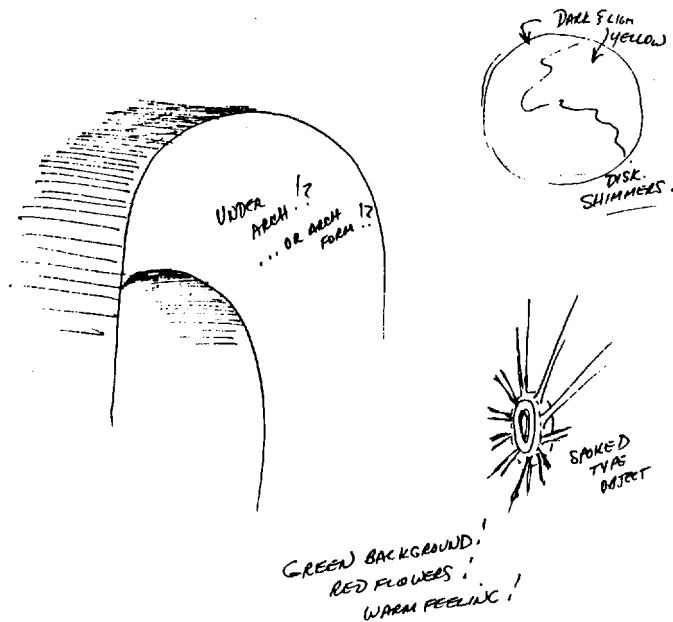
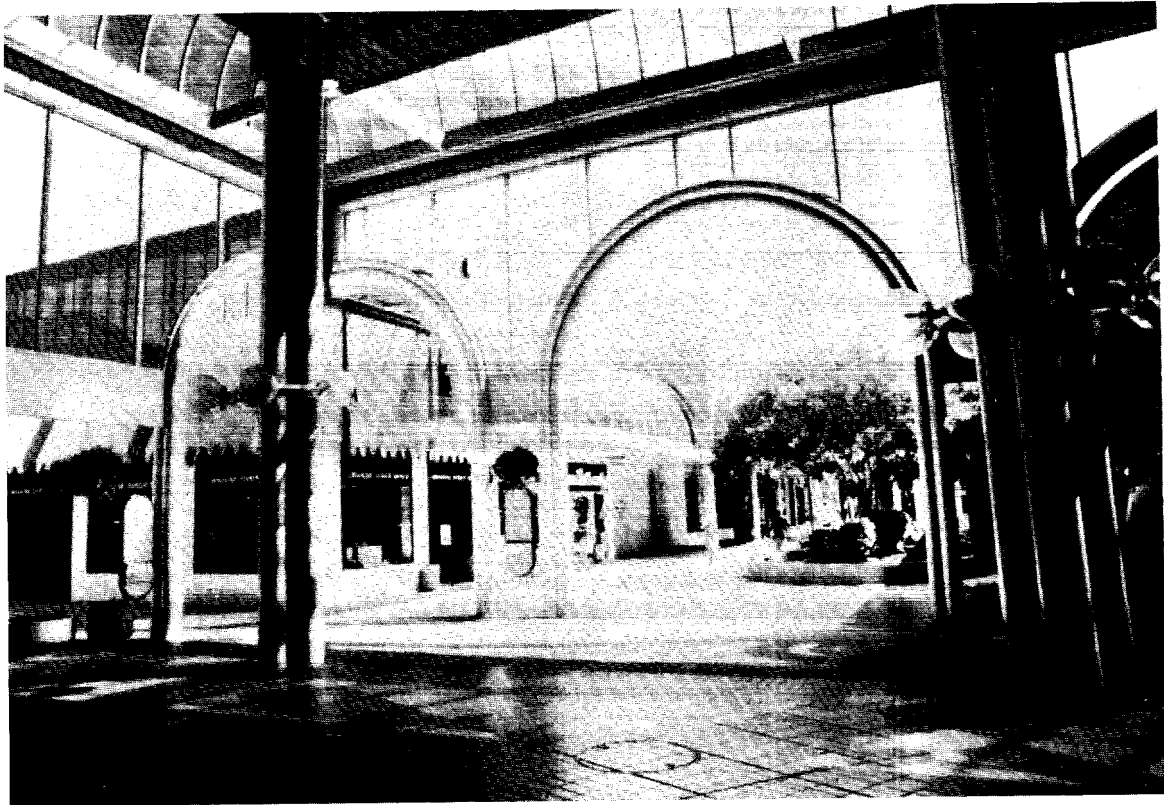

UNCLASSIFIED

FIGURE 10 STANFORD SHOPPING CENTER--TARGET, AND VIEWER 372 DRAWING (U)

UNCLASSIFIED

**UNCLASSIFIED**

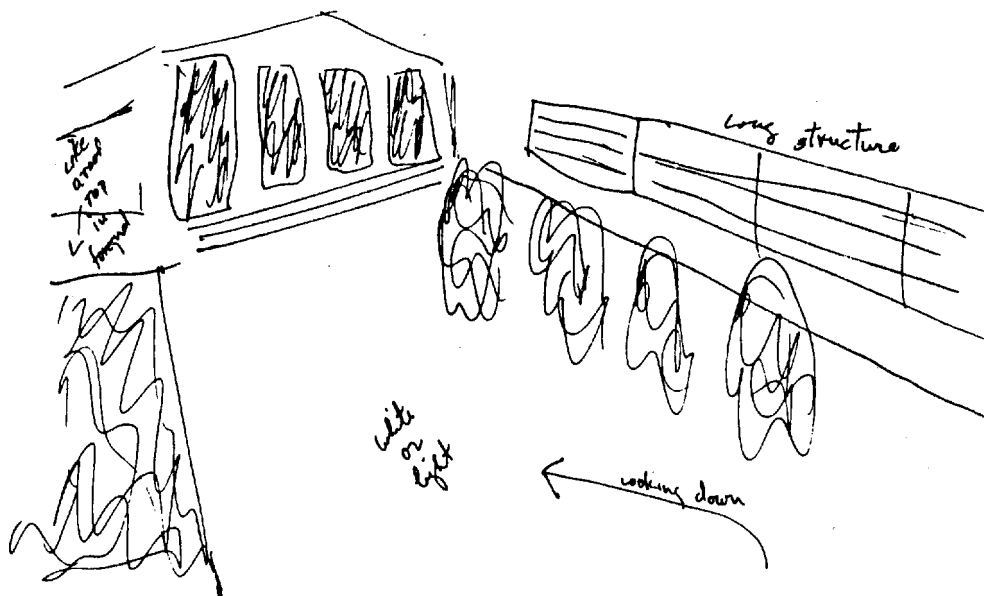
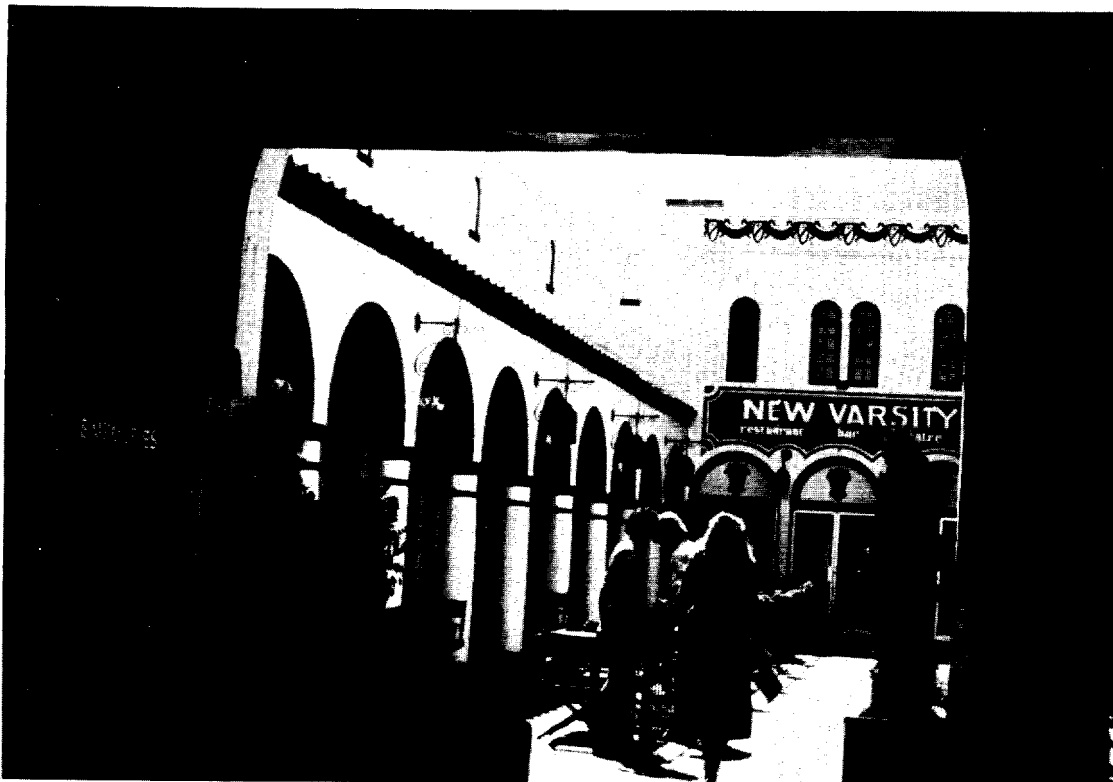

**UNCLASSIFIED**

FIGURE 11 VARSITY THEATRE ARCADE--TARGET, AND VIEWER 518 DRAWING (U)

**UNCLASSIFIED**

UNCLASSIFIED

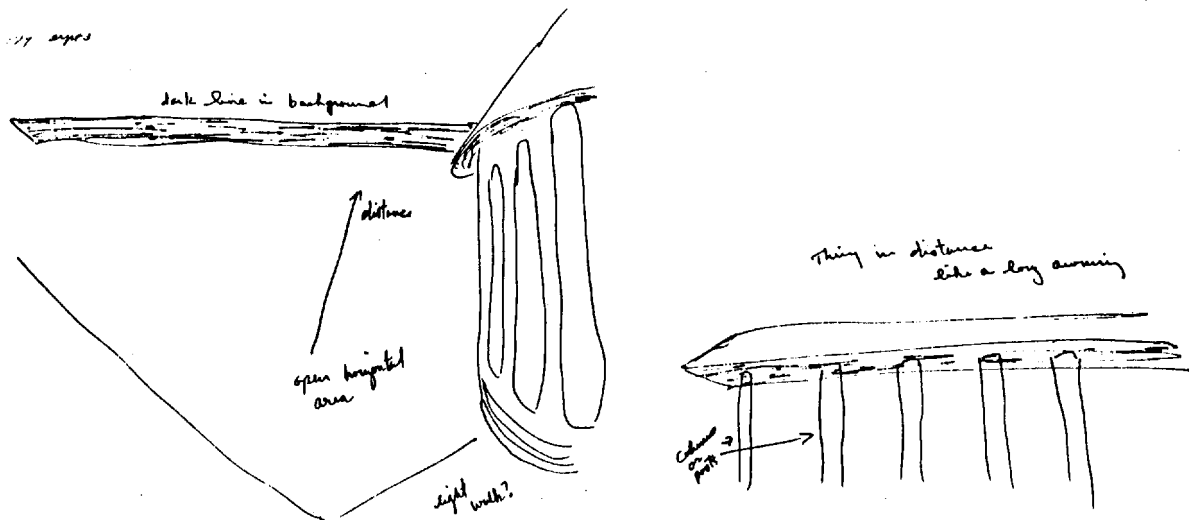

UNCLASSIFIED

FIGURE 12 VICTORIAN HOUSE--TARGET, AND VIEWER 518 DRAWING (U)

UNCLASSIFIED

UNCLASSIFIED



8/19/79 expert 3

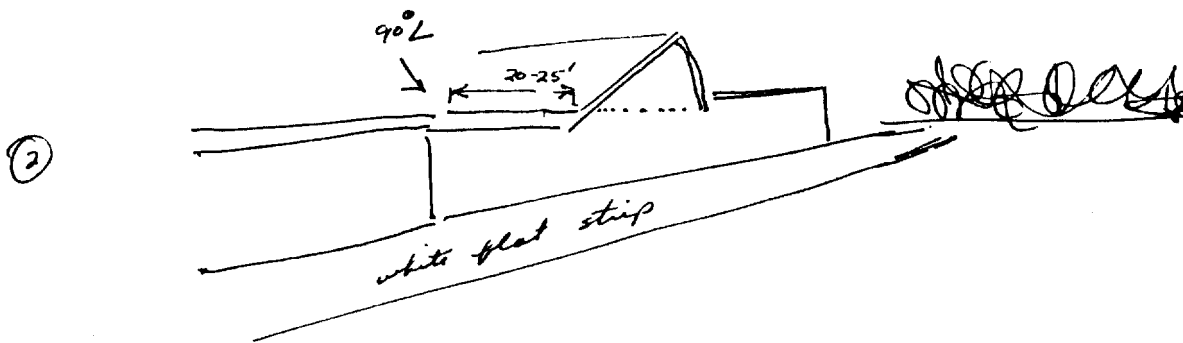

UNCLASSIFIED

FIGURE 13 GLASS SLIPPER MOTEL--TARGET, AND VIEWER 518 DRAWING (U)

UNCLASSIFIED

~~UNCLASSIFIED~~

(U)

The correspondences for the remaining three were of lesser quality, although still containing many correct elements. (The Accuracy Ratings for this series were 2, 5, 5, 2, 5, and 2, respectively, for a total of 21.) Note that neither slide series used an interviewer.

(U) With regard to the formal blind judging, in the rankings of the six pictorial responses alone the judge made an assignment of ranks (two 1st, three 2nd, one 5th place) that was significant at  $p < 0.04$ . However, the overall rankings combining verbal and pictorial responses together had a numerical deviation from chance expectation which yielded only  $p = 0.075$ . Although suggestive, this does not meet the criterion for statistical significance. In this series, therefore, pictorial information alone appears superior to pictorial plus verbal. In other words, the verbal information appeared to degrade the overall product.

(U) It appears from the data of these two series that remote viewers can perceive the contents of projected slides. Furthermore, they appear to describe the slides themselves, rather than the geographical locations corresponding to the slides. Finally, taking into account the brevity of the transcripts on the part of the viewer and the greater ease of analysis experienced by the judge, it appears that because of the more limited focus of content presented by a slide, a viewer and a judge have an easier time assessing data associated with the target in the slide case as compared with an outdoor target. Thus, in future screening/training studies the use of slides appears to be an efficient alternative to the use of physical locations as targets.

3. Comparison of Blind Judging and Accuracy Ratings for 35-mm Slides (U)

(U) After the completion of these two series, we undertook to make a further determination of the correlations between the Accuracy

~~UNCLASSIFIED~~



(U)

Ratings and the results obtained from blind judging. The two series received Accuracy Ratings of 22 and 21, respectively, and blind judging statistical significance measures of 0.04 and 0.08. Then, as a control, two researchers assigned new Accuracy Ratings for each of the twelve transcripts, this time rating transcripts in each series against the same numbered target from the other series. In effect, this is a measure of the Accuracy Rating that a transcript will receive when matched against a random target. A mean score of 13 was obtained for transcripts from Viewer No. 372 when matched against targets of Viewer 518. The mean score for the cross-matching of transcripts from Viewer 518 against targets from Viewer 372 was 9. The mean of these two scores is  $(9 + 13)/2 = 11$ , which is roughly half the average accuracy scores from the series when matched against the appropriate corresponding transcript/target pairs.

(U) This result is in good agreement with a similar analysis carried out two years ago in connection with a coast-to-coast remote viewing series. One viewer who took part in the series was to describe the location of a traveler in New York City on two different days. The transcripts and drawings were considered good matches for each day's target, although they contained incorrect as well as correct statements. In this early study, each transcript contained about twenty identifiable concepts. Each statement was given a numerical rating on a scale from 0 to 10. When the concepts were matched to the correct day's target, the mean score was 66%, whereas when they were matched against the other, noncorresponding day's target, the mean score was 33%. This previous analysis thus also yielded a two-to-one correspondence factor between remote viewing transcripts for corresponding and noncorresponding targets.

~~SECRET~~

B. Future Remote Viewing (FRV) (U)

(S) In the course of our remote viewing experiments we have occasionally been directed by clients to have subjects describe a target location or event as it would appear at some future time. We have also asked viewers to describe target locations that would not be chosen until after the end of their description. Our assessment and that of the cognizant clients is that the quality of these (admittedly few) future remote viewings is approximately comparable to that of the remote viewings carried out with real-time targets. It appears that if the FRV process can be developed further it would offer a new and stunning array of operational possibilities.

(U) In addition to our own experience with FRV in the laboratory, the principal remote viewing replications in the academic community, which have been carried out at Mundelein College in Chicago by Bisaha and Dunne, have all been of the FRV type, with the target selection following the viewer description, often by several hours. These were successful even when the viewers were in Chicago, and the outbound experimenter was in the Soviet Union.\*

(U) We recognize that there is no current physical explanation for future remote viewing, although theories have been put forward by physicists Feinberg and de Beauregard, among others. However, even in the absence of a good understanding, these phenomena appear to occur with some reliability, and therefore lend themselves to utilitarian purpose.

(U) In the past year, future remote viewing scans have been carried out using as targets both 35-mm slides and local Bay Area locations being

---

\* (U) J. Bisaha and B. Dunne, "Mind at Large," Institute of Electrical and Electronic Engineers Symposia on the Nature of Extrasensory Perception, C. T. Tart, H. E. Puthoff, and R. Targ, Eds. (Praeger, New York, N.Y., 1979).

~~SECRET~~

**UNCLASSIFIED**

(U)

visited by a target experimenter. In this section we present the results of this FRV study.

1. Viewer No. 468, RV and FRV of 35-mm Slides (U)

(U) As a first step in assessing the reliability of future remote viewing we carried out a series of eight slide trials with Viewer 468, who had produced several excellent responses in his phase-one series of real-time local Bay Area target remote viewings. Six of the eight trials were FRV trials, two were real-time.

(U) In the six FRV trials the viewer was asked to describe the contents of 35-mm slides, before each slide was randomly chosen for display. Immediately after his description of the slide, a random number generator was activated in the monitors' room in a separate building (trailer) to give a number between 1 and 60. The corresponding 35-mm slide was then projected in the monitors' room. After the monitors recorded the name and number of the chosen slide, they went to the viewer's location and escorted him to the monitors' location for feedback. The FRV series was blind judged and also judged on the basis of Accuracy Ratings by two analysts. All three ratings agreed that the data were suggestive, but not statistically significant. The blind judging found that the FRV series departed from chance expectation at the  $p = 0.1$  level, with two first place matches, one second, one third, one fifth, and one sixth. (A value of  $p = 0.05$  is required for formal statistical significance.) The Accuracy Ratings by the two analysts totaled 18 and 20 respectively, with four of the six trials rated by both analysts as 3 or higher, which is to say (from Table 2): "a mixture of correct and incorrect elements, but enough of the former to indicate that the viewer has made contact with the target."

**UNCLASSIFIED**

(U) A summary of the six FRV target slides and the viewer's responses is given in the following. The remote viewer's drawings are shown for the two first-place matches to indicate the quality required for successful blind matching.

- (1) (U) Windmill. The target is a large white windmill with four blades, mounted on top of a red A-frame tower. The viewer described an inverted V-shaped structure, associated with a circular object divided into quarters. He also had a sense of circular motion. His drawing is shown in Section IV-C [Figure 3(b)]. This was rated first place in blind judging; Accuracy Ratings by the two analysts were 4 and 3.
- (2) (U) Stanford Shopping Center. The target is the central mall of the Stanford Shopping Center. One view of this target location from an earlier series is given in Figure 10. However, the target slide for the present viewer was taken from a different direction. This viewer described and drew the repeated curved forms overhead and described it as "like a shopping plaza." (See Figure 14.) The blind judge awarded this description a first place match. Accuracy Ratings were 5 by both analysts.
- (3) (U) Alta Mesa Cemetery. The target slide features a large gravestone standing in the foreground, and several others visible in the middle distance. The viewer described a "dark vertical mass ... jagged, like a rock pile." This reminded him of a small mountain at Disneyland, appeared to lead to further erroneous analysis. Based on the drawings of a jagged rocky shape, the blind judge rated this response a second place match to the target slide, while Accuracy Ratings were 3 and 2.
- (4) (U) Merry-Go-Round. The Rinconada Park merry-go-round as an outdoor target has been described excellently by two viewers in past years. This viewer correctly identified the park-like atmosphere (correct), but placed much emphasis on the target being at a crossroads (incorrect). Finally, he said that a cylinder had emerged at the crossroads

UNCLASSIFIED

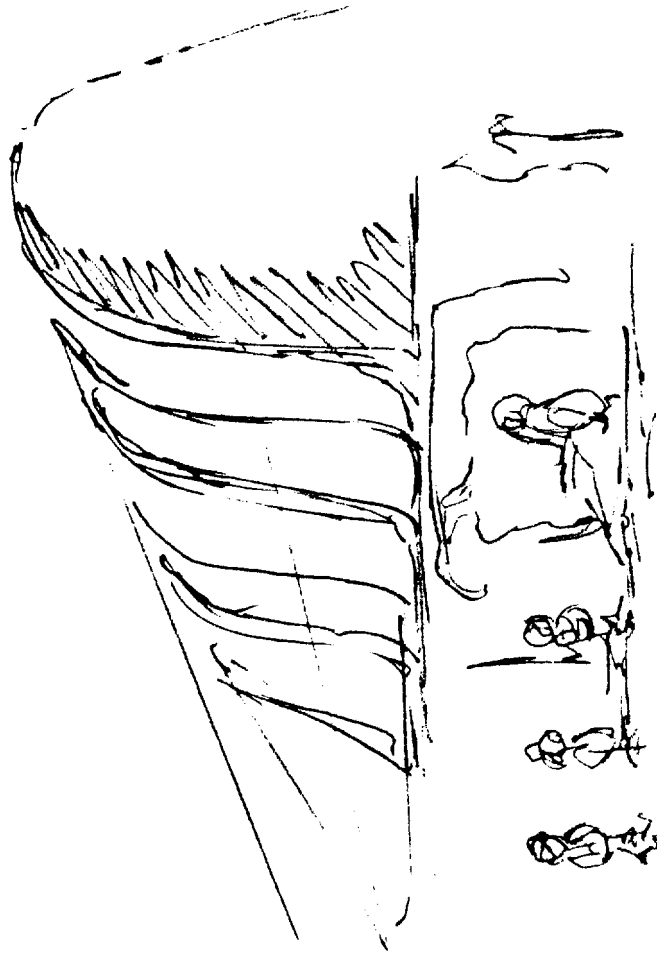

UNCLASSIFIED

FIGURE 14 STANFORD SHOPPING CENTER--TARGET, AND RESPONSE OF VIEWER No. 468 (U)

UNCLASSIFIED

~~UNCLASSIFIED~~

(U)

in the park, and he then made a formal drawing with a three-dimensional cylinder, shown rotating as the central object. The judge rated this a third place match. Accuracy Ratings were 3 and 4.

(5) (U) Padre Statue. This target is a very large plaster statue of a kneeling monk on a hill top, pointing into the distance. The viewer had a description of a park with a duck as the focus. The blind judge rated this fifth place for correspondence. Accuracy Ratings were 3 by both analysts.

(6) (U) Bridge in Burgess Park. This target is a wooden footbridge over a stream in a nearby park. The viewer's first impressions correctly portrayed a wooden framework pierced by metal, but he followed this first view with several pages of incorrect pictures, resulting in a sixth place match, and Accuracy Ratings of 2 and 1.

(U) Although this viewer's FRV data did not reach statistical significance in the blind judging, we find enough correspondences in the Accuracy Ratings to suggest that the viewer did make contact with the target material on some of the trials. In comparing the results of blind judging with those of the Accuracy Rating system, we note that statistical significance in the blind judging is a compound measure which includes consistency and reliability, as well as remote viewing per se. For example, in the following series, Viewer 292 provides two trials that were each given an Accuracy Rating = 5, but his overall blind judging results were nonsignificant and less than the present series, because of a lack of trial-to-trial consistency.

(U) The two real-time slide targets, a redwood grove and an underpass, were inserted in the FRV series (for comparison purposes) after the fourth FRV slide. They received Accuracy Ratings of 3 and 4 respectively, and were thus of similar quality as those in the FRV series.

~~UNCLASSIFIED~~

2. Viewer No. 292 RV and FRV of 35-mm Slides (U)

(U) We carried out twelve randomly intermixed future RV and real-time RV trials with this viewer. The targets were 35-mm slides displayed in another building as above. In this effort, we tried to deal with the fact that a viewer might feel anxious about FRV experiments in general. The previous viewer, in spite of his encouraging results, daily expressed concern about the impossibility in principle of the task. Therefore, in this series we had equal numbers of real-time and FRV trials randomly intermixed, so that the viewer would not know, at the time of the trial, which type of trial it was. The protocol from the viewer's point of view was exactly the same in both cases, in that he could not distinguish between the two conditions on the basis of the protocols. He would give a description of a target slide, and a few minutes later would be taken to see the slide. From the monitor's point of view the two situations differed in that during the FRV trials there was no slide to look at, since it would not be chosen until after the conclusion of the viewer's description. In the real-time trials, the slide was viewed by the monitors for the entire duration of the viewing/description period.

(U) The two groups of trials were rated for accuracy, independently by two analysts. The six real-time trials received summed Accuracy Ratings of 19 and 16 by the two analysts, while the FRV series was rated 16 and 15. Both series are therefore rated somewhat on the low side overall, with results of individual trials ranging from no evidence of contact with the target site to excellent.

(U) As in his initial Local Bay Area remote viewing series in Phase One, however, this viewer again turned in some of the highest rated and most accurate individual responses of any viewer in the Phase Two portion of the program. We discuss two of these which occurred in the FRV series. Both were very accurate descriptions of quite unusual targets,

(U)

receiving Accuracy Ratings of 5 by both analysts. (The other four responses in the FRV series received Accuracy Ratings of two or less.)

(U) In the first, the target was the slide of a showroom of a local Chevrolet automobile dealer. The viewer rendered a drawing (shown in Figure 15) and described the following scene before the selection of the target slide. "To the right of center there is something that reminds me of a tall minaret shape. Greater height than width. Somewhere there is a conical shape" ... "1-2-3-4-5, I don't know what it means, but I get two quick glimpses of a five pointed star. I don't know where to put it. The star reminds me of a sheriff's badge." In Figure 15 we see that a star is part of the showroom window display.

(U) The photographs for this series were taken several weeks before the start of this program. On visiting the target site, we were interested to note that the star was no longer part of the showroom decor, and had been removed before this trial. So in this case we have striking evidence that the viewer obtains his information from the target slide, rather than from the location.

(U) The second good result in the FRV series is the viewer's response to a schoolhouse target at a miniature golf course. The viewer's first words were "I have an instant awareness of what appears to be a conventional roof line, pointing into the scene from the left. It appears to have an overhang, but the confusing thing about it was that it appeared white and thick like it had 9 or 10 inches of snow on it." As shown in the photo in Figure 16, the overhang was white and thick. Later in the session he described a "blue canal with masonry walls, curving out of the picture." The color slide target shows a blue putting green leading up to the front of the little target building.



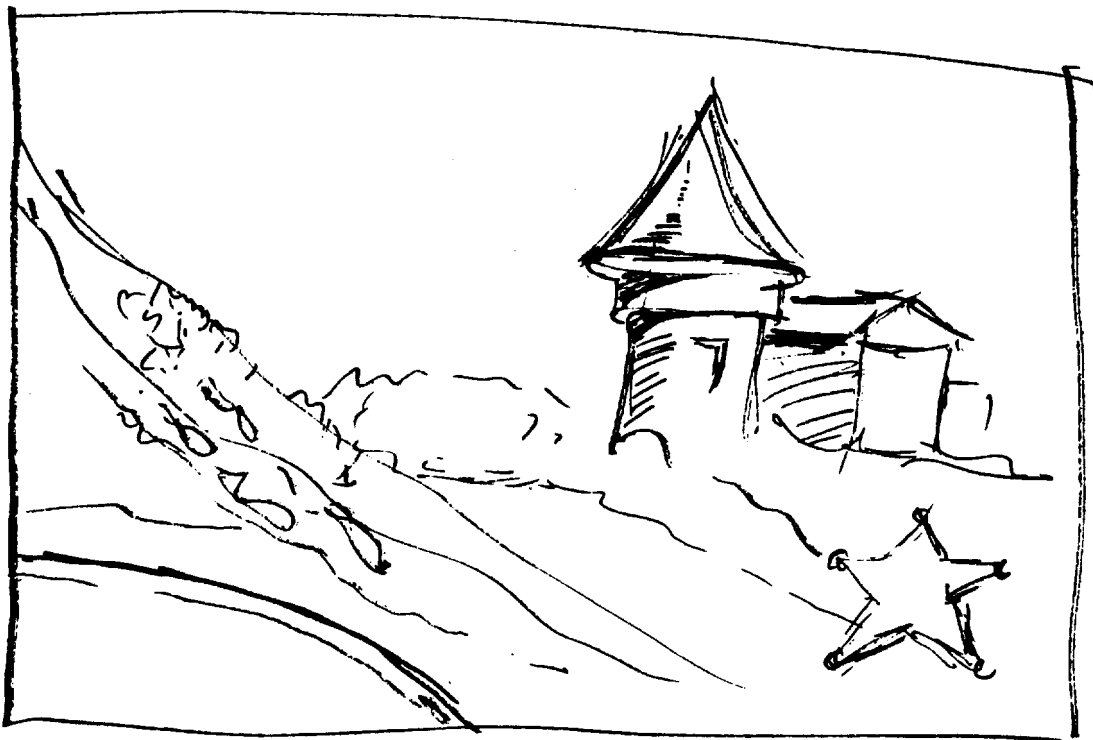

UNCLASSIFIED

FIGURE 15 TARGET SLIDE, AND VIEWER 292 RESPONSE FIFTEEN MINUTES BEFORE RANDOM SELECTION OF TARGET (U)

UNCLASSIFIED

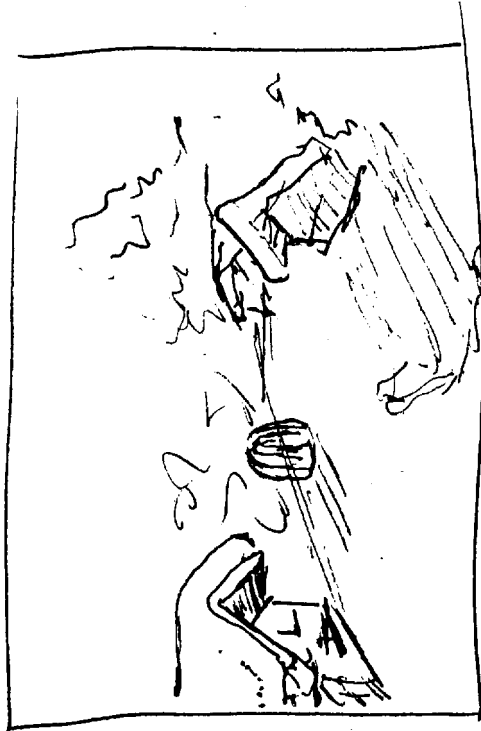
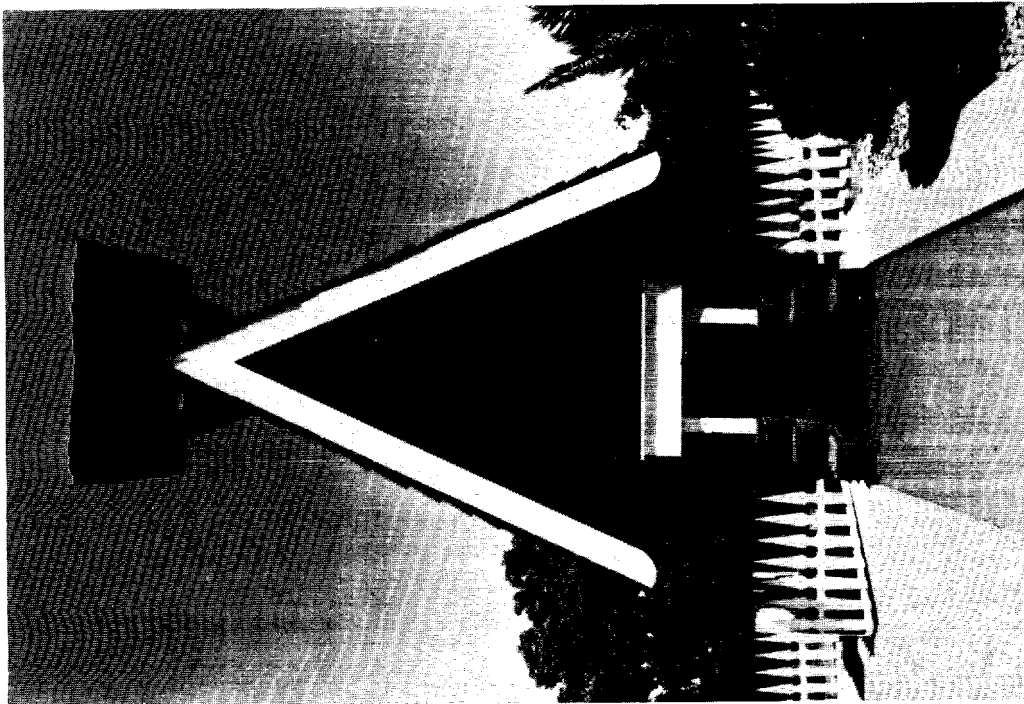

UNCLASSIFIED

FIGURE 16 TARGET SLIDE, AND VIEWER 272 RESPONSE FIFTEEN MINUTES BEFORE RANDOM SELECTION OF TARGET (U)

UNCLASSIFIED

**UNCLASSIFIED**

(U) We consider these two trials among the better examples of laboratory evidence for paranormal perception in this program, and it is interesting to note that they occurred in an FRV series.

3. Viewer No. 155, RV and FRV of 35-mm Slides (U)

(U) The protocol for this series of trials was the same as for the previous viewer. We carried out twelve trials, six trials each, of intermixed future and real-time remote viewing of 35-mm slides. This viewer's results received totaled Accuracy Ratings of 17 for the FRV trials, and 16 for the real-time remote viewing trials.

(U) The first three of the FRV trials yielded evidence of contact with the target, and were given Accuracy Ratings of 4, 5, and 4; the last three were given Accuracy Ratings of 2, 2, and 0.

(U) The first successful target was a pedestrian underpass, under a Southern Pacific Railroad station. The target slide shows a long, dark tunnel of square cross section, with a bright light at the far end. The viewer drew a receding perspective, and said (among other things), "I almost felt like I was in a long hallway looking at a bunch of lockers along the hall." "Almost like you would see in school, lined with lockers." Earlier, Viewer 468 had this target as one of two real-time control slides in the middle of his six FRV trials. He also described and drew the receding perspective, and announced rather critically in the session that, "this is the most underexposed slide I have ever seen" (correct), although at the time he was seeing it only remotely.

(U) A second successful FRV target for Viewer 155 was a Methodist Church. The viewer correctly identified the target as a church, drew its courtyard in some detail, and also made a drawing of the facade of the church with many correct elements. This response was given an Accuracy Rating of 5. In the third successful FRV trial, Rinconada swimming

**UNCLASSIFIED**

**UNCLASSIFIED**

(U)

pool, the viewer described a body of water enclosed in a rectangular frame, which he drew very accurately. He also described accurately the reflections seen in the water. This was the only water target in the series, and also the only session in which he mentioned water. This target received an Accuracy Rating of 4. The balance of the trials in the series yielded data containing some correct elements, but not sufficient to suggest results beyond chance expectation.

4. Viewer No. 155, FRV of Local Target Sites (U)

(U) An additional series of FRV trials was carried out with Viewer No. 155 in an effort to determine whether any differences would be found between trials with target slides, and trials involving actual Local Bay Area target locations.

(U) Six trials were conducted at a rate of two per day for three days, one each morning and afternoon. The viewer was asked to describe his mental pictures and feelings with respect to the target location that would be randomly selected at the conclusion of that trial. That is, the viewer would be asked to describe the site as he would see it one hour later when he would be there with the interviewer. Immediately after each trial, the viewer and the interviewer would leave the laboratory, access the target pool by random number generator, and then proceed to the chosen target site. A number of interesting factors surfaced during these trials, making this series of greater interest than might be indicated by the overall Accuracy Rating of 19 assigned in the combined ratings.

(U) In Trial No. 1 in this series, the viewer began his narrative description with the words, "I am getting squares within squares within squares." He then made the drawing shown in Figure 5(b). As indicated in an earlier discussion (Section IV-C), these words describing the target were the same as those used six years earlier by another subject describing

**UNCLASSIFIED**

**UNCLASSIFIED**

(U)

a target. Since in the present case the target was not yet chosen, it was with much anticipation that interviewer and remote viewer left the session room at the end of the session, went to the project office, and randomly generated by RNG a target number to determine which of the sixty target locations would actually be visited. The number was generated and the target envelope drawn. It was found to be the pedestrian overpass, just as in the 1973 trial which elicited the same description. (At the time of the random generation of the target number, the interviewer did not know the number of the pedestrian overpass target.) The Accuracy Rating assigned to the viewer's response was 4. (In addition to his correct impressions, erroneous analysis and interpretation of his data come into play.)

(U) Trial 2 was a Hyatt House Hotel. The viewer drew and described a receding double column of rectangular objects of differing heights, going off into the distance. He also drew, as his main perception of the target, a perspective showing a narrow sidewalk that one looks across to see a narrow roadway, and then another narrow walkway. Behind this are divided buildings or a divided wall (all his terminology). When we arrived at the site we found little correspondence to the viewer's description of the place, although there is a long row of statues running from the street to the hotel, which are suggestive of his first drawing.

(U) Since we arrived a few minutes early, we went into the lobby of the hotel, although the "target" was the outside of the building. After we looked around the lobby the monitor noted that the agreed-upon target time was almost upon them, when the viewer was to be outside at the target. Therefore, we left the hotel lobby at the exact target time, and noticed that we were facing a scene greatly resembling the drawing generated during the session. As we stood on the steps of the hotel

**UNCLASSIFIED**

(U)

looking out, we were standing on a narrow sidewalk, looking across a narrow driveway, to another narrow walkway to the four wide supporting columns that hold up the large overhang covering the driveway and the entry to the hotel. The Accuracy Rating was 4.

(U) Trial 3 was a Menlo Park brickyard. The viewer saw "lots of corners and angles ... two and three dimensional shapes." Then he described a "wall with columns sticking out of it," and later drew a curvy road going off to the right. All these elements can be found within the rich material of the brickyard. In particular, if one stands facing the wall with the columns sticking out of it, there is in fact a curvy road on the right. The Accuracy Rating was again 4.

(U) Target 4 was a local tennis court. The viewer's descriptions was primarily of a windmill and a metal bell-shaped object, both of which bear no obvious resemblance to elements of the target site. He did, however, describe and draw a latticework arrangement that was suggestive of a tennis net, and he described the area as recreational or a playground. Accuracy Rating was 2.

(U) Target 5 was a large bubble-shaped air-inflated building. The description consisted mainly of arches and pillars as in a colonnade, overlaid with images of San Francisco, which are not particularly apropos. His drawings of receding curves and arches reflect somewhat the main elements of the target site, but altogether an Accuracy Rating of 2 characterizes the result as not being beyond chance expectation.

(U) The sixth and final target was a large commercial salt pile in Redwood City. The target is a salt storage yard of Leslie Salt Company, on the edge of San Francisco Bay. The salt pile is a hundred feet long and perhaps fifty feet high, and it shines brilliantly in the sun. The viewer did not see or describe anything at all resembling the

**UNCLASSIFIED**

(U)

target. Instead, he described a wooden cylinder sticking out of the water, so that its bottom could not be seen. He described and drew on top of the cylinder a conical metal cap or cover. He also said that the main item in the vicinity was a redwood building with exposed timbers and a large, peaked overhang.

(U) The difficulty with judging this trial, and, in fact, the series as a whole, derives from the following: While standing at the salt pile for the feedback portion of the trial, the viewer can look a hundred yards or so across the estuary that separates the salt refinery from the Redwood City Marina, and observe that his description matches the latter perfectly. For across this narrow body of water was a large restaurant made of dark redwood just as described in the transcript, and along the dockside was a row of posts sticking up out of the water, each with a blue conical sheet-metal cap to serve as an anti-seagull device. An accuracy rater at the restaurant would certainly give the transcript an Accuracy Rating of 5 for its correspondences, but, since that did not happen to be the intended target, the transcript receives an Accuracy Rating of 3.

(U) Because of the above difficulties inherent in FRV site definition we did not think it worthwhile to subject this otherwise quite interesting series to blind judging. It is our impression, however, that this series and the other FRV slide series carried out as part of this program does offer some evidence for the existence of FRV functioning, with individual trials often at an accuracy comparable to real-time remote viewing.

**UNCLASSIFIED**

~~UNCLASSIFIED~~

C. Extended Remote Viewing (ERV), Viewer No. 518 (U)

1. Background (U)

(U) One of the program remote viewers (No. 518) stated that over the past few years he had on occasion experienced spontaneous extended remote viewing (ERV),\* usually associated with rest or sleep periods. Subjectively, these ERV experiences appeared to be of unusual intensity and clarity; however, the situation and/or content of these experiences did not lend themselves to independent objective verification. Therefore, Remote Viewer 518 requested that some time be devoted to investigating the phenomenon, with the goal of determining whether the content of such ERV experiences was verifiable and, further, of superior quality to that obtained in the ordinary RV protocol.

2. Pilot Effort (U)

(U) An initial single-trial pilot effort in ERV was carried out during Remote Viewer 518's first day at SRI. In this trial there was some evidence that information obtained in the ERV state was veridical. Therefore, it was decided that upon his return a formal series of trials would be undertaken.

3. Formal Series (Six Trials) (U)

(U) The formal series of trials consisted of six targeting periods of approximately three hours each. During each of these trials the remote viewer was closeted in a third-floor laboratory of the Radio Physics Laboratory in the SRI complex and asked to render drawings and

\* (U) ERV (extended remote viewing) is here defined as an exercise in remote viewing for an extended period of time, generally lasting for more than an hour. Furthermore, an effort is made to maximize the subjective sense of awareness of the target site while minimizing the subjective sense of awareness of the remote viewer's physical surroundings.

~~UNCLASSIFIED~~



~~SECRET~~

(U)

describe into a tape recorder his impressions of a target object. Each session was terminated either by the monitor who indicated that the (approximate) three-hour period was up, or by the remote viewer himself at a somewhat earlier time. The remote viewer was then taken to the target location for feedback.

(S) For the first four trials the targets were chosen by the SSO of an SRI SI/TK facility on the first floor of the Radio Physics Laboratory, and placed on display on a conference room table in that facility. (The SSO is not otherwise associated with the SRI psycho-energetics program.) As part of the first trial the remote viewer was asked to describe the facility as well as the target object; for the remaining three trials he was asked to describe the target object only.

(U) Before the fifth trial, it was decided by the remote viewer and monitor that the target location for the remaining two trials should be changed so as to avoid analytical overlay problems associated with target-site familiarity. The site chosen by the monitor was the roof of the Radio Physics Laboratory building, directly above the ceiling of the room in which the remote viewer was located.

(U) Trial 1. The target object for Trial 1 was a copper ewer (pitcher) placed on a dark brown wood-grained table (see Figure 17). The remote viewer sketched an object that evolved into a table-lamp base, finally topped by a lampshade.

(S) The description of the facility rendered by the remote viewer had many matching elements, although it appears that the remote viewer combined the two primary rooms into one; because of this, however, the description is ambiguous and cannot be taken as evidential.

(U) Trial 2. The target object for Trial 2 was a metal food mill with red handle shown in Figure 18. In response the remote viewer

~~SECRET~~

UNCLASSIFIED

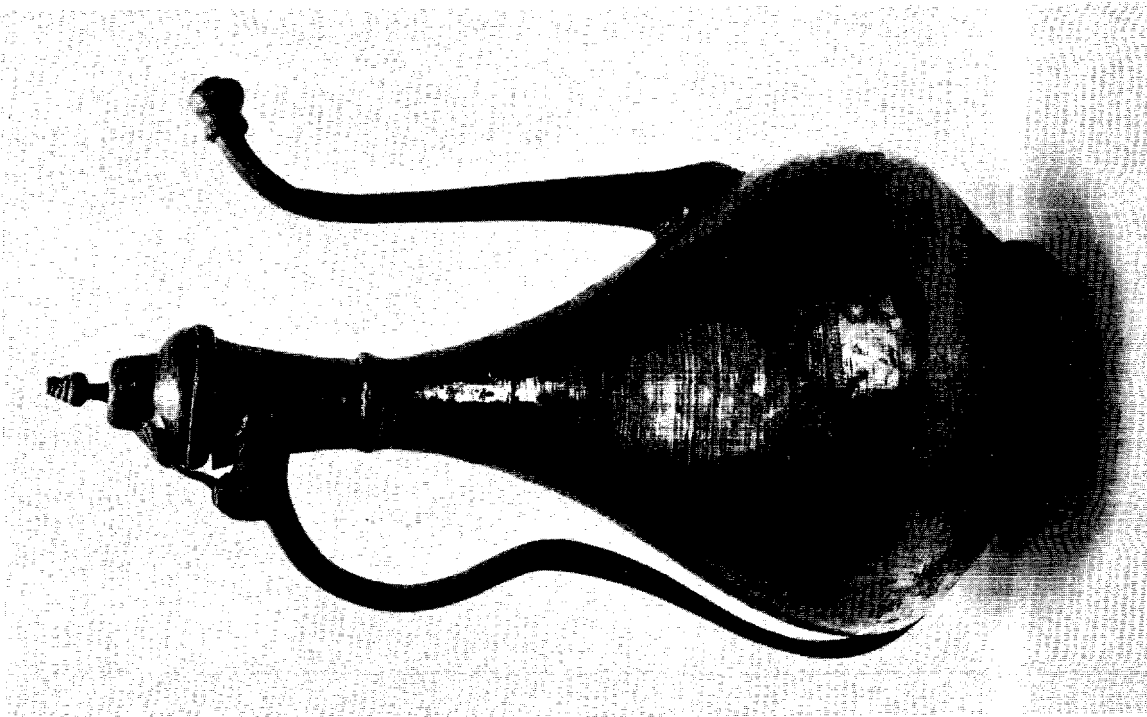
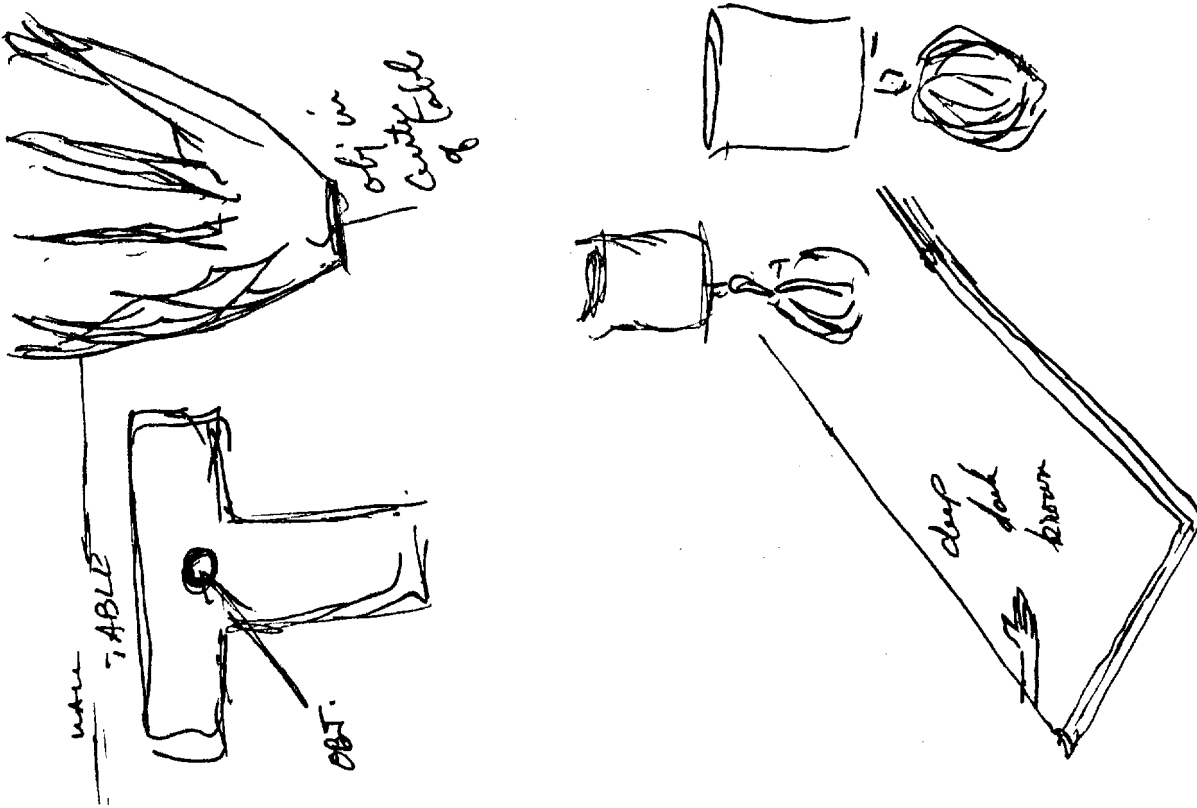

UNCLASSIFIED

FIGURE 17 COPPER PITCHER, AND VIEWER No. 518 ERV RESPONSE (U)

UNCLASSIFIED

UNCLASSIFIED

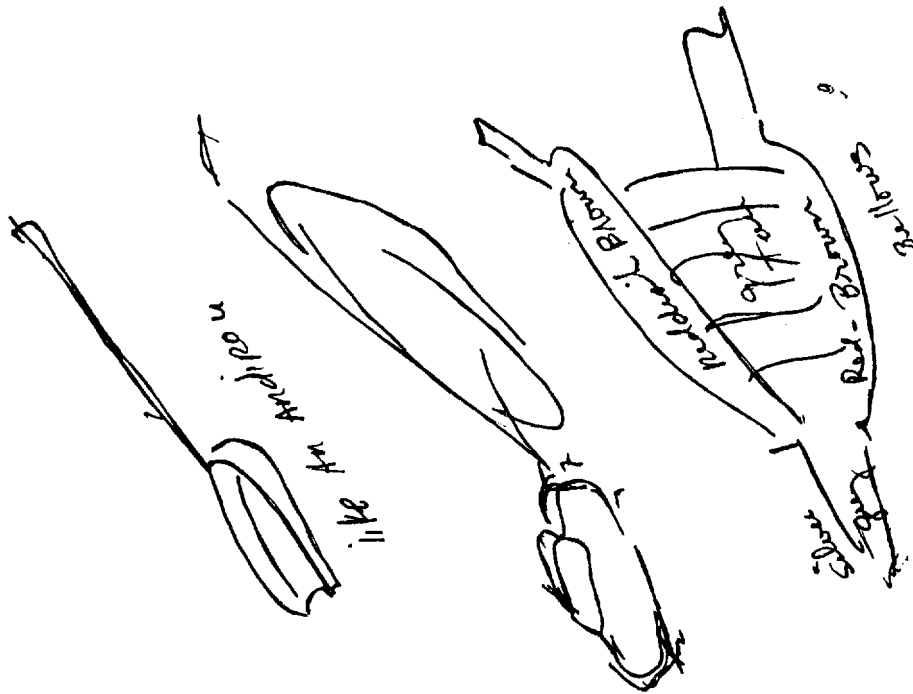

UNCLASSIFIED

FIGURE 18 FOOD MILL TARGET, AND VIEWER No. 518 ERV RESPONSE (U)

UNCLASSIFIED

~~SECRET~~

(U)

sketched a silver-grey object with a handle on it that looked first like a fireplace scoop (most correct), and then evolved into a bellows.

(U) Trial 3. The target for Trial 3 was a straw hat with curled up brim and dimpled top (Figure 19). The remote viewer's response is shown in the same figure.

(U) Trial 4. Target 4 was a photographic tripod (Figure 20). The remote viewer's response, shown in the same figure, consisted essentially of a silver teapot-like object sitting on a tripod.

(S) Trial 5. Following the first four trials, the monitor and remote viewer agreed that the target location for the remaining two trials should be elsewhere than the now-familiar SI/TK facility. Several alternative locations were discussed, with the final decision to be made by the monitor. The monitor chose the roof of the Radio Physics Laboratory and intended to place a target there. Due to an error in timing, the remote viewer began the fifth session without having met with the monitor to learn which of the discussed alternative locations was to be used. In the absence of this communication there was no overtly agreed-upon target location and no special target was set up. Nonetheless, we observe post hoc that the remote viewer described an outside, brightly lit gravel-based area, and provided a response that resembled the intended roof target area (see Figure 21). Because of the ambiguity of target location and absence of a specific intended target, however, this trial is set aside and not included in the package of results to be blind judged.

(U) Trial 6. The target chosen for the final trial was a world globe (Figure 22). In response the remote viewer drew a sphere mounted on a stand, but did not cognize the map aspect. He also shows the roof line, but this cannot be taken as evidential since it was known that the target was to be on the roof

~~SECRET~~

UNCLASSIFIED

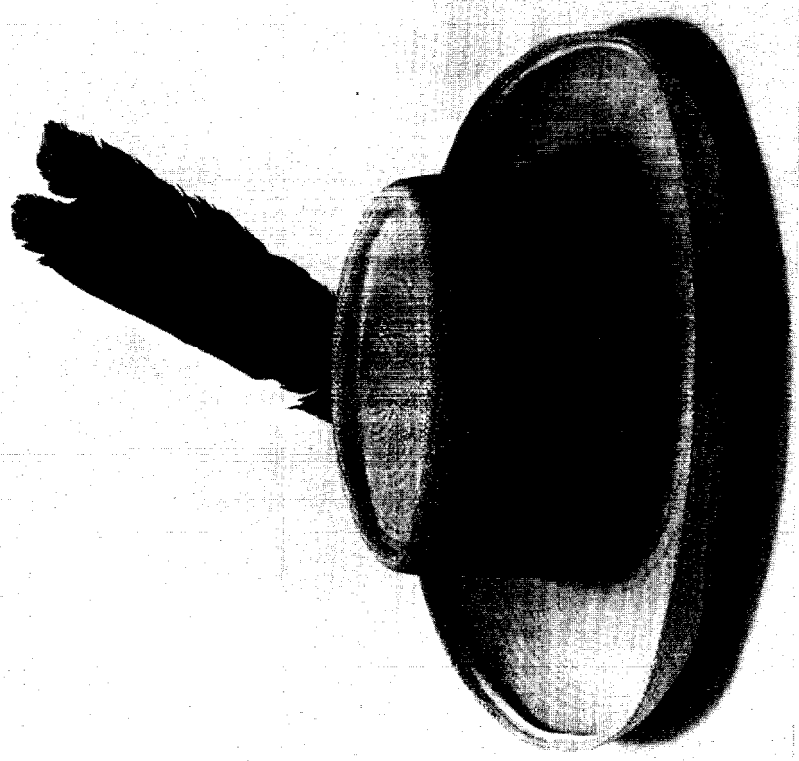
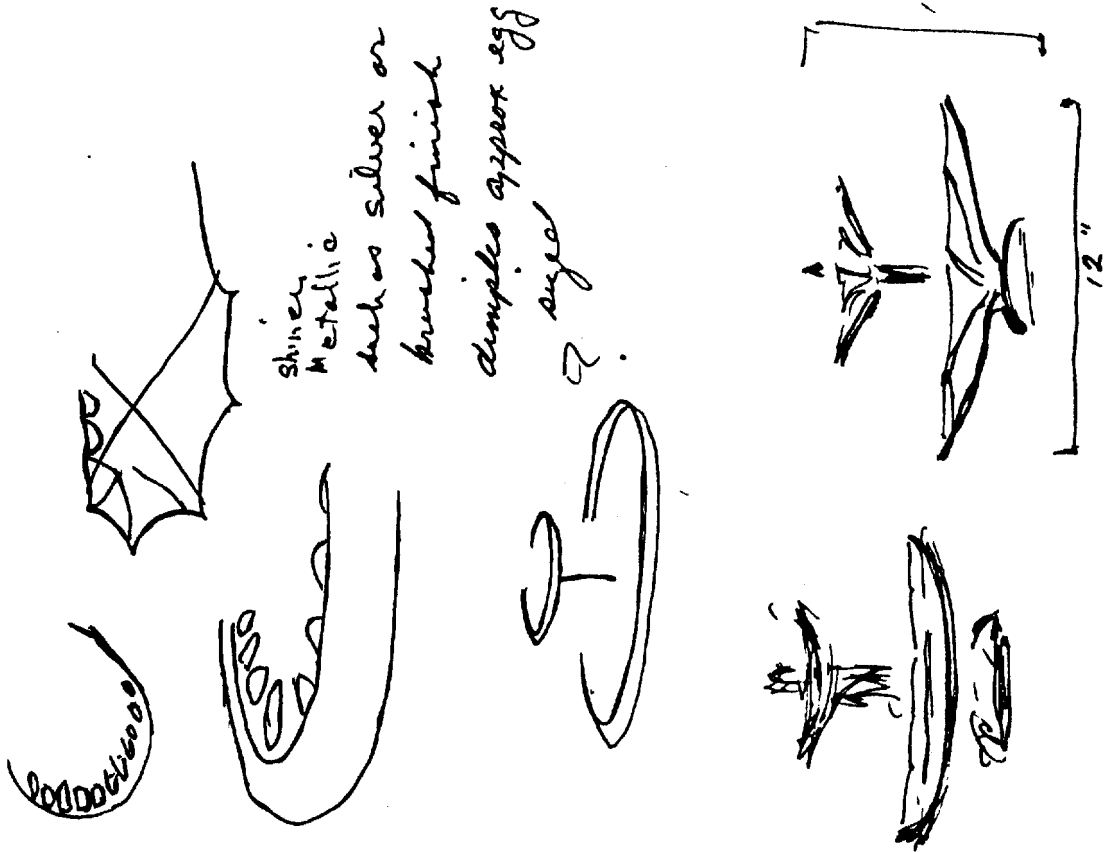

UNCLASSIFIED

FIGURE 19 STRAW HAT TARGET, AND VIEWER No. 518 ERV RESPONSE (U)

UNCLASSIFIED

UNCLASSIFIED

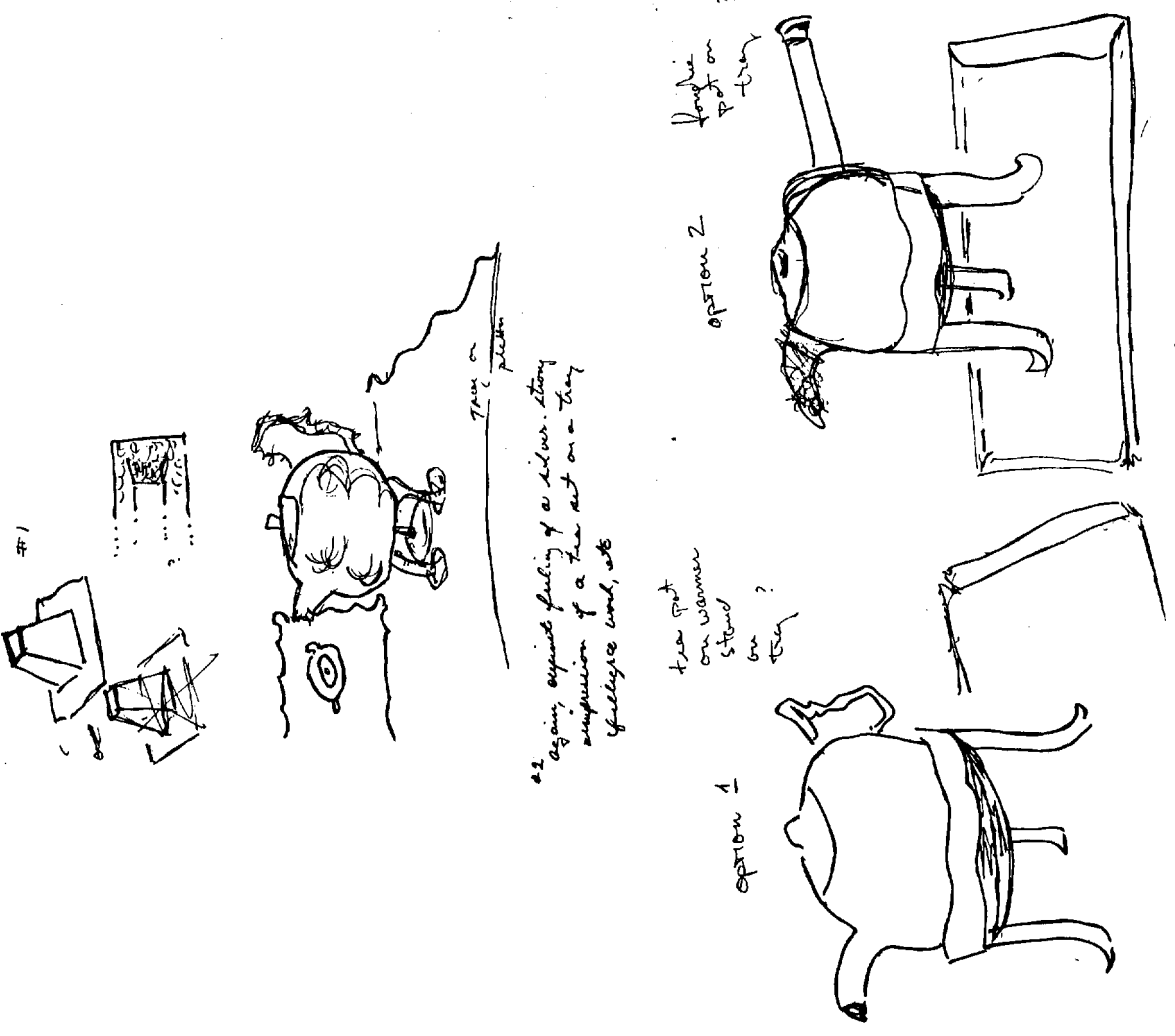

UNCLASSIFIED

FIGURE 20 TRIPOD TARGET, AND VIEWER No. 518 ERV RESPONSE (U)

UNCLASSIFIED

UNCLASSIFIED

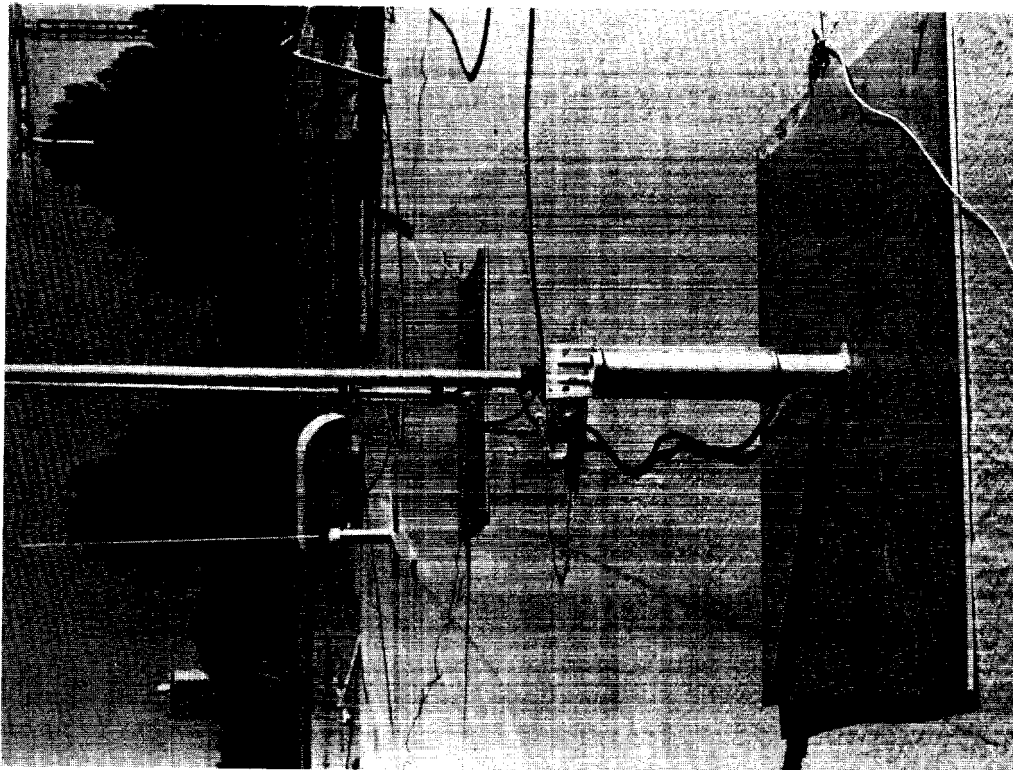
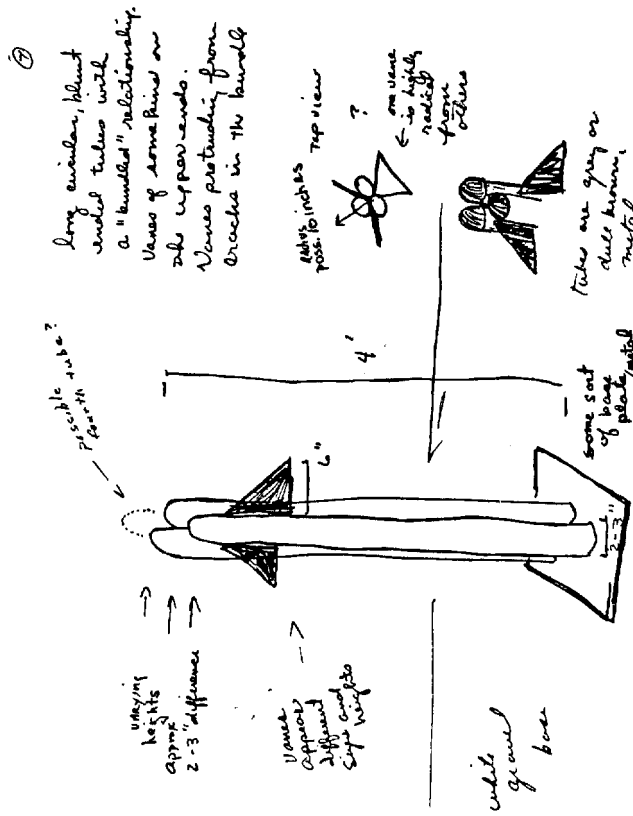

UNCLASSIFIED

FIGURE 21 ANTENNA, AND VIEWER No. 518 ERV RESPONSE (U)

UNCLASSIFIED

UNCLASSIFIED

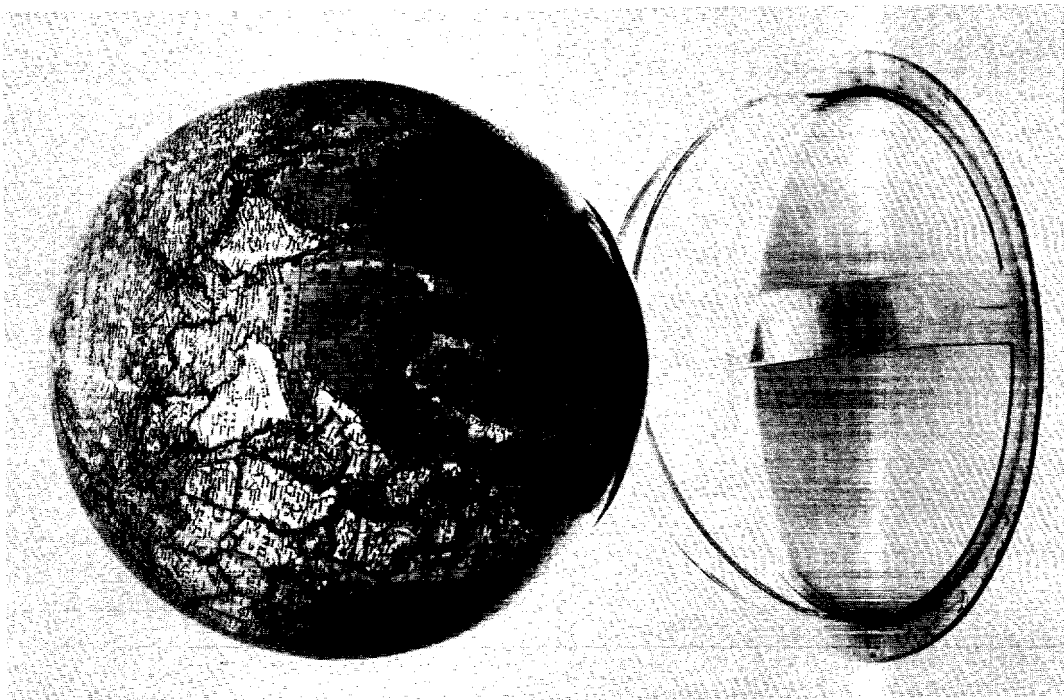
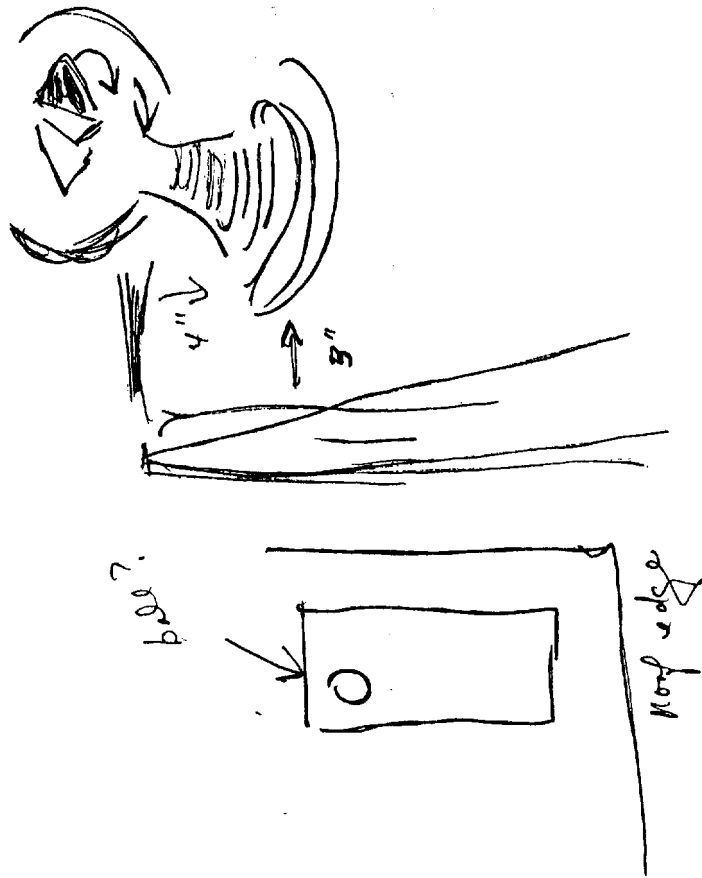

UNCLASSIFIED

FIGURE 22 GLOBE TARGET, AND VIEWER No. 518 ERV RESPONSE (U)

UNCLASSIFIED



UNCLASSIFIED

4. Discussion (U)

(U) For an assessment as to the quality of remote viewing obtained in the ERV series, the results were submitted to two analysts for blind judging. The judging packet submitted to the analysts consisted of the remote viewer drawings, and target photographs, each in their own random order different from the order of target usage. The analysts were instructed to blind rank order, on a scale of 1 to 5 (best to worst match), each of the five drawing packets against each of the five target photographs. (Target number 5 was omitted as described above.)

(U) One analyst obtained three direct matches, one second-place match, and one fourth-place match; the other obtained one direct match, three second-place matches and one fourth-place match. The difference between the two was a pair of responses that were essentially indistinguishable with regard to a particular pair of targets (food mill and hat). The matrices were analyzed using the direct-count-of-permutations method-discussed earlier. The results of one of the two judges reached statistical significance at the  $p = 0.05$  level.

(U) With regard to a comparison between ERV and the ordinary RV process, the data obtained are roughly of the same quality as those of ordinary RV.\* There was therefore no apparent advantage in committing the greater time period required for the ERV process. By report of the RVer, however, the subjectively more intense ERV state was never fully achieved in this series, and therefore no definitive comparison between RV and ERV is possible at this point.

\* (U) See, e.g., the technology series in H. Puthoff and R. Targ, "A Perceptual Channel for Information Transfer Over Kilometer Distances," Proc. IEEE 64, pp. 329-354 (March 1976).

UNCLASSIFIED

TARGETS  
FIGURE 1  
SIMILAR  
(CROSSING)

11. when  
said is  
revised

UNCLASSIFIED

D. Remote Viewing of Alphabet Letters (U)

(U) The purpose of this study was to determine whether an isolated remote viewer could learn to discriminate between and identify alphabet letters. The participant, Viewer 372, was located in a third-floor laboratory of the Radio Physics Building at SRI, while the monitor and the target materials were in an office trailer in a nearby parking lot (as in the slide series).

(U) The protocol in all twelve trials in this series was for the viewer to identify a randomly chosen three-letter word exposed to view in the target room. The targets used in this series were red block letters eight inches high, cemented to white cardboard. The three letters making up each word were placed on the chalk tray of the target room blackboard.

(U) Twelve trials were carried out. A satisfactory protocol was not developed until the third trial, so the first two must be considered exploratory. In Trial 1, the target word was randomly chosen from a group of ten previously prepared words placed in opaque envelopes. In all other trials the target word was chosen by random entry into a 1700-page college dictionary (selecting the first three-letter word on the page) using a Texas Instruments SR-51 random number generator. In Trials 1 and 2, the viewer was given feedback after each letter. In both of these trials he failed to name the first letter, but after being told the first letter G for GUN and V for VAT, he was able to confidently and correctly name the following two letters in quick succession. In Trials 3 through 12, feedback was given only after all three letters were named, to counteract analysis strategies on the part of the viewer.

(U) The letters were displayed one at a time, and the viewer would give his impressions of each in turn. After each description, that letter would be removed, and the viewer would be informed that the next letter

UNCLASSIFIED

*viewer vs. Print*  
*Actual*  
*viewer, NAME*

**UNCLASSIFIED**

(U)

was in place. Except for Trial 5, the letters were always presented in their order of occurrence in the word. (In Trial 5 it had been decided in advance to display the letters in random order, to discourage end-letter guessing. This turned out to be unsatisfactory, however, apparently producing confusion for the viewer, who named all three letters correctly, but had them in the wrong order. He then could not think of a word, and changed two of the letters.)

(U) Of the nine 3-letter words presented in a consistent manner (3, 4, 6-12), the viewer was correct in 6 of his letter assignments (i.e., of the 27 letters presented, 6 were identified), a significant departure from chance expectation. This pilot result was therefore encouraging.

E. Coordinate Remote Viewing (CRV) with Immediate Feedback (U)

(U) Of special interest for operational applications is a particular form of RV known as coordinate remote viewing (CRV). CRV is a procedure whereby the RVer accesses the target location on the basis of an abstract locator such as geographical coordinates. As inexplicable as such a phenomenon might seem, we appeal simply to pragmatism, in that it appears to work.

(U) It has been shown that good results can be obtained even with the use of special arbitrarily-constructed coordinate systems; \* the CRV phenomenon thus appears to provide yet another example of "goal orientation" in psychoenergetic phenomena, rather than being particularly related to coordinate systems per se.

---

\* (U) R. Targ, H. Puthoff, B. Humphrey, and C. Tart, "Investigations of Target Acquisition," Research in Parapsychology 1979, Scarecrow Press, Metuchen, N.J. (in press).

**UNCLASSIFIED**

~~SECRET~~

(S) An orientation program for CRV has been designed at SRI, and is being applied with success with RVer inexperienced in CRV. The details are as follows.

(U) A target pool of more than 100 geographical sites from around the globe has been prepared and is being continually expanded. The locations are chosen to embody some particular well-defined characteristic (e.g., mountains, oceans, deserts, lakes, cities, islands, rivers). The coordinates of these locations, obtained from standard reference atlases,\* are each written on one side of a 3-by-5-inch file card, on the other side of which is a descriptor (e.g., Mt. Hekla volcano, Iceland), along with an atlas reference. The cards are then placed in envelopes, coordinates facing the back, and randomized.

*unlettered  
page 102*

(U) The CRV orientation procedure is as follows:

- (1) (S) RVer and facilitator seat themselves at opposite ends of a table in a special environment,<sup>†</sup> the former with a supply of paper and a pen, the latter with target envelopes (contents unknown) and the reference atlases.
- (2) (S) The CRVer is instructed that the facilitator will begin the CRV process by selecting an envelope and reading aloud the target coordinates. The CRVer is to note down on paper any immediate impressions (which he may also express aloud) and then, rather than embellishing on his first impressions, to ask for the coordinates to be read aloud again so that the original process may be repeated, etc., until a coherent picture of the site emerges.

---

\* (U) The Times Atlas of the World, Houghton Mifflin Co., Boston, 1971.  
People's Republic of China Atlas, U.S. Government Printing Office, 1971.

† (U) The RV environment has been optimized during testing on another program to be quiet, dimly lit, and to provide a relatively homogeneous monochrome visual field, free of strong features and peripheral clutter.

~~SECRET~~

~~SECRET~~

- (3) (S) Following these instructions, the facilitator selects an envelope at random, opens it from the rear so as to be exposed to the coordinates only, and then begins the process described above.
- (4) (S) After one or more repetitions of the coordinates (each followed by a CRV response) leads to a recognizable target characteristic, the card is turned over by the facilitator, and the atlas consulted (if necessary) in order to give feedback. A line is drawn on the CRVer's data sheet to separate the data thus generated from further data, since up to this point the data were generated in a double-blind protocol and can be objectively evaluated later as a test of target acquisition.
- (5) (S) Having terminated the target acquisition "test" phase, feedback can now be given and/or further data solicited. The feedback given at this point is non-negative, ranging from "that's the target," through "near the target," to "you are at another target" (giving the CRVer the benefit of the doubt). The facilitator then has the option of terminating the viewing, asking for more detail ("there's something ten miles north that should be visible") or restarting the process when the viewer's original description did not correspond to the target site. In the latter case the facilitator can, of course, guide or cue the CRVer into a correct response; (a) this is acceptable in the nontest part of the sequence, (b) this can be checked for by asking for detail in the surrounding region, and (c) this provides an opportunity to investigate whether such cueing procedures can be useful in operationally oriented applications (e.g., guiding the CRVer onto the target site with cues "a," "b," ... "f," and then asking for "g").

(S) RVer 518 was exposed to this protocol, a few targets per session, over a several-day period, resulting in a data pool of 26 CRV target viewings. They were: Salt Lake Desert, Utah; Lake Erie; Chicago; Mono Lake; Aruba Island; Lake Okeechobee; Yount's Peak, Wyoming; Pitcairn Island; Pike's Peak; Los Angeles; Atlantic Ocean; Rio de Janeiro; Kansas plains, St. Peter and Paul Islands; Randall Dam, South Dakota;

~~SECRET~~

~~SECRET~~

(S)

Lake Titicaca; Cape May; Niagara Falls; Munich; Amazon River; Midwestern plains; Venezuelan Peninsula; Sierra Blanca Mountain; Oregon Desert; Panama Canal; Puerto Rico.

(S) Following the first pilot session of five, in which essentially immediate feedback was given, the remaining twenty-one were carried out with delayed feedback and thus provided material that could be assessed objectively. Categorizing the targets into five groups (mountains, flats, water, cities, islands/peninsulas), the target/response matrix is as shown in Table 4. The probability of such an alignment occurring by chance alone can be calculated by the direct-count-of-permutations method discussed earlier, and leads to  $p = 0.0083$ . The distribution of responses is therefore statistically significant. Furthermore, beyond simple statistics, certain individual responses were exceptionally accurate during the acquisition "test" phase. In the final trial in this series, for example, when the target coordinates were for Guayama in Puerto Rico, the viewer described a "fishing village on the southeast coast of a boat-shaped island," which is an entirely correct description of the locale at the target coordinates. He then drew an island, resembling Puerto Rico in both shape and orientation. A few orientation sessions were carried out with Viewers 155 and 292, with similar results.

(U) The above procedure is the first stage of a multi-stage training procedure developed on another program. The methodology centers around use of a specially-designed acoustic-tiled featureless room with homogeneous coloring to minimize environmental overlay; adoption of a uniform, limited monitor behavior role to minimize monitor overlay; and the use of a strictly specified CRV procedure involving repeated coordinate presentation and quick-reaction response--a procedure designed to minimize "imaginative" overlays. The effectiveness of this procedure is in the process of being

~~SECRET~~

~~SECRET~~

Table 4

(S) DISTRIBUTION OF CRV TARGET/RESPONSE MATCHINGS (U)

Targets	Transcripts				
	Mountains	Flats	Water	Cities	Islands/ Peninsulas
Mountains	3	0	0	0	0
Flats	0	1	1	1	0
Water	0	0	6	0	0
Cities	0	0	0	2	1
Islands/Peninsulas	1	0	0	0	5

(U)

confirmed with a number of remote viewers in another program, and the results to date indicate that a significant step forward in accuracy and reliability has been made.

~~SECRET~~

~~SECRET~~

## VI CONCLUSIONS AND RECOMMENDATIONS (U)

(S) In this report we have presented the results and assessments of a one-year program for the optimization of remote viewing with client-selected individuals. To meet the objectives of the program we have familiarized these individuals with the SRI RV protocol; pursued the development of enhanced levels of RV ability through exposure to several different orientation/training strategies, and established screening tests and procedures for enlarging the population from which such individuals are selected.

(S) Our principal observation in working with the six client volunteers is that we have found considerable evidence for remote viewing functioning among them. In the basic local-site RV-familiarization task (Phase-One study), four of the six participants produces results that were individually statistically significant ( $p < 0.05$ ),\* rendering the series strongly significant as a whole ( $p = 4 \times 10^{-5}$ , or odds of one in 25,000). (An entire summary of program data is shown in Table 5.)

(S) A second observation from that study is that in general, there is more variability from trial to trial for a given viewer than there is between the viewers themselves. There are no viewers in the group who have not shown some evidence for remote viewing, even though some of their individual series may not have reached the  $p < 0.05$  level of departure from chance expectation.

---

\* (U) In fact, each of these four series exceeded this requirement by more than an order of magnitude, reaching significance at the  $p = 0.003$  level or better.

~~SECRET~~



~~SECRET~~

Table 5  
(S) PROGRAM SUMMARY (U)

Remote Viewer	Local Bay Area Sites	Real Time Slides	Future RV Slides	Extended RV (Objects)	Alphabet	Coordinate RV
155	NS*	NS	NS	--	--	--
292	NS	NS	NS	--	--	--
372	<0.003 <sup>†</sup>	0.017	--	--	CS <sup>‡</sup>	--
468	<0.003	--	NS (p = 0.1)	--	--	--
518	<0.003	{ 0.04 (pictorial) 0.075 (verbal & pictorial)	--	{ p = 0.05 (one judge) NS (2nd judge)	--	0.008
690	<0.002	--	--	--	--	--

\* Nonsignificant result.

<sup>†</sup> Probability of obtaining result by chance.  $p \leq 0.05$  is accepted standard threshold for labeling a result significant, that is, non-chance.

<sup>‡</sup> Clearly significant, but difficult to obtain precise probability value.

~~SECRET~~

~~SECRET~~

(S) With regard to screening:

- (1) The individuals chosen to participate in the program were pre-screened by the client from a population of 250 potential candidates, using broad personality profile guidelines recommended by SRI, with final selection determined on the basis of interview by the SRI project leaders (R. T. and H. P.). The fact that the overall study was successful lends support to the effectiveness of this initial screening-by-profile procedure.
- (2) The details of the results of the program indicate that a half dozen local-site RV trials may constitute a meaningful screening-by-performance procedure to separate the more reliable from the less reliable viewers. In order for screening-by-performance to be successful, it is necessary that the performance of a viewer be relatively consistent. We find that those individuals who were the most successful in the Phase-One trials, were also the most successful in Phase-Two, even though different remote viewing tasks were pursued. Of the four successful viewers in Phase-One, two produced significant results and one near-significant (the fourth was not available for the Phase-Two study). The two viewers from Phase-One that were least successful there (not reaching significance) again did not reach significance in Phase-Two. Although the sample is too small to be definitive, it appears that the Phase-One local-site RV series itself offers evidence of constituting a useful screening-by-performance procedure.

*Handwritten notes:*  
11 PK

(S) The data indicating that a viewer can describe an individual slide as it is shown on a screen shows that targeting on high-resolution transient targets (charts, maps, etc.) is not out of the question. This, coupled with our findings that a viewer may be able to describe and identify alphabet letters is a most encouraging development, and one deserving of further work. Extension of the RV process to include high-resolution material, especially with a reading ability, would constitute a significant breakthrough for operational applications.

*Handwritten notes:*  
for some reason  
11/11/77

~~SECRET~~

~~SECRET~~

(S) Certain of the individual responses in the FRV (future remote viewing) series, both with slides and with local sites as targets, appeared to give striking evidence of contact with the target. However, the trial-to-trial reliability was low and no series reached statistical significance. Therefore, although individual results were encouraging, no definitive statement can be made on the basis of this short study. Given its obvious applications potential, should its existence be capable of unambiguous verification, we consider it a high-priority item for further exploration.

(S) In the extended remote viewing (ERV) trials a viewer was able in each trial of the series to identify significant elements of an object placed in various locations, including an SI/TK tank under conditions of tight security. In these experiments the remote viewer worked alone over extended periods of time (up to three hours). At a minimum, the good results indicate that the RV process is not so fragile that it must be carried out under rigidly-specified conditions, since in this case an alternative style was in use and the results continued to be reliable. Further work would be required, however, before a definitive comparison of RV and ERV could be made.

(S) Finally, the encouraging results obtained in the CRV (coordinate remote viewing) trials indicates that comparable accuracy and reliability can be expected from experienced viewers targeting either on the basis of a beacon person at the target, or on the basis of geographical latitude and longitude alone. As a by-product of the CRV study, which involved the use of special procedures being developed in another program for reliability enhancement, the high-quality output provided additional confirmation as to the effectiveness of certain new approaches being taken with regard to monitor/viewer interaction and control of the RV environment.

~~SECRET~~

~~SECRET~~

(S) To take advantage of the most recent developments in remote viewing, and to achieve the goal of continuing to develop remote viewing into a reliable operational tool, we strongly recommend further development of capabilities in the following areas:

- Applications of Remote Viewing. A training procedure has been developed that appears to greatly increase both the accuracy and reliability of remote viewing by coordinates. This technique should continue to be examined, and applied to targets of operational interest, both with in-house and client-supplied assets.
- Effects of Feedback. An extensive examination should be made of the necessity for providing feedback in remote viewing trials. A systematic variation in the presence or absence of feedback should be used to determine the importance of this factor.
- Target Demarcation. Coordinate remote viewing experiments should be carried out in which the target is demarcated by means of various types of coordinates (e.g., geographic, military, and arbitrary). This should be done in order to discover the part played by the target coordinate in determining remote viewing accuracy.
- Audio Analysis. In an effort to separate correct from incorrect data available from taped subject descriptions of remote viewing target sites, the use of speech and audio analysis techniques should be investigated as a tool to provide selective editing. This should include semantic analysis, in which analysis of written transcripts are carried out to look for variations in grammar, style, or vocabulary to help separate correct from incorrect statements in the RV transcript.
- Tracking. Further effort should be pursued to perfect the RV process whereby, instead of demarcating a location to obtain a target description, one provides a target description and asks for location (as in locating a downed aircraft or foreign official). SRI has under development certain strategies involving FRV feedback, computer averaging of multiple trials, and so forth, which appear from pilot efforts to hold promise.
- Spatial Resolution. A study should be carried out to determine the extent to which it is possible to aid

*Verbal!*

~~SECRET~~

~~SECRET~~

(S)

viewers in learning to read hidden and distant printed material that is blocked from ordinary perception.

*or written*

- Temporal Resolution. An ERV effort should be pursued to determine the accuracy of remote viewing as a function of time for future targets.
- ELF Experiments. Since one of the prevalent hypotheses for paranormal perception requires the use of an ELF electromagnetic carrier, we suggest carrying out definitive experiments to examine this hypothesis (e.g., by using ELF generators as beacons), and to provide analyses correlating data from our past data base with the daily record of geophysical parameters known to affect ELF propagation.
- Theoretical Studies. Modern physics offers several mathematical descriptions of reality that may also prove to be testable descriptions of paranormal perception in general, and remote viewing in particular. We recommend work with leading physicists who have agreed to consult for SRI on these theoretical problems, in an effort to develop a physical understanding of the phenomena we observe in the laboratory and in the field, and to apply this knowledge to improve remote viewing functioning.
- Technical Meetings. SRI proposes to host private quarterly conferences to bring together selected U.S. scientists and government representatives who are concerned with the technical issues in psychoenergetic research.

*or No. of trials*

?

?

*mostly*

(S) Successful pursuit of the above priority items could be expected to result in an increased reliability and breadth of utility of the RV function for operational purposes.

• Repetitive replication vs. analytical evaluation

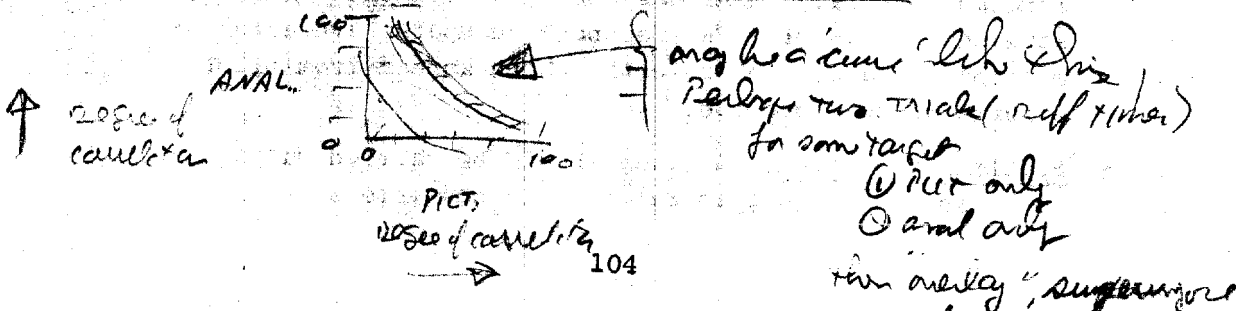

*is this a trial?*

~~SECRET~~

• Physiological ISSUES  
- GSR, etc.