

u/I object

Q

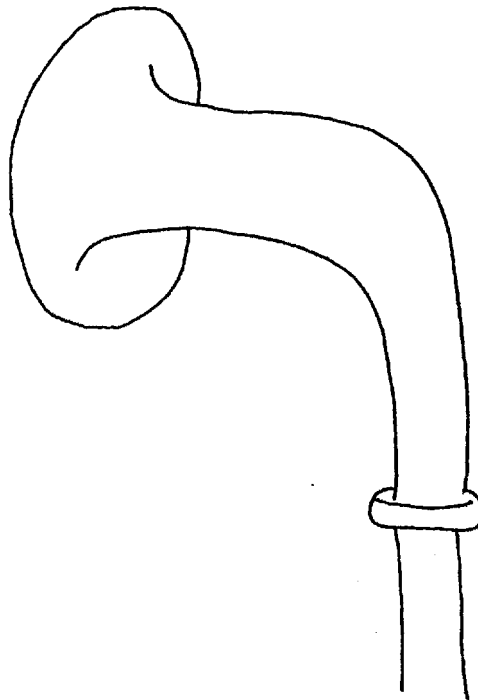

u/I object

079-1

Q

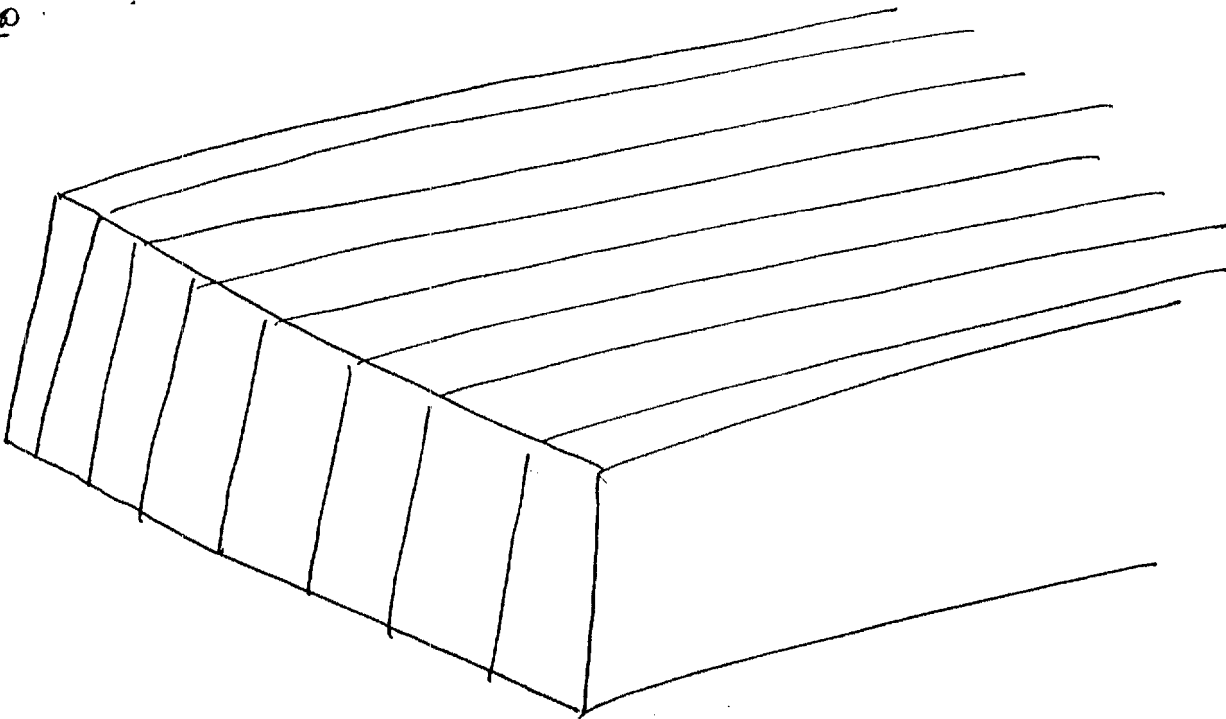

u/I object

Q

\* some sort of "flap"  
 that flips out from  
 main body of  
 larger object

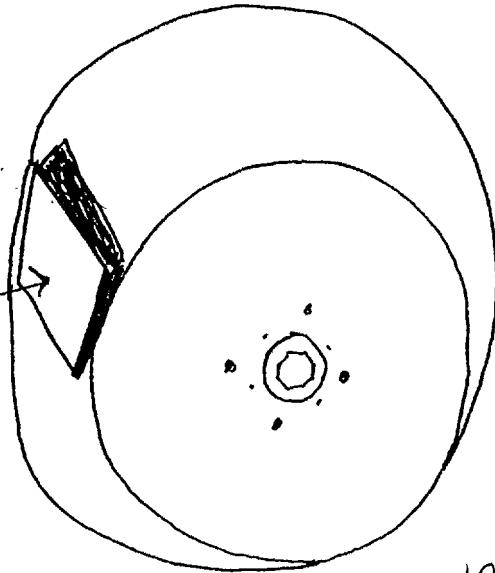

\* slowly turning; "flap" like  
 feature used for passing of  
 something, either into, or  
 out of, circular object.

079-2

CC

(2)

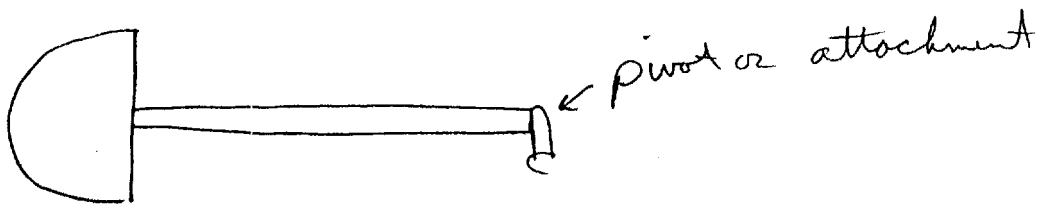

U/I object which slowly moves back  
in forth in a fan-like motion

(3)

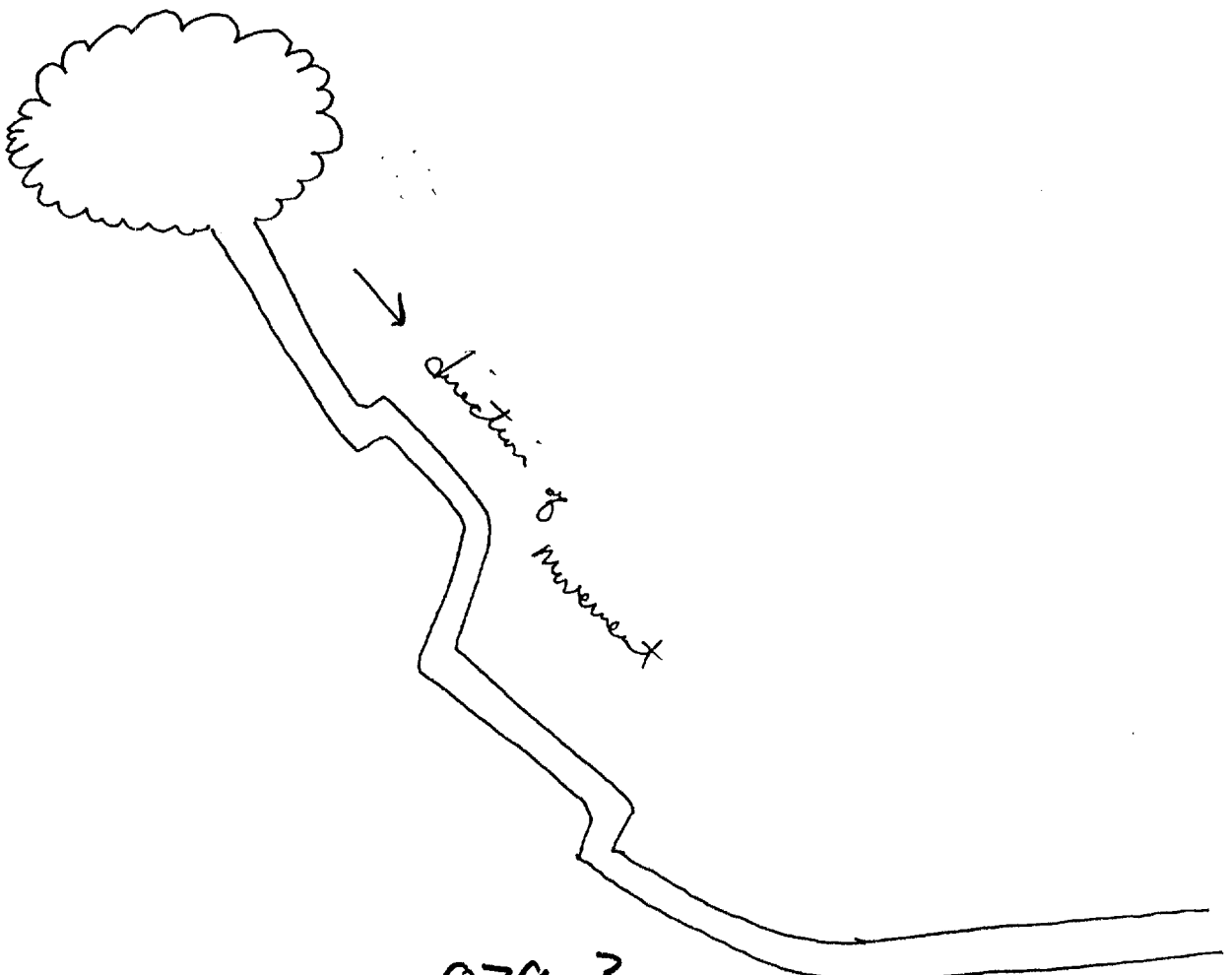

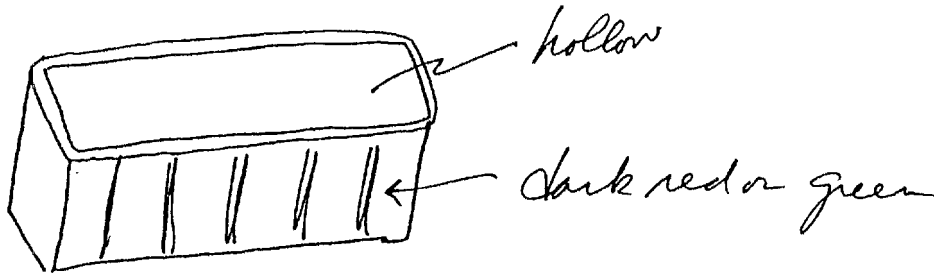

U/I object

(B)

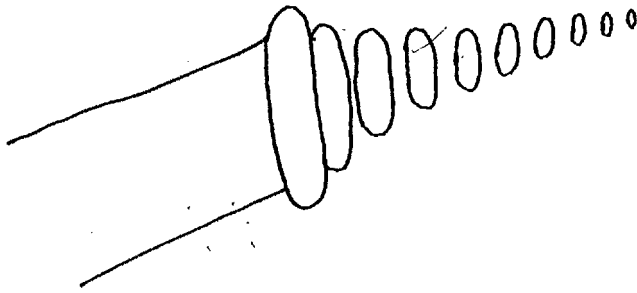

U/I object associated with pulsations  $\hat{=}$  high energy

079-4

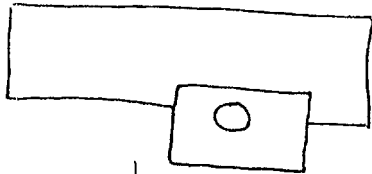

\* overhead view

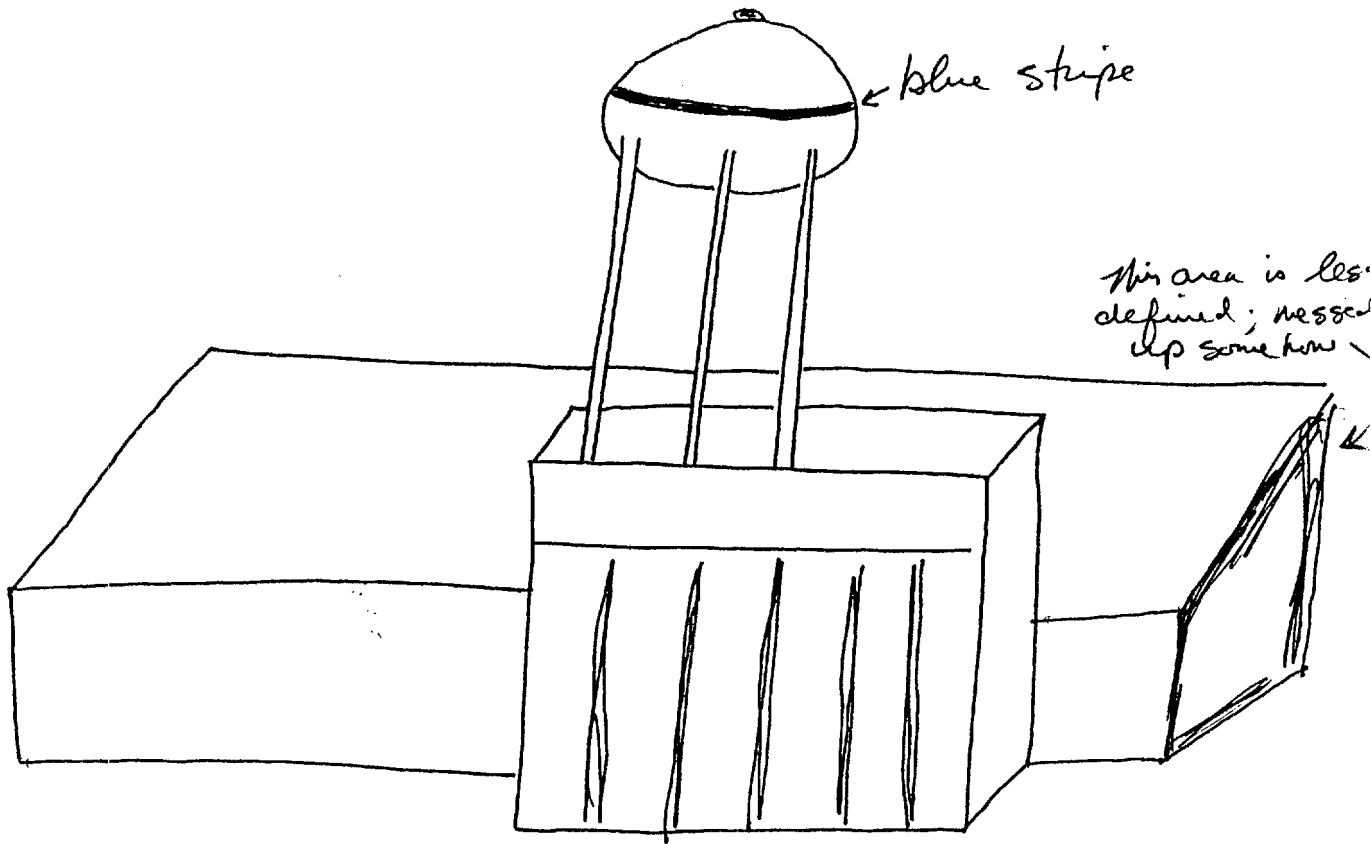

\* side view

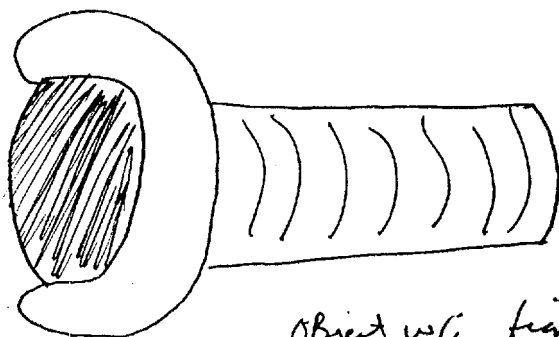

Object w/o figure above; hollow, large, mangled end at "opening"; spinning.

079-5

