

~~SECRET~~

DATA SUMMARIES

(S/NF/SG/LIMDIS) Following are the perceived highlights from each source.

- (S/NF/SG/LIMDIS) Source (Green Data):

-- The target personality Warlord Mohamed Farrah Aidid is currently located as marked on the attached map. The political leader is wearing red and is not traveling alone. There are men traveling on land with him and he may be moving in a southern direction. He is short of some supplies. This man is furious about certain issues, is in danger, and although he is a fighter, is now feeling tired. He is uncomfortable with staying in any one location for very long and is therefore, on the move.

- (S/NF/SG/LIMDIS) Source (Black Data):

-- The target is currently associated with a compound (see diagram, page 3a). This compound occurs on a street intersection in the outskirts of an established city (BELET WEYNE was the first perception) but it is not Mogadishu (see map plots).

-- The compound consists of:

--- A long, narrow, two to three story building. It has a distinctive blue or green metal "attachment" which extends from the structure front and angles up; a corner which appears to have deteriorated in some fashion; the surface of the side of the building appears woven or fabric-like (diagram, page 3b); with an angular design or feature along one side. The concept of "storage" is associated with this building. In addition, the concept of "textile mill" was also perceived.

--- A walled or barricaded-in open area. This area contains a series of low, upright cylindrically shaped objects which are associated with the concept of "containment"; a group

REPRODUCTION REQUIRES  
APPROVAL OF ORIGINATOR  
OR HIGHER DOD AUTHORITY

FURTHER DISSEMINATION  
ONLY AS DIRECTED BY DIA/PAG  
OR HIGHER DOD AUTHORITY

CLASSIFIED BY MULTIPLE SOURCES  
DECLASSIFY ON OADR

1

~~SECRET~~

NOT RELEASABLE TO FOREIGN NATIONALS  
STAR GATE

~~SECRET~~

~~SECRET~~

of large "coils" laying on their sides (diagram 2, page 3c); an area containing a number of similar objects scattered about (diagram 2, page 3g); and an area which contains an additional upright flattened cylinder (this area "looks" out of place with the other components within the compound).

--- A gate-like entrance with associated dark brown or green wooden features (diagram, page 3d). This "gate" leads to an area used for sitting or waiting. There is a stone or cement bench along one side of this "waiting" area.

--- A squared-off, hard sided trench or gutter-like feature running in front of the "gate" feature (diagram 1, page 3f).

-- Continuing out the "back" of the compound leads to a large area which is open and flat. A large "wadi" or "arroyo" runs close to the compound in this large, open area.

-- There is a playground located close to this compound. One of the streets which runs along side of the compound is named "WADI \_\_\_\_\_". Other phonetics associated with this compound are: KHASRA and ILIM or ILEEM. The Arabic word *بَلَم* is on the side of the building.

-- Associated with and/or located near the compound were the following features and/or objects: (Diagram 1, page 3e), consists of another upright, flattened cylinder with a "spreading" feature extending upwards from the center. Diagram 2, page 3e, consists of a "large, bumpy metal plate" which covers a subsurface "access" area. This plate is currently "frozen" in place but once swung up and down. There are a number of curved pipes and round handled objects i.e. valves, located in one corner of the sub-surface "access" area. Diagrams 2 and 3, page 3f, depicts an unidentified cylindrically shaped object attached by two "arms" to a large, solid object. Diagram 1, page 3c, depicts an unidentified object which is associated with moving smaller, uniformly shaped objects from a horizontal movement to one that angles up. Diagram 1, page 3g, depicts a curved, metal object with a "tube" extending out from the convex side.

-- Additional concepts associated with the target are: earth moving equipment; dogs barking; stone or cement blocks; an object shaped like a "boat's bow hull" spinning on its axis; three or four large, oversized books lying open, one on top of another (these books have distinctive gold colored floral designs highlighting the covers); and a building with four levels.

~~SECRET~~

NOT RELEASABLE TO FOREIGN NATIONALS  
STAR GATE

~~SECRET~~

-- There is a man in soiled pants reminiscent of faded desert fatigues. He approaches a window and looks downward after a heated discussion with a man browsing over the aforementioned books. They are both concerned with something "just outside". There are a number of leather carrying bags associated with these men.

-- Associated with this concept of "just outside" were the following impressions: Looking out; temperature difference; children nearby; confusion; and noisy.

~~SECRET~~

NOT RELEASABLE TO FOREIGN NATIONALS  
STAR GATE

~~SECRET~~

Agreement of the hand raised; like a hand or gesture.

Sketch name in the field...

Low, narrow, 2 or 3 story building; feels like "storage" here.

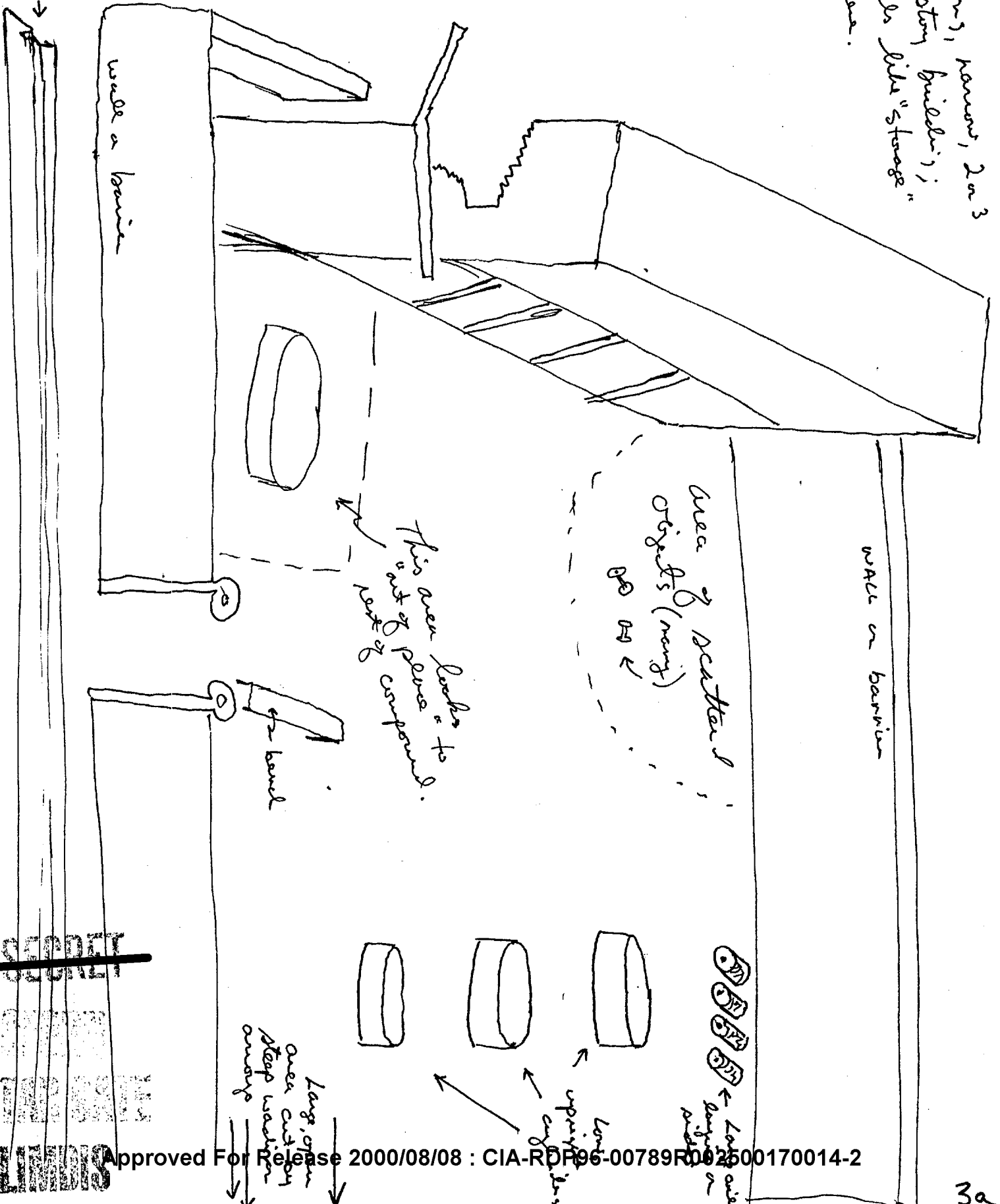

wall or barrier

wall or barrier

Area of scattered objects (many)

This area looks to be out of place to rest of compound.

Long, open Area cut by steep wash on slope

Long, open Area cut by steep wash on slope

Long axis

~~SECRET~~



~~SECRET~~

This portion of object moves or pivots up & down

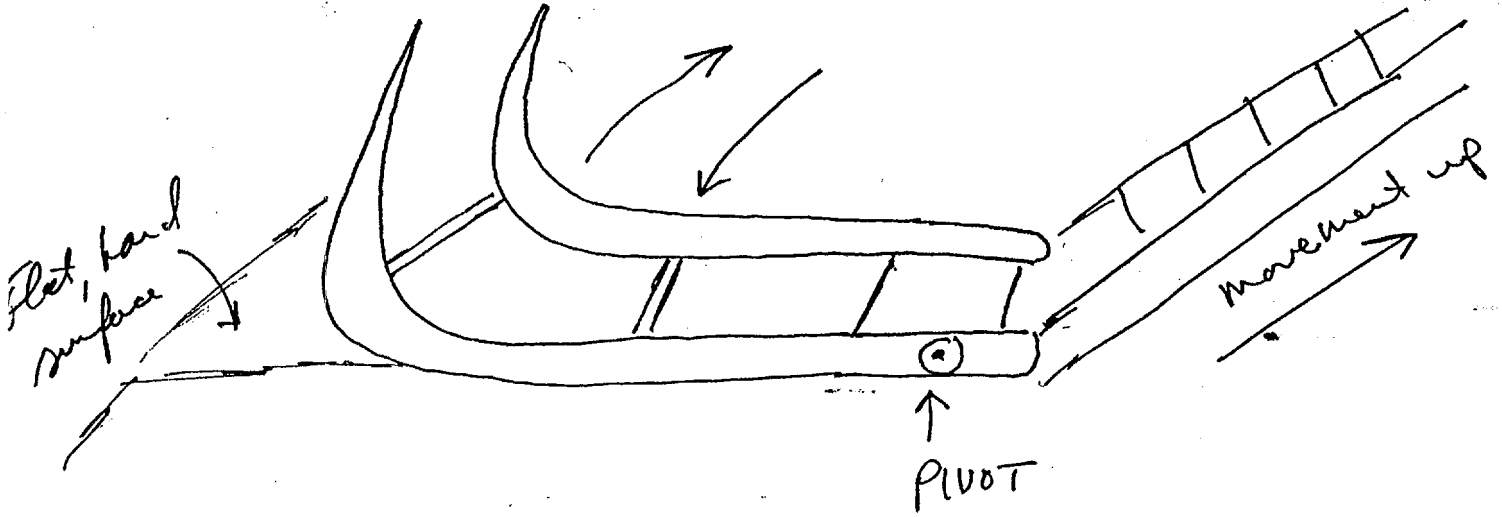

①

②

Large coils of wire or tubing.

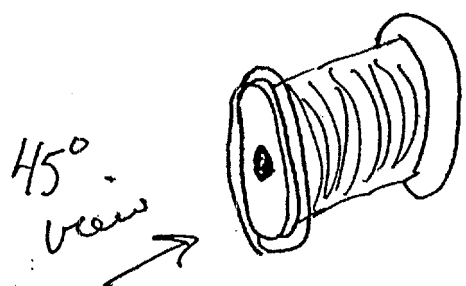
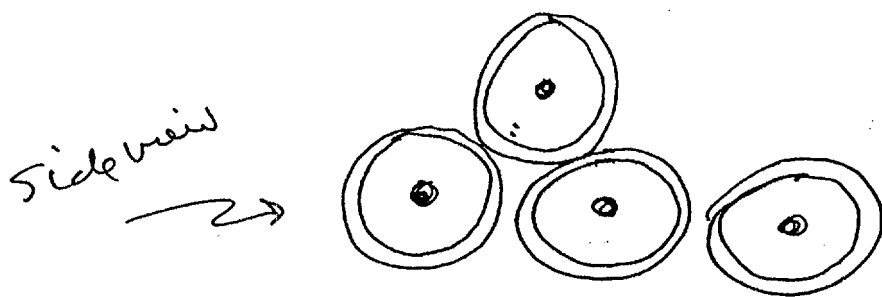

~~SECRET~~

NOFORN

STAR GATE  
LINKS

~~SECRET~~

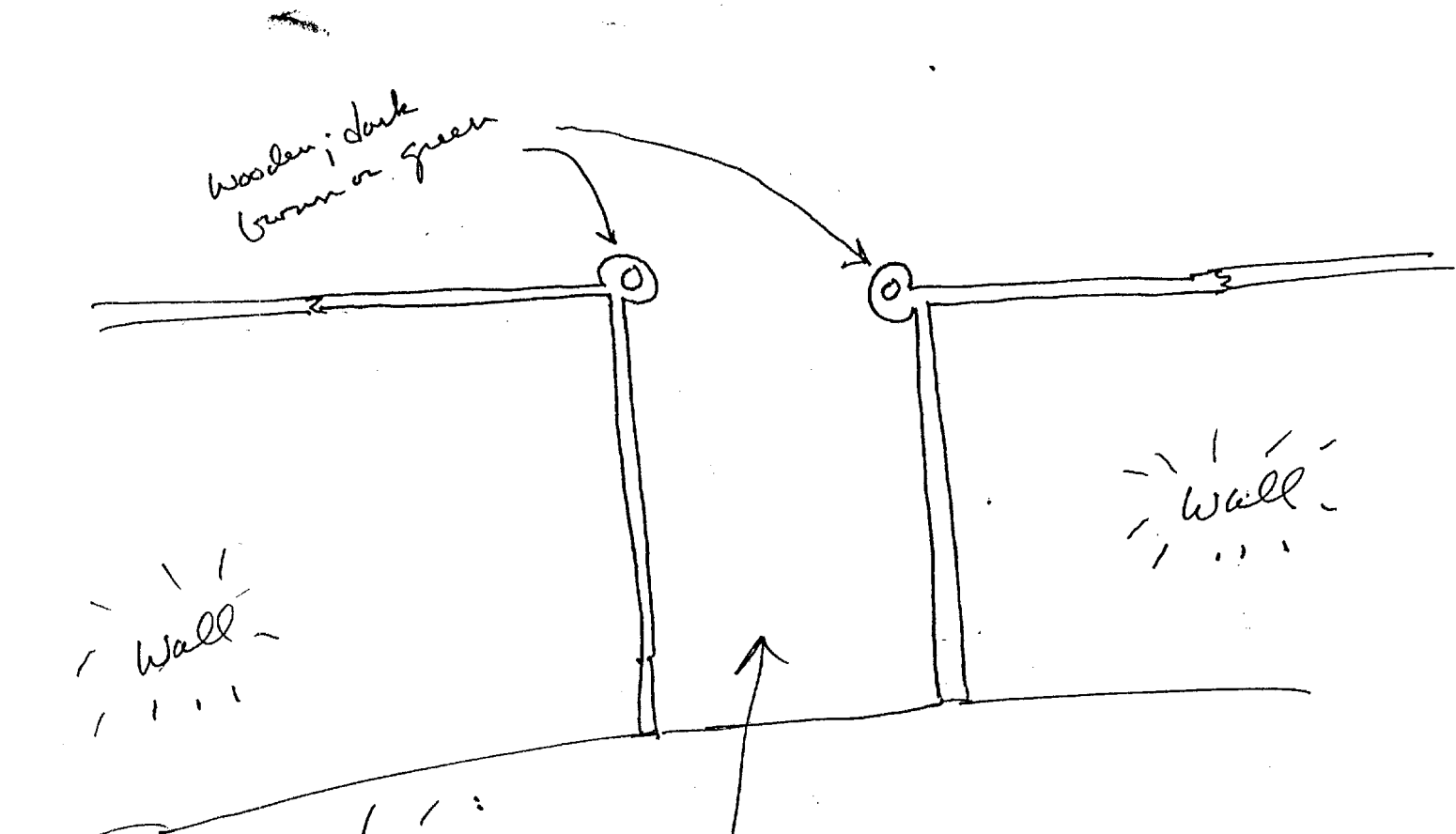

wooden; dark brown or green

Wall

Wall

street-like feature

leads to an area used for sitting or waiting.

\* Stone or cement bench along one side of area

~~SECRET~~

NOFORN

STOP DATE

~~SECRET~~

~~SECRET~~

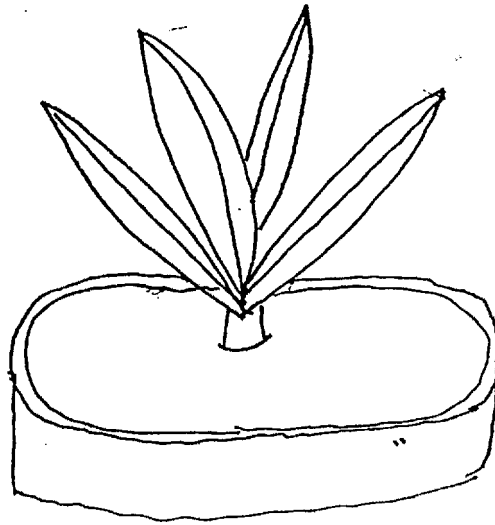

①

②

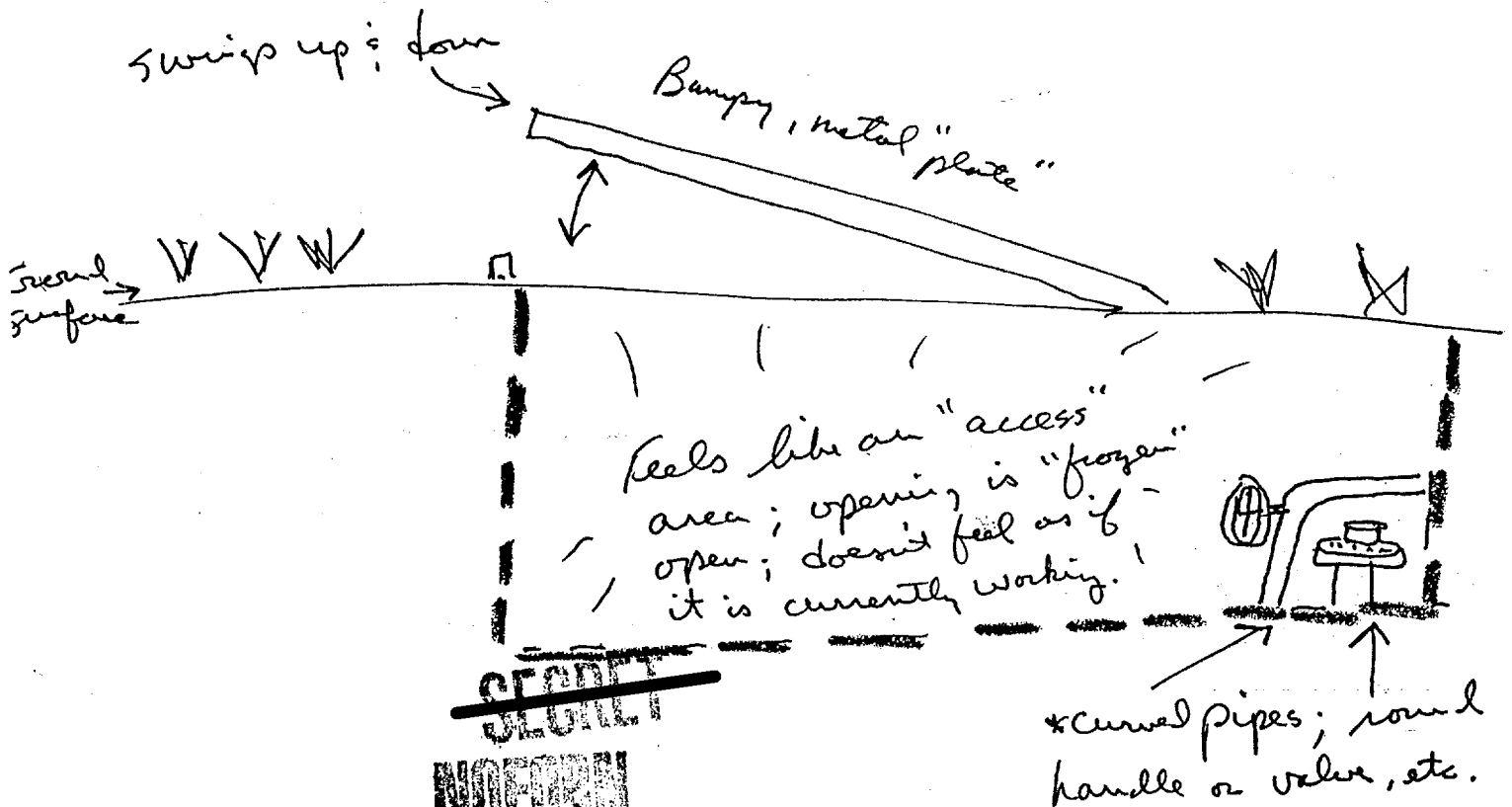

~~SECRET~~

~~NOFORN~~

OTDR GATE LINDIS



~~SECRET~~

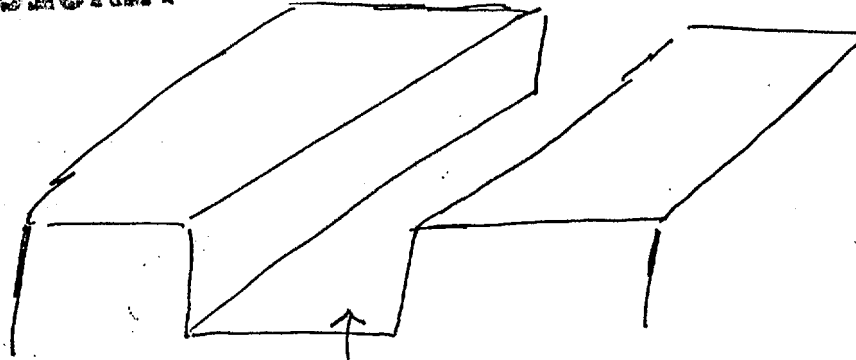

Squared-off "cut" through  
surrounding hardness; feels  
dirty, decaying in here.

①

feels hollow inside

45° view  
→

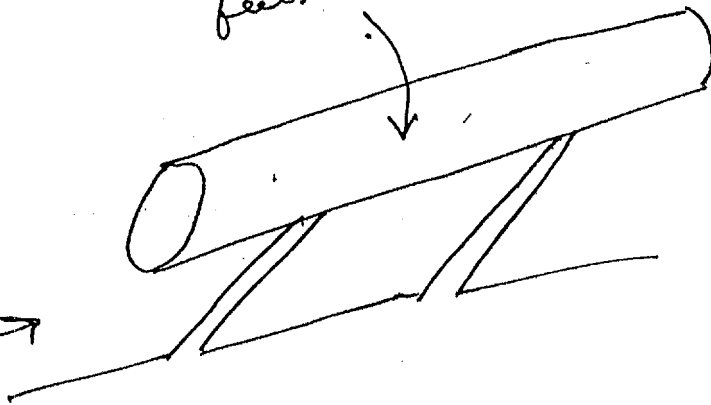

cylinder attached  
by two "arms"  
to solid object

②

③

Side  
view  
→

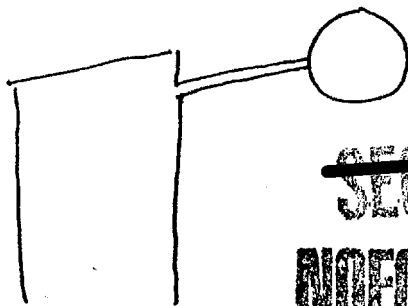

~~SECRET~~

NOFORN

STAR GATE

LINDIS

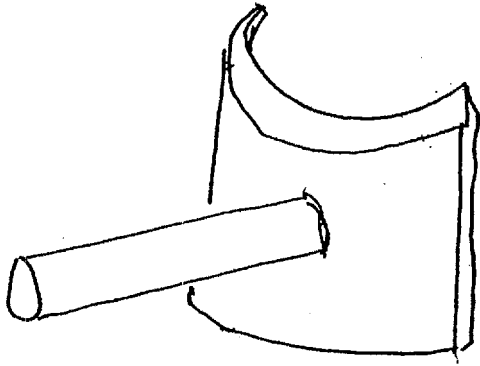

← Curved metal object  
w/ "tube" sticking out  
convex side.

①

②

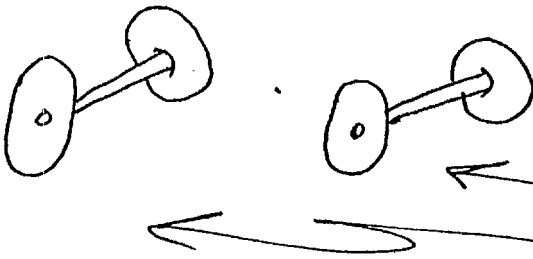

a number of these  
objects scattered  
about; ~~feel~~ when  
look wooden, feel  
denser

~~SECRET~~

NOFORN

STAR GATE

LIMITS

~~SECRET~~

- (S/NF/SG/LIMDIS) Source (Red Data):

-- Target personality is located on the outskirts of a city area. The individual can be found near a brown tunnel that is located west of the city. (See diagram, page 4a ) There will be a large truck that looks like a moving van that will have an accident near this bridge. Target personality is located near the northeast portion of the country (see map) but in the past has been in the southern region.

-- In the city, there is a large structure that is political in nature. (See diagram, page 4b) There is an object near or on the structure that is a big globe. (See diagram, page 4c) Although the structure is used for political purposes, other functions go on here and one is of entertainment.

-- The numbers 7231 or 7213 phonetically surfaced.

-- Target personality can be found in the area of Hafun Dante or Danakil.

-- The word "Danon/Danot" and hot climate were also perceived.

~~SECRET~~

NOT RELEASABLE TO FOREIGN NATIONALS  
STAR GATE

~~SECRET~~



formed  
 brown iron ore west of  
 Oskunk  
 of a large  
 town or city.

~~SECRET~~

NOFORN

~~STAR GATE LINDIS~~

4 a

*up structure*

*up*

*up of  
up of  
up of*

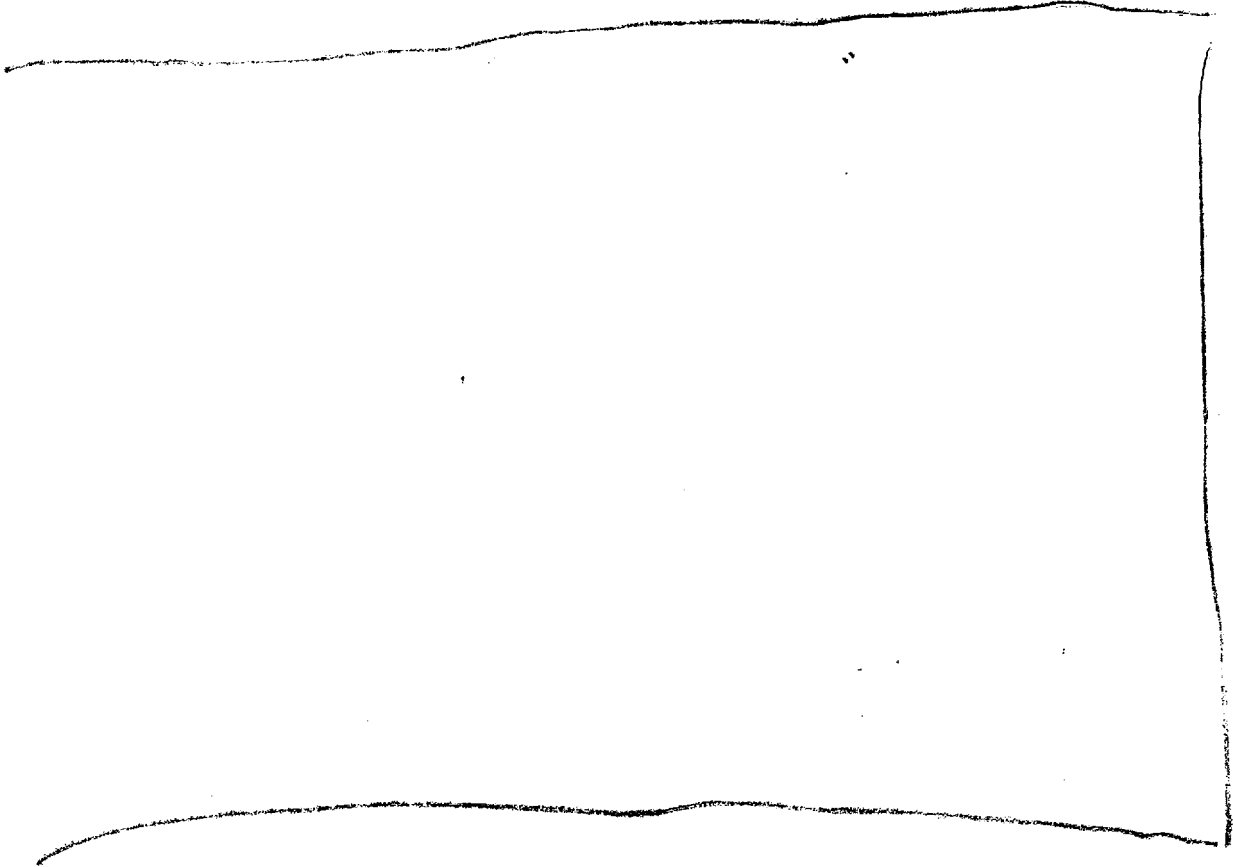
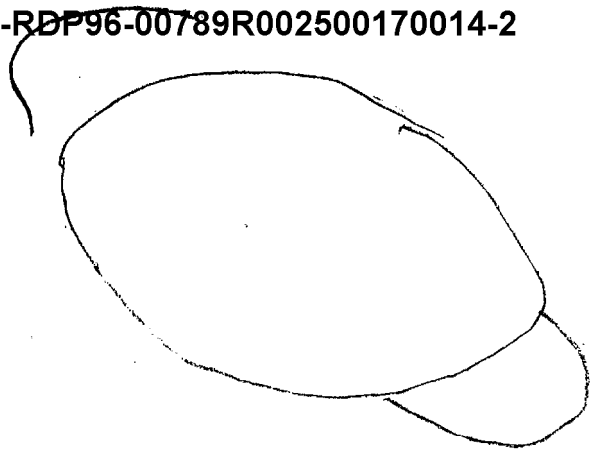

*large  
structure*

~~SECRET~~

NOFORN

STAR GATE LINDS

*46*

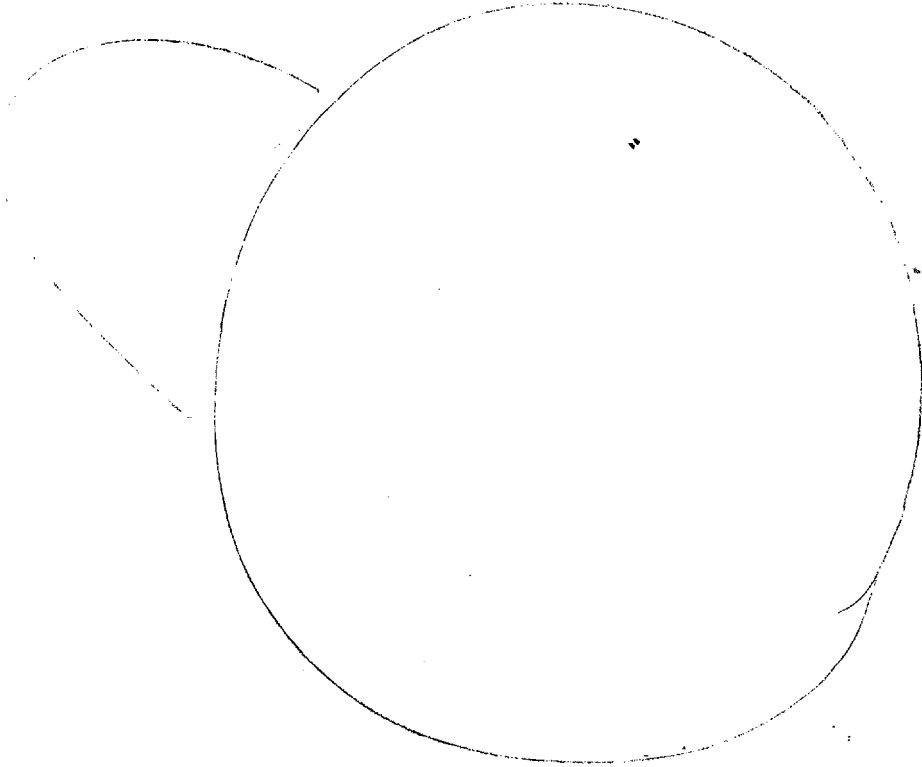

"Globe"  
large circular  
object in  
or near  
city.

~~SECRET~~

NOFORN  
STAR ONE

SECRET