

SESSION SUMMARY

A. SESSION DATA:

Task/Target No. 91-6-G Source No. 049
Date Task Received 8 Aug 91 Date Summary Returned 9 Aug 91
Session Date 9 Aug 91
Target Designator 116367 Session Start Time 1057
527170 Session Stop Time 1153
Beacon/Sender No. N/A Session No. 01
Session Type S Session Method CRV
(M)onitored, (S)olo (CRV, ERV, WRV, etc.)
Monitor No. (if any) N/A Estimate of Outcome M to H
(High, Medium, Low)
Possible Session Aids/ Distractions: General aggravation with
D.C.; confusion, etc.

B. SESSION SUMMARY: (Below, or see summary and worksheets attached)

All attached

Summary of Information

The target consists of a series of structures, some rounded, some angular. There is an overwhelming sense of "suspension" or being suspended over a vast emptiness here. Associated with this is the concept of "peakness" (?). There is a sense that there is an interest here to the public (i.e. sightseeing or exhibits) but this is not the primary function of the site.

Just as important as the sense of suspension is one of isolation and the feeling of "outworldlyness"; that is, the feeling of space, another planet or another world.

There is the concept of "communication upwards". There are spinning and lateral movements of both seen and unseen objects/substances. There is a general overall feeling of being on the edge of something and the concept of distance or being able to see a great distance. There is a sense of great height or depth as well. There are objects reminiscent of vegetation and pathways.

Overall, this site gives one a very pleasant, fresh and peaceful feeling.

DIAGRAMS:

i(a). AV Sketch: domed features; appear as a gourd which has been cut in half length-wise and lying on the ground.

i(b). Angular object which gives one the feeling of suspension over an emptiness (reminiscent of looking out over the Grand Canyon or something like that). There is a location (division) in which the hardness of the feature differs from one side to the other; in other words, two different "kinds" of hardness.

ii(a). U/I truncated object.

ii(b). Two rounded cone-shaped objects sitting point-to-point, slowly spinning around and undulating in a very "soothing" manner. These objects are a very dark or black color. Their surface looks wet, but isn't.

iii. Expanded view of ii(b). Spinning cone-shaped objects sit within the corner of a large room with high walls. The color of this area is dark blue into black with some sort of yellow or orange iridescent lights present. The objects are slowly spinning counterclockwise. There are small white points attached to the surface of at least the upper "cone". There is some feature which surrounds the base of the objects and acts as a barrier to "keep distance". This place has a "space" or "planetary" feel to it; that is, outer space.

iv. U/I object; curved surface with wooden-looking planks. This object has a wooden feel to it. There is a very nice smell, like cedar or pine, associated with this object. It reminds me of the "north". This feature is stationary but there is a sense that objects are rolled or moved along the surface of this.

v(a). Sketch related to i(b). Concept of suspension or being suspended over something.

v(b). "End-of-Session" A/S sketch. This resulted from the perceptions of "communication upwards", "isolation" and "outworldly" or feeling of another planet or world.

AU Sketch

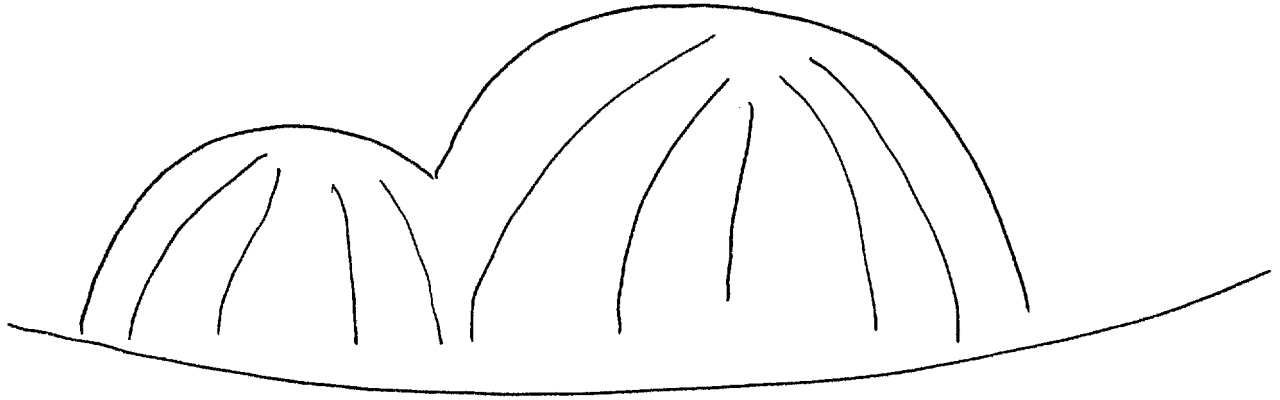

a

b

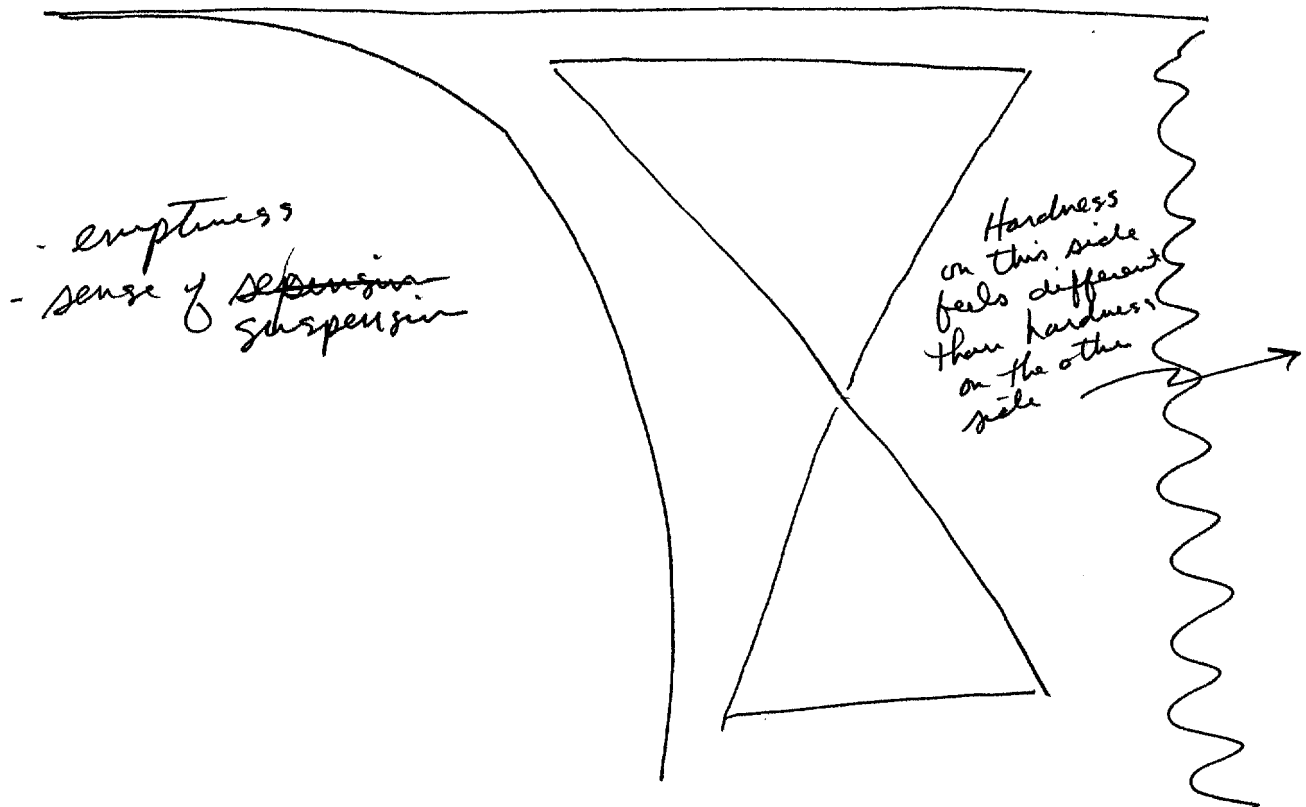

v/I object

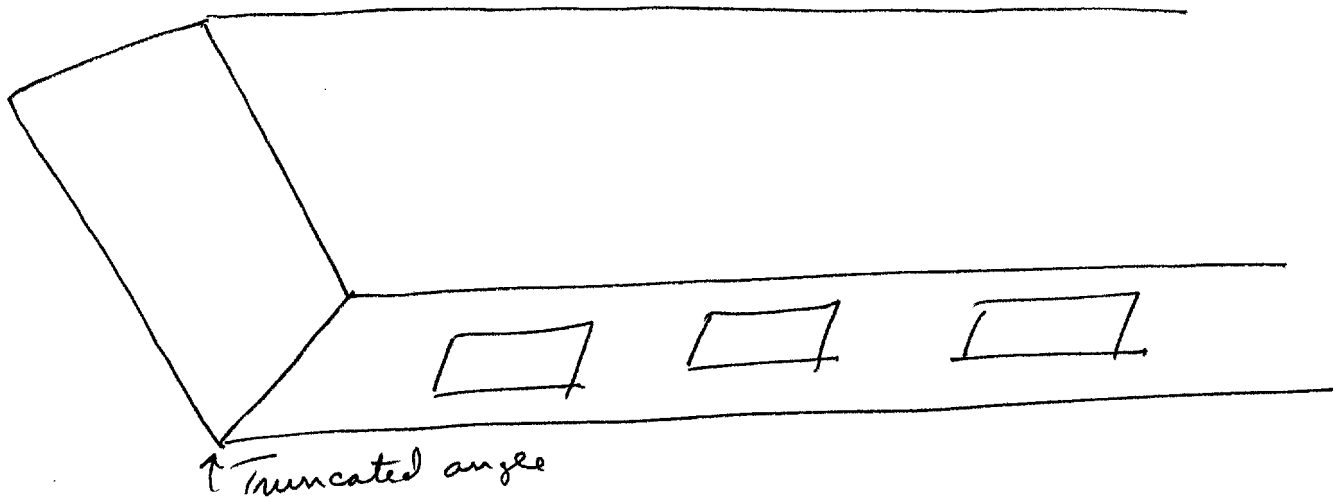

a

b

Two rounded cone-shaped
objects point-to-point,
slowly moving around

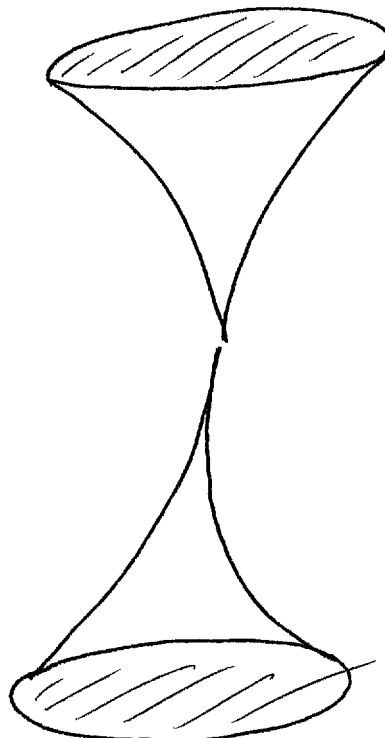

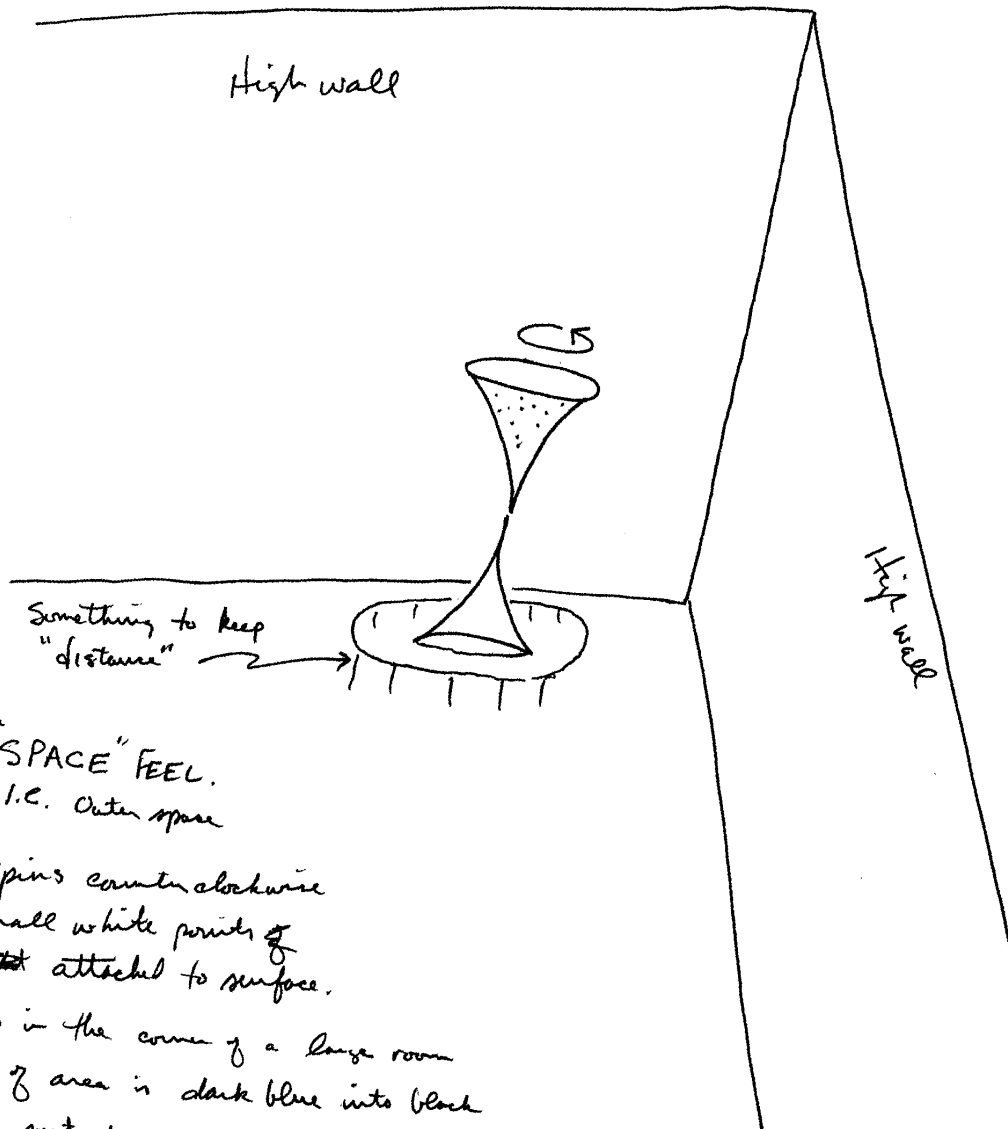

- "SPACE" FEEL.
I.C. Outer space

- Spins counter clockwise
- small white points of ~~light~~ attached to surface.
- sits in the corner of a lounge room
- color of area is dark blue into black
- some mix of yellow or orange incandescent lights present.

iii

u/I object

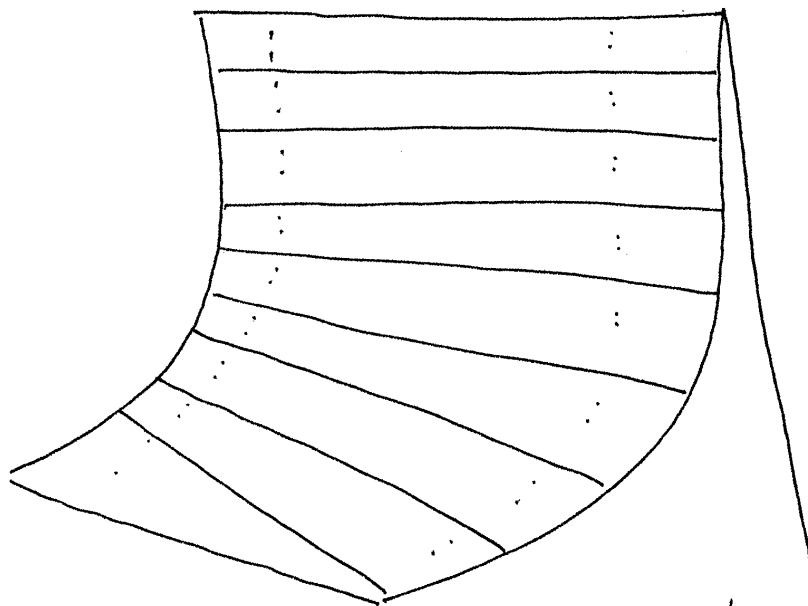

- Curved surface w/
wooden-like planks.
- wooden feel inside.
- as if objects are rolled
or moved along surface.

W

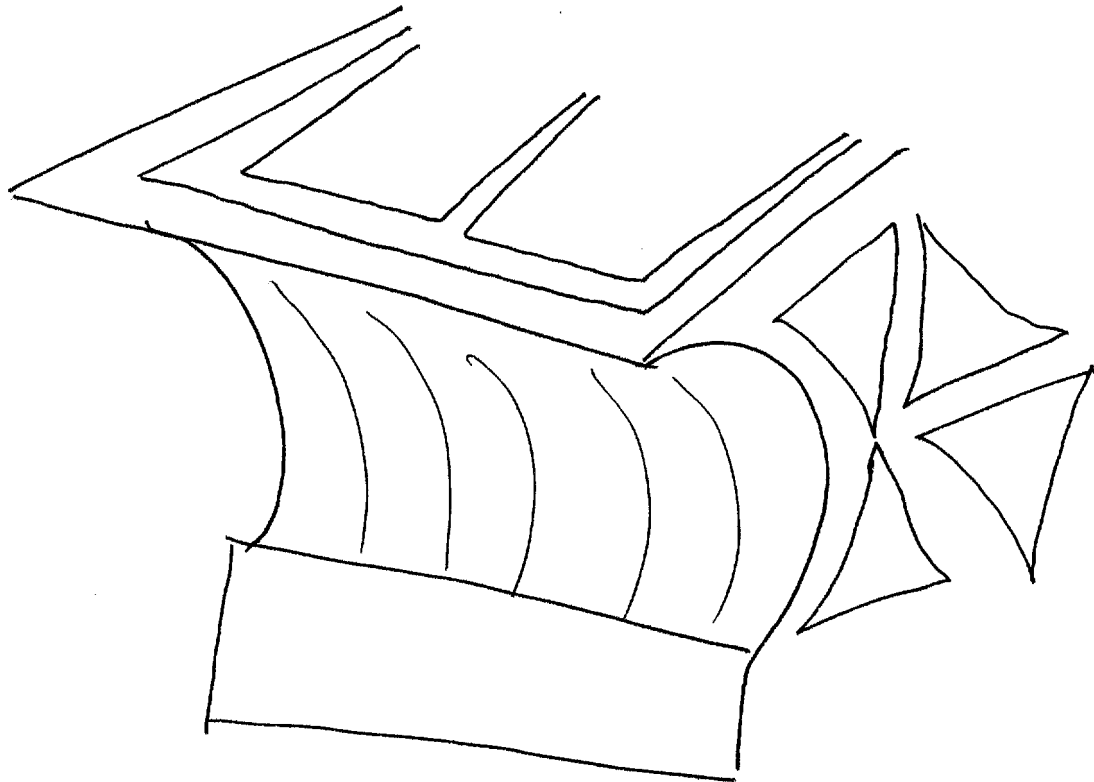

- Concept of suspension
or being suspended over
something

a
b

End of session A/s sketch

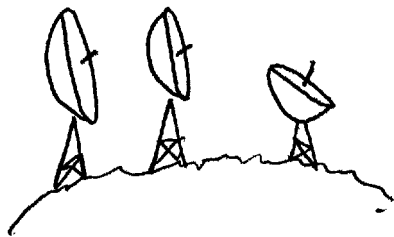

- sense of communication
upwards.

v

SESSION TASKING SHEET

Source No. 049

Date Task Initiated 8 Aug '91

Suspense Date 9 Aug '91

Task/Targeting No.: 91-6-G

~~Method/Technique:~~ Method of Choice

Target Data Desired:

1. DESCRIBE KEY TARGET FEATURES (include forms, shapes, spatial aspects, color, motion/dynamics):

- Emphasize the following: _____
- Do the following perspectives:
 - Ground-level
 - Overview
 - Other: _____

2. IDENTIFY KEY TARGET CONTENT (include meaning, purpose, function, nature of activity, type/nature of people, if present):

- Emphasize the following: _____

3. IF PERSONALITY, DESCRIBE: _____

4. OTHER: (or see attached) Training target is

others than a personality target

5. ADDITIONAL GUIDANCE: (see attached)

- Optional Coordinates: 116367/527170
- Submit summaries NLT 1200 hrs, 9 Aug 91