

**SECRET**

*Final Report*

*October 1982*

# PSYCHOENERGETICS RESEARCH IN THE PEOPLE'S REPUBLIC OF CHINA (1982) (U)

*By:* HAROLD E. PUTHOFF

*Prepared for:*

DEFENSE INTELLIGENCE AGENCY  
WASHINGTON, D.C. 20301

Attention: [REDACTED]  
DT-5A

SG1J

CONTRACT MDA908-82-C-0034

SPECIAL ACCESS PROGRAM FOR GRILL FLAME.  
RESTRICT DISSEMINATION TO ONLY INDIVIDUALS WITH VERIFIED ACCESS.

WARNING NOTICE  
Intelligence Sources  
and Methods Involved

333 Ravenswood Avenue  
Menlo Park, California 94025 U.S.A.  
(415) 326-6200  
Cable: SRI INTL MPK  
TWX: 910-373-2046

NOT RELEASABLE TO  
FOREIGN NATIONALS



**SECRET**

Approved For Release 2000/08/11 : CIA-RDP96-00792R000400320001-8

1. DATE SENT <b>10/27/82</b>		2. REG. NO. <b>013 067 509</b>		3. COUNTRY <b>CIA-RDP96-00792R000400320001-8</b>		4. PARTS OR SERIAL NO. <b>4028</b>		5. FROM <b>L. Lavelle CC26AA</b>			
6. SRI CONTROL NO. <b>SRI/GF-0201</b>		7. COPY NO. OF COPIES <b>Cy #14</b>		8. CLASS <b>S/NF/MI</b>		9. TITLE OR DESCRIPTION OF THE MATERIAL <b>Final Report "Psi Research ..." Oct '82 (U)</b> ----- last item -----					
10. SENT TO: <b>LTC Robert Jachim</b> <b>U.S. Army - Bldg. 4553A</b> <b>HQ INSCOM - Det. G</b> <b>Ft. Meade, MD 20755</b>				SIGNATURE <i>R Jachim</i>		DATE RECEIVED <b>1 NOV 82</b>		NAME - PRINTED <b>ROBERT JACHIM</b>		TITLE <b>Ms. Leslie Lavelle</b> <b>P.O. Box 941</b> <b>Menlo Park, CA 94025</b>	

CUSTODY RECEIPT FOR CLASSIFIED MATERIAL:

Approved For Release 2000/08/11 : CIA-RDP96-00792R000400320001-8 RECIPIENT'S COPY

SRI 1802R1: UNCLASSIFIED WHEN SEPARATED FROM CLASSIFIED ENCLOSURES

**SECRET**

**SRI International**

*Final Report  
Covering the Period October 1981 to October 1982*

*October 1982*

**PSYCHOENERGETICS RESEARCH IN  
THE PEOPLE'S REPUBLIC OF CHINA (1982) (U)**

*By:* HAROLD E. PUTHOFF

SG1J

*Prepared for:*

DEFENSE INTELLIGENCE AGENCY  
WASHINGTON, D.C. 20301

Contract No: MDA908-82-C-0034  
SRI Project 4028

Attention: [REDACTED] DT-5A

**SPECIAL ACCESS PROGRAM FOR GRILL FLAME.  
RESTRICT DISSEMINATION TO ONLY INDIVIDUALS WITH VERIFIED ACCESS.**

Copy No. **11** .....

*Approved by:*

*This document consists of 68 pages.*

SRI/GF-0201

ROBERT S. LEONARD, *Director  
Radio Physics Laboratory*

DAVID D. ELLIOTT, *Vice President  
Research and Analysis Division*

**WARNING NOTICE**  
Intelligence Sources  
and Methods Involved

CLASSIFIED BY: DT-5A  
REVIEW ON: 31 October 2002

**NOT RELEASABLE TO  
FOREIGN NATIONALS**

**SECRET**



**SECRET**

CONTENTS (U)

ABSTRACT (U) . . . . . v

I BACKGROUND AND OVERVIEW (U) . . . . . 1

    A. Chronology of Major Events (U) . . . . . 1

    B. Official Policy (U) . . . . . 3

II EAST-WEST EXCHANGE (U) . . . . . 7

    A. China Psychoenergetics Tour--Introduction (U) . . . . . 7

    B. Institute of High Energy Physics (Beijing) (U) . . . . . 8

    C. Shanghai Meeting with Editorial Staff of 'Nature'  
    ('Ziran Zazhi') (U) . . . . . 10

    D. PRC Representation at Cambridge Conference (U) . . . . . 12

III ASSESSMENT AND CONCLUSIONS (U) . . . . . 17

    A. Assessment (U) . . . . . 17

    B. Conclusions (U) . . . . . 18

REFERENCES . . . . . 21

APPENDICES

    A EXCEPTIONAL HUMAN BODY RADIATION (U) . . . . . 23

    B STUDY OF THE EXTRAORDINARY FUNCTION OF THE HUMAN BODY  
    IN CHINA (U) . . . . . 37

    C PARTIAL BIBLIOGRAPHY ON CHINESE WORK ON EHBFB (U) . . . . . 49

SG1B

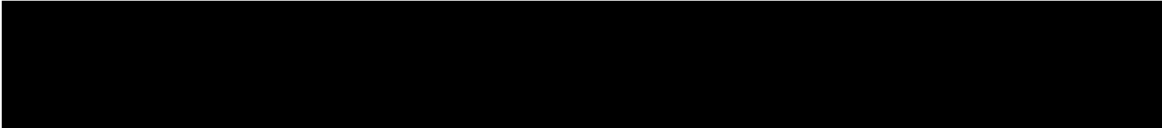

**SECRET**

**SECRET**

ABSTRACT (U)

(U) In this document we review the recent (1979 to present) rapid escalation of interest and research activity in psychoenergetics phenomena\* in the People's Republic of China. This includes evidence of large-scale screening for talented individuals, officially-sanctioned pursuit of research at the national laboratory level, continuing publication of results in leading scientific journals, and official PRC representation at international conferences on psychoenergetics phenomena.

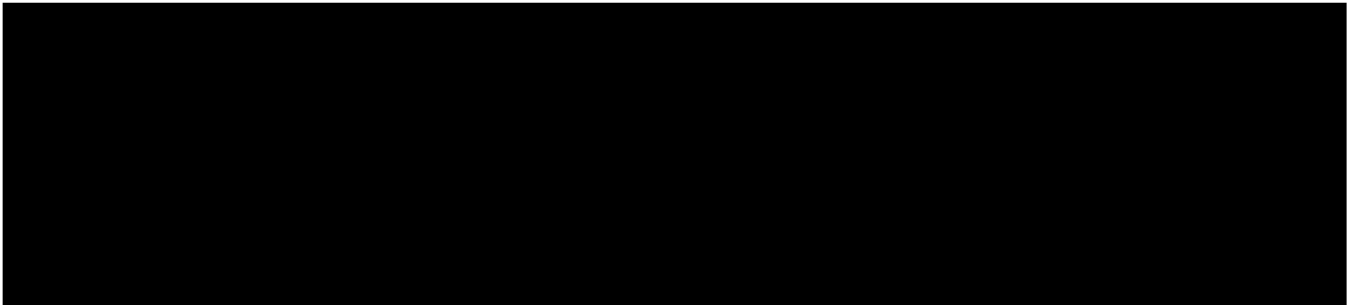

SG1B

---

\* (U) Definition: Human-mediated effects consisting of (1) the acquisition of information not presented to any obvious sense, (2) the generation of physical effects not mediated by any obvious mechanism.

**SECRET**

**UNCLASSIFIED**

## I BACKGROUND AND OVERVIEW (U)

A. Chronology of Major Events (U)

(U) Although interest in exceptional human functioning has historically been part of China's tradition, "parapsychological" or "psychoenergetics" studies have until recently been unacceptable as a subject of inquiry under Marxist rule. As recently as 1975, for example, the official journal of the Chinese Academy of Sciences, Scientia Sinica, carried an article critical of increasing U.S. and Soviet interest in psychoenergetics.<sup>1</sup>

(U) A reversal of this viewpoint can be traced to a report in the March 11, 1979, Sichuan Daily, which apparently acted as a trigger for renewed interest and exploration. In that report it was claimed that a 12-yr-old boy, Tang Yu, was able to read written material placed in physical contact with his ears. Although this claim was soon being criticized as unscientific in, e.g., The People's Daily in May 1979, reports began to surface from all over China that children elsewhere were duplicating this feat.

(U) In September 1979, a major monthly science journal, Nature (Ziran Zazhi), carried a report entitled "Observation Report on the Non-Visual Recognition of Images." This report, written by a correspondent of the journal on the basis of his own personal observations, provided support for the claims.<sup>2</sup> The journal then followed up in its October-December issues with additional reports on experimental observations by scientists at Beijing\* (Peking) University and elsewhere, which provided additional evidence for authenticity of the claims.<sup>3-6</sup>

---

\* (U) "Peking" is translated as "Beijing" in the newer Pinyin transcription system, declared the official system of the PRC in 1958.

**UNCLASSIFIED**

**UNCLASSIFIED**

(U) These reports caught the attention of scientists throughout China, many of whom assumed that some form of rudimentary biological function was at cause, since early reports typically involved "reading" through the skin. As a result, the initial approach to the phenomenon by the Chinese scientists parallels in many respects earlier similar work of Romains on "eyeless" sight<sup>7</sup> and Soviet investigations into so-called "dermo-optic" perception.<sup>8</sup> From this beginning, such functioning in China goes under a rubric that translates as Extraordinary Human Body Function (EHBf). From its original association with "skin-reading," this phrase has now been broadened to include the entire range of phenomena that in the West are called "parapsychological" or "psychoenergetic," since it was not long before the reading of Chinese characters, numbers, etc. extended to experiments involving noncontact forms of the phenomenon (e.g., use of sealed containers, long distances, and so forth).

(U) As a result of growing scientific interest, in February 1980 the "First Science Symposium on the Extraordinary Function of the Human Body" was held in Shanghai, sponsored by the editorial department of the journal Nature. Participants from over 20 colleges and research institutes were in attendance, along with 14 children purported to possess EHBf skills, which they demonstrated at the conference.<sup>9</sup> As a result of these demonstrations a number of observers returned to their institutes to set up research programs, and rigorous investigations began in earnest.

(U) These efforts were followed by a "Second Science Symposium in the Extraordinary Function of the Human Body," held in Chongqing in May 1981. At that symposium a professional group, the "Preparatory Committee of the Chinese Human-Body Science Institute," was set up to act as an organizing structure for work in the EHBf area.

(U) Throughout the 1980 to 1981 period a continuing series of papers on EHBf work were published in Nature, some of which have been translated

**UNCLASSIFIED**

**UNCLASSIFIED**

(U)

and are available in English.<sup>10</sup> The first presentation of EHSF research results to a professional audience outside of China took place at the 24th Annual Convention of the Parapsychological Association affiliate of the AAAS,\* held at Syracuse University, Syracuse, New York, August 1981. There, Professor Zheng Rongliang, Division of Biophysics, Department of Biology, Lanzhou University, on sabbatical to the Johns Hopkins University, Baltimore, Maryland, gave an overview of results reported to date.

(U) In October 1981 the State Science Commission set up a special group to study EHSF phenomena, and in February 1982 the Chinese Academy of Sciences sponsored a public hearing on the phenomena. In both formats a wide spectrum of viewpoints was aired, including discussion of examples in which it was concluded that deception had occurred.<sup>11</sup>

B. Official Policy (U)

(U) Despite criticisms from some quarters (notably, sociologist Yu Kwong Yu) official acceptance of the potential importance of the study of EHSF phenomena can be inferred from four key events in the 1981 to 1982 frame. One is the appearance of an entry on EHSF in the China Encyclopedic Almanac of 1981 in its column on science and technology. Although carrying a cautionary note that "there are still some people holding skeptical attitudes with respect to the authenticity of the extraordinary function of the human body," the development of the study of EHSF is discussed.

(U) A second indicator of official acceptance was the granting of permission for a visit to China in October 1981 by a delegation of American and Canadian parapsychologists, expressly to meet with Chinese researchers in the EHSF area. While in China members of the delegation had an

---

\* (U) American Association for the Advancement of Science.

**UNCLASSIFIED**



**SECRET**

(U)

opportunity to meet with EHSF research groups at Beijing (Peking) University, and at the Chinese Academy of Sciences' Institute of High-Energy Physics (also in Beijing), and to discuss at length reported research results and publication policies with the staff and Editor-in-Chief of Nature.

(U) A third indication of official interest was the decision by the PRC government to send two official representatives to the annual international convention of professional parapsychologists held in Cambridge, England, August 1982. These representatives, both Deputy Directors of the Institute of Space Medico-Engineering in Beijing, presented an authoritative summary of Chinese work in a Special Symposium on PRC Studies, chaired by Dr. H. E. Puthoff of SRI International.

(U) A fourth indication of official support for investigation of EHSF is provided by a statement by the Secretary-General of the Chinese Communist Party (CCP), Hu Yao-pang:<sup>\*</sup>

"This so-called Exceptional Human Body Function is not yet included in the different lines of present science which have been accepted. Therefore, before the real truth has been discovered, there should be no propaganda work on this subject, and for this reason there should be no antagonistic publication either. I think my two points are clear and fair. On this subject a group of a limited number of scientists should form a moderate-size research center to study and carry out experiments, and the results of their research work published for all those who are interested in this new line of science."

SG1B

---

\* (U) Hu Yaobang in Pinyin transcription.

**SECRET**

SG1B

Approved For Release 2000/08/11 : CIA-RDP96-00792R000400320001-8

Approved For Release 2000/08/11 : CIA-RDP96-00792R000400320001-8

UNCLASSIFIED

Table 1  
TIME-LINE PLOT OF MAJOR PRC ACTIVITIES IN PSYCHOENERGETICS FIELD

<ul style="list-style-type: none"> <li>▼ March 11--Sichuan Daily report on "Ear Reading"</li> <li>▼ September--Nature observation report on "Non-Visual Recognition of Images"</li> <li>▼ Oct-Dec--Nature reports on further experimental observations by scientists at Beijing (Peking) University and elsewhere.</li> <li>▼ February--Nature-sponsored "First Science Symposium on EHF," Shanghai</li> <li>▼ May--"Second Science Symposium on EHF," Chongqing</li> <li>▼ May--"Preparatory Committee of the Chinese Human-Body Science Institute" professional group set up.</li> <li>▼ Aug--EHF research results presented to 24th Annual Parapsychology Assoc. Convention, Syracuse, N.Y., by Lanzhou Univ. Prof. on sabbatical at Johns Hopkins.</li> <li>▼ Oct--State science commission sets up special group to study EHF.</li> <li>▼ Oct--Group of U.S. and Canadian parapsychologists visit Chinese labs and meet with researchers.</li> <li>▼ China Encyclopedic Almanac, 1981, entry on EHF</li> <li>▼ Feb--Chinese Academy of Sciences sponsors public hearing on EHF.</li> <li>▼ Aug--Two Deputy Directors of the Institute of Space Medicine Engineering, Beijing, present Chinese EHF results at 25th Annual Parapsychology Assoc. Convention (Cambridge, England).</li> <li>▼ Supportive statement by Hu Yao-pang, Secretary-General of the Chinese Communist Party</li> </ul>	
--	--

UNCLASSIFIED

**UNCLASSIFIED**

## II EAST-WEST EXCHANGE (U)

A. China Psychoenergetics Tour--Introduction (U)

(U) In October 1981 a group of 18 American and Canadian scientists, physicians and educators had an opportunity to visit the People's Republic of China, specifically for the purpose of meeting with Chinese researchers working in the EMBF area. The twelve-day stay, which took the group to the cities of Beijing (Peking), Xian, and Shanghai, was organized as a collaborative effort between a well-known American parapsychologist, Dr. Stanley Krippner, Dean of the Faculty of the Humanistic Psychology Institute in San Francisco, and Mrs. Shuhyin Mar, a retired University of Maryland mathematics instructor interested in EMBF phenomena, with family ties in China. Others in the group professionally involved in psychoenergetics research and members of the Parapsychological Association affiliate of the AAAS were, in addition to Dr. Krippner, Dr. H. E. Puthoff, researcher at SRI International; Dr. Marcello Truzzi, sociologist at Eastern Michigan University; Dr. Thelma Moss, psychologist/researcher in private practice; and Mr. Jerry Solfvn, Ph.D. candidate at Rijksuniversiteit, Utrecht.

(U) During the China stay, five formal technical meetings were held with scientists, physicians, and journal editors working in the EMBF field. The first was at the Friendship Hotel in Beijing; the second at the Beijing Medical College; the third, at Beijing University; the fourth at the Chinese Academy of Sciences' Institute of High-Energy Physics in Beijing; and the fifth at the Yanan Hotel in Shanghai with the editors and staff of Nature.

**UNCLASSIFIED**

**SECRET**

(U) The first discussions, held at the Friendship Hotel in Beijing, brought the visitors together with researchers and educators from the following institutions:\*

- (1) Beijing University physicists and biologists
- (2) Institute of High Energy Physics (Chinese Academy of Sciences)
- (3) Institute of Biophysics (Chinese Academy of Sciences)
- (4) Institute of Automation (Chinese Academy of Sciences)
- (5) Beijing Astronomical Observatory (Chinese Academy of Sciences)
- (6) Institute of Semiconductors (Chinese Academy of Sciences)
- (7) Institute of Physics (Chinese Academy of Sciences)
- (8) Physics Department of Beijing Teachers' College
- (9) Institute of Traditional Chinese Medicine of Beijing

(U) This was followed up by visits to Beijing Medical College, Beijing University, and the Chinese Academy of Sciences' Institute of High-Energy Physics.

(U) Note that those interested in psychoenergetics are primarily from the hard sciences, rather than from the psychological sciences as in the West. This is in large part because of the weaker position of the latter as a result of the excesses of the "Cultural Revolution," which led to suspension of Acta Psychologica Sinica and the closing of all university psychology departments as well as the Institute of Psychology.<sup>12</sup>

B. Institute of High Energy Physics (Beijing) (U)

(U) It was at the Institute of High-Energy Physics that the first opportunity for detailed discussion of specific experiments occurred.

SG1B

**SECRET**

**UNCLASSIFIED**

(U)

Invitees to the Institute were Dr. Krippner, tour leader; Dr. H. E. Puthoff, and Ms. B. H. Humphrey, researchers at SRI International; Mrs. Thelma Moss, who had done research in Kirlian (corona discharge) photography; and K. Zirinsky, MD, radiologist.

(U) The group was welcomed to the Institute in an opening meeting by Institute Deputy Directors Ho Lung and Li Yi. They expressed the opinion that EHF work was important and relevant to physics, and indicated that a small group of researchers, led by Zhao Yun-Je and Hsu Hung-Chang,\* spent approximately ten percent of their professional time researching EHF. This was followed by a seminar in which the work and its results were presented by Zhao.

(U) Their basic experiment, apparently replicated many times under widely varying conditions, consisted of the remote viewing of Chinese characters or numbers sealed in an opaque bakelite container, inside of which was also some form of detector to register possible physical effects corollary to the perceptions. The detectors used in this format included X-ray, nuclear emulsion, and photographic films, photoelectric tubes, thermoluminescence dosimeters, and biological (plant/polygraph) detectors. The claim made (backed up by raw data materials shown the visiting researchers, published pictures, and, later in the trip, motion picture film of the experiments) was that physical effects were registered during perception, and absent in the absence of perception. These included fogging of the films, and pulses on the electrical output devices of the various detectors. A summary paper describing these experiments was provided the visitors; it has been translated<sup>13</sup> and is provided here as Appendix A.

---

\* (U) Xu Hongzhang in Pinyin transcription.

**UNCLASSIFIED**

**UNCLASSIFIED**

(U) Technical evaluation of efforts such as those presented at the Institute of High Energy Physics is, of course, difficult on the basis of a short laboratory visit and the exchange of a few publications. On one side of the ledger the individuals carrying out the experiments were physicists, well respected in their own fields, and using standard techniques and procedures familiar to them. Such factors, coupled with the degree of official sanction that exists, tend to lend de facto credibility to their claims. On the other side of the ledger, however, details as to countermeasures against the possibility of fraud, methodological procedures used, and the statistical treatment of the data are notably lacking in the brief publications to date, a weakness noted in general in the response of Western scientists to published reports on EHSF work by the Chinese.<sup>14</sup> Definitive conclusions as to the technical quality of the work must therefore await further development of information exchange.

C. Shanghai Meeting with Editorial Staff of 'Nature' ('Ziran Zazhi') (U)

(U) Later in the trip the group of Western parapsychologists met at length over a two-day period with the staff and Editor-in-Chief, Mr. He Chongyin, of Nature (Ziran Zazhi), and from them obtained an overview of the experimentation, results, conferences and publication of the Chinese efforts. It was clear from these discussions that the Nature group played a seminal role in bringing together researchers in the Shanghai and Chongqing conferences of 1980 and 1981, and in providing space in their journal for the publication of results.

(U) In addition to discussion, an hour of filmed EHSF research was shown. The film, made by Shanghai Science and Education Studio for television distribution within the PRC, showed a wide-ranging series of investigations, including mass screening of schoolchildren with regard to the capacity to "skin read," standard telepathy/clairvoyance tests over room-to-room distances, apparently successful "dowsing" to locate buried

**UNCLASSIFIED**

**UNCLASSIFIED**

(U)

cisterns, the Institute of High-Energy Physics experiments on the detection of EHBf radiation, and attempts to apply EHBf techniques as tools in medical diagnosis and healing.

(U) Generally speaking, the observations reported are in accord with what has been reported in the West. Specifically, from the work that had gone on, the Chinese concluded that

- Extraordinary human body functions do exist, and they include in addition to the skin reading phenomenon first observed, other classical psychoenergetics functions such as telepathy, clairvoyance, and psychokinesis.
- EHBf appears to be a universal inherent, though latent, function in all humans (based on Beijing University studies on induction of the phenomena in children).
- EHBf phenomena are not shielded by materials such as paper, plastics, the human body, layers of soil, and metal, and so resist interpretation in terms of the present scientific paradigm.
- EHBf "perception" extends beyond the visible range into the infrared and ultraviolet portions of the electromagnetic spectrum, and the sign of magnetic fields can be discriminated.
- Power levels on the order of 100 mW can be generated in EHBf functioning, as determined by psychokinesis experiments.
- There appear to be interrelationships between EHBf functioning and elements of traditional Chinese concepts, as evidenced by shifts in dermal temperature and electrodermal potential at acupuncture joints, interference with or strengthening of EHBf by qigong\* meditational techniques, and the like.

---

\* (U) Pronounced "chigong," an ancient system of deep breathing and movement exercises said to promote health and well being.

**UNCLASSIFIED**



**UNCLASSIFIED**

(U)

- The use of EHSF phenomena in Chinese hospitals was found to be somewhat effective as a tool in medical diagnosis, and in helping the blind to sense their environment.
- Several of China's well-known scientists have involved themselves in the increasing activity in psi studies, including H. S. Tsien, Bei Shi-Zhang, Zhao Zhong-Yao, Wang Gan-Chang, Wang Da-Heng and Tan Ja-Zeng.

(U) In the above list, H. S. Tsien,<sup>\*</sup> who has been a driving force behind establishing EHSF science, is singled out as an individual who has played a key role in legitimizing the investigation of EHSF in China. Tsien is one of China's most respected scientists in the field of military rocketry, and is thought to have had a major role in developing China's first nuclear bombs. Before emigrating to China from the United States in 1955, he was Goddard Professor of Jet Propulsion at Caltech and Director of the Rocket Section of the U.S. National Defense Scientific Advisory Board. At Caltech he was well known to Richard D. Delaur, now Undersecretary of Defense for Research and Engineering, who characterizes Tsien as an "elder statesman" in China's scientific development.

D. PRC Representation at Cambridge Conference (U)

(U) Each August the Parapsychological Association (PA) holds its annual conference, where about 150 professionals meet over a three-to-four-day period to present papers and exchange research information. In 1982 the PA meeting was cosponsored by the British SPR (Society for Psychical Research) and held at Trinity College, Cambridge, England, as the Centenary Conference to commemorate the founding of the SPR 100 years ago in 1882. To parapsychologists in the West, the 1882 date in a certain sense marks

---

\* (U) Qian Xue Sen in Pinyin transcription.

**UNCLASSIFIED**

**SECRET**

(U)

the beginning of formal investigation of psychoenergetic phenomena by the scientific/academic communities.

(U) In preparation for that conference, one of those involved in the China tour, Dr. H. E. Puthoff of SRI International, chaired a special session on the Chinese work. Puthoff sent invitations to several of the leading Chinese scientists, met on the China tour, to attend the conference and report on their progress. Of those invited, none were permitted to attend. In their place, the PRC government sent to the conference two highly placed scientists to represent the Chinese work. They were Chen Hsin<sup>\*</sup> and Mei Lei, both Deputy Directors at the Institute of Space Medico-Engineering, P.O. Box 5104, Beijing, an institute of over two decades standing, the last 15 years under the present name.<sup>†</sup>

(U) Hsin and Lei reported that they were involved with the PRC space physiology program. There, as neurophysiologists, they are studying various techniques to combat space sickness, including biofeedback training (of the type employed by NASA for their astronaut training program) and the use of meditational/breathing exercise/martial art techniques from their qigong martial art tradition. Because the latter are said to enhance spontaneous EHBF abilities, their involvement in EHBF studies evolved from this source.

(U) They reported their present involvement includes research efforts in their own institute, and their funding and monitoring of research outside the institute, all under the administrative leadership of Hsin, who, in addition to being Deputy Director of the Institute of Space Medico-Engineering, is also Chairman of the Space Medico-Engineering Professional

---

\* (U) Chen Xin in Pinyin transcription.

**SECRET**

**SECRET**

(U)

Committee of the Chinese Society of Astronautics, and Chairman of the Space Life-Science Professional Committee of the Chinese Society of Space Research. The day-to-day technical aspects of the program at the Institute of Space Medico-Engineering appear to be under the leadership of Deputy Director Mei Lei, who is also a member of the Space Life-Science Professional Committee of the Chinese Society of Space Research. Professor Lei's professional expertise lies in the area of EEG brainwave measurement, an area in which he has published<sup>15</sup> and appears to be completely knowledgeable by Western standards.

SG1B

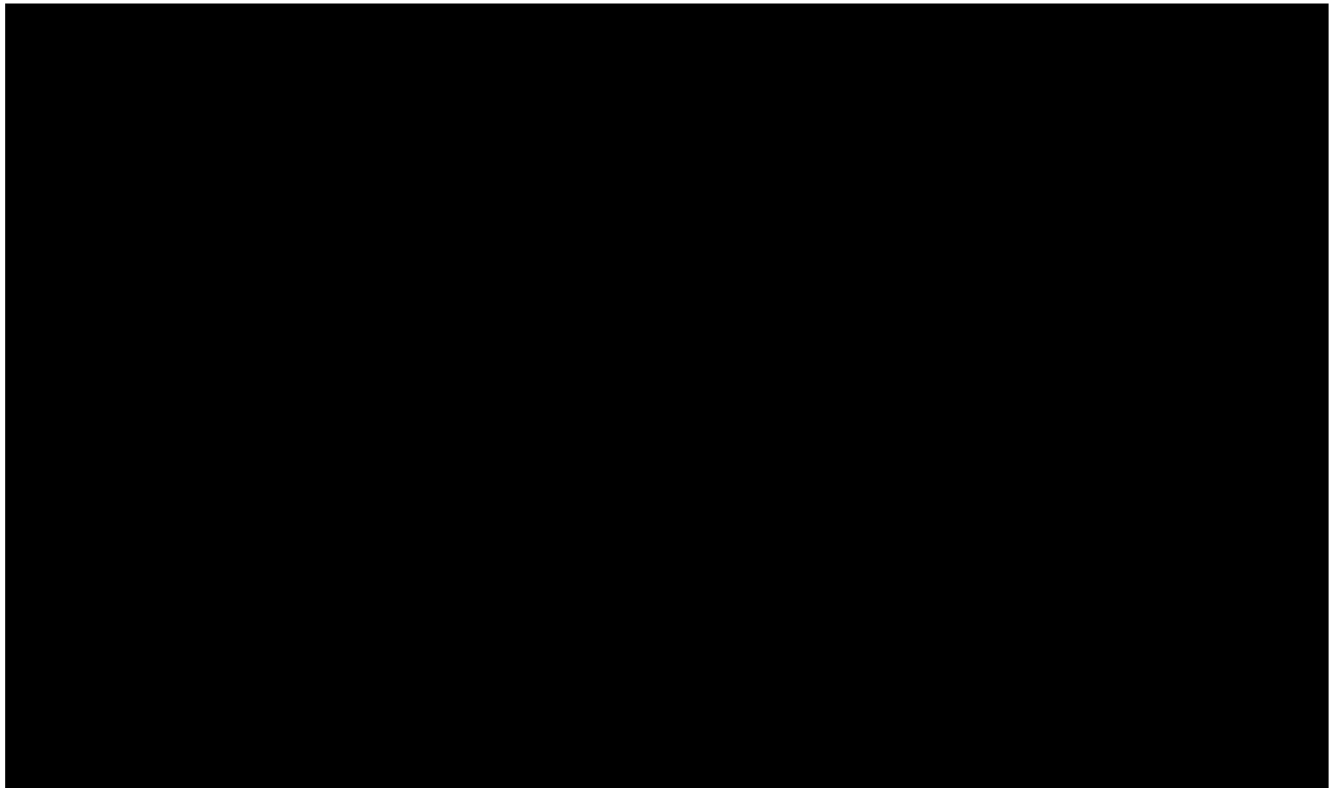

(U) In their paper presented at the conference, included here as Appendix B, the PRC effort was described as wide ranging, serious, multi-disciplinary and sophisticated in methodology with regard to countermeasures against fraud, the need for double-blind conditions, high-technology recording of results and statistical evaluation. A partial bibliography

**SECRET**

**UNCLASSIFIED**

(U)

summarizing the Chinese work on EHBFB is included here as Appendix C, and a list of researchers and institutions actively involved in EHBFB work is given in Appendix D.

**UNCLASSIFIED**

**UNCLASSIFIED**

THIS PAGE INTENTIONALLY LEFT BLANK

**UNCLASSIFIED**

**UNCLASSIFIED**

## III ASSESSMENT AND CONCLUSIONS (U)

A. Assessment (U)

(U) The 1979-present period has seen a rapid mobilization of interest and resources in the PRC in pursuit of EHF (psychoenergetics) research. In this short period large segments of the population have been screened and a number of individuals identified as possessing EHF skills.

(U) The skills cataloged are essentially identical to those gleaned by studies in the West and in the Soviet Union: various forms of acquisition of information that would appear to be inaccessible by normal sensory means because of such factors as distance and shielding (e.g., identifying written Chinese characters sealed in a box), and, to a lesser degree, the generation of small-scale physical effects (e.g., the fogging of film). There are, however, certain differences in research directions that reflect their scientists' efforts to correlate research findings with certain distinctively national Chinese concepts. These include the search for electrophysiological correlates of EHF functioning at acupuncture points, and the possible relationship between EHF and qigong meditation/martial art practices. Through exploring these rich historical traditions scientifically, the Chinese scientists may well contribute fresh ideas to the study of exceptional human functioning.

(U) As short as the 1979-present period of intense effort has been, focus on the phenomena has moved quickly from the media to the universities (e.g., Beijing and Yunnan Universities), research institutes of the Chinese Academy of Sciences (e.g., Institute of High-Energy Physics), and to the national laboratories involved in space/military research (e.g., Institute of Space Medico-Engineering, and an unnamed Air Force Institute<sup>16</sup>).

**UNCLASSIFIED**

**SECRET**

(U) Although information available to the West is insufficient at the present time to assess with confidence the actual quality of research (and, indeed, there is evidence that some of the early work was relatively naive by Western standards), the signs of increasing research activity and steps toward legitimization and official sanction indicate steady progress at a relatively rapid rate.

SG1B

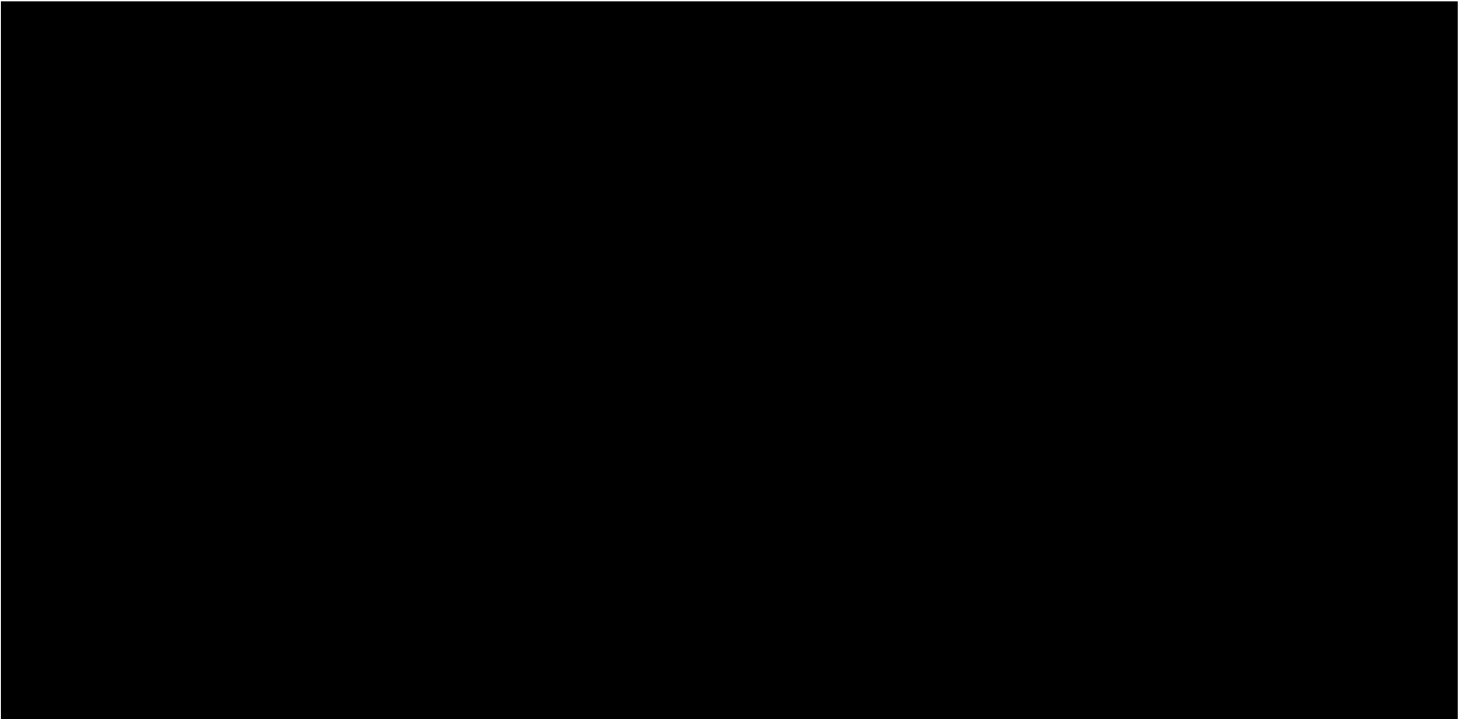

B. Conclusions (U)

(U) As a result of the information discussed in this report the following conclusions can be drawn concerning PRC activities in the psychoenergetics field:

- (1) (U) There has been a rapid escalation of research activity since 1979.
- (2) (U) Reported research results parallel those reported in the West.
- (3) (U) Signs of increasing acceptance and legitimization include

**SECRET**

**SECRET**

(U)

- Continuing publication of research results in a major monthly scientific journal, Nature (Ziran Zazhi).
  - EHBFB entry in 1981 China Encyclopedic Almanac.
  - Permission granted Western parapsychologists to tour China to meet with Chinese counterparts.
  - PRC officially represented at international parapsychology conference (P.A./S.P.R. Centenary Conference, Cambridge, England, 1982) by two high-level scientists actively engaged in EHBFB work in a leading national laboratory (Institute of Space Medico-Engineering).
- (4) (U) Field has high-level scientific and political support, indicated by
- Leadership role taken by military rocket expert Tsien
  - Statement of support by Secretary-General of the Chinese Communist Party, Hu Yao-pang.
- (5) (U) Active research pursued at national-level space science (Institute of Space-Medico Engineering) and military (unnamed Air Force Institute) laboratories, in addition to major universities (e.g., Beijing, Yunnan) and Chinese Academy of Science laboratories (e.g., Institute of High-Energy Physics).

SG1B

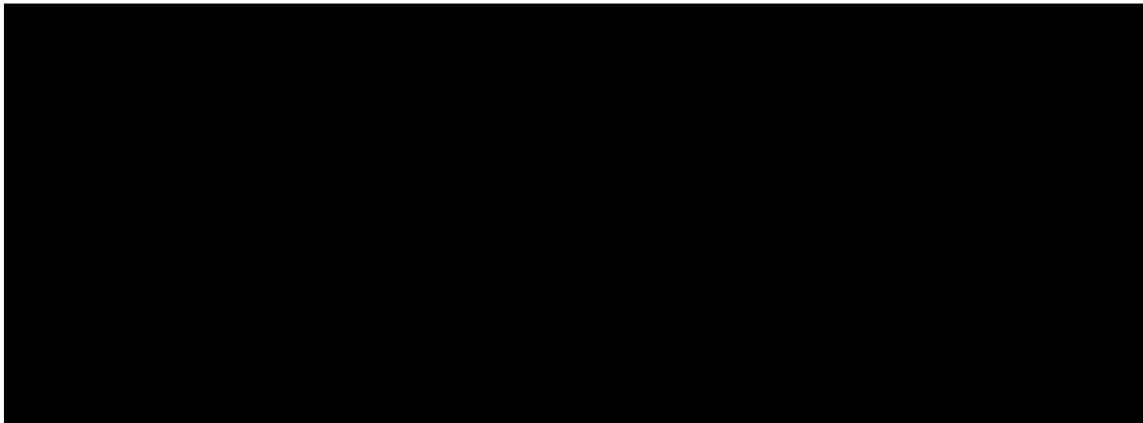

**SECRET**



**UNCLASSIFIED**

THIS PAGE INTENTIONALLY LEFT BLANK

**UNCLASSIFIED**

**UNCLASSIFIED**

## REFERENCES (U)

1. Hsin Ping, "The Rampancy of Parapsychology and the Decline of the Superpowers," Scientia Sinica (July-August 1975).  
See also discussions by M. Ebon, "Peking Journal Denounces Telepathy Studies," Parapsychology Review, November-December 1975; "Parapsychology in Contemporary China," Parapsychology Review (September-October 1981).
2. Reporter, Nature Journal (Ziran Zazhi), "Observation Report on the 'Non-Visual Recognition of Images,'" Nature, Vol. 2, No. 9 (September 1979).
3. Chen Shouliang and He Muyan, "Findings Concerning One Type of Extraordinary Function of the Human Body," Nature, Vol. 2, p. 715 (1979).
4. Xu Zifang et al., "Observations Concerning the Ear's Ability to Recognize Characters and Distinguish Colors," Nature, Vol. 2, p. 716 (1979).
5. He Dahua et al., "Observations Concerning Tang Yu's Ability to Distinguish Colors and Recognize Characters with the Ear," Nature, Vol. 2, p. 780 (1979).
6. Chen Shouliang et al., "The Decline and Restoration of Jian Yan's Extraordinary Body Functions," Nature, Vol. 2, p. 781 (1979).
7. Jules Romains, Eyeless Sight (reprinted by Citadel Press, Secaucus, N.J., 1978).
8. I. M. Gol'dberg, "On Whether Tactile Sensitivity Can be Improved by Exercise," Soviet Psychology and Psychiatry, Vol. 2, No. 1 (Fall 1963).
9. Zhen She, "Parapsychology, Is It Real?" China Reconstructs, Vol. 30, No. 1, pp. 50-51 (January 1981).
10. Document No. FTD-ID(RS)T-1766-80, Translation Division, Foreign Technology Division, Wright-Patterson AFB (January 1981).
11. China Reconstructs, Vol. 31, No. 6, p. 51 (June 1982).

**UNCLASSIFIED**

UNCLASSIFIED

12. R. D. Fowler, "Travels in China," Psi Chi Newsletter of the National Honor Society in Psychology (Spring 1981).
13. Zhao Yun-Je, et al., Special Physics Research Team, Institute of High Energy Physics, "Exceptional Human Body Radiation," Psi Research, Vol. 1, No. 2, pp. 16-25 (June 1982).
14. J. C. Shum, "Reading Without the Eyes--Report from China," Bull. Brit. Psych. Soc., Vol. 34, pp. 125-126 (1981).
15. Mei Lei et al., "Brain Wave Analysis in the Qigong State," Nature, Vol. 4, No. 9, p. 662 (September 1981).
16. Luo Dongsu, "Discussion of Non-Visual Recognition of Images and the Electromagnetic Sensor Mechanism in the Human Body," Document No. FTD-ID(RS)T-1766-80, Translation Division, Foreign Technology Division, Wright-Patterson AFB (January 1981).

UNCLASSIFIED

**UNCLASSIFIED**

Appendix A

EXCEPTIONAL HUMAN BODY RADIATION

Special Physics Research Team  
Zhao Yun-Je et al.  
Institute of High-Energy Physics  
Chinese Academy of Sciences  
Beijing

**UNCLASSIFIED**

**UNCLASSIFIED**

THIS PAGE INTENTIONALLY LEFT BLANK

**UNCLASSIFIED**

UNCLASSIFIED

CPYRGHT

Appendix A

EXCEPTIONAL HUMAN BODY RADIATION

Special Physics Research Team  
Zhao Yun-Je et al.  
Institute of High-Energy Physics  
Chinese Academy of Sciences  
Beijing

The fact that the human body can develop the ability of exceptional vision (eyeless sight) suggests that in the natural world there may exist a unique, still unknown radiation. Since 1979, Szechuan Ribao, Beijing Keji Bao (Peking Science Report), Ziran (Nature), and other journals have published findings on exceptional capabilities of the human body. Using available techniques, we have conducted complex experimental research relating to methods of testing and measuring such unknown radiation. Among these techniques, the most effective are the following:

- (1) Tests with nuclear emulsion film and X-ray film
- (2) Tests with thermoluminescent film
- (3) Tests with a biodetector
- (4) Tests with a light quanta detector.

Exceptional human capabilities can manifest as various types of phenomena. We realize that only by finding a precise, objective basis, and by gradually establishing controlled test methods, can we bridge research in exceptional human capabilities and present experimental science. Only then can we delineate the frontier between science and superstition.

UNCLASSIFIED

**UNCLASSIFIED**

CPYRGHT

**TESTS OF "EXCEPTIONAL VISION"  
WITH NUCLEAR EMULSION FILM**

In nuclear and particle physics research, testing with film is one of the most reliable and convenient ways of detecting natural radioactivity, the presence of pi-mesons, K-mesons,  $\Sigma$ -hyperons, and other particles.

According to initial tests, the majority of persons with "exceptional vision," while exercising their capability, could expose film sealed in a light-proof container with Chinese characters which the subject was attempting to identify. Over 700 tests with X-ray film, over 50 tests with nuclear emulsion film, and numerous tests with ordinary photographic film were conducted. These experiments demonstrated that when the subjects who possessed "exceptional vision" correctly recognized the characters, they simultaneously produced exposures of the film placed near the characters as well as other unusual effects. Occasionally they were even able to project images of the characters onto the nearby film (Figures 1 and 2).

When a microscope was used to observe unusual exposures of a nuclear emulsion film produced by Yu, an individual with "exceptional vision," it was found that most of the silver grains removed from the membrane had accumulated in a surface layer of 0 to 10  $\mu$ . The maximum depth was about 30  $\mu$ . The vertical distribution of silver grains indicated that the influence of unknown radiation is similar to the effect of visible light, but the penetration of this unknown radiation is somewhat deeper into the emulsion.

Thorough inspection of the container used for the film test, of the testing methods, and of the brush and paper (for writing the characters), excluded known types of radiation, fluorescence, chemical interactions, light leaks or radioactive decay from producing the observed effect. Comparison of selected containers of different shapes and materials in various experimental conditions led to the following conclusions:

**UNCLASSIFIED**

**UNCLASSIFIED**

CPYRGHT

- (1) This unknown radiation, when compared to known types of physical radiation, manifests a more complicated spatial distribution.
- (2) The radiation has unusual penetrating power and selectivity. Only when near the recognized target characters, does it produce effects resembling the physical effects of visible light, while in other areas its impact is near zero.

TESTS OF "EXCEPTIONAL VISION"  
WITH THERMOLUMINESCENT FILM

The use of thermoluminescent film for measuring radioactivity is one of the most appropriate and sensitive methods. It is widely used in nuclear medicine as well as in environmental and personal dosimetric observation.

Figure 3 shows statistical results of preliminary tests with thermoluminescent film, obtained from approximately 4000 experiments in the exceptional-vision process. During these tests, influences of infrared, magnetic, and chemical factors, and even of solar activity, were compared to the influence of "exceptional vision" and eliminated. The test results have shown:

- (1) When individuals with "exceptional vision" exercise their capability, they can influence thermoluminescent film, placed near the recognized characters,  $10^2$  to  $10^3$  more than is observed in control tests (i.e., without the attempted influence of any individual).
- (2) When individuals who do not manifest exceptional capabilities attempt to exert the influence on the same sort of samples, they also can produce a response on thermoluminescent film many times greater than in control tests.
- (3) When exceptional individuals were tested in their usual state, i.e., when not exercising their special capability, the response of thermoluminescent film

**UNCLASSIFIED**



UNCLASSIFIED

was not clearly different from that produced by normal individuals. The design of the thermoluminescent film test resembles that of the test with photographic film. Results of these tests partially confirm the results of the photographic film tests and provide a quantitative basis for some initial measurements. They not only show that during "exceptional vision" a strong unknown radiation is emitted, but also show that normal persons emit a relatively low, unknown radiation as well.

(U) For these tests we used American film, made by the Harshaw Chemical Company: 6LiF, 7LiF, CaF, and Chinese film LiF (Mg, Ti). A thermoluminescent dosimetric analyzer produced by the Beijing Synthetic Apparatus Plant (Model FL-369) was used for evaluating results.

#### TESTS OF UNKNOWN RADIATION WITH A BIODETECTOR

The greatest disadvantage of photographic and thermoluminescent film tests is their failure to show kinetic response (changes in time), so that there is no way to study the delicate time specificity of unknown radiation.

Both the biodetector and the light-quanta detector can demonstrate kinetic responses in a test system, but the various types of biodetectors provide more possibilities for experimentation. We have already used a set of simple biodetectors for measuring bioelectric changes in a plant leaf vein (Figure 4). Yet, because the main component of the biodetector is a living system (a plant leaf),\* we cannot expect that the system has sufficient stability. Nevertheless, because the degree of sensitivity obtained from this method is significant, and because it is relatively widespread and easy to operate, it will certainly arouse the interest of many researchers.

\* See Zhao Yongjie, Xu Hongzhang, et al., "Biodetector Experiments on Human Body Radiation Physics," Psi Research, Vol. 1, No. 1. pp. 77-84 (March 1982).

UNCLASSIFIED

**UNCLASSIFIED**

CPYRGHT

The system can sensitively record the impact of unknown radiation related to the exceptional-vision process as well as indicate impulses (Figure 5) caused by unknown radiation from normal individuals trained in exceptional abilities. However, when compared with the responses obtained in the exceptional-vision process, in the latter case the waveform of responses is different (Figure 6). The other radiation sources used (heat source, infrared light, and visible radiation), when influencing the biodetector, did not elicit responses of comparable sensitivity. Because moisture and chemical effects produced different responses, they were eliminated as possible causes.

#### TESTS OF UNKNOWN RADIATION WITH A LIGHT-QUANTA DETECTOR

The light-quanta detector overcomes the drawbacks of the biodetector, i.e., its lack of stability. It yields virtually the same results as the biodetector tests, although its degree of sensitivity may be insufficient for studying trained abilities. (For a design of the system see Figure 7.) The system, however, is equally sensitive with regard to visible light, near infrared, and near ultraviolet. At a wavelength of  $4,400 \text{ \AA}$ , the peak value of photon efficiency is about 20 to 30 percent. The system is also sensitive to electrons above the megaelectron-volt level, such as from a  $\text{Sr}^{90}$  beta source.

Our oscillographic observations, shielding, adequate grounding, and other measures eliminated the possibility of interference from environmental magnetic impulses. We simultaneously eliminated conditions for light leaks and wear and tear during the tests.

Our tests have demonstrated that the system produced very strong impulse responses to the processes accompanying "exceptional vision." The leading edge of such impulses is extremely steep; the count value is

**UNCLASSIFIED**

**UNCLASSIFIED**

CPYRGHT

at least  $10^2$  to  $10^3$  times more than the system's control value. The value of a plotter suddenly rose within a second from 1000 to 10,000 counts, while the control value was  $80 \pm 20$  counts every 6 s. Such a high-value ratio usually causes a multichannel analyzer to generate overload blocking. Individuals with "exceptional vision" must touch the surface of the light-proof material (many layers of black cloth), or their radiation will be outside of the "measuring area." All these factors obscure the above results to a certain extent, although these results do agree with the findings pertaining to the width of permeability and fixed-area selectivity yielded by the film tests. It is hard to imagine that ordinary photons or electrons could penetrate such material, reach the photocathode, and thus be recorded.

This system can also elicit a corresponding response to unknown radiation produced by normal persons exercising their trained abilities. Yet, compared to the special-vision process, the oscillation of their response signals will be much slower, and the intensity of pulsation much lower. Study of the spectrum of rise or fall of the count pulses in such responses demonstrates that the response spectrum of the unknown radiation coming from the exceptional vision process contains a maximum of high-amplitude count pulses. The trained-ability spectrum contains almost no high-amplitude count pulses (Figure 8).

#### DISCUSSION AND CONCLUSION

The above four test methods, while still very rudimentary, are relatively basic and can be duplicated. Their results are mutually confirmatory and supplement one another. The first steps have proven that, in the natural world, there exists an unknown radiation that is reciprocally connected with the life process. Compared with generally known physical radiation, this radiation has a more complex distribution in space and time. When recorded by the biodetector or photon detector, it demonstrates

**UNCLASSIFIED**

**UNCLASSIFIED**

an impulse waveform with a rather steep leading edge. Its pulsation intensity is at least 100 to 1000 times more than in control tests. There are no fixation periods.

This radiation possesses a special penetrative ability and fixed-area sensitivity. Near target objects it has the effect of visible light. It has a physical basis resembling that of unknown radiation during the trained-ability activity of normal persons.

We hope that our first steps will lead to more progress in research.

#### REFERENCES

1. Yongjie, Zhao, et al., "Detecting 'Radiation' from 'Specially Trained' Persons Using a Quantum Count System," Dienzi Kexue Jishu (Electronic Technology) (1981).
2. Hongzhang, Xu, et al., "Initial Research on Special Radiation," Heyiqi yu Fangfa (Nuclear Apparatus and Methods) (1981).
3. Puthoff, H., Targ, R., "Physics, Entropy, and Psychokinesis," Quantum Physics and Parapsychology, Parapsychology Foundation, New York, NY (1974).
4. Eisenbud, J., The World of Ted Serios, Morrow, New York, NY (1967).
5. Eisenbud, J., "Distortions in the Photographs of Ted Serios," Journal of the American Society for Psychical Research, Vol. 75, pp. 43-152 (1981).
6. Hasted, J. B., "Paranormal Electric Effects," Journal of the Society for Psychical Research, Vol. 51, pp. 75-86 (1981).
7. Miller, R., "The Energies of Spiritual Healing," Science of Mind (January-February 1976).

**UNCLASSIFIED**

UNCLASSIFIED

CPYRGHT



图1: 特异视觉人王×在X光胶片上产生的局部感光及投影“920”

FIGURE 1 "EXCEPTIONAL VISION" PERSON WANG. Photographic exposure and projection of the number "920" onto X-ray film.

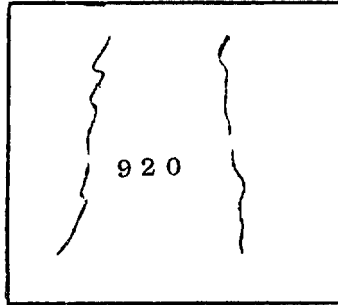

图2: 特异视觉人于×在核乳胶片上产生的局部感光及投影“电工”

FIGURE 2 "EXCEPTIONAL VISION" PERSON YU. Photographic exposures and projection of the characters "dian gong" on nuclear emulsion film.

UNCLASSIFIED

UNCLASSIFIED

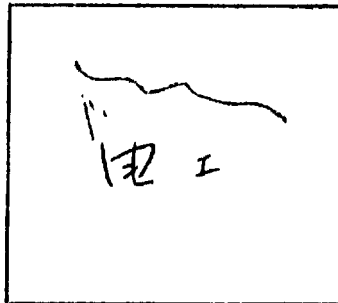
CPYRGHT

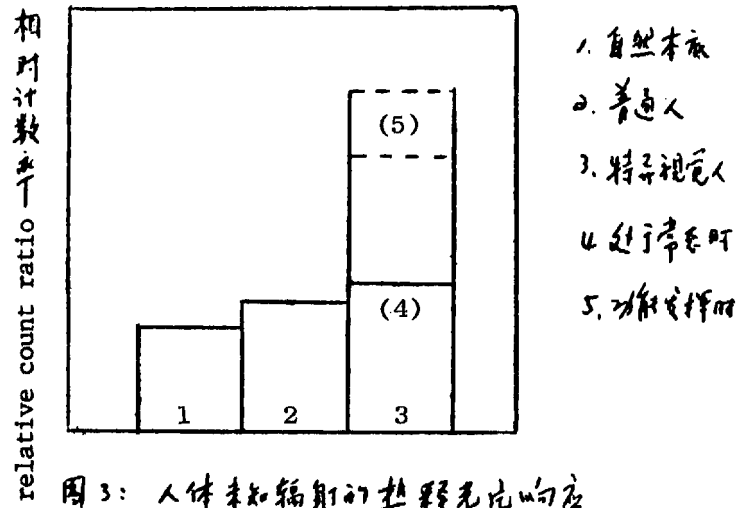

FIGURE 3 RELATIVE RESPONSE OF THERMOLUMINESCENT FILM TO UNKNOWN HUMAN BODY RADIATION. (1) Control film, (2) Ordinary person, (3) "Exceptional vision" person, (4) During usual condition, (5) While exercising the ability.



图4: 一种生物探测系统示意图, 其中 1. 受试人; 2. 字样; 3. 容器; 4. 示波器; 5. 记录仪

FIGURE 4 DESIGN OF THE BIODETECTOR SYSTEM. (1) Subject, (2) Image of Chinese character, (3) Container, (4) Oscillograph, (4) Recorder.

UNCLASSIFIED

UNCLASSIFIED

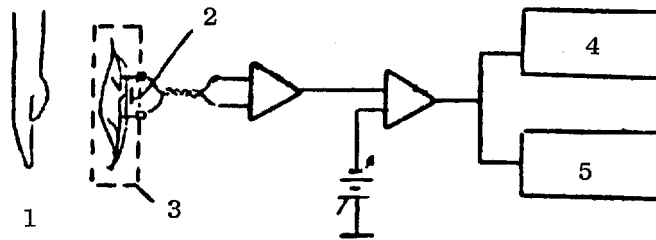
CPYRGHT



图5: 特异视觉过程的生物探测响应

FIGURE 5 SYSTEM FILM. (a) Beginning, (b) Concentration of attention, (c) "Brain cell flashes", (d) Release, (3) Removal of hand.

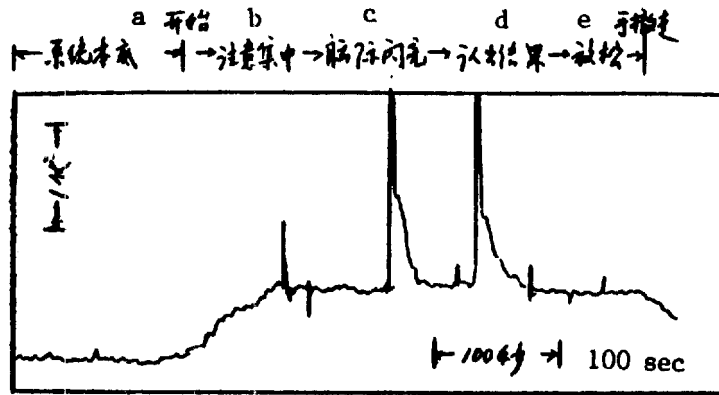

图6: 气功师气的生物探测响应 (练习气功)

FIGURE 6 SUBJECT SHEN WITH TRAINED EXCEPTIONAL ABILITIES (USING QIGONG SYSTEM). Response of the biodetector: 0 = exercise of trained ability, S = end of exercising trained ability.

UNCLASSIFIED

UNCLASSIFIED

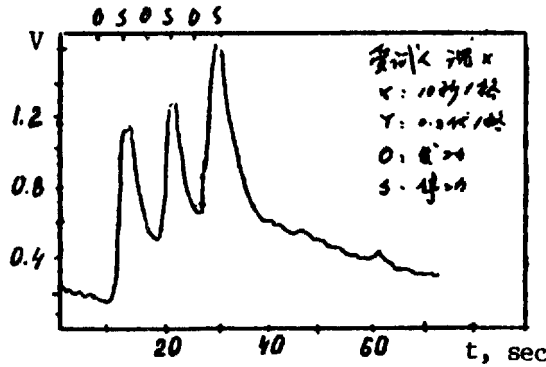
CPYRGHT



图7: 光量子探测器系统示意图。

FIGURE 7 DESIGN OF LIGHT QUANTA DETECTOR SYSTEM. (1) Subject, (2) Photo-multiplier tube, (3) High voltage, (4) Potentiometer, (5) Recorder, (6) Image for recognition, (7) Light shield, (8) Electric shield, (9) Single channel analyzer, (10) Plotter, (11) Oscillograph, (12) Multichannel analyzer.

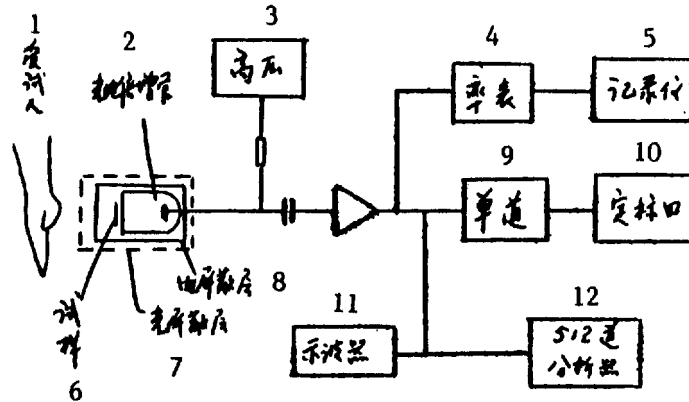

图8: 人体未知辐射的计数脉冲幅度谱

FIGURE 8 IMPULSE AMPLITUDE SPECTRUM OF UNKNOWN HUMAN BODY RADIATION. • = natural film, ▲ = unknown radiation produced by a person with trained ability (Shen), + = unknown radiation produced during exercise of "exceptional vision" ability.

UNCLASSIFIED

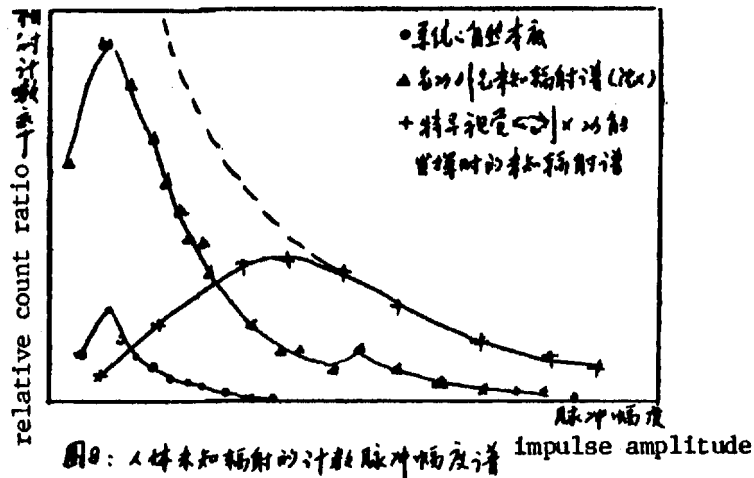

**UNCLASSIFIED**

THIS PAGE INTENTIONALLY LEFT BLANK

**UNCLASSIFIED**

**UNCLASSIFIED**

Appendix B

STUDY OF THE EXTRAORDINARY FUNCTION  
OF THE HUMAN BODY IN CHINA

Chen Hsin and Mei Lei  
Space Medico-Engineering Institute  
Beijing, China

**UNCLASSIFIED**

**UNCLASSIFIED**

THIS PAGE INTENTIONALLY LEFT BLANK

**UNCLASSIFIED**

UNCLASSIFIED

CPYRGHT

Appendix B

STUDY OF THE EXTRAORDINARY FUNCTION  
OF THE HUMAN BODY IN CHINA

Chen Hsin and Mei Lei  
Space Medico-Engineering Institute  
Beijing, China

ABSTRACT

In the Spring of 1979, a boy in Sichuan Province, China, was discovered to be able to "recognize characters (ideograms) with his ears." This attracted the attention of Chinese scientists. A series of investigations were carried out thereafter on the extraordinary function of the human body, including "reading without using the eyes." Preliminary results obtained during the past three years are presented, and the perspective on future research in this field are discussed.

Entrusted by the Chinese scientists who have engaged in research on the extraordinary function of the human body, the writers of the present paper will report on their concepts and efforts at this international congress. The Chinese scientists' attitude towards the study in this field was serious, and they have made every effort to ensure that their investigations fulfill the criteria of scientific research.

1. General Background

On 11 March 1979, it was reported for the first time in Sichuan Ribao that a 12-year-old boy, Tang Yu, in Dazu County, Sichuan Province, had been discovered to be able to "recognize the characters (Chinese ideograms) with

UNCLASSIFIED

**UNCLASSIFIED**

his ears." This evoked strong repercussions at home and abroad. Consequently, more than ten teenagers who also had this kind of function were discovered one after another in Beijing, Anhui, Hubei, and other places. In September 1979, Nature Journal (Ziran Zazhi) carried a report on "Nonvisual Pattern Recognition" written by a correspondent of the journal on the basis of his personal observation. This article confirmed that the exceptional function of the human body, or, as it was depicted in the newspapers, "recognizing the characters with ears," actually existed and is worth studying. The journal then, in its issues Numbers 10 through 12 carried in succession other experimental observations<sup>1-4</sup> by scientists of Beijing University, Anhui Teachers University, and other units, which verified the authenticity of the function.

In February 1980, in Shanghai, the Nature Journal editorial department presided over the "First Science Symposium on the Extraordinary Function of the Human Body," attended by representatives from eight provinces and three municipalities. After this the various exceptional functions of the human body, including "recognizing the characters with ears," became generally known as the "extraordinary function of the human body," which is now the general term being used in the Chinese literature.

With the impetus of the symposium, the research work has developed further in various places, and in May 1981, the "Second Science Symposium on the Extraordinary Function of the Human Body" was held in Chongqing. Some famous scientists submitted their papers<sup>5</sup> and many others read their research reports at the symposium. Diverse thoughts from different schools were incorporated, but no conclusion was drawn at the symposium. Before the end of the symposium the Preparatory Committee of the Chinese Human-Body Science Institute was set up after deliberation and consultation. Afterwards, in January, 1982, the preparatory committee convened a special discussion in physics.

**UNCLASSIFIED**

**UNCLASSIFIED**

The China Encyclopedic Almanac of 1981, published by the China Great Encyclopedia Press, has the vocabulary entry "extraordinary function of the human body" in its column on science and technology, which introduces the development of the study of the extraordinary function of the human body in China,<sup>6</sup> and also points out that "there are still some people holding sceptical attitudes with respect to the authenticity of the extraordinary function of the human body."

## 2. Studies of Chinese Scientists

During the past three years, the Chinese scientists have carried out experimental studies on the aspects described below.

Under strictly controlled experimental conditions, the authenticity of the special inductive function of the human body, such as "recognizing the characters with the ears" was verified. To rule out possible artifacts as well as false results, and to ensure the level of scientific rigor, while continually improving the experimental methods, the experiments have been designed in keeping with the following requirements:

- (1) A specimen ("target" for recognition and its package) has to possess certain characteristics of "uniqueness" to ensure that it not be duplicated and exchanged in designed experimental conditions.
- (2) The "target" for recognition has to be sealed in "opaque" and "irreversible" forms, so that, under the designed experimental conditions, if the package is opened it will be destroyed and cannot be completely restored; if it is not opened, the "target" in it cannot be recognized with ordinary sight.
- (3) Both the experimenters and the subject should be unaware of the content of the "target" to ensure "double blind" conditions and to avoid hints (cues).
- (4) Reliable on-the-spot observation by more than one person or by a videorecorder, which can be replayed for examination, or both.

**UNCLASSIFIED**

**UNCLASSIFIED**

- (5) The possibility of "guess by chance" should be ruled out statistically from the experimental results; in other words, the results should have "statistical significance."

Under these strict experimental conditions, some subjects whose functions were stronger were tested with dozens of specimens. The rate of absolutely correct identifications was more than 80 percent,<sup>1,7</sup> which indicated that one of the special inductive functions, the so called "recognizing the characters with the ears," existed objectively.

Scientists in Beijing University further found in experiments that among over 70 children aged about 10, a considerable proportion of subjects had the special inductive function of "recognizing the characters with the ears."<sup>8,9</sup> They concluded that this kind of function may be a general phenomenon to a certain extent among children in the relevant age group and inferred that this function was probably a potential physiological function of the human body. The "universality" discovered thus far further verified the authenticity of the extraordinary function of the human body and provided more subjects for research work.

Our experimental results also indicated that although the subjects who had the extraordinary function were not rare, there were few who had a stable strong function over the long term. In some conditions, the experimental results could be "reproduced," but they were not as "repeatable" on demand as in ordinary physical and chemical experimentation. They often showed apparent individual differences, and an undulating "instability" in the case of one subject.

As some researchers reported, apart from "recognizing characters with the ear," the human body may possess many other extraordinary functions. The researchers have searched after and observed such functions as psychokinesis, teleportation, and the like. Recording the equivalence-time curve of moving the hands of a watch by the extraordinary function of the human body, and observing the possibility of transferring a specimen out of a

**UNCLASSIFIED**

**UNCLASSIFIED**

container from a hole smaller than the specimen itself by this kind of function are two examples.<sup>10, 11</sup>

Some researchers have also carried out experimental investigations to determine the mechanism of the human body extraordinary function. The main efforts in this respect are as follows:

The study of the special properties of the information carrier and human body radiation: To begin with, the "target" was sealed into a container made of different materials and in which there are different-size slits. Then tests were carried out so as to find out the effect of the differences in shielding materials and the size of the slits on the test results, thereby distinguishing some special properties of the information carrier. On the other hand, the corollary human body radiation of a subject in an extraordinary functional state was tested by the use of modern technology. The published papers on this subject include the effect of human body radiation on biodetectors and photon counters<sup>12, 13</sup> and on some phototransistor detectors,<sup>14</sup> as well as the determination of the magnetic field distribution over an individual subject's body surface.<sup>15</sup>

Experiments involving irradiation of the ears, hands and other sites of a person who has extraordinary functions with weak monochromatic light from a spectrometer confirmed that in these sites there existed an ability to perceive and distinguish the color of visible light,<sup>16</sup> and that persons who have extraordinary functions could perceive near-infrared light as well.<sup>17</sup> Experiments also confirmed that such persons could distinguish the north pole from the south pole of a magnet<sup>15</sup> and could tell north from south by their extraordinary functions.<sup>18, 19</sup> Some researchers have also carried out experiments to investigate the image transfer function under bright-contrast stimulus conditions,<sup>20</sup> the perceptibility of an optical image in space,<sup>21</sup> and the sensitivity to different light waves.<sup>22</sup>

The study of the property of information processing and display: The published papers<sup>23-27</sup> showed that during the process of recognizing targets by means of the special inductive function of the human body the following

**UNCLASSIFIED**



**UNCLASSIFIED**

CPYRGHT

characteristics of perception have been experienced by the subjects: unfolding, enlarging, recognizing layer by layer, selecting by contrast, displaying step by step, and adjusting directions automatically.

We consider, however, that experimental research on the extraordinary function mechanism are preliminary, and that they need further replication and deepening. On the basis of the experimental investigations, some researchers in China have made preliminary inquiries into the extraordinary function mechanism of the human body from a theoretical standpoint.

Information concerning the human body extraordinary function as recorded in the ancient Chinese literature is now beginning to be collected for evaluation.<sup>22</sup> In China, research on the extraordinary function of the human body has already attracted the interest of many scientists specialized in biology, physics, psychology, and the like. Special attention, dynamic support and specific direction have also been gained from certain famous scientists. Professor Qian Xue-sen published some special papers,<sup>5,29</sup> covering the relationship between the extraordinary function of the human body, qigong and Chinese traditional medicine, and emphasized the importance of developing the human being's potential capacity and exploring and developing a fundamental discipline of human body science. In his "Inaugurating Fundamental Research on Human Body Science" he pointed out that Chinese traditional medical theory, qigong and extraordinary function centered around the qigong state, are keys to research in the human body sciences, in which the basic principles of extraordinary human body function are included. Based on systems sciences, he also proposed the theory of functional states of the human body. These theoretical viewpoints have been playing an important directive role in launching fundamental research in the human body sciences.

We consider that, in the future study of the extraordinary functions of the human body in China, special attention should be paid to the

**UNCLASSIFIED**

**UNCLASSIFIED**

integration of the cream of Chinese traditional culture with the principles of modern science and technology, and the integration of qigong and Chinese traditional medical theory with the research on extraordinary function. This approach will bring the research work on the human body function into the orbit of modern science and technology.

### 3. Conclusion

Research on the extraordinary function of the human body are of great importance, both theoretically and practically. We firmly believe that there is nothing that cannot be understood in the world; there are only things that have not yet been understood. We are full of confidence as to the prospect of the study of the extraordinary function of the human body in China.

**UNCLASSIFIED**

**UNCLASSIFIED**

## REFERENCES

1. Chen Shouliang, He Muyan (Beijing University), "Findings Concerning One Type of Extraordinary Function of the Human Body: Part One," Nature Journal, Vol. 2, p. 715 (1979).
2. Xu Xinfang et al. (Anhui Teacher's Normal University), "Observations Concerning the Ear's Ability to Recognize Characters and Distinguish Colors," Nature Journal, Vol. 2, p. 716 (1979).
3. He Dahua et al. (Combined Investigation Group of Tazi County, Sichuan Province), "Observations Concerning Tang Yu's ability to Distinguish Colors and Recognize Characters with the Ear," Nature Journal, Vol. 2, p. 780 (1979).
4. Chen Shouliang et al., "The Decline and Restoration of Jiang Yan's Extraordinary Body Function," Nature Journal, Vol. 2, p. 781 (1979).
5. Qian Xuesen, "Basic Research for Developing the Sciences of the Human Body," Nature Journal, Vol. 4, p. 483 (1961).
6. He Chongyin (Nature Journal Publishing), "Extraordinary Function of the Human Body," China Encyclopedic Year-Book, 1981.
7. Combined Experimentation Group on Extraordinary Function of the Human Body, "Combined Experiment Report Concerning the Validity of Certain Extraordinary Functions of the Human Body," (1982), forthcoming.
8. Chen Shouliang et al., "The Question of the Prevalance of Extraordinary Human Body Functions," Nature Journal, Vol. 3, p. 334 (1980).
9. He Muyan et al., "Further Discussion on the Question of the Prevalence of Extraordinary Human Body Functions," Nature Journal, Vol. 3, p. 683 (1980).
10. Study Group of Yunnan University on Extraordinary Human Body Function, "Initial Experiments on the Mechanics Effect of Extraordinary Human Body Function," Nature Journal, Vol. 4, p. 348 (1981).

**UNCLASSIFIED**

**UNCLASSIFIED**

11. Lin Shuhuang, Zhang Zhongqi (Beijing Teacher's Normal College) et al., "Some Laboratory Tests on the Extraordinary Human Body Function of Moving Objects," Nature Journal, Vol. 4, p. 652 (1981).
12. Zhao Yongjie, Xu Hongzhang et al. (High-Energy-Physics Institute of the Chinese Academy of Sciences), "Laboratory Tests on the Study of the Physics of Human Body Radiation with Biological Detectors," Nature Journal, Vol. 4, p. 602 (1981).
13. Zhao, Yongjie et al., "Using the Quantum Number System to Capture the 'Fagong' radiation of Qigong and (other) Extraordinary Functions," Electronics Science and Technology, No. 7, p. 6 (1981).
14. Zheng Tianmin, Zhu Nianlin; Luo Xin (Yunnan University), Li Hongyi (Wuhan University) et al., "Unusual Phenomena of Extraordinary Human Body Function upon Photosensitive Detectors," Nature Journal, Vol. 4, p. 563 (1981).
15. Lin Shuhuang et al., "Magnetism and Extraordinary Function of the Human Body," Nature Journal, Vol. 4, p. 114 (1981).
16. Wang Shengli et al (Shanghai Institute for Laser Technology), "Laboratory Tests on the Non-Visual Recognition of the Color Spectrum," Nature Journal, Vol. 3, p. 336 (1980).
17. Fang Xiaoren, Liu Yicheng et al. (Physics Institute of the Chinese Academy of Sciences), "The Initial Determination of Extraordinary Human Body Function Subjects in regards to their Ability to Perceive Non-Visible Light," Nature Journal, Vol. 4, p. 895 (1981).
18. Zhang Zuqi et al. (Beijing University), "One Example of the Extraordinary Human Body Function of Direction Recognition," Nature Journal, Vol. 3, p. 741 (1980).
19. Zhang Zuqi et al. (Beijing University), "One Example of the Extraordinary Human Body Function of Direction Recognition: Part Two," Nature Journal, Vol. 4, p. 292 (1981).
20. Yang Jianhua (Biophysics Institute of the Chinese Academy of Sciences), "The Study of the Special Characteristics of the Body's Perception of Light at Specific Transmission Intensities," Nature Journal, Vol. 4, p. 897 (1981).
21. Liu Yicheng et al., "Initial Observations on the Ability to Perceive Special Optical Phenomena with Non-Visual Seeing," Nature Journal, Vol. 4, p. 900 (1981).

**UNCLASSIFIED**

**UNCLASSIFIED**

22. Zhang Yuzhi (Biophysics Institute) et al., "Response Sensitivity of the Human Body's Non-Visual Seeing to Four Different Wavelengths of Light," Nature Journal, Vol. 4, p. 104 (1982).
23. Wang Chu et al. (Beijing University), "The Process of Unscrambling Patterns," Nature Journal, Vol. 3, p. 438 (1980).
24. Chen Yi et al. (Changchun College for Traditional Chinese Medicine), "Results of Initial Laboratory Tests on the Ability of the Human Body to Enlarge Objects," Nature Journal, Vol. 4, p. 185 (1981).
25. Luo Ling-r et al (Beijing University), "The Process of Distinguishing Multi-layered Overlapping Objects with Extraordinary Human Body Function," Nature Journal, Vol. 4, p. 291 (1981).
26. Shao Shaoyuan et al. (Beijing University), "The Process of Unscrambling for Recognition by Extraordinary Human Body Function of Patterns on Folded and Rolled Paper," Nature Journal, Vol. 5, p. 274 (1982).
27. Ye Ziquan (Biophysics Institute of the Chinese Academy of Sciences), "The Human Body's Recognition of Non-Visible Patterns," Nature Journal, Vol. 5, p. 276 (1982).
28. Chen Taoqiu (No. 6 Factory for Radio Electronics, Liaoyuan City), "Verification and Exploration of Remote Mind-Reading," Nature Journal, Vol. 4, p. 756 (1981).
29. Qian Xuesen, "The Systematic Sciences, the Neuro Sciences and the Sciences of the Human Body," Nature Journal, Vol. 4, p. 3 (1981).

**UNCLASSIFIED**

**UNCLASSIFIED**

Appendix C

PARTIAL BIBLIOGRAPHY ON CHINESE WORK ON EHB (U)

**UNCLASSIFIED**

**UNCLASSIFIED**

THIS PAGE INTENTIONALLY LEFT BLANK

**UNCLASSIFIED**

**UNCLASSIFIED**

## Appendix C

## PARTIAL BIBLIOGRAPHY ON CHINESE WORK ON EHF (U)

## 1. ENGLISH (U)

- a. (U) 26 January 1981, FTD-ID(RS)T-1766 translation, Translation Div., Foreign Technology Div., WPAFB, Ohio 45433:
- (1) He Chongyin, "Investigations of the Profound Mysteries of Biotics-Opening Speech at the Human Body Special Functions Scientific Discussion Meeting."
  - (2) Chen Shouliang and He Muyan, "Investigative Report on Special Sensing Mechanisms in the Human Body (1)--The Question of the Authenticity of Special Sensing Mechanisms."
  - (3) Xu Xinfang, Xia Jiquan, Hua Zhaohe, Hu Zenggao, Zhang Lihong (Written by) Zhang Lihong, "Investigative Report on the Mechanism of the Recognition of Characters and the Discrimination of Colors with the Ear."
  - (4) Xie Yuyu and Wang Zhixiu, "Brief Summary of Observations on Xie Chaohui's Use of the Ear to Recognize Characters and Discriminate Pictures and Colors."
  - (5) He Dahua, Ding Xianfa, Shen Zhenglun, Zhu Yongdi and Hu Zhengshu, "Investigative Report on Tang Yu's Discrimination of Colors and Recognition of Characters with the Ear."
  - (6) Chen Shouliang, He Muyan, Wang Chu and Zhu Shui, "Decline and Recovery of Jiang Yan's Special Sensory Mechanism."
  - (7) Reporter, Nature Journal (Ziran Zazhi), "Observation Report on the 'Non-Visual Recognition of Images'."
  - (8) Luo Dongsu, "Discussion of Non-Visual Recognition of Images and the Electromagnetic Sensor Mechanism in the Human Body."
- b. (U) 'Psi Research' (Journal), L. Vilenskaya, Ed., 3101 Washington St., San Francisco, California 94115:
- (1) Zhao Yun-Je, Xu Hongzhang, Shen Jing, Liu Aihua, "Biodetector Experiments on Human Body Radiation Physics," Vol. 1, No. 1, pp. 77-83 (March 1982).

**UNCLASSIFIED**



**UNCLASSIFIED**

- (2) Qian Xue Sen, "Some Theoretical Ideas on the Development of Basic Research in Human Body Science," Vol. 1, No. 2, pp. 4-15 (June 1982).
- (3) Special Physics Research Team, Institute of High-Energy Physics, Beijing, "Exceptional Human Body Radiation," Vol. 1, No. 2, pp. 16-25 (June 1982).

2. CHINESE (U)

a. (U) 'Nature' Journal (Ziran Zazhi):

- (1) Ku Han-sen, "Basic Research on the Material of the Qiqong Vital Force--The Results of Preliminary Experiments on Microparticle Flow," Vol. 2, No. 5, p. 271 (May 1979) and Vol. 2, No. 6, p. 370 (June 1979).
- (2) Chen Shouliang, He Muyan (Peking University), "Findings Concerning One Type of Extraordinary Function of the Human Body: Part One," Vol. 2, p. 715 (1979).
- (3) Xu Xinfang et al. (Anhui Teacher's Normal University), "Observations Concerning the Ear's Ability to Recognize Characters and Distinguish Colors," Vol. 2, p. 716 (1979).
- (4) He Dahua et al. (Combined Investigation Group of Tazi County, Sichuan Province), "Observations Concerning Tang Yu's Ability to Distinguish Colors and Recognize Characters with the Ear," Vol. 2, p. 780 (1979).
- (5) Chen Shouliang et al., "The Decline and Restoration of Jian Yan's Extraordinary Body Function," Vol. 2, p. 781 (1979).
- (6) Chen Shouliang et al., "The Question of the Extraordinary Human Body Functions," Vol. 3, p. 334 (1980).
- (7) Wang Shengli et al. (Shanghai Institute for Laser Technology), "Laboratory Tests on the Non-Visual Recognition of the Color Spectrum," Vol. 3, No. 5, p. 336 (May, 1980).
- (8) Wang Chu et al. (Peking University), "The Process of Unscrambling Patterns," Vol. 3, p. 438 (1980).
- (9) Ku Han-sen, "A Preliminary Study on the Transmission and Reception of Vitalist-Code by the Human Body," Vol. 3, No. 8, p. 563 (August 1980).
- (10) Ho Qing Nian, "A General View of Information Therapy," Vol. 3, No. 8, p. 566 (August 1980).

**UNCLASSIFIED**

**UNCLASSIFIED**

- (11) Zhang Feng, "New Advanced in the Study of the Extraordinary Function of Human Body," Vol. 3, No. 8, p. 606 (August 1980).
- (12) He Muyan et al., "Further Discussion on the Question of the Prevalance of Extraordinary Human Body Function," Vol. 3, p. 683 (1980).
- (13) Zhang Zuqi et al. (Peking University), "One Example of the Extraordinary Human Body Function of Direction Recognition," Vol. 3, p. 741 (1980).
- (14) Qian Xue-sen, "System Science, Neuroscience and Human Body Science," Vol. 4, No. 1, p. 3 (January 1981).
- (15) Lin Shu-huang et al., "Magnetism and Extraordinary Functions of the Human Body," Vol. 4, No. 2, p. 114 (February 1981).
- (16) Chen Yi et al. (Changchun College for Traditional Chinese Medicine), "Results of Initial Laboratory Tests on the Ability of the Human Body to Enlarge Objects," Vol. 4, p. 185 (1981).
- (17) Wang Jia-lin, "The Significance of the Internal Action of Psycho-Body-Energy (Qigong) to the Vital Activity of the Human Body," Vol. 4, No. 3, p. 165 (March 1981),
- (18) Luo Ling-R et al. (Peking University), "The Process of Distinguishing Multi-layered Overlapping Objects with Extraordinary Human Body Function," Vol. 4, p. 291 (1981).
- (19) Zhang Zuqi et al. (Peking University), "One Example of the Extraordinary Human Body Function of Direction Recognition: Part Two," Vol. 4, p. 292 (1981).
- (20) Study Group of Yunnan University on Extraordinary Human Body Function, "Initial Experiments on the Mechanics Effect of Extraordinary Human Body Functions," Vol. 4, p. 348 (1981).
- (21) Lin Guan-jun et al., "Special Function and the Phenomenon of the Human Body Channel," Vol. 4, No. 6, p. 423 (June 1981).
- (22) Qian Xue-sen, "Launching Fundamental Research on Human Body Science," Vol. 4, No. 7 p. 483 (July 1981).
- (23) Nie Chun-rong, "Promoting the Exploration of Human Body Paranormal Function," Vol. 4, No. 7, p. 489 (July 1981).
- (24) He Chongyin, "Yearly Advanced and Future Prospects of the Study of Human Body Extraordinary Functions," Vol. 4, No. 7, p. 492 (July 1981).
- (25) Zheng Tian-min et al., "The Unusual Phenomena of Human Body Paranormal Function in Some Phototransistor Detectors," Vol. 4, No. 8, p. 563 (August 1981).

**UNCLASSIFIED**

**UNCLASSIFIED**

- (26) Zhao Yun-Je, Xu Hongzhang, Shen Jing and Liu Aihua, "Biodetector Experiments on Human Body Radiation Physics," Vol. 4, No. 8, p. 602 (August 1981).
- (27) Song Guimei et al., "The Sign of Circulating 'Qi'," Vol. 4, No. 8, p. 638 (August 1981).
- (28) Lin Shuhuang, Zhang Zhongqi (Peking Teacher's Normal College), et al., "Some Laboratory Tests on the Extraordinary Human Body Function of the Movement of Objects," Vol. 4, No. 9, p. 652 (September 1981).
- (29) Mei Lei et al., "Brain Wave Analysis in Qigong State," Vol. 4, No. 9, p. 662 (September 1981).
- (30) Xu Shunqing and Yu Zhijiang, "Bioenergy and its Utilization," Vol. 4, No. 9 (September 1981).
- (31) Chen Taoqiu (No. 6 Factory for Radio Electronics, Liaoyuan City), "Verification and Exploration of Remote Mind-Reading," Vol. 4, p. 756 (1981).
- (32) Fang Xiaoren, Liu Yicheng et al. (Physics Institute of the Chinese Academy of Sciences), "The Initial Determination of Extraordinary Human Body Function Subjects in Regards to Their Ability to Perceive Non-Visible Light," Vol. 4, p. 895 (1981).
- (33) Yang Jianhua (Biophysics Institute of the Chinese Academy of Sciences), "The Study of the Special Characteristics of the Body's Perception of Light at Specific Transmission Intensities," Vol. 4, p. 897 (1981).
- (34) Liu Yicheng et al., "Initial Observations on the Ability to Perceive Special Optical Phenomena with Non-Visual Seeing," Vol. 4, p. 900 (1981).
- (35) Zhang Yuzhi (Biophysics Institute) et al., "Response Sensitivity of the Human Body's Non-Visual Seeing to Four Different Wavelengths of Light," Vol. 5, p. 104 (1982).
- (36) Shao Shaoyuan et al. (Peking University), "The Process of Unscrambling for Recognition by Extraordinary Human Body Function of Patterns on Folded and Rolled Paper," Vol. 5, p. 274 (1982).
- (37) Ye Ziquan (Biophysics Institute of the Chinese Academy of Sciences), "The Human Body's Recognition of Non-Visible Patterns," Vol. 5, p. 276 (1982).

**UNCLASSIFIED**

UNCLASSIFIED

b. (U) Miscellaneous:

- (1) Zhao, Yongjie et al., "Using the Quantum Number System to Capture the 'Fagong' radiation of Qigong and (other) Extraordinary Functions," Electronics Science and Technology, No. 7, Vol. 6 (1981).
- (2) He Chongyin (Nature Magazine Publishing)., "Extraordinary Function of the Human Body," 1981 China Encyclopedic Alamanac.
- (3) Combined Experimentation Group on Extraordinary Function of the Human Body, "Combined Experiment Report Concerning the Validity of Certain Extraordinary Functions of the Human Body," (1982) Forthcoming.

UNCLASSIFIED

**UNCLASSIFIED**

THIS PAGE INTENTIONALLY LEFT BLANK

**UNCLASSIFIED**

SG1B

Approved For Release 2000/08/11 : CIA-RDP96-00792R000400320001-8

Approved For Release 2000/08/11 : CIA-RDP96-00792R000400320001-8

**UNCLASSIFIED**

THIS PAGE INTENTIONALLY LEFT BLANK

**UNCLASSIFIED**

SG1B

Approved For Release 2000/08/11 : CIA-RDP96-00792R000400320001-8

Next 3 Page(s) In Document Exempt

Approved For Release 2000/08/11 : CIA-RDP96-00792R000400320001-8



**SECRET**

**SPECIAL ACCESS PROGRAM FOR GRILL FLAME.  
RESTRICT DISSEMINATION TO ONLY INDIVIDUALS WITH VERIFIED ACCESS.**

**WARNING NOTICE**  
Intelligence Sources  
and Methods Involved

**NOT RELEASABLE TO  
FOREIGN NATIONALS**

**SECRET**