

~~Top Secret~~

**Interagency  
Intelligence  
Report**

**CIA HISTORICAL REVIEW PROGRAM  
RELEASE AS SANITIZED**

*A Soviet Land-Mobile ICBM: Evidence of  
Development and Considerations Affecting  
a Decision on Deployment*

~~Top Secret~~

~~TCS 009100-74~~

October 1974

Copy N<sup>o</sup> 229

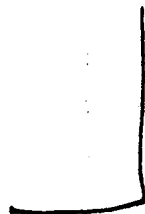
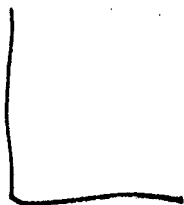
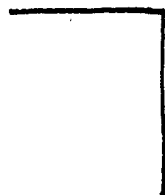
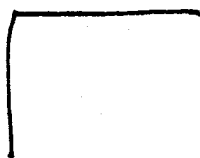

~~Top Secret~~

A SOVIET LAND-MOBILE ICBM:  
EVIDENCE OF DEVELOPMENT  
AND CONSIDERATIONS AFFECTING  
A DECISION ON DEPLOYMENT

~~TGS 880100 74~~

~~Top Secret~~

## CONTENTS

	Page
PREFACE .....	1
SUMMARY .....	2
INTRODUCTION .....	4
CANDIDATES FOR LAND-MOBILE ICBM DEVELOPMENT .....	5
SS-X-16 FLIGHT TEST PROGRAM .....	5
EVIDENCE OF A MOBILE VERSION OF THE SS-X-16 .....	6
Planned Production .....	7
Development of Equipment for a Mobile ICBM .....	8
Activity at Plesetsk .....	10
Heavy Investment in the SS-X-16 Program .....	16
SALT STATEMENTS .....	17
POSSIBLE DEPLOYMENT MODES .....	18
Road-Mobile and Off-Road Mobile Concepts .....	19
Shelter-Based and Rail-Mobile Concepts .....	19
FACTORS AFFECTING THE SOVIET DECISION TO DEPLOY A LAND-MOBILE ICBM .....	19
Incentives for Deployment .....	22
Considerations Militating Against Deployment .....	22
POSSIBLE SIZE OF THE FORCE .....	24

	Page
ANNEX A: [ ] .....	25
ANNEX B: [ ] .....	27
ANNEX C: GEOGRAPHIC FACTORS AFFECTING DEPLOYMENT OF LAND-MOBILE ICBM SYSTEMS .....	29

FIGURES

	Page
1. Map of USSR: Test Centers, Assembly Facility and SS-13 Launch Complex .....	5
2. SS-X-16 Flight Test Program .....	6
3. Plesetsk: Map of Launch Sites Related to SS-X-16 Program .....	7
[ ]	]
5. Plesetsk: Unusual SS-X-16 Railcars .....	11
6. Artist's Concept of Mobile ICBM Unit .....	12
[ ]	]
13. USSR: Population Density and Transportation .....	<i>follows 30</i>
14. USSR: Areas Suitable for Off-Road Deployment of Land-Mobile ICBMs .....	<i>follows 30</i>

# A SOVIET LAND-MOBILE ICBM: EVIDENCE OF DEVELOPMENT AND CONSIDERATIONS AFFECTING A DECISION ON DEPLOYMENT

## PREFACE

This Interagency Intelligence Report was prepared by the Central Intelligence Agency with the collaboration of the Defense Intelligence Agency, the National Security Agency, and the intelligence organizations of the Departments of State, Air Force, Navy, and Army.

The report was prepared at the request of the National Intelligence Officer for Strategic Programs. The analytical and drafting responsibilities were carried out by an interagency working group under the chairmanship of CIA.

The study presents and analyzes the evidence that points to the development of a Soviet land-mobile ICBM, and examines the considerations that seem likely to affect a decision on deployment of such a system. The report is based on information available as of October 1, 1974.

## SUMMARY

We believe that the Soviets are developing a new land-mobile ICBM and that the best candidate is the solid-propellant SS-X-16. This judgment is based on the following major areas of evidence:

- Planned production of large numbers of SS-X-16 ICBMs.
- Development of equipment for the SS-X-16 similar to that used by previous land-mobile systems.
- Association of launch sites at Plesetsk, previously used with mobile systems, with the SS-X-16 program and a ground support equipment (GSE) test program at Plesetsk that employs extensive concealment.
- Expenditure of considerable resources to fund a new missile development program—a seemingly illogical commitment if the missile were just to replace the 60 missiles in the SS-13 force.

Development of the mobile version of the SS-X-16 has been marked by an unprecedented concealment effort at the Plesetsk missile and space center. [

] Test-  
ing of the SS-X-16 to ICBM range from a mobile launch platform may not yet have occurred, although testing of associated ground support equipment appears to be under way. If testing of a mobile version begins in the near future, the Soviets probably would have their first mobile SS-X-16 units ready for deployment by 1977.

The Soviets may have decided to develop a version of the SS-X-16 as a mobile ICBM to have ready for deployment by 1977, when the Interim Agreement expires. Whether the Soviets deploy a mobile ICBM probably hinges on the negotiations at SALT and on the success of the missile program.

Assuming the Soviets do decide to deploy a mobile version of the SS-X-16, they could easily deploy about 30 launchers in 1977 and have 120 in the field by 1980. In a more threatening strategic environment, they might begin deployment a year earlier, in 1976, with about 25 launchers and could build up the force to some 275 launchers by about 1980.

A land-mobile ICBM could be deployed in any of several possible modes, but the activity at the test range suggests the Soviets are considering both road- and off-road-mobile concepts for the SS-X-16. Mobile units could be rotated among various presurveyed fixed-field sites or unprepared positions, perhaps as far as 50 miles from a support base. Existing Strategic Rocket Force or possibly Ground Force installations could be used as support bases.

The Soviets probably see development of a mobile ICBM as a hedge against a possible lapse of the Interim Agreement, as a potential bargaining chip for future agreements, and as a prudent move to offset the effect of the increased accuracy of US missiles. Deployment of a mobile ICBM would increase the survivability of the Soviet ICBM force.



## INTRODUCTION

1. The Soviets have been interested in land-mobile strategic ballistic missiles since the 1950s, but they have yet to deploy such a system. Of the four land-mobile missiles tested, only the SS-1 tactical short-range liquid-propellant missile received wide deployment. The SS-12 SRBM was deployed in smaller numbers, and programs for two longer-range missiles, the SS-14 MRBM and the SS-X-15, ended in early 1970 prior to deployment.

2. During the mid-1960s, when the SS-13, SS-14, and SS-X-15 were under development, the Soviets made numerous references in their military press to land-mobile missiles, frequently hinting that mobile medium- and intercontinental-range ballistic missiles were already deployed with the Strategic Rocket Forces (SRF). The press articles consistently emphasized that Soviet land-mobile missiles would be:

- fueled by solid propellants, which would give them quick reaction time;
- comparatively small; and
- practically invulnerable, because they would be highly maneuverable, would

change position frequently, and could be easily camouflaged.

3. In 1966 and again in 1968, Marshal N. I. Krylov, then commander in chief of the SRF, said that the attention of Soviet science was being concentrated on the development of mobile missiles. In his 1968 statement, Krylov also said that the Soviets had solved this problem. In general, statements made by SRF officers tended to suggest that mobile missiles were being *deployed*, while statements made by non-SRF officers tended to emphasize the *development* of mobile missiles.

4. In other articles, the Soviets wrote about a three-stage, solid-propellant ICBM (presumably the SS-13) that could be fired both from silos and from mobile launch platforms. Such statements declined in frequency after 1968, although as recently as 1971 General S. S. Maryakhin, then chief of Rear Services for the Soviet Armed Forces, claimed that the SRF was becoming increasingly mobile and invulnerable.

5. Our judgment is that the Soviets now have a new land-mobile ICBM under development.

### CANDIDATES FOR LAND-MOBILE ICBM DEVELOPMENT

6. There is, at present, one good candidate for a land-mobile ICBM—the SS-X-16. This missile is a three-stage ICBM, one version of which almost certainly is intended to replace the SS-13 ICBM force, which is deployed in 60 silos at the Yoshkar-Ola ICBM complex (see Figure 1 for map of place names). The SS-X-16 is undergoing flight testing at the Plesetsk missile and space center. It uses solid propellants and has a post-boost vehicle suitable for dispensing MIRVs. To date the SS-X-16 has been tested only with a single RV.

7. The Soviets also have under development another solid-propellant missile [ ]

[ ] suggests that it is an IRBM and not an ICBM. Its intended deployment mode and maximum range are unknown.

### SS-X-16 FLIGHT TEST PROGRAM

8. Since the first launch from Plesetsk in March 1972, the SS-X-16 has been test flown 20 times, 15 times successfully (see Figure 2). The last ten launches were conducted at night, suggesting that the Soviets wanted to prevent the US from observing launch activity. After only four test flights in 1972 there was an

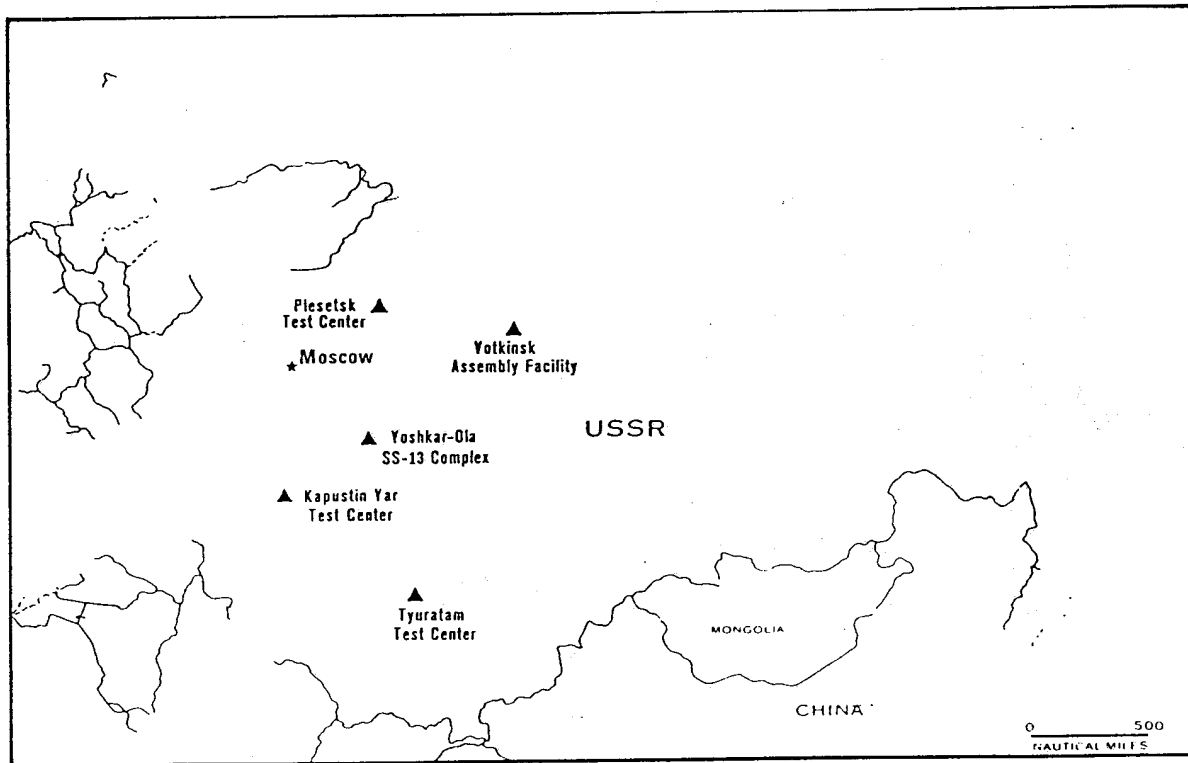

Figure 1. Test Centers, Assembly Facility and SS-13 Launch Complex

564795 10-74 CIA  
TCS 880100 74

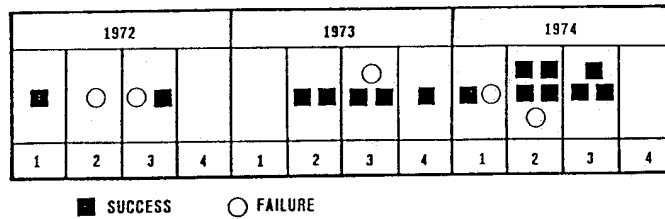

Figure 2. SS-X-16 Flight Test Program

564296 10-74 CIA  
TCS 888464/74

eight month hiatus in the program. ] indicates the Soviets modified the missile during this period. Moreover ]

] revealed significant quality control problems.

9. The missile was flight tested only six times in 1973. The pace of the SS-X-16 test program has accelerated in 1974, with 10 launches as of October 1. ]

] we cannot rule out the possibility that some of the SS-X-16 tests were for the mobile mode option.

] A silo-based version of the SS-X-16 with a single RV could be ready for deployment in 1975.

11. We would expect a full series of tests—perhaps for one to two years—to check out the mobile option before the system could be deployed. ]

10. We have no firm evidence that the SS-X-16 has been launched from a mobile platform. We believe that the majority of SS-X-16 launches have come from SS-13 silos. ]

] EVIDENCE OF A MOBILE VERSION OF THE SS-X-16

12. Evidence to support the existence of a mobile option in the SS-X-16 program falls into four major areas:

\*The first seven tests of the SS-13 were short-range firings from Kapustin Yar.

- Planned production of large numbers of SS-X-16 ICBMs.

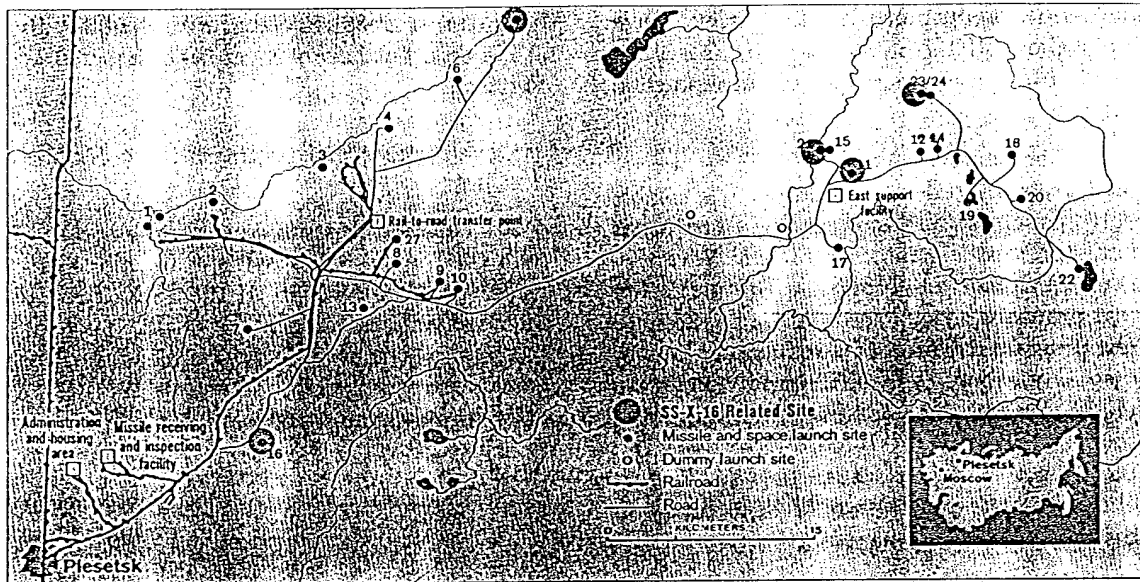

Figure 3. Plesetsk: Launch Sites Related to SS-X-16 Program

564287 10-74 CIA  
665 00001716

- Development of equipment for the SS-X-16 similar to that used by previous mobile systems.
- Association of launch sites at Plesetsk, previously used with mobile systems, with the SS-X-16 program and a ground support equipment (GSE) test program at Plesetsk that employs extensive concealment.
- Expenditure of considerable resources to fund a new missile development program—a seemingly illogical commitment if the missile were just to replace the SS-13 force.

[ ]

we believe that the bulk of evidence indicates that production beyond that needed to replace the SS-13 was destined for a mobile version of the system.

Planned Production

13. [ ]

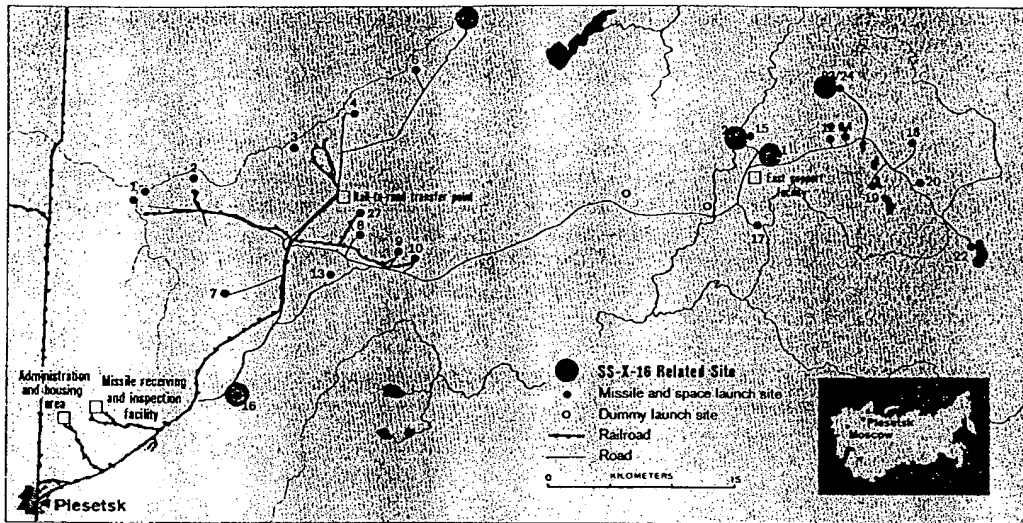

Figure 3. Plesetsk: Launch Sites Related to SS-X-16 Program

564297 10-74 CIA

TOP SECRET RUFF

- Development of equipment for the SS-X-16 similar to that used by previous mobile systems.
- Association of launch sites at Plesetsk, previously used with mobile systems, with the SS-X-16 program and a ground support equipment (GSE) test program at Plesetsk that employs extensive concealment.
- Expenditure of considerable resources to fund a new missile development program—a seemingly illogical commitment if the missile were just to replace the SS-13 force.

[ we believe that the bulk of evidence indicates that production beyond that needed to replace the SS-13 was destined for a mobile version of the system. ]

Planned Production

13. ]

[ ]

Development of Equipment for a Mobile ICBM

20. The same types of equipment associated with the mobile SS-14 MRBM are also associated with the SS-X-16. If the SS-X-16 were intended only to replace the SS-13, much of this equipment would not be needed. The Soviets have designed a fiberglass canister, a dolly to move the canister, and a rail flatcar to transport it.

21. A launch canister probably would be needed to fire the SS-X-16 from a mobile platform. The SS-X-16 canister is similar in size to the canister for the SS-X-15 seen during its test program.

18. The SS-X-16 is assembled at a plant near Votkinsk

in 1971, the Soviets constructed an additional missile assembly building in the SS-X-16 portion of the plant. The increased SS-X-16 assembly capacity indicates that space for a force larger than that needed to replace the SS-13 was planned and is available if they choose to go ahead with mobile deployment.

19. the Soviets have erected permanent shelters over some 835 feet of railroad track at the Votkinsk missile assembly facility (see Figure 4).

The container

probably will be used for both transporting and launching the missile. Since the SS-X-16 probably does not require a launch canister when installed in the SS-13 silo, we believe that the canister was designed to permit launching from a mobile platform.

22. A key component of a mobile system is the dolly, which is needed to move the missile from the road transporter to the transporter-erector-launcher (TEL). A dolly for the SS-X-16 was available in limited numbers in August 1972 and was still being modified as late as December 1972. Shortly thereafter, in early 1973, SS-X-16 GSE testing at Plesetsk was intensified.

~~Top Secret~~

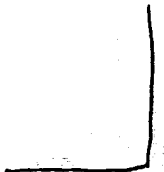
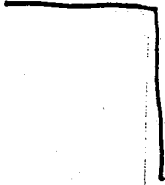
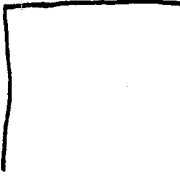

~~TOP SECRET~~

9  
~~Top Secret~~

23 [

mobile missile system [

] An artist's concept of a deployed mobile ICBM unit appears in Figure 6.

] Unusual railcars (see Figure 5) and a flatcar carrying a canister have been seen at the SS-X-16 assembly and checkout area at Plesetsk. Flatcars were used as one method of transporting the SS-14. The railcars for the SS-X-16 might be used to transport the mobile version of the missile and its ground support equipment.

24. The key element of a mobile-launch unit that has not yet been positively identified at Plesetsk is the TEL for the SS-X-16. [

] The TEL would be the most important piece of GSE being tested there.

#### Activity at Plesetsk

25. Activity at Plesetsk strongly suggests that a covert program is under way to develop a land-mobile ICBM. The observed activity suggests that the Soviets are checking out ground support equipment associated with a mobile version of the SS-X-16.

26. [

] 29. The initial phase of checking out ground support equipment for a mobile system at Plesetsk probably occurred during late 1972. [

] 30. The next phase of the program apparently started in the spring of 1973 and probably involved the testing and evaluation of launcher-related equipment—TELS and re-supply vehicles—on secondary roads. [

] None of this activity would be required for the development of a silo-based version of the SS-X-16. It would, however, be consistent with a program to conceal ground support equipment for a [



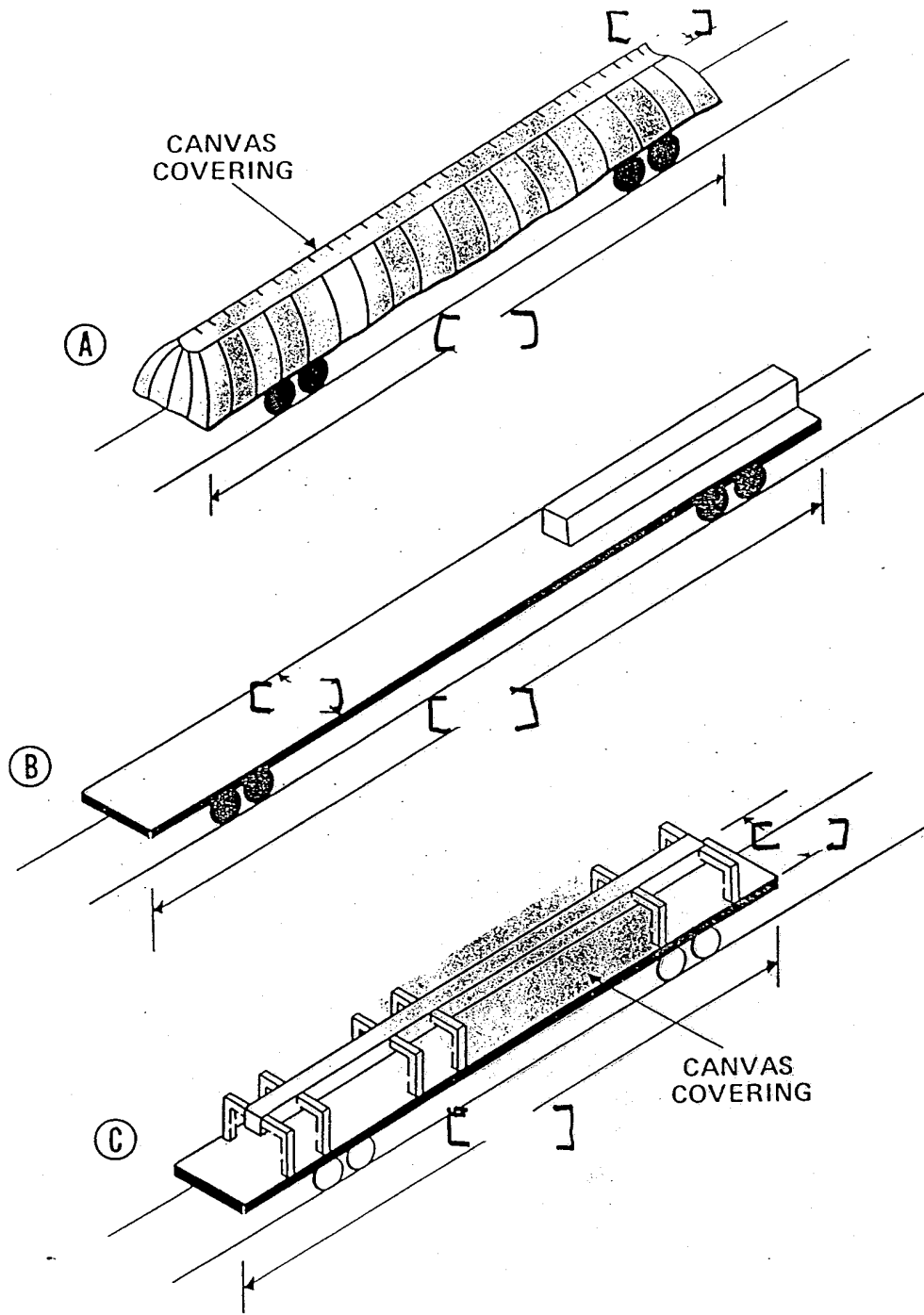

This is an artist's concept of some of the unusual SS-X-16 railcars seen at the Plesetsk Missile Handling Facility. These railcars were specially developed for the SS-X-16

Figure 5. Plesetsk: Unusual SS-X-16 Railcars

564299 10-74 CIA

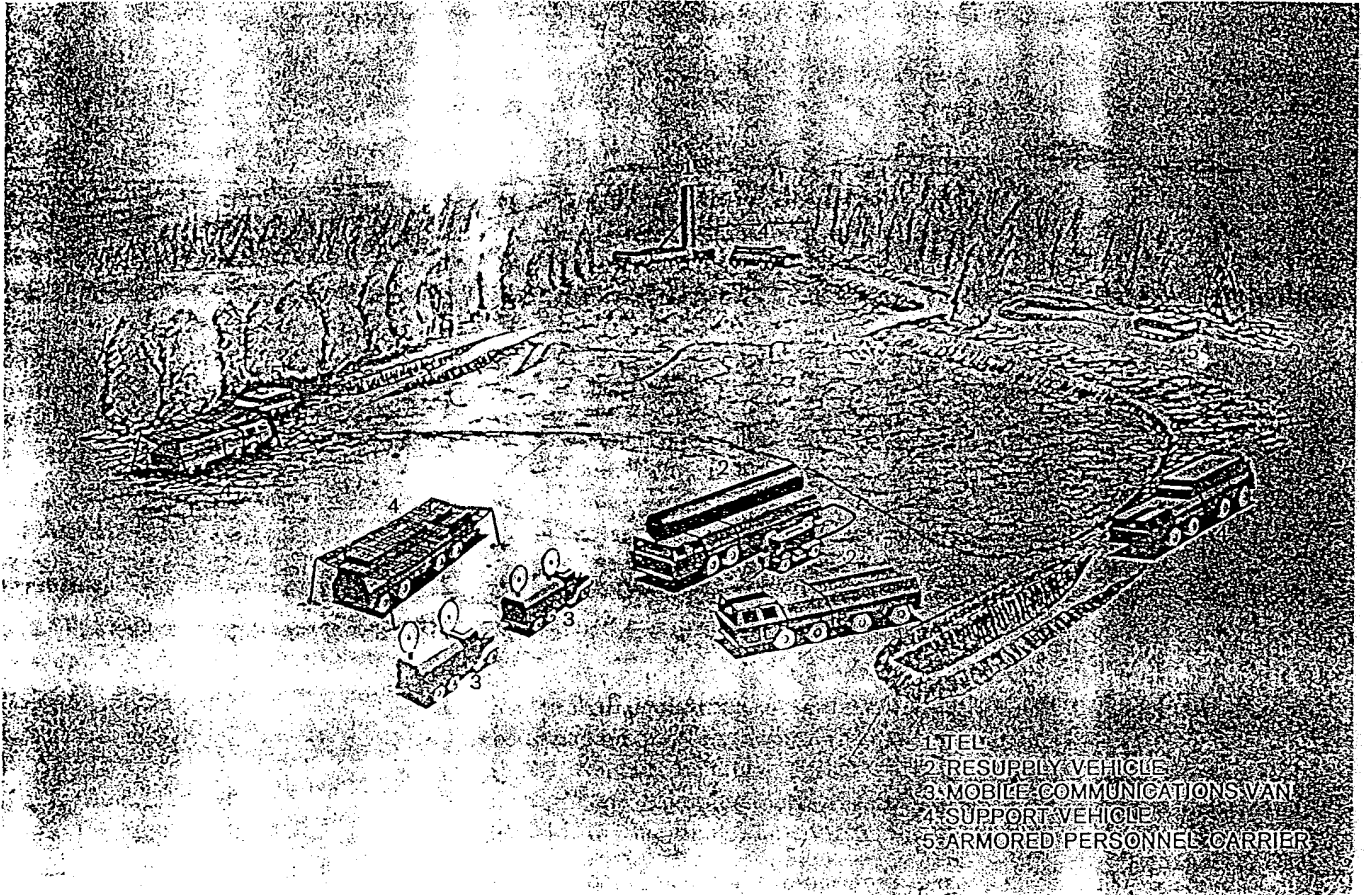

- 1 TEL
- 2 RESUPPLY VEHICLE
- 3 MOBILE COMMUNICATIONS VAN
- 4 SUPPORT VEHICLE
- 5 ARMORED PERSONNEL CARRIER

This is an artist's concept of how a mobile ICBM unit might be deployed in the field. Such a unit probably would include: a TEL, resupply vehicles, mobile communications vans, support vehicles and armored personnel carriers.

Figure 6. Artist's Concept of Mobile ICBM Unit

564301 10-74 CIA  
REF ID: A66866

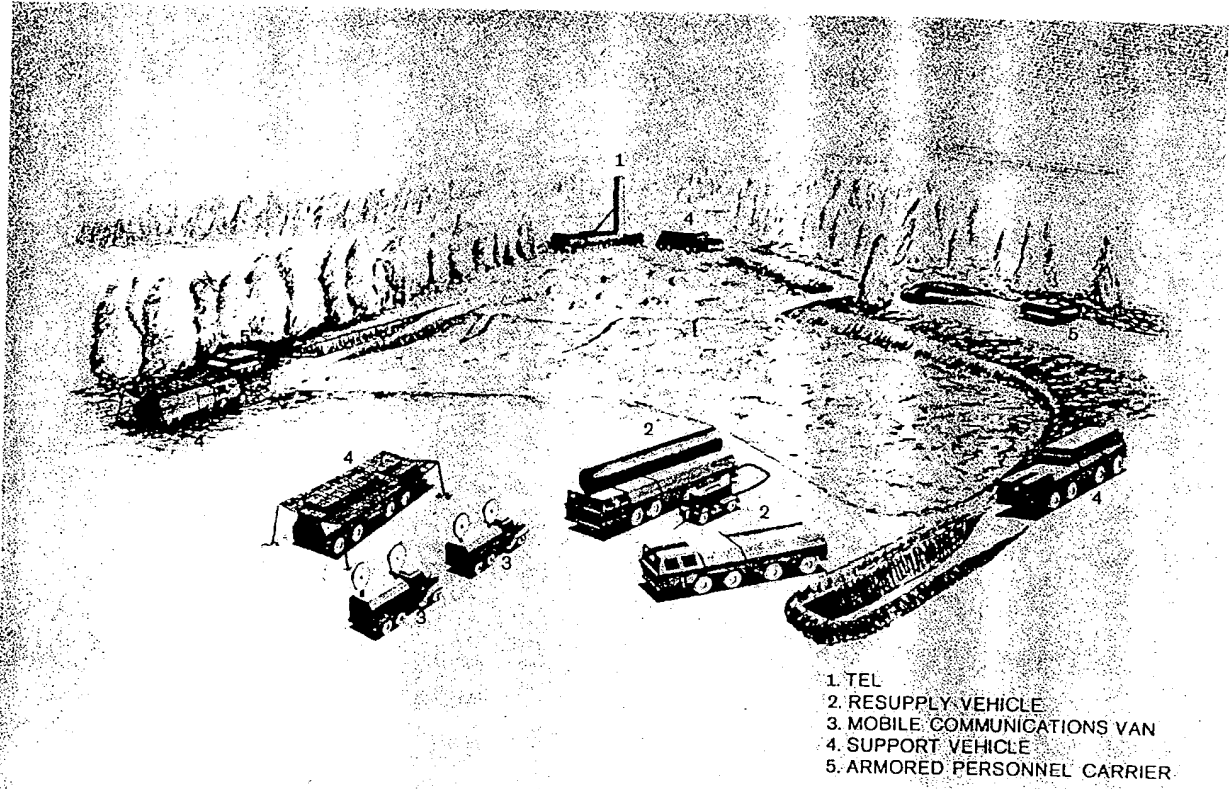

This is an artist's concept of how a mobile ICBM unit might be deployed in the field. Such a unit probably would include: a TEL, resupply vehicles, mobile communications vans, support vehicles and armored personnel carriers.

Figure 6. Artist's Concept of Mobile ICBM Unit

564301 10-74 C2A

~~Top Secret~~

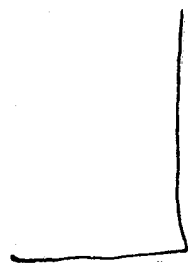
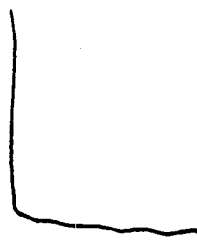
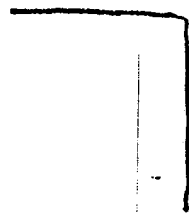
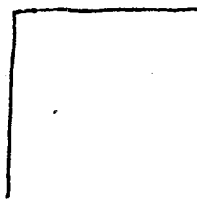

~~TCS 880100-74~~

~~Top Secret~~

~~Top Secret~~

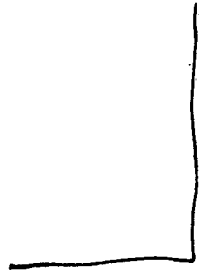
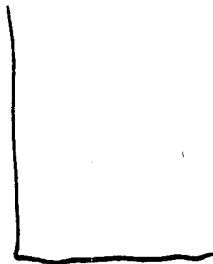
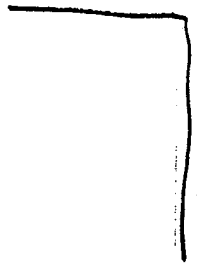
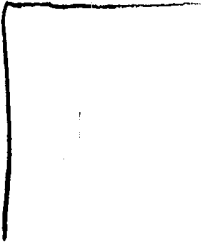

~~TCS 009100-74~~

14  
~~Top Secret~~

~~Top Secret~~

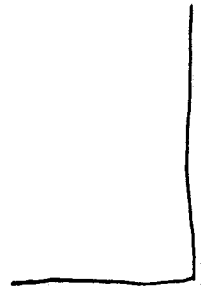
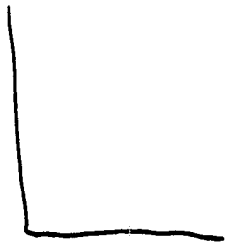
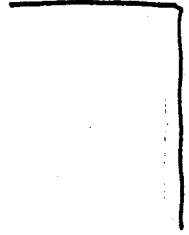
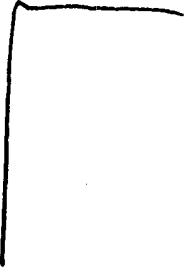

31. The current phase of the GSE program began in mid-1974 and probably involves testing the support equipment as an operating unit.

Heavy Investment in the SS-X-16 Program

33. The Soviets have invested heavily in the SS-X-16 program, a commitment that seems excessive merely to fill the 60 SS-13 silos at the Yoshkar-Ola complex. If they wanted only

to replace the SS-13s with an improved missile, it would seem less expensive to install one of the other new ICBMs currently under development, rather than to fund a separate R&D program.

### SALT STATEMENTS

34. Throughout the SAL negotiations, the Soviets consistently have opposed US attempts to ban deployment of land-mobile strategic systems. In 1970 Vladimir Semenov, head of the Soviet SALT delegation, stated:

Land-based ICBM launchers include both fixed and mobile launchers . . . and must be included in the overall aggregate level of strategic offensive armaments on an equal basis with fixed launchers. Establishment of any kind of additional limitations or prohibitions . . . is superfluous. . . . These launchers are but a variety of mobile systems which include submarines and nuclear-capable aircraft. Verification of land-mobile ICBM launchers . . . would obviously not be any more difficult than, say, verification of submarines and their ballistic missile launchers.

Therefore, justification of a ban on land-mobile ICBM launchers on the grounds of difficulties of verification by national means appears artificial to the Soviet side.

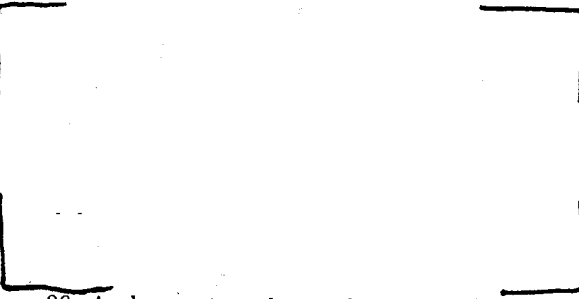

36. A change in policy indeed seemed possible at the Moscow Summit. During preliminary discussions at the final negotiations that ended with the signing of the Interim Agreement in May 1972, CPSU General Secretary Brezhnev reversed the position taken by the Soviet SALT delegation and agreed to ban mobile ICBMs. Shortly thereafter, however, the Soviets retracted Brezhnev's preliminary agreement on this issue. Whether Brezhnev was ill-informed about the Soviet position and simply had made an error, or whether the Soviet military refused to negotiate away a promising program cannot be determined.

37. Failing to limit land-mobile missiles in the negotiations, the US unilaterally stated that it

. . . would consider the deployment of operational land-mobile ICBM launchers during the period of the Interim Agreement as inconsistent with the objectives of that Agreement.

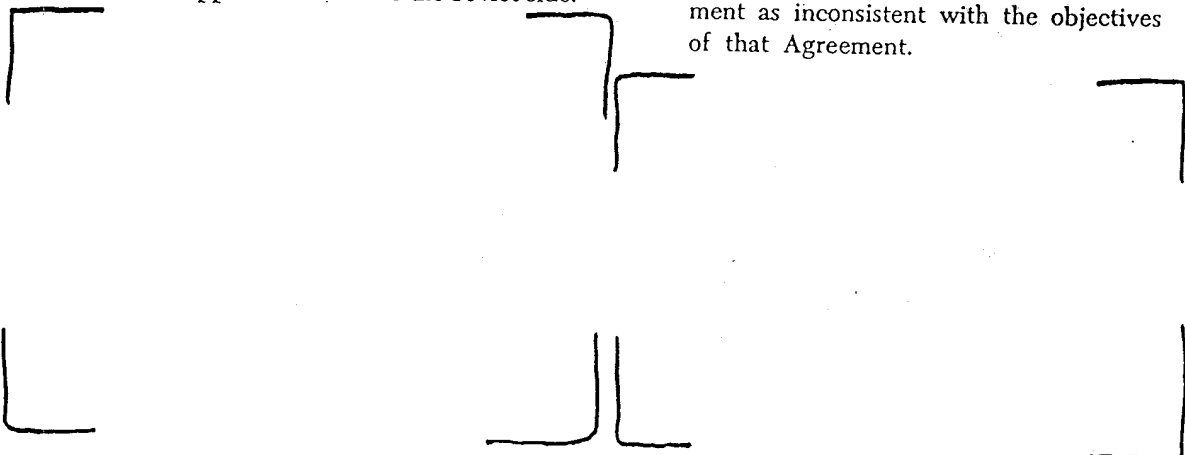





39. In June 1974, after months of discussion, a preliminary agreement was signed stating that

. . . facilities remaining at (deactivated) ICBM launch sites shall not be used for storage, support, or launch of ICBMs but may, at the discretion of the parties, be used for purposes not inconsistent with the provisions of the Interim Agreement and the Protocol thereto.



40. Whatever the relationship between Soviet public statements and reality, the record shows that Soviet military leaders have long been aware of the contribution that an effective land-mobile missile force could make to the survivability of their strategic deterrent. The exaggerated quality of their statements during the 1960s suggests that the Soviets also may have expected to reap political benefits from possession of even a marginally effective mobile missile force. They frequently emphasized that only they had such a weapon,

that development of a mobile missile was a technological "first" for the Soviet Union.

41. In this connection, the Soviets implied in public statements made during the 1960s that the SS-13 was intended for a mobile role. Although there is no supporting evidence, the statements suggest that a requirement existed—and may still exist—for both a mobile ICBM and a mobile MR/IRBM.

42. At SALT, Soviet unwillingness to negotiate a ban strongly suggests that they are keeping open an option to develop and deploy mobile ICBMs. This may have been a precondition to military—especially SRF—support for an arms agreement.

43. [ ] the Soviets have taken a position that would not preclude the use of deactivated ICBM sites as support bases for mobile MR/IRBMs. Furthermore, the preliminary agreement does not cover deactivated Soviet SS-4 and SS-5 MR/IRBM sites. These sites, which have as many support facilities as SS-7 or SS-8 ICBM sites and which, in any case, have presurveyed, fixed field sites, could be used to support a mobile ICBM. Some MR/IRBM complexes are being used to support the mobile SS-12 Scaleboard, a tactical ballistic missile, which is deployed at isolated field sites.

#### POSSIBLE DEPLOYMENT MODES

44. A land-mobile ICBM could be deployed in various modes including road-mobile, off-road mobile, shelter-based, and rail-mobile. There is evidence that suggests the Soviets are considering both the road-mobile and off-road mobile concepts but no clear evidence to suggest that shelter-based or rail-mobile systems are under development.

45. We believe that the Soviets would elect to use existing SRF installations as support

~~Top Secret~~

bases for a mobile version of the SS-X-16. For example, deactivated SS-4 and SS-5 sites, ICBM complex support facilities, and SRF regional storage facilities, all of which are rail-served, could be used. There are numerous areas around SRF installations which are suitable for mobile ICBM deployment (see Annex C). Support bases used by tactical mobile missiles also might be employed.

#### Road-Mobile and Off-Road Mobile Concepts

46. The evidence at Plesetsk indicates that the Soviets are investigating both of these operational concepts for a mobile ICBM. One deployment mode probably under consideration is the use of presurveyed, fixed-launch sites and a main support base. Any SRF installation with adequate support facilities could serve as a support base for a mobile system. The use of site 5—a former SS-7 soft site—at Plesetsk as a support area suggests this possibility. Missile units could be rotated among various presurveyed fixed field sites, perhaps as far as 50 miles from the support base. The revetments near site 16 at Plesetsk suggest that the Soviets are considering the use of fixed-field sites for the mobile version of the SS-X-16 (see Figure 11).

47. Another deployment possibility is the use of any unprepared, presurveyed area, such as a road intersection, for a launch point. There are many unimproved road networks, especially in the forest regions of the Soviet Union. Some of these areas are rail-served, and support bases could be established there.

48. The Soviets have used both prepared and unprepared areas as launch points for the

SS-12 Scaleboard. Initially the TELs were used on concrete pads within the permanent facilities. Later operations shifted to isolated field positions and now the permanent sites apparently are being utilized as support bases, rather than primary launch areas (see Figure 12).

#### Shelter-Based and Rail-Mobile Concepts

49. The US has considered a shelter-based mobile system, but there is no clear evidence to indicate Soviet interest in such a system. This concept involves the use of hundreds of shelters among which a smaller number of mobile ICBMs would be constantly rotated. The "shell game" approach is intended to enhance the survivability of a mobile ICBM force.

50. There also is no clear evidence to suggest that the Soviets are considering a rail-mobile concept.

#### FACTORS AFFECTING THE SOVIET DECISION TO DEPLOY A LAND-MOBILE ICBM

51. The deployment of a mobile ICBM would be consistent with the USSR's effort to modernize its strategic missile force and to make it less vulnerable to attack. Such deployment would complicate US targeting and monitoring programs. The Soviets probably realize that a mobile ICBM force of several

~~Top Secret~~

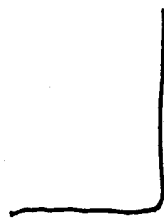
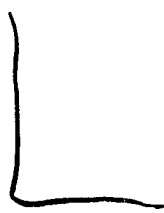

~~Top Secret~~

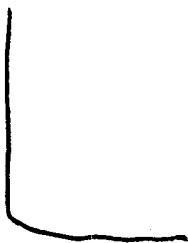
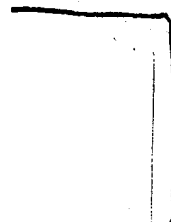
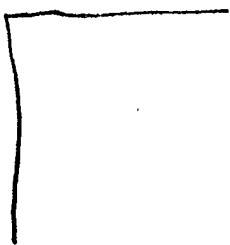

~~PGS 880100-74~~

~~Top Secret~~

hundred launchers would not significantly alter the strategic balance; however, they would view such a force as adding to their deterrent capabilities.

52. Even if the mobile ICBM development program is successful, there are other factors the Soviets would consider before making a decision on deployment. They certainly would weigh the benefits against the costs—political, operational, technical and economic.

#### Incentives for Deployment

53. The principal incentive for deploying a strategic missile system in a mobile mode is to increase its survivability. Because a mobile system can move to and occupy any launch position within its radius of operation in a random fashion, its location at any given time would be difficult for an opponent to predict for targeting purposes. Extensive real-time satellite reconnaissance coverage would help to monitor the movements of a mobile missile force, but surreptitious movement could be accomplished at night, under cloud cover, or by the use of camouflage. In view of US interest in improving its capabilities against hardened targets, deployment of a mobile ICBM might be attractive to the Soviets as a supplement to other measures to increase the survivability of their ICBM force.

54. The Soviets may also view deployment of a mobile ICBM as a hedge against the possible lapse of the Interim Agreement in 1977. The development of a mobile system would provide them with a survivable force available for deployment in the event of lapse or abrogation of the agreement.

55. Institutional momentum may have contributed to the development of the SS-X-16 in a mobile version and may also militate for its deployment. The missile was under development several years prior to the signing of the Interim Agreement and its advanced stage

of development undoubtedly was a consideration in the Soviet refusal to ban mobile ICBMs. Institutional considerations might influence the Soviet decision on deployment of a mobile ICBM, especially the momentum generated in the military and in various ministries responsible for developing and producing the missile.

56. Finally, the Soviets may see the potential deployment of a mobile ICBM as a bargaining chip in SAL negotiations to break US intransigence over issues they deem crucial.

#### Considerations Militating Against Deployment

57. The key negative consideration in the Soviet deliberations seems clear: how would deployment of a land-mobile ICBM affect the SALT agreements and detente? Because the Interim Offensive Agreement was predicated upon a freeze in the number of fixed land-based ICBM launchers in the period mid-1972 to October 1977, the Soviets might believe that to field a mobile system before 1977 would risk US withdrawal from the arms agreement. As noted earlier, on May 20, 1972 the US made a unilateral statement against land-mobile ICBM deployment. The Soviets probably believe that this statement is still operative, although publicity that the US might be considering a mobile ICBM could cause the Soviets to question the firmness of the US position.

58. The prospect of technical problems and operational considerations also might work against a decision to deploy a mobile ICBM system. Reliability and accuracy are more difficult to achieve in a mobile missile system than in one that is fixed. At best a mobile SS-X-16 would be effective only against soft targets.

59. Only a portion of a mobile missile force would be available for launch at any

given time, except during periods of crisis, because part of the force would be undergoing maintenance or moving to new positions.

60. Mobile systems require more maintenance than fixed systems because movement, vibration, and exposure to the elements cause more frequent equipment failures. Logistic support might be a problem because of the distances involved and dispersion of support units.

61. Because of their size and weight, mobile ICBMs could present other operational problems in moving about the countryside. The solid-propellant SS-X-16, for example, is in the 40 metric ton weight class (not including the TEL or resupply vehicle). The standard weight limitation for vehicles on Soviet road networks as a whole is six metric tons per single axle. The tactical Scaleboard transporter-launcher, which has four axles and an estimated gross weight—with the missile—of 31 metric tons, exceeds this limit by about 30 percent. On roads with a "capital" surface (such as cement or asphalt concrete) the single-axle limit is 16 metric tons, but these roads are located in areas of high population density and are heavily traveled—conditions that a missile unit would want to avoid. Operation on unimproved roads would be limited by the load capacity of the bridges. Most of the bridges on Soviet country roads have load limits of from 5 to 7 metric tons. Snow and rain on unimproved roads and launch positions also could present formidable obstacles for movement to assigned launch positions (see Annex C).

62. Physical security is more difficult to maintain with mobile missile units than with fixed-based deployment. Countering this problem requires additional personnel for security purposes and places additional demands on operating crews.

63. Strategic Rocket Forces command and control procedures emphasize positive control to prevent accidental or unauthorized use of nuclear weapons while maintaining a capability for quick strikes. Deployment of a mobile missile poses special command and control problems not experienced with fixed missile systems. It is difficult, for example, to make mobile communications systems as reliable, secure, and redundant as fixed systems and to ensure uninterrupted control of mobile launchers by higher echelons of command. Above all, the command and control system must guard against the possible loss of contact with any portion of the mobile force at a critical moment. Mobile missiles must rely on dispersal and concealment—not hardness or quick reaction—for survivability. Thus, mating warheads to mobile launch vehicles can be (and normally is) delayed until a final decision to employ them has been made, without degrading their capability to retaliate.

64. Finally, if the Soviets were faced with a choice between large numbers of mobile or fixed ICBMs, they would have to consider the comparative costs of the systems. Investment costs for a mobile system—the cost of the missile, launcher set, and related facilities—would not be much higher than those for the fixed-deployment mode. Operating costs for a mobile system, however, would probably be three to four times those for a fixed system. The higher operating cost stems primarily from the need for increased maintenance on both the missile and launcher set and the greater personnel requirements. Other items contributing to the higher cost are increased requirements for transportation, command and control, training, security, and support.

#### POSSIBLE SIZE OF THE FORCE

65. A mobile version of the SS-X-16 could attain initial operational capability in 1977. If the Soviets maximized their development efforts, however, they could deploy their first mobile SS-X-16 units in 1976. They probably would hasten the program only if they saw a more threatening strategic environment and

little chance for a follow-on to the Interim Offensive Agreement.

66. Assuming the Soviets do decide to deploy a mobile version of the SS-X-16, we believe that they would deploy about 30 launchers in 1977 and have some 120 in the field by 1980. If the Soviets were to maximize their efforts, they might deploy about 25 launchers in 1976 and have about 275 by 1980.

~~Top Secret~~

ANNEX A

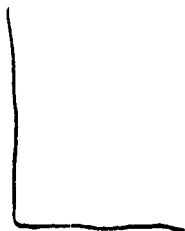
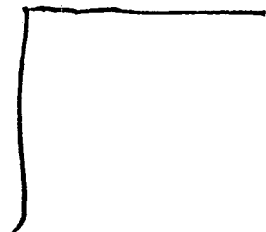



~~Top Secret~~

ANNEX B

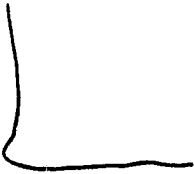
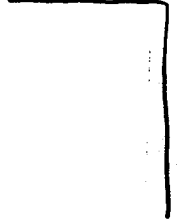
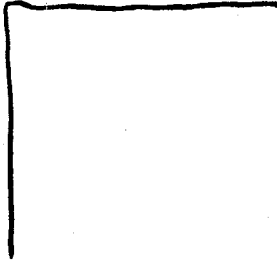

~~TGS 880100-74~~

~~Top Secret~~

[p. 26 blank]

## ANNEX C

### GEOGRAPHIC FACTORS AFFECTING DEPLOYMENT OF LAND-MOBILE ICBM SYSTEMS

1. About one-fourth of the USSR, or over 2 million square miles, is considered suitable for deployment of land-mobile ICBMs. Most Soviet railways and all-weather roads are located in this area, which comprises the European USSR, the North Caucasus, the Ural Mountains, western Siberia, and Kazakhstan (see Figure 13). Also concentrated in this area are most MR/IRBM and ICBM complexes and regional nuclear storage facilities—installations that are dependent on the transportation network.

2. Deployment along main roads and railroads, however, has some drawbacks: the agricultural regions of the southwestern USSR and Soviet Central Asia, are densely populated, posing a security problem. The transportation network tapers off toward the central part of the USSR and becomes only a narrow band along the Trans-Siberian railroad in eastern Siberia.

3. In addition to the principal all-weather roads there are many fair-weather country roads, especially in agricultural and logging areas, that could serve a land-mobile system. These roads and even good trails are suitable for movement of land-mobile systems if the terrain is fairly level. Wherever these roads intersect streams, however, the weight capacity of bridges might become a restrictive factor. Moreover, Soviet country roads are usually little more than graded earth and

become virtually impassable during periods of rain, snow or thaw. The agricultural regions in the Ukraine, in Belorussia, in the Baltic states and south of Moscow, with their network of main and secondary roads, would be suitable for on-road or roadside mobile deployment.

4. Off-road mobile ICBM units also could be deployed away from the main transportation network (see Figure 14 for areas considered suitable). Depending on terrain, areas for off-road deployment are characterized as either good-to-fair or poor.\* In good-to-fair areas, cross-country movement up to 50 nautical miles (nm) from the main transportation network is considered feasible. If these areas also contain an SRF facility, they are considered well suited for mobile deployment. The total area in the good-to-fair category covers about one million square miles. In areas rated poor, a mobile missile unit probably would not move beyond 5 nm from the transportation network or from an SRF facility.

5. Much of the remaining portion of the USSR is considered entirely unsuitable for

\*Good-to-fair areas are those with fairly level terrain, sparse forests, and a minimum of streams, ravines, swamps and loose sand. Areas rated poor in the western USSR are generally dissected by streams and ravines, and characterized by patches of dense forest and occasional swamps. Travel in "poor" areas of Soviet Central Asia would be restricted by loose sand and dunes.

cross-country movement of mobile ICBMs. Large low areas around the Valday Hills, west and north of Moscow, and in the western Ukraine are swampy. Other formidable natural obstacles include loose sand and dunes in Soviet Central Asia; mountains in the southern Ukraine, in the Caucasus, in eastern Siberia, and along the southern border with China and Afghanistan; and the dense forest (taiga) stretching along the entire northern part of the country. Even in these areas, however, deployment off but near the main roads would be possible in places. In addition, deep snow and permafrost make most of eastern Siberia

and the northwestern USSR unsuitable for deployment of mobile ICBMs. In the spring and summer this area becomes a quagmire when the surface layers thaw and the underlying permafrost prevents drainage. Much of this area also has snow accumulating over one foot deep and lasting three to six months of the year.

6. Despite the limitations of climate and terrain, the SS-X-16, with its estimated range of 5,500 nm (see Figure 14), could reach most of the US and all of China from its potential launch sites.



# USSR: Population Density and Transportation

## POPULATION DENSITY

Persons per square mile

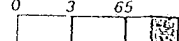

Persons per square kilometer

## TRANSPORTATION

- Road
- - - Road under construction
- + + + Railroad

CAUTION: This map has a scale of approximately 190 miles to an inch. Alignment of both roads and railroads is highly schematic.

BOUNDARY REPRESENTATION  
IS NOT NECESSARILY AUTHORITY

C H I N A

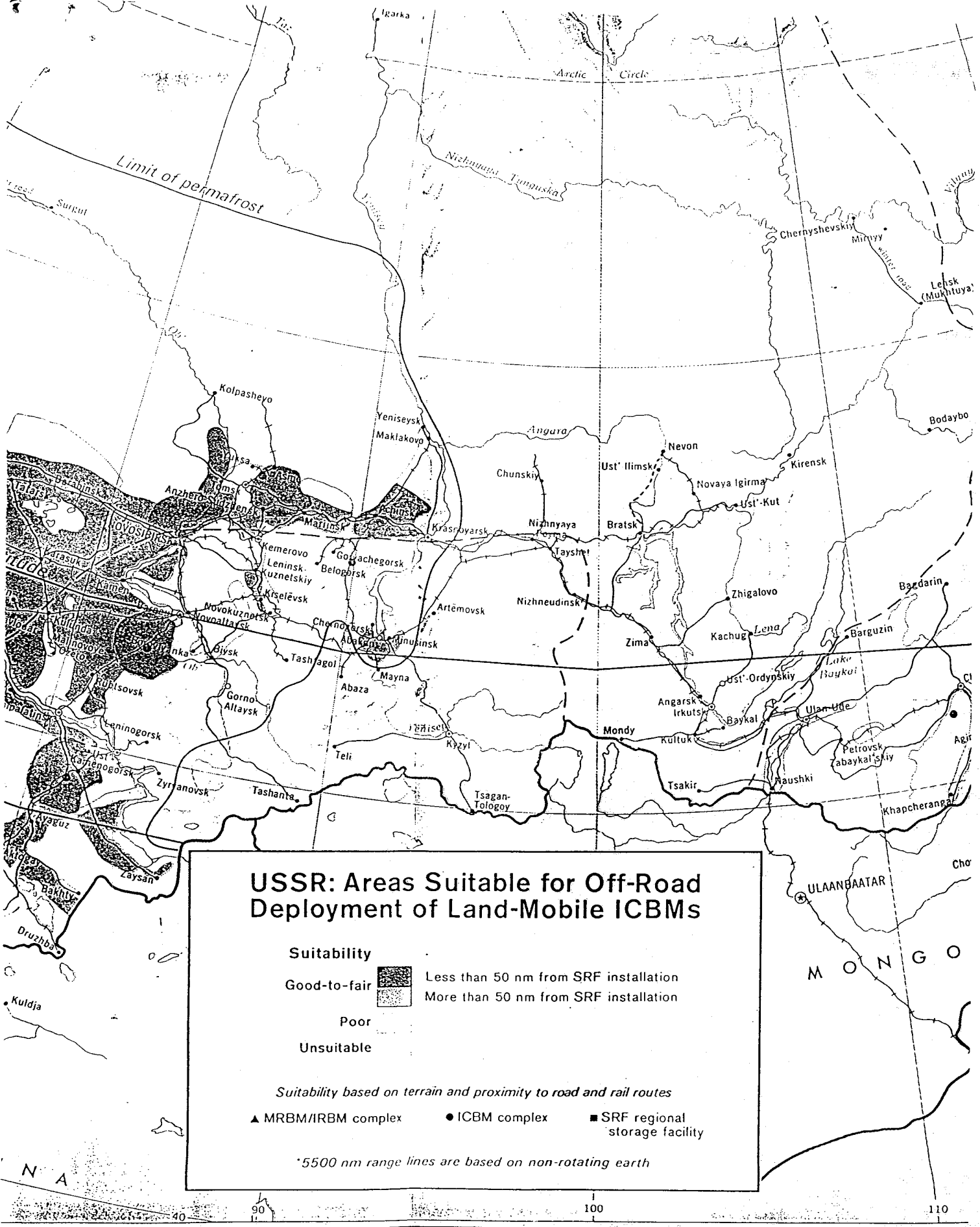

## USSR: Areas Suitable for Off-Road Deployment of Land-Mobile ICBMs

### Suitability

Good-to-fair

Poor

Unsuitable

Less than 50 nm from SRF installation

More than 50 nm from SRF installation

*Suitability based on terrain and proximity to road and rail routes*

▲ MRBM/IRBM complex

● ICBM complex

■ SRF regional storage facility

\*5500 nm range lines are based on non-rotating earth

N A

40

90

100

110

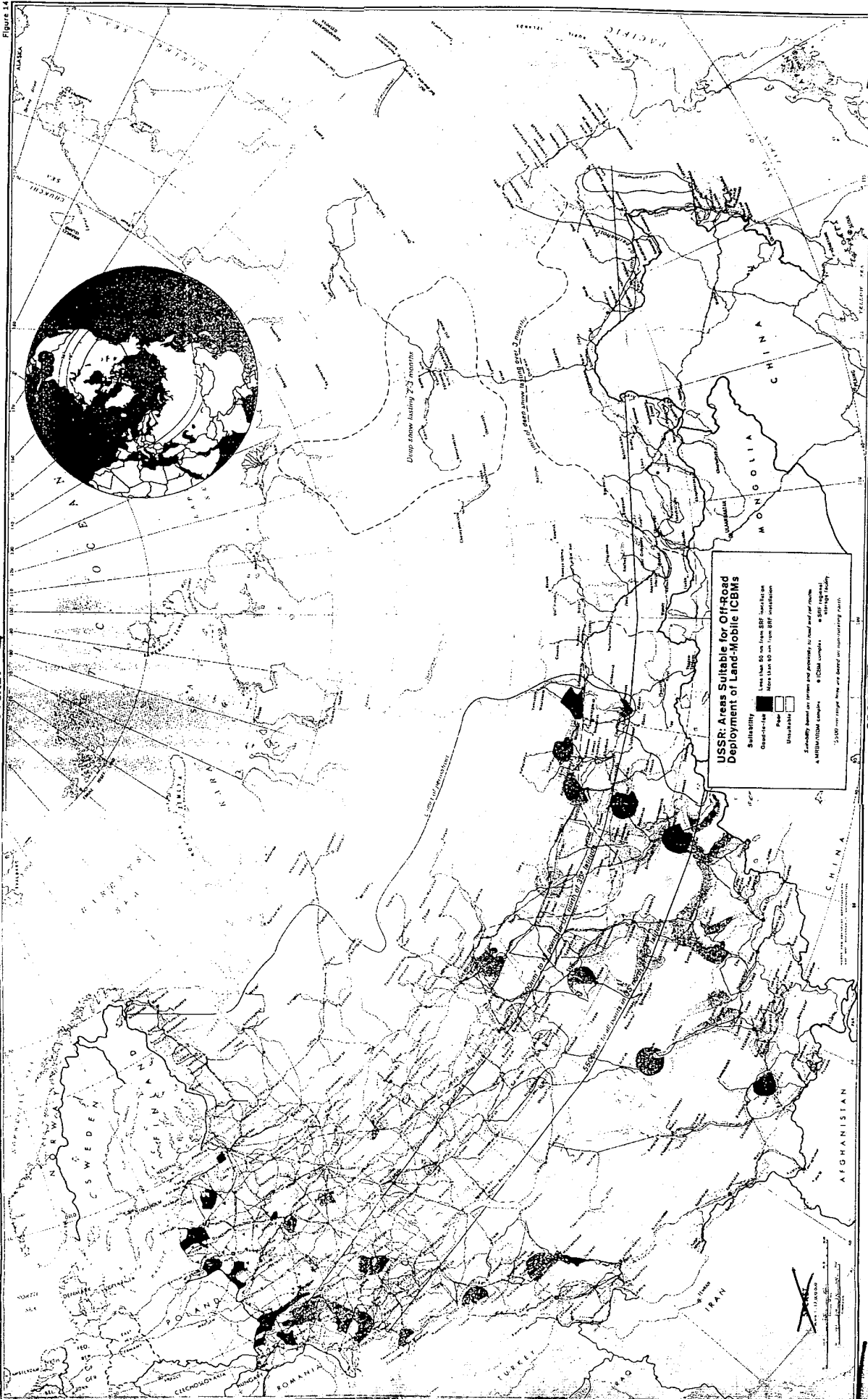
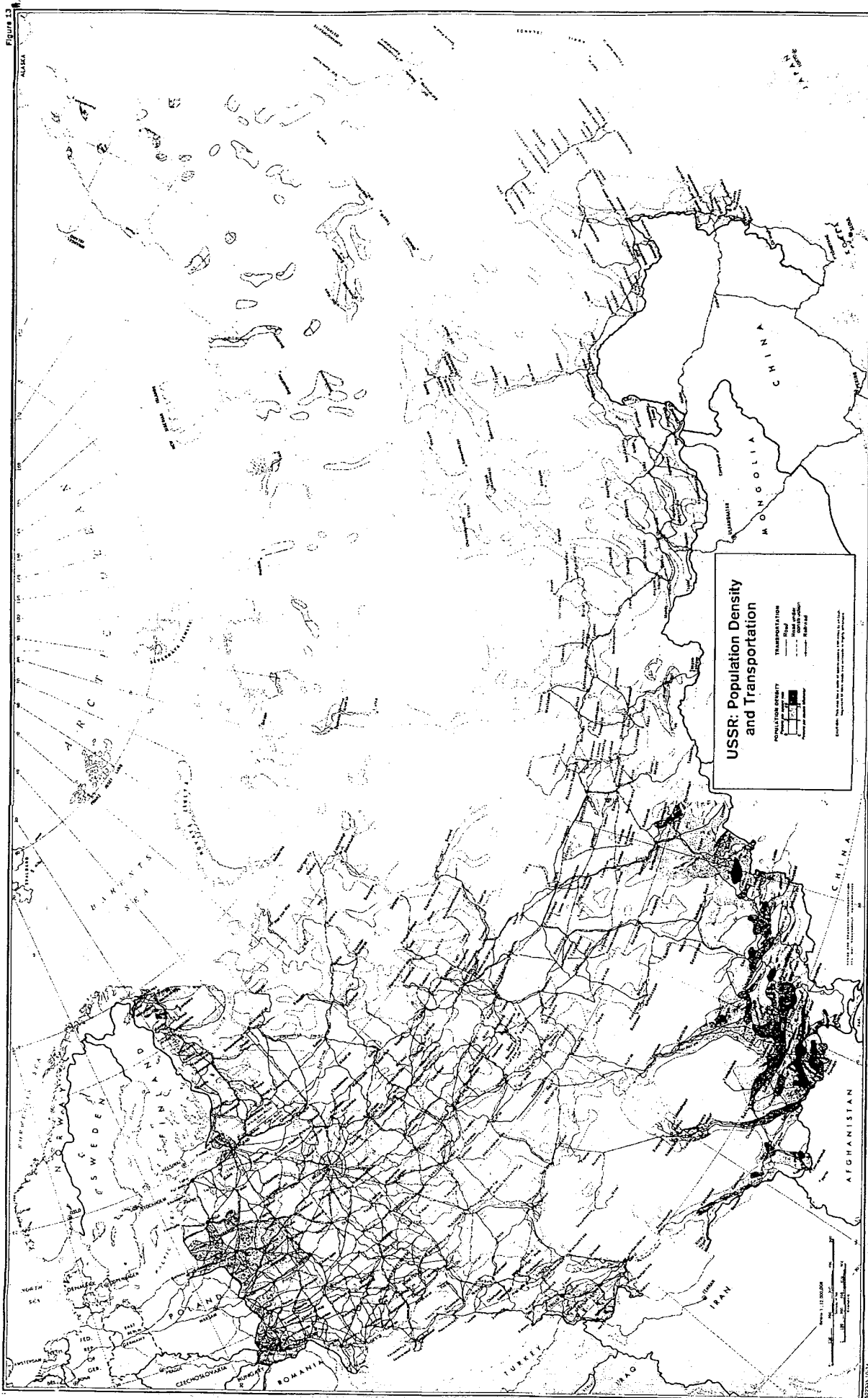

FIGURE 53



~~Top Secret~~

~~Top Secret~~